

Michael Evans
Neil Cracknell
Josian Astruc
Kay Lipson
Peter Jones

Specialist Mathematics

Year 12

Cambridge
Senior
Mathematics
Australian
Curriculum



CAMBRIDGE
UNIVERSITY PRESS

CAMBRIDGE UNIVERSITY PRESS

University Printing House, Cambridge CB2 8BS, United Kingdom

One Liberty Plaza, 20th Floor, New York, NY 10006, USA

477 Williamstown Road, Port Melbourne, VIC 3207, Australia

4843/24, 2nd Floor, Ansari Road, Daryaganj, Delhi – 110002, India

79 Anson Road, #06–04/06, Singapore 079906

Cambridge University Press is part of the University of Cambridge.

It furthers the University's mission by disseminating knowledge in the pursuit of education, learning and research at the highest international levels of excellence.

www.cambridge.org

Information on this title: www.cambridge.org/9781316636107

© Michael Evans, Neil Cracknell, Josian Astruc, Kay Lipson, Peter Jones 2017

This publication is in copyright. Subject to statutory exception and to the provisions of relevant collective licensing agreements, no reproduction of any part may take place without the written permission of Cambridge University Press.

First published 2017

20 19 18 17 16 15 14 13 12 11 10 9 8 7 6 5 4 3 2 1

Cover designed by Loupe Design

Typeset by Jane Pitkethly and Diacritech

Printed in China by C & C Offset Printing Co. Ltd.

A Cataloguing-in-Publication entry is available from the catalogue of the National Library of Australia at www.nla.gov.au

ISBN 978-1-316-63610-7 Paperback

Additional resources for this publication at www.cambridge.edu.au/GO

Reproduction and Communication for educational purposes

The Australian *Copyright Act 1968* (the Act) allows a maximum of one chapter or 10% of the pages of this publication, whichever is the greater, to be reproduced and/or communicated by any educational institution for its educational purposes provided that the educational institution (or the body that administers it) has given a remuneration notice to Copyright Agency Limited (CAL) under the Act.

For details of the CAL licence for educational institutions contact:

Copyright Agency Limited

Level 15, 233 Castlereagh Street

Sydney NSW 2000

Telephone: (02) 9394 7600

Facsimile: (02) 9394 7601

Email: info@copyright.com.au

Reproduction and Communication for other purposes

Except as permitted under the Act (for example a fair dealing for the purposes of study, research, criticism or review) no part of this publication may be reproduced, stored in a retrieval system, communicated or transmitted in any form or by any means without prior written permission. All inquiries should be made to the publisher at the address above.

Cambridge University Press has no responsibility for the persistence or accuracy of URLs for external or third-party Internet websites referred to in this publication and does not guarantee that any content on such websites is, or will remain, accurate or appropriate. Information regarding prices, travel timetables and other factual information given in this work is correct at the time of first printing but Cambridge University Press does not guarantee the accuracy of such information thereafter.

Contents

Introduction	viii
Acknowledgements	ix
An overview of the Cambridge complete teacher and learning resource	x
1 Preliminary topics	1
1A Circular functions	2
1B The sine and cosine rules	14
1C Circles	19
1D Ellipses and hyperbolas	21
1E Parametric equations	28
Review of Chapter 1	37
2 Composite and inverse functions	43
2A The modulus function	44
2B Composite functions	49
2C One-to-one functions	53
2D Inverse functions	55
2E Further composite and inverse functions	66
Review of Chapter 2	70

3	Circular functions	76
	3A The reciprocal circular functions	77
	3B Compound and double angle formulas	84
	3C Inverses of circular functions	89
	3D Solution of equations	96
	Review of Chapter 3	103
4	Revision of Chapters 1–3	111
	4A Short-answer questions	111
	4B Multiple-choice questions	112
	4C Extended-response questions	117
5	Vectors	119
	5A Introduction to vectors	120
	5B Resolution of a vector into rectangular components	131
	5C Scalar product of vectors	143
	5D Vector projections	148
	5E Collinearity	151
	5F Geometric proofs	154
	Review of Chapter 5	160
6	Vector equations of lines and planes	170
	6A Vector equations of lines	171
	6B Intersection of lines and skew lines	179
	6C Vector product	184
	6D Vector equations of planes	188
	6E Distances, angles and intersections	193
	6F Equations of spheres	200
	Review of Chapter 6	202
7	Systems of linear equations	206
	7A Simultaneous linear equations with two variables	207
	7B Simultaneous linear equations with more than two variables	210
	7C Using augmented matrices for systems of equations	214
	Review of Chapter 7	222
8	Complex numbers	227
	8A Starting to build the complex numbers	228
	8B Modulus, conjugate and division	236
	8C The polar form of a complex number	241

8D	Basic operations on complex numbers in polar form	246
8E	Solving quadratic equations over the complex numbers	252
8F	Solving polynomial equations over the complex numbers	256
8G	Using De Moivre's theorem to solve equations	263
8H	Sketching subsets of the complex plane	266
	Review of Chapter 8	272
9	Revision of Chapters 5–8	280
9A	Short-answer questions	280
9B	Multiple-choice questions	283
9C	Extended-response questions	290
10	Differentiation and rational functions	297
10A	Differentiation	298
10B	Derivatives of $x = f(y)$	304
10C	Derivatives of inverse circular functions	308
10D	Related rates	313
10E	Rational functions	321
10F	Implicit differentiation	330
	Review of Chapter 10	336
11	Techniques of integration	345
11A	Antidifferentiation	346
11B	Antiderivatives involving inverse circular functions	354
11C	Integration by substitution	356
11D	Definite integrals by substitution	362
11E	Use of trigonometric identities for integration	364
11F	Partial fractions	367
11G	Integration by parts	375
11H	Further techniques and miscellaneous exercises	378
	Review of Chapter 11	382
12	Applications of integration	386
12A	The fundamental theorem of calculus	387
12B	Area of a region between two curves	393
12C	Integration using a CAS calculator	400
12D	Volumes of solids of revolution	406
12E	The exponential probability distribution	414
	Review of Chapter 12	419

13	Differential equations	429
13A	An introduction to differential equations	430
13B	Differential equations involving a function of the independent variable	434
13C	Differential equations involving a function of the dependent variable	442
13D	Applications of differential equations	444
13E	The logistic differential equation	455
13F	Separation of variables	458
13G	Differential equations with related rates	462
13H	Using a definite integral to solve a differential equation	467
13I	Using Euler's method to solve a differential equation	469
13J	Slope field for a differential equation	475
	Review of Chapter 13	478
14	Kinematics	487
14A	Position, velocity and acceleration	488
14B	Constant acceleration	503
14C	Velocity–time graphs	508
14D	Differential equations of the form $v = f(x)$ and $a = f(v)$	515
14E	Other expressions for acceleration	519
14F	Simple harmonic motion	524
	Review of Chapter 14	530
15	Revision of Chapters 10–14	539
15A	Short-answer questions	539
15B	Multiple-choice questions	541
15C	Extended-response questions	555
16	Vector functions	562
16A	Vector functions	563
16B	Position vectors as a function of time	567
16C	Vector calculus	573
16D	Velocity and acceleration for motion along a curve	579
16E	Projectile motion	585
16F	Circular motion	589
	Review of Chapter 16	593

17	Dynamics	601
	17A Force	602
	17B Newton's laws of motion	611
	17C Resolution of forces and inclined planes	620
	17D Connected particles	626
	17E Variable forces	631
	17F Equilibrium	634
	17G Vector functions	640
	Review of Chapter 17	644
18	Revision of Chapters 16–17	652
	18A Short-answer questions	652
	18B Multiple-choice questions	655
	18C Extended-response questions	661
19	Linear combinations of random variables and distribution of sample means	667
	19A Linear combinations of random variables	668
	19B Linear combinations of independent normal random variables	676
	19C Simulating the distribution of sample means	678
	19D The distribution of the sample mean of a normally distributed random variable	684
	19E The central limit theorem	690
	19F Confidence intervals for the population mean	696
	Review of Chapter 19	705
20	Revision of Chapters 1–19	712
	20A Short-answer questions	712
	20B Multiple-choice questions	715
	20C Extended-response questions	721
	Glossary	728
	Answers	738

Included in the Interactive Textbook and PDF textbook only
Appendix B: Guide to the TI-Nspire CAS Calculator (OS4) in Senior Mathematics
Appendix C: Guide to the Casio ClassPad II CAS Calculator in Senior Mathematics

Introduction

Cambridge Specialist Mathematics Australian Curriculum Year 12 provides a complete teaching and learning resource for the Australian Curriculum and the State-specific variations. It has been written with understanding as its chief aim and with ample practise offered through the worked examples and exercises. All the work has been trialled in the classroom, and the approaches offered are based on classroom experience and the responses of teachers to earlier versions of this book. *Specialist Mathematics Year 12* covers Units 3 & 4 of the Specialist Mathematics syllabus.

The book has been carefully prepared to reflect the Australian Curriculum. Some topics in statistics, vectors and systems of equations may be new to some, and for these topics particular care has been taken to provide the right depth of coverage and interpretation of the curriculum.

The book contains five revision chapters. These provide technology-free multiple-choice questions and extended-response questions.

The TI-Nspire calculator examples and instructions have been completed by Russell Brown, and those for the Casio ClassPad have been completed by Maria Schaffner.

The integration of the features of the textbook and the new digital components of the package, powered by Cambridge HOTmaths, are illustrated in the next two pages.

About Cambridge HOTmaths

Cambridge HOTmaths is a comprehensive, award-winning mathematics learning system – an interactive online maths learning, teaching and assessment resource for students and teachers, for individuals or whole classes, for school and at home. Its digital engine, or platform, is used to host and power the Interactive Textbook and the Online Teaching Suite. All this is included in the price of the textbook.

Consultants

The authors and publisher wish to thank Jan Honnens of Christ Church Grammar School, Perth for advice on the preparation of this edition.

Acknowledgements

The author and publisher wish to thank the following sources for permission to reproduce material:

Cover: Giant Origami cover art by Coco Sato <http://cocosato.co.uk>.

Images: Used under licence 2016 from Shutterstock.com / kidstudio852, Chapter 1 Opener / Shots Studio, Chapter 5 Opener / Melpomene, Chapter 3 Opener / tashechka, Chapter 4 Opener / Redcollegiya, Chapter 9 Opener / Attitude, Chapter 10 Opener & Chapter 15 Opener / Kittikorn Phongok, Chapter 12 Opener / Karma3, Chapter 13 Opener / Berezina, Chapter 16, 2, 7 Opener / maralova / Toria, Chapter 19 Opener / Oaurea, Chapter 11 Opener / Apostrophe, Chapter 8 Opener.

Every effort has been made to trace and acknowledge copyright. The publisher apologises for any accidental infringement and welcomes information that would redress this situation.

An overview of the Cambridge complete teacher and learning resource

For more detail, see the guide in the online Interactive Textbook

Skillsheet

Icons for skillsheets and worksheets



Icons for videos



Icons for interactives

Answers

PRINT TEXTBOOK

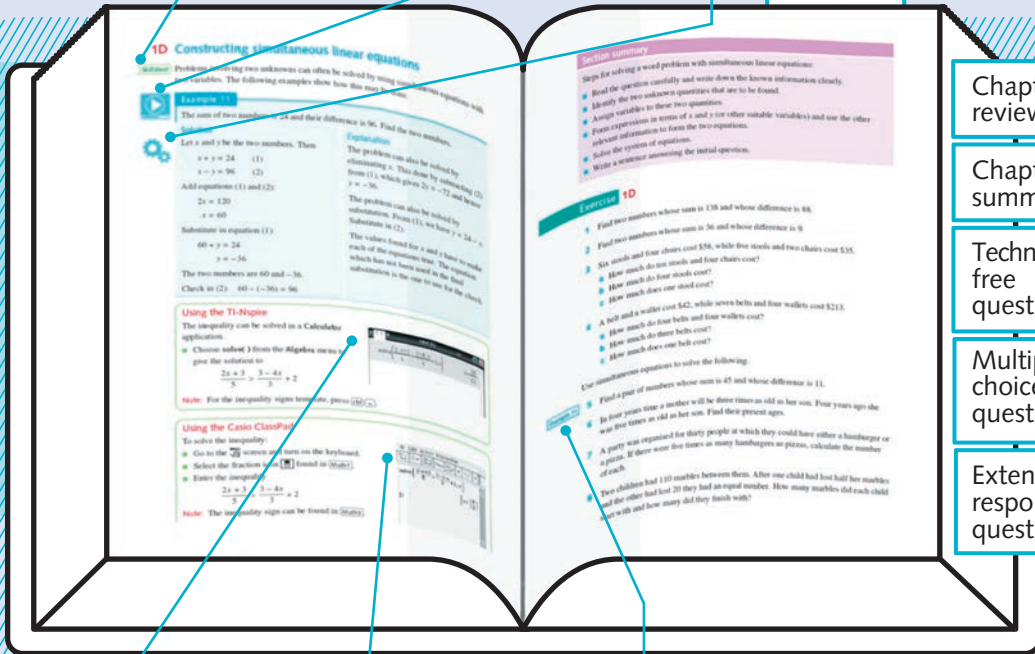

Chapter reviews

Chapter summaries

Technology free questions

Multiple choice questions

Extended response questions

TI-Nspire OS4.0 examples

Casio ClassPad II examples

Questions linked to examples



PDF TEXTBOOK

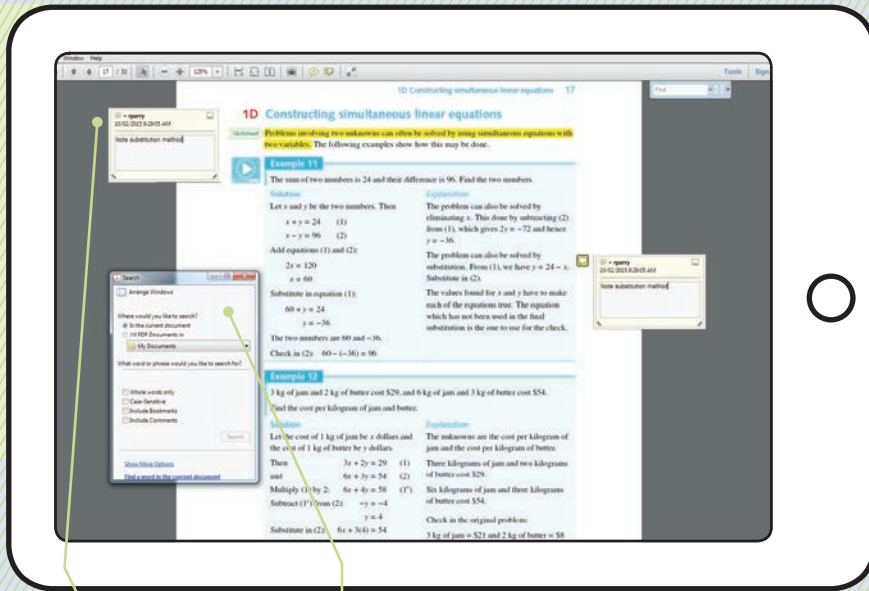

Downloadable

Included with print textbook and interactive textbook

Note-taking

Search functions

Definitions of terms display on rollover



Automated practice quizzes

Interactive navigation and searches

Tasks sent by teacher

Online tests sent by teacher

Interactive widgets



Video worked examples



Printable worksheets

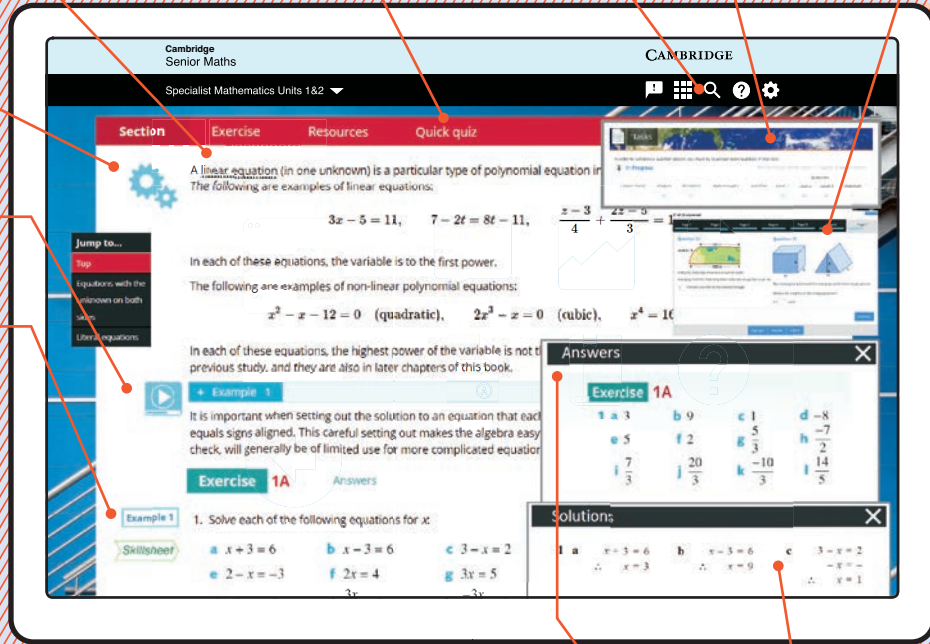

INTERACTIVE TEXTBOOK
POWERED BY HOTMATS

Answers in pop-ups



Worked solutions (if enabled by teacher)

Class reports

Student reports

Teacher's copy of interactive textbook

Tasks sent to students

Test generator

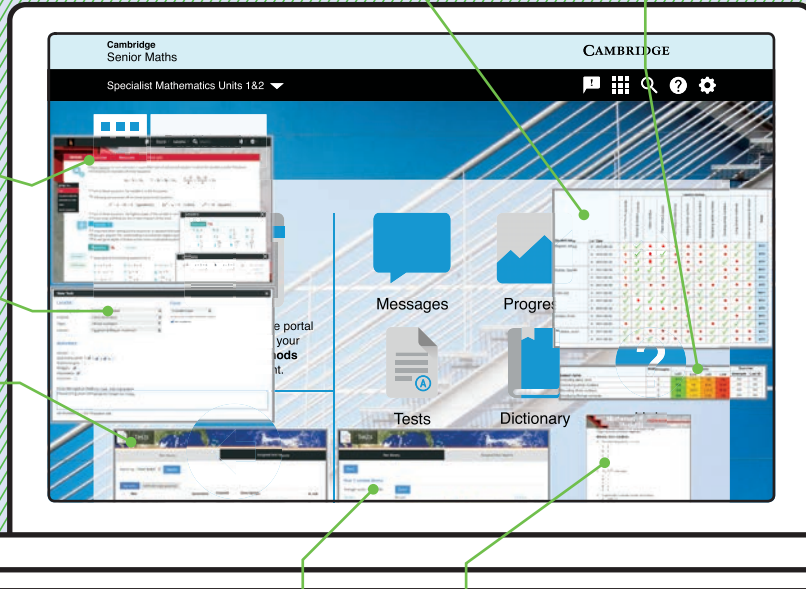

ONLINE TEACHING SUITE
POWERED BY HOTMATS

Student results



Printable worksheets and support documents

1 Preliminary topics

Objectives

- ▶ To revise the properties of **sine**, **cosine** and **tangent**.
- ▶ To revise the **sine rule** and the **cosine rule**.
- ▶ To revise Cartesian equations for **circles**.
- ▶ To sketch graphs of **ellipses** from their Cartesian equations.
- ▶ To sketch graphs of **hyperbolas** from their Cartesian equations.
- ▶ To consider asymptotic behaviour of hyperbolas.
- ▶ To use **parametric equations** to describe curves in the plane.

We begin this chapter with revision of trigonometry and the circular functions.

We then consider the Cartesian equations of three important types of curves in the plane: circles, ellipses and hyperbolas. These curves are called *conic sections*, because they arise as the boundary of a cross-section through a pair of cones. We will use these curves in our study of vector calculus in Chapter 16.

We also introduce parametric equations for curves in the plane. For example, the unit circle can be described by the pair of parametric equations

$$x = \cos t \quad \text{and} \quad y = \sin t \quad \text{for } t \in \mathbb{R}$$

Parametric equations will be used in various contexts throughout this book:

- In Chapter 6, they are used to describe lines in three-dimensional space.
- In Chapter 7, they are used to describe the solutions of systems of linear equations.
- In Chapter 16, they are used in our study of motion along a curve.

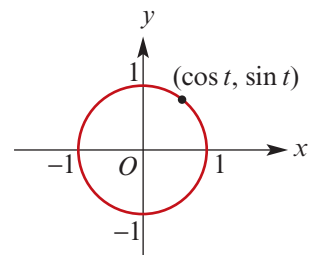

1A Circular functions

► Defining sine, cosine and tangent



The unit circle is a circle of radius 1 with centre at the origin. It is the graph of the relation $x^2 + y^2 = 1$.

We can define the sine and cosine of any angle by using the unit circle.

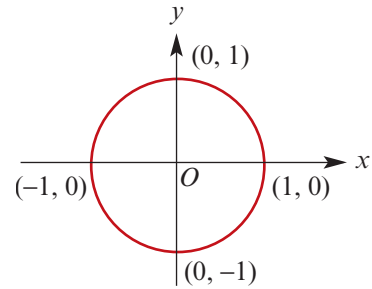

Definition of sine and cosine

For each angle θ° , there is a point P on the unit circle as shown. The angle is measured anticlockwise from the positive direction of the x -axis.

- $\cos(\theta^\circ)$ is defined as the x -coordinate of the point P
- $\sin(\theta^\circ)$ is defined as the y -coordinate of the point P

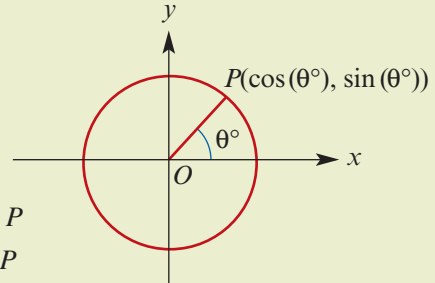

For example:

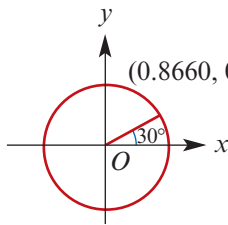

$$\sin 30^\circ = 0.5 \quad (\text{exact value})$$

$$\cos 30^\circ = \frac{\sqrt{3}}{2} \approx 0.8660$$

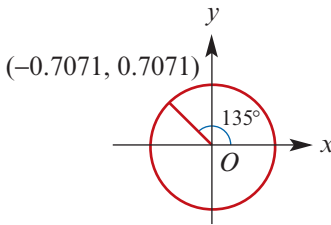

$$\sin 135^\circ = \frac{1}{\sqrt{2}} \approx 0.7071$$

$$\cos 135^\circ = \frac{-1}{\sqrt{2}} \approx -0.7071$$

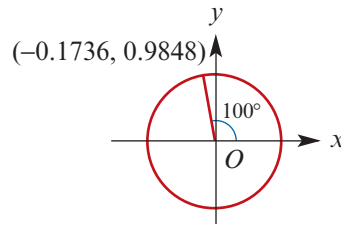

$$\sin 100^\circ \approx 0.9848$$

$$\cos 100^\circ \approx -0.1736$$

Definition of tangent

$$\tan(\theta^\circ) = \frac{\sin(\theta^\circ)}{\cos(\theta^\circ)}$$

The value of $\tan(\theta^\circ)$ can be illustrated geometrically through the unit circle.

By considering similar triangles OPP' and OTT' , it can be seen that

$$\frac{TT'}{OT'} = \frac{PP'}{OP'}$$

i.e. $TT' = \frac{\sin(\theta^\circ)}{\cos(\theta^\circ)} = \tan(\theta^\circ)$

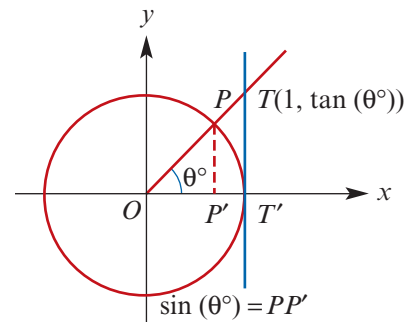

► The trigonometric ratios

For a right-angled triangle OBC , we can construct a similar triangle $OB'C'$ that lies in the unit circle.

From the diagram:

$$B'C' = \sin(\theta^\circ) \quad \text{and} \quad OC' = \cos(\theta^\circ)$$

The similarity factor is the length OB , giving

$$BC = OB \sin(\theta^\circ) \quad \text{and} \quad OC = OB \cos(\theta^\circ)$$

$$\therefore \frac{BC}{OB} = \sin(\theta^\circ) \quad \text{and} \quad \frac{OC}{OB} = \cos(\theta^\circ)$$

This gives the ratio definition of sine and cosine for a right-angled triangle. The naming of sides with respect to an angle θ° is as shown.

$$\sin(\theta^\circ) = \frac{\text{opposite}}{\text{hypotenuse}}$$

$$\cos(\theta^\circ) = \frac{\text{adjacent}}{\text{hypotenuse}}$$

$$\tan(\theta^\circ) = \frac{\text{opposite}}{\text{adjacent}}$$

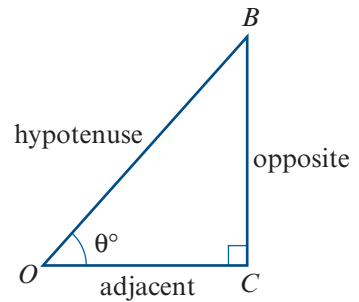
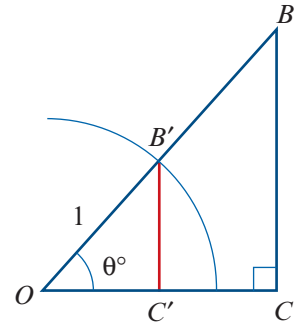

► Definition of a radian

In moving around the unit circle a distance of 1 unit from A to P , the angle POA is defined. The measure of this angle is 1 radian.

One **radian** (written 1^c) is the angle subtended at the centre of the unit circle by an arc of length 1 unit.

Note: Angles formed by moving **anticlockwise** around the unit circle are defined as **positive**; those formed by moving **clockwise** are defined as **negative**.

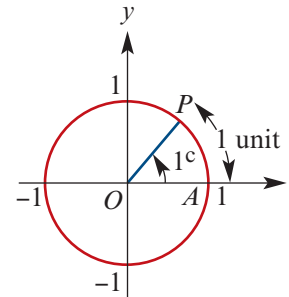

► Degrees and radians

The angle, in radians, swept out in one revolution of a circle is $2\pi^c$.

$$2\pi^c = 360^\circ$$

$$\therefore \pi^c = 180^\circ$$

$$\therefore 1^c = \frac{180^\circ}{\pi} \quad \text{or} \quad 1^\circ = \frac{\pi^c}{180}$$

Usually the symbol for radians, c , is omitted. Any angle is assumed to be measured in radians unless indicated otherwise.

The following table displays the conversions of some special angles from degrees to radians.

Angle in degrees	0°	30°	45°	60°	90°	180°	360°
Angle in radians	0	$\frac{\pi}{6}$	$\frac{\pi}{4}$	$\frac{\pi}{3}$	$\frac{\pi}{2}$	π	2π

Some values for the trigonometric functions are given in the following table.

x	$\sin x$	$\cos x$	$\tan x$
0	0	1	0
$\frac{\pi}{6}$	$\frac{1}{2}$	$\frac{\sqrt{3}}{2}$	$\frac{1}{\sqrt{3}}$
$\frac{\pi}{4}$	$\frac{1}{\sqrt{2}}$	$\frac{1}{\sqrt{2}}$	1
$\frac{\pi}{3}$	$\frac{\sqrt{3}}{2}$	$\frac{1}{2}$	$\sqrt{3}$
$\frac{\pi}{2}$	1	0	undefined

► The graphs of sine and cosine

A sketch of the graph of

$$f: \mathbb{R} \rightarrow \mathbb{R}, f(x) = \sin x$$

is shown opposite.

As $\sin(x + 2\pi) = \sin x$ for all $x \in \mathbb{R}$, the sine function is **periodic**. The period is 2π . The amplitude is 1.

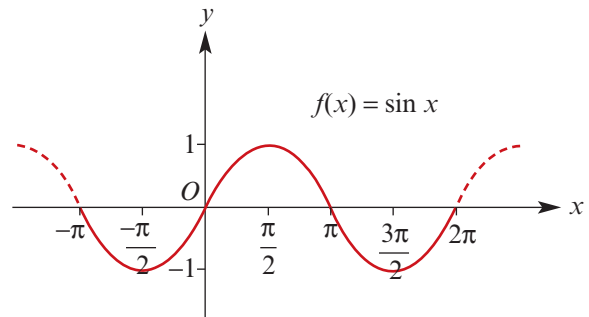

A sketch of the graph of

$$f: \mathbb{R} \rightarrow \mathbb{R}, f(x) = \cos x$$

is shown opposite.

The period of the cosine function is 2π . The amplitude is 1.

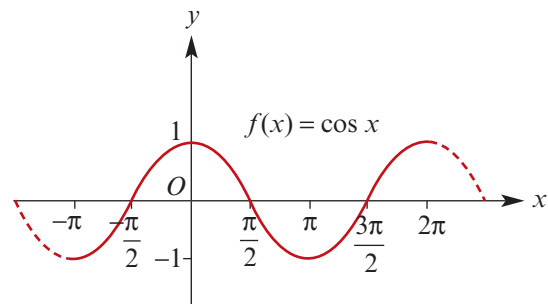

For the graphs of $y = a \cos(nx)$ and $y = a \sin(nx)$, where $a > 0$ and $n > 0$:

- Period = $\frac{2\pi}{n}$
- Amplitude = a
- Range = $[-a, a]$

► Symmetry properties of sine and cosine

The following results may be obtained from the graphs of the functions or from the unit-circle definitions:

$$\begin{array}{ll} \sin(\pi - \theta) = \sin \theta & \cos(\pi - \theta) = -\cos \theta \\ \sin(\pi + \theta) = -\sin \theta & \cos(\pi + \theta) = -\cos \theta \\ \sin(2\pi - \theta) = -\sin \theta & \cos(2\pi - \theta) = \cos \theta \\ \sin(-\theta) = -\sin \theta & \cos(-\theta) = \cos \theta \\ \sin(\theta + 2n\pi) = \sin \theta & \cos(\theta + 2n\pi) = \cos \theta \quad \text{for } n \in \mathbb{Z} \\ \sin\left(\frac{\pi}{2} - \theta\right) = \cos \theta & \cos\left(\frac{\pi}{2} - \theta\right) = \sin \theta \end{array}$$

Example 1

- a** Convert 135° to radians. **b** Convert 1.5° to degrees, correct to two decimal places.

Solution

a $135^\circ = \frac{135 \times \pi^\circ}{180} = \frac{3\pi^\circ}{4}$ **b** $1.5^\circ = \frac{1.5 \times 180^\circ}{\pi} = 85.94^\circ$ to two decimal places

Example 2

Find the exact value of:

- a** $\sin 150^\circ$ **b** $\cos(-585^\circ)$

Solution

a $\sin 150^\circ = \sin(180^\circ - 150^\circ)$
 $= \sin 30^\circ$
 $= \frac{1}{2}$

b $\cos(-585^\circ) = \cos 585^\circ$
 $= \cos(585^\circ - 360^\circ)$
 $= \cos 225^\circ$
 $= -\cos 45^\circ$
 $= -\frac{1}{\sqrt{2}}$

Example 3

Find the exact value of:

- a** $\sin\left(\frac{11\pi}{6}\right)$ **b** $\cos\left(\frac{-45\pi}{6}\right)$

Solution

a $\sin\left(\frac{11\pi}{6}\right) = \sin\left(2\pi - \frac{\pi}{6}\right)$
 $= -\sin\left(\frac{\pi}{6}\right)$
 $= -\frac{1}{2}$

b $\cos\left(\frac{-45\pi}{6}\right) = \cos(-7\frac{1}{2} \times \pi)$
 $= \cos\left(\frac{\pi}{2}\right)$
 $= 0$

► The Pythagorean identity

For any value of θ :

$$\sin^2 \theta + \cos^2 \theta = 1$$

Example 4

If $\sin(x^\circ) = 0.3$ and $0 < x < 90$, find:

a $\cos(x^\circ)$

b $\tan(x^\circ)$

Solution

a $\sin^2(x^\circ) + \cos^2(x^\circ) = 1$

$$0.09 + \cos^2(x^\circ) = 1$$

$$\cos^2(x^\circ) = 0.91$$

$$\therefore \cos(x^\circ) = \pm\sqrt{0.91}$$

Since $0 < x < 90$, this gives

$$\cos(x^\circ) = \sqrt{0.91} = \sqrt{\frac{91}{100}} = \frac{\sqrt{91}}{10}$$

b $\tan(x^\circ) = \frac{\sin(x^\circ)}{\cos(x^\circ)} = \frac{0.3}{\sqrt{0.91}}$

$$= \frac{3}{\sqrt{91}}$$

$$= \frac{3\sqrt{91}}{91}$$

► Solution of equations involving sine and cosine

If a trigonometric equation has a solution, then it will have a corresponding solution in each ‘cycle’ of its domain. Such an equation is solved by using the symmetry of the graph to obtain solutions within one ‘cycle’ of the function. Other solutions may be obtained by adding multiples of the period to these solutions.

Example 5

The graph of $y = f(x)$ for

$$f: [0, 2\pi] \rightarrow \mathbb{R}, f(x) = \sin x$$

is shown.

For each pronumeral marked on the x -axis, find the other x -value which has the same y -value.

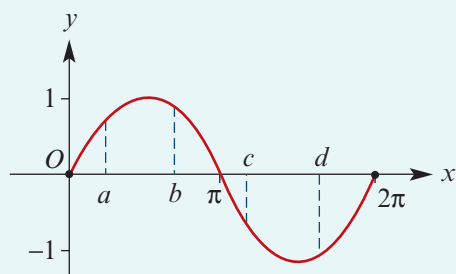

Solution

For $x = a$, the other value is $\pi - a$.

For $x = b$, the other value is $\pi - b$.

For $x = c$, the other value is $2\pi - (c - \pi) = 3\pi - c$.

For $x = d$, the other value is $\pi + (2\pi - d) = 3\pi - d$.

Example 6

Solve the equation $\sin\left(2x + \frac{\pi}{3}\right) = \frac{1}{2}$ for $x \in [0, 2\pi]$.

Solution

Let $\theta = 2x + \frac{\pi}{3}$. Note that

$$\begin{aligned} 0 \leq x \leq 2\pi &\Leftrightarrow 0 \leq 2x \leq 4\pi \\ &\Leftrightarrow \frac{\pi}{3} \leq 2x + \frac{\pi}{3} \leq \frac{13\pi}{3} \\ &\Leftrightarrow \frac{\pi}{3} \leq \theta \leq \frac{13\pi}{3} \end{aligned}$$

To solve $\sin\left(2x + \frac{\pi}{3}\right) = \frac{1}{2}$ for $x \in [0, 2\pi]$, we first solve $\sin \theta = \frac{1}{2}$ for $\frac{\pi}{3} \leq \theta \leq \frac{13\pi}{3}$.

Consider $\sin \theta = \frac{1}{2}$.

$$\therefore \theta = \frac{\pi}{6} \text{ or } \frac{5\pi}{6} \text{ or } 2\pi + \frac{\pi}{6} \text{ or } 2\pi + \frac{5\pi}{6} \text{ or } 4\pi + \frac{\pi}{6} \text{ or } 4\pi + \frac{5\pi}{6} \text{ or } \dots$$

The solutions $\frac{\pi}{6}$ and $\frac{29\pi}{6}$ are not required, as they lie outside the restricted domain for θ .

For $\frac{\pi}{3} \leq \theta \leq \frac{13\pi}{3}$:

$$\begin{aligned} \theta &= \frac{5\pi}{6} \text{ or } \frac{13\pi}{6} \text{ or } \frac{17\pi}{6} \text{ or } \frac{25\pi}{6} \\ \therefore 2x + \frac{\pi}{6} &= \frac{5\pi}{6} \text{ or } \frac{13\pi}{6} \text{ or } \frac{17\pi}{6} \text{ or } \frac{25\pi}{6} \\ \therefore 2x &= \frac{3\pi}{6} \text{ or } \frac{11\pi}{6} \text{ or } \frac{15\pi}{6} \text{ or } \frac{23\pi}{6} \\ \therefore x &= \frac{\pi}{4} \text{ or } \frac{11\pi}{12} \text{ or } \frac{5\pi}{4} \text{ or } \frac{23\pi}{12} \end{aligned}$$

Using the TI-Nspire

- Ensure your calculator is in radian mode.
(To change the mode, go to $\left[\frac{\square}{\square}\right]$ on $\left[\text{on}\right]$ > **Settings** > **Document Settings**.)
- Complete as shown.

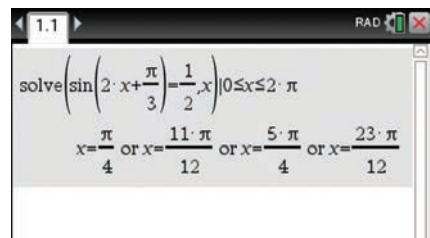

Note: The **Graph** application has its own settings, which are accessed from a **Graph** page using $\left[\text{menu}\right]$ > **Settings**.

Using the Casio ClassPad

- Open the $\sqrt{\alpha}$ application.
- Ensure your calculator is in radian mode (with **Rad** in the status bar at the bottom of the main screen).
- Enter and highlight

$$\sin\left(2x + \frac{\pi}{3}\right) = \frac{1}{2} \mid 0 \leq x \leq 2\pi$$

- Select **Interactive** > **Equation/Inequality** > **solve**.

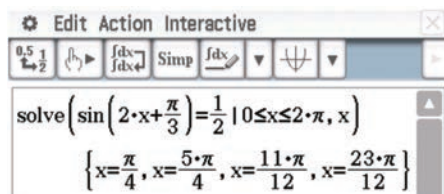

► Transformations of the graphs of sine and cosine

The graphs of functions with rules of the form

$$f(x) = a \sin(nx + \varepsilon) + b \quad \text{and} \quad f(x) = a \cos(nx + \varepsilon) + b$$

can be obtained from the graphs of $y = \sin x$ and $y = \cos x$ by transformations.

Example 7

Sketch the graph of the function

$$h: [0, 2\pi] \rightarrow \mathbb{R}, \quad h(x) = 3 \cos\left(2x + \frac{\pi}{3}\right) + 1$$

Solution

We can write $h(x) = 3 \cos\left(2\left(x + \frac{\pi}{6}\right)\right) + 1$.

The graph of $y = h(x)$ is obtained from the graph of $y = \cos x$ by:

- a dilation of factor $\frac{1}{2}$ from the y -axis
- a dilation of factor 3 from the x -axis
- a translation of $\frac{\pi}{6}$ units in the negative direction of the x -axis
- a translation of 1 unit in the positive direction of the y -axis.

First apply the two dilations to the graph of $y = \cos x$.

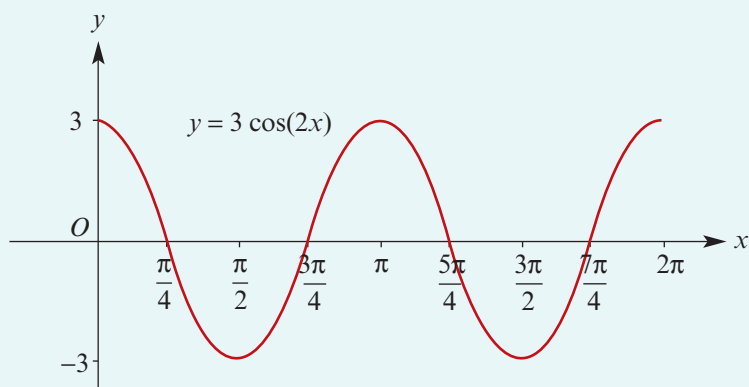

Next apply the translation $\frac{\pi}{6}$ units in the negative direction of the x -axis.

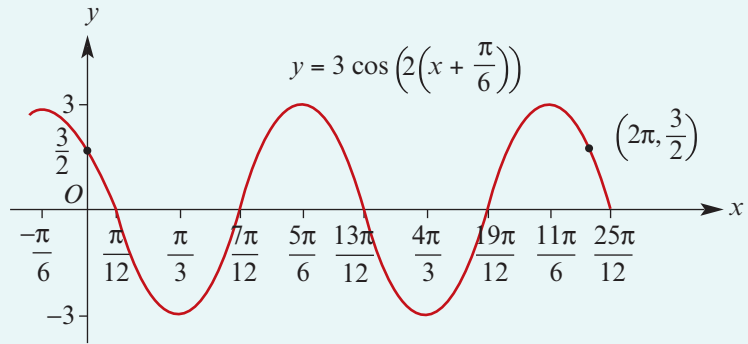

Apply the final translation and restrict the graph to the required domain.

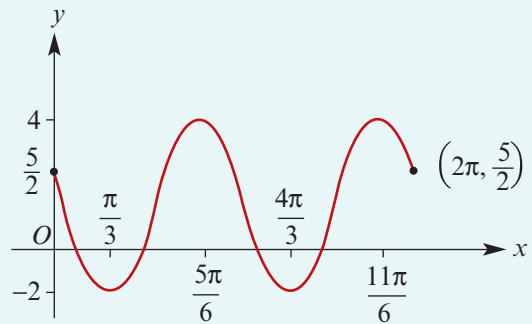

► The graph of the tangent function

A sketch of the graph of $y = \tan \theta$ is shown below.

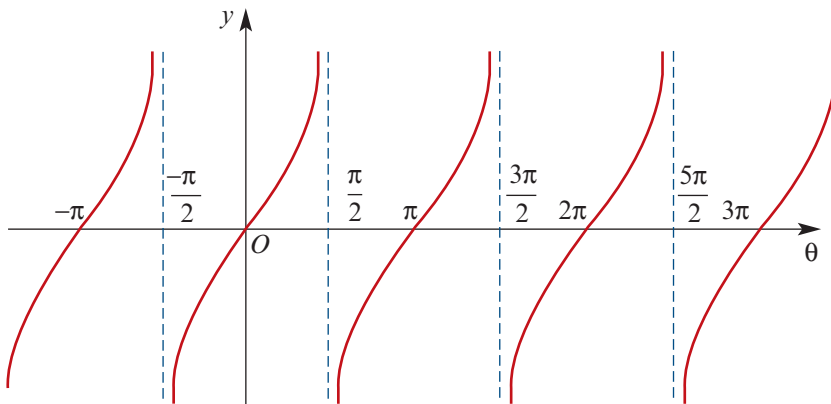

Notes:

- The domain of \tan is $\mathbb{R} \setminus \left\{ \frac{(2k+1)\pi}{2} : k \in \mathbb{Z} \right\}$.
- The range of \tan is \mathbb{R} .
- The graph repeats itself every π units, i.e. the period of \tan is π .
- The vertical asymptotes have equations $\theta = \frac{(2k+1)\pi}{2}$, where $k \in \mathbb{Z}$.

Using the TI-Nspire

Open a **Graphs** application and define $f1(x) = \tan(x)$.

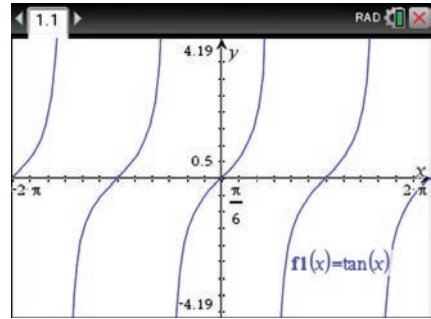

Using the Casio ClassPad

- Open the menu ; select **Graph & Table** .
- Enter $\tan(x)$ in $y1$, tick the box and tap .
- If necessary, select **Zoom > Quick > Quick Trig** or tap to manually adjust the window.

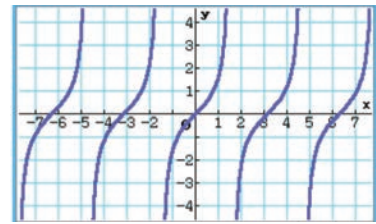
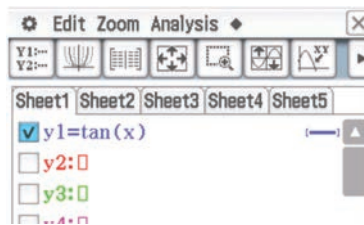

► Symmetry properties of tangent

The following results are obtained from the definition of \tan :

$$\tan(\pi - \theta) = -\tan \theta$$

$$\tan(2\pi - \theta) = -\tan \theta$$

$$\tan(\pi + \theta) = \tan \theta$$

$$\tan(-\theta) = -\tan \theta$$

Example 8

Find the exact value of:

a $\tan 330^\circ$

b $\tan\left(\frac{4\pi}{3}\right)$

Solution

$$\begin{aligned} \mathbf{a} \quad \tan 330^\circ &= \tan(360^\circ - 30^\circ) \\ &= -\tan 30^\circ \\ &= -\frac{1}{\sqrt{3}} \end{aligned}$$

$$\begin{aligned} \mathbf{b} \quad \tan\left(\frac{4\pi}{3}\right) &= \tan\left(\pi + \frac{\pi}{3}\right) \\ &= \tan\left(\frac{\pi}{3}\right) \\ &= \sqrt{3} \end{aligned}$$

► Solution of equations involving tangent

The method here is similar to that used for solving equations involving sin and cos, except that only one solution needs to be found then all other solutions are one period length apart.

Example 9

Solve the following equations:

a $\tan x = -1$ for $x \in [0, 4\pi]$

b $\tan(2x - \pi) = \sqrt{3}$ for $x \in [-\pi, \pi]$

Solution

a $\tan x = -1$

Now $\tan\left(\frac{3\pi}{4}\right) = -1$

$$\therefore x = \frac{3\pi}{4} \text{ or } \frac{3\pi}{4} + \pi \text{ or } \frac{3\pi}{4} + 2\pi \text{ or } \frac{3\pi}{4} + 3\pi$$

$$\therefore x = \frac{3\pi}{4} \text{ or } \frac{7\pi}{4} \text{ or } \frac{11\pi}{4} \text{ or } \frac{15\pi}{4}$$

b Let $\theta = 2x - \pi$. Then

$$-\pi \leq x \leq \pi \Leftrightarrow -2\pi \leq 2x \leq 2\pi$$

$$\Leftrightarrow -3\pi \leq 2x - \pi \leq \pi$$

$$\Leftrightarrow -3\pi \leq \theta \leq \pi$$

To solve $\tan(2x - \pi) = \sqrt{3}$, we first solve $\tan \theta = \sqrt{3}$.

$$\theta = \frac{\pi}{3} \text{ or } \frac{\pi}{3} - \pi \text{ or } \frac{\pi}{3} - 2\pi \text{ or } \frac{\pi}{3} - 3\pi$$

$$\therefore \theta = \frac{\pi}{3} \text{ or } -\frac{2\pi}{3} \text{ or } -\frac{5\pi}{3} \text{ or } -\frac{8\pi}{3}$$

$$\therefore 2x - \pi = \frac{\pi}{3} \text{ or } -\frac{2\pi}{3} \text{ or } -\frac{5\pi}{3} \text{ or } -\frac{8\pi}{3}$$

$$\therefore 2x = \frac{4\pi}{3} \text{ or } \frac{\pi}{3} \text{ or } -\frac{2\pi}{3} \text{ or } -\frac{5\pi}{3}$$

$$\therefore x = \frac{2\pi}{3} \text{ or } \frac{\pi}{6} \text{ or } -\frac{\pi}{3} \text{ or } -\frac{5\pi}{6}$$

Exercise 1A

Skillsheet

1 a Convert the following angles from degrees to exact values in radians:

i 720° **ii** 540° **iii** -450° **iv** 15° **v** -10° **vi** -315°

Example 1

b Convert the following angles from radians to degrees:

i $\frac{5\pi}{4}$ **ii** $-\frac{2\pi}{3}$ **iii** $\frac{7\pi}{12}$ **iv** $-\frac{11\pi}{6}$ **v** $\frac{13\pi}{9}$ **vi** $-\frac{11\pi}{12}$

2 Perform the correct conversion on each of the following angles, giving the answer correct to two decimal places.

a Convert from degrees to radians:

- i** 7° **ii** -100° **iii** -25° **iv** 51° **v** 206° **vi** -410°

b Convert from radians to degrees:

- i** 1.7^c **ii** -0.87^c **iii** 2.8^c **iv** 0.1^c **v** -3^c **vi** -8.9^c

Example 2 **3** Find the exact value of each of the following:

- a** $\sin(135^\circ)$ **b** $\cos(-300^\circ)$ **c** $\sin(480^\circ)$
d $\cos(240^\circ)$ **e** $\sin(-225^\circ)$ **f** $\sin(420^\circ)$

Example 3 **4** Find the exact value of each of the following:

- a** $\sin\left(\frac{2\pi}{3}\right)$ **b** $\cos\left(\frac{3\pi}{4}\right)$ **c** $\cos\left(-\frac{\pi}{3}\right)$
d $\cos\left(\frac{5\pi}{4}\right)$ **e** $\cos\left(\frac{9\pi}{4}\right)$ **f** $\sin\left(\frac{11\pi}{3}\right)$
g $\cos\left(\frac{31\pi}{6}\right)$ **h** $\cos\left(\frac{29\pi}{6}\right)$ **i** $\sin\left(-\frac{23\pi}{6}\right)$

Example 4 **5** If $\sin(x^\circ) = 0.5$ and $90 < x < 180$, find:

- a** $\cos(x^\circ)$ **b** $\tan(x^\circ)$

6 If $\cos(x^\circ) = -0.7$ and $180 < x < 270$, find:

- a** $\sin(x^\circ)$ **b** $\tan(x^\circ)$

7 If $\sin x = -0.5$ and $\pi < x < \frac{3\pi}{2}$, find:

- a** $\cos x$ **b** $\tan x$

8 If $\sin x = -0.3$ and $\frac{3\pi}{2} < x < 2\pi$, find:

- a** $\cos x$ **b** $\tan x$

Example 5 **9** The graph of $y = f(x)$ for $f: [0, 2\pi] \rightarrow \mathbb{R}$, $f(x) = \cos x$ is shown.

For each pronumerals marked on the x -axis, find the other x -value which has the same y -value.

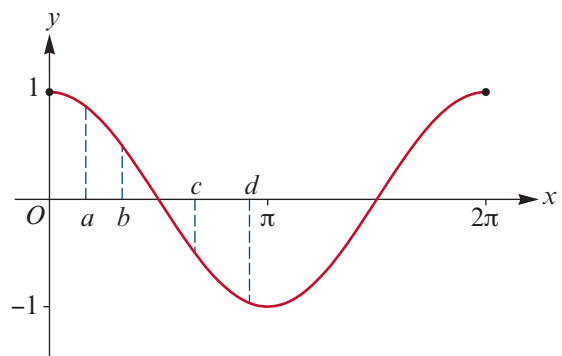

Example 6 10 Solve each of the following for $x \in [0, 2\pi]$:

a $\sin x = -\frac{\sqrt{3}}{2}$

b $\sin(2x) = -\frac{\sqrt{3}}{2}$

c $2 \cos(2x) = -1$

d $\sin\left(x + \frac{\pi}{3}\right) = -\frac{1}{2}$

e $2 \cos\left(2\left(x + \frac{\pi}{3}\right)\right) = -1$

f $2 \sin\left(2x + \frac{\pi}{3}\right) = -\sqrt{3}$

Example 7 11 Sketch the graph of each of the following for the stated domain:

a $f(x) = \sin(2x)$, $x \in [0, 2\pi]$

b $f(x) = \cos\left(x + \frac{\pi}{3}\right)$, $x \in \left[-\frac{\pi}{3}, \pi\right]$

c $f(x) = \cos\left(2\left(x + \frac{\pi}{3}\right)\right)$, $x \in [0, \pi]$

d $f(x) = 2 \sin(3x) + 1$, $x \in [0, \pi]$

e $f(x) = 2 \sin\left(x - \frac{\pi}{4}\right) + \sqrt{3}$, $x \in [0, 2\pi]$

Example 8 12 Find the exact value of each of the following:

a $\tan\left(\frac{5\pi}{4}\right)$

b $\tan\left(-\frac{2\pi}{3}\right)$

c $\tan\left(-\frac{29\pi}{6}\right)$

d $\tan 240^\circ$

13 If $\tan x = \frac{1}{4}$ and $\pi \leq x \leq \frac{3\pi}{2}$, find the exact value of:

a $\sin x$

b $\cos x$

c $\tan(-x)$

d $\tan(\pi - x)$

14 If $\tan x = -\frac{\sqrt{3}}{2}$ and $\frac{\pi}{2} \leq x \leq \pi$, find the exact value of:

a $\sin x$

b $\cos x$

c $\tan(-x)$

d $\tan(x - \pi)$

Example 9 15 Solve each of the following for $x \in [0, 2\pi]$:

a $\tan x = -\sqrt{3}$

b $\tan\left(3x - \frac{\pi}{6}\right) = \frac{\sqrt{3}}{3}$

c $2 \tan\left(\frac{x}{2}\right) + 2 = 0$

d $3 \tan\left(\frac{\pi}{2} + 2x\right) = -3$

16 Sketch the graph of each of the following for $x \in [0, \pi]$, clearly labelling all intercepts with the axes and all asymptotes:

a $f(x) = \tan(2x)$

b $f(x) = \tan\left(x - \frac{\pi}{3}\right)$

c $f(x) = 2 \tan\left(2x + \frac{\pi}{3}\right)$

d $f(x) = 2 \tan\left(2x + \frac{\pi}{3}\right) - 2$



1B The sine and cosine rules

In this section, we revise methods for finding unknown quantities (side lengths or angles) in a non-right-angled triangle.

Labelling triangles

The following convention is used in the remainder of this chapter:

- Interior angles are denoted by uppercase letters.
- The length of the side opposite an angle is denoted by the corresponding lowercase letter.

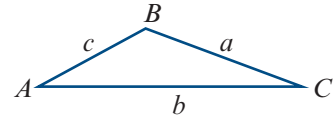

For example, the magnitude of angle BAC is denoted by A , and the length of side BC is denoted by a .

► The sine rule

The sine rule is used to find unknown quantities in a triangle in the following two situations:

- 1 one side and two angles are given
- 2 two sides and a non-included angle are given.

In the first case, the triangle is uniquely defined up to congruence. In the second case, there may be two triangles.

Sine rule

For triangle ABC :

$$\frac{a}{\sin A} = \frac{b}{\sin B} = \frac{c}{\sin C}$$

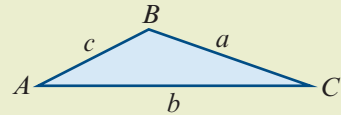

Proof We will give a proof for acute-angled triangles. The proof for obtuse-angled triangles is similar.

In triangle ACD :

$$\sin A = \frac{h}{b}$$

$$\therefore h = b \sin A$$

In triangle BCD :

$$\sin B = \frac{h}{a}$$

$$\therefore a \sin B = b \sin A$$

$$\text{i.e. } \frac{a}{\sin A} = \frac{b}{\sin B}$$

Similarly, starting with a perpendicular from A to BC would give

$$\frac{b}{\sin B} = \frac{c}{\sin C}$$

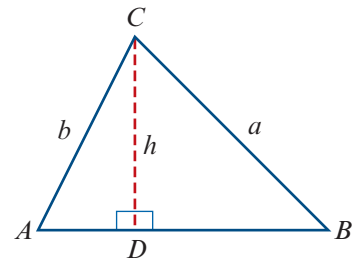

Example 10

Use the sine rule to find the length of AB .

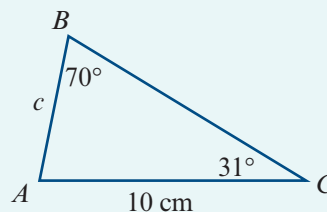
**Solution**

$$\frac{c}{\sin 31^\circ} = \frac{10}{\sin 70^\circ}$$

$$\therefore c = \frac{10 \sin 31^\circ}{\sin 70^\circ}$$

$$= 5.4809 \dots$$

The length of AB is 5.48 cm, correct to two decimal places.

Example 11

Use the sine rule to find the magnitude of angle XZY , given that $Y = 25^\circ$, $y = 5$ and $z = 6$.

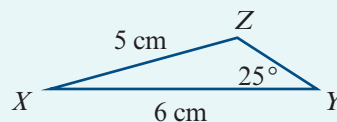
**Solution**

$$\frac{5}{\sin 25^\circ} = \frac{6}{\sin Z}$$

$$\frac{\sin Z}{6} = \frac{\sin 25^\circ}{5}$$

$$\sin Z = \frac{6 \sin 25^\circ}{5}$$

$$= 0.5071 \dots$$

$$\therefore Z = (30.473 \dots)^\circ \quad \text{or} \quad Z = (180 - 30.473 \dots)^\circ$$

Hence $Z = 30.47^\circ$ or $Z = 149.53^\circ$, correct to two decimal places.

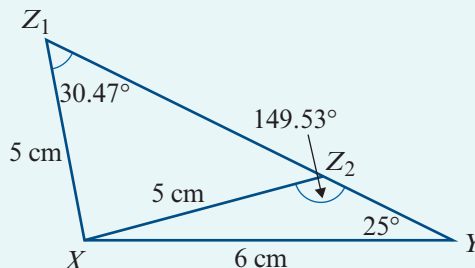
**Notes:**

- Remember that $\sin(180 - \theta) = \sin(\theta)$.
- When you are given two sides and a non-included angle, you must consider the possibility that there are two such triangles. An angle found using the sine rule is possible if the sum of the given angle and the found angle is less than 180° .

► The cosine rule

The cosine rule can be used to find unknown quantities in a triangle in the following two situations:

- 1 two sides and the included angle are given
- 2 three sides are given.

In each case, the triangle is uniquely defined up to congruence.

Cosine rule

For triangle ABC :

$$a^2 = b^2 + c^2 - 2bc \cos A$$

or equivalently

$$\cos A = \frac{b^2 + c^2 - a^2}{2bc}$$

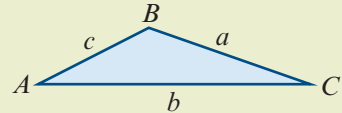

The symmetrical results also hold:

- $b^2 = a^2 + c^2 - 2ac \cos B$
- $c^2 = a^2 + b^2 - 2ab \cos C$

Proof We will give a proof for acute-angled triangles. The proof for obtuse-angled triangles is similar.

In triangle ACD :

$$\cos A = \frac{x}{b}$$

$$\therefore x = b \cos A$$

Using Pythagoras' theorem in triangles ACD and BCD :

$$b^2 = x^2 + h^2$$

$$a^2 = (c - x)^2 + h^2$$

Expanding gives

$$a^2 = c^2 - 2cx + x^2 + h^2$$

$$= c^2 - 2cx + b^2 \quad (\text{as } b^2 = x^2 + h^2)$$

$$\therefore a^2 = b^2 + c^2 - 2bc \cos A \quad (\text{as } x = b \cos A)$$

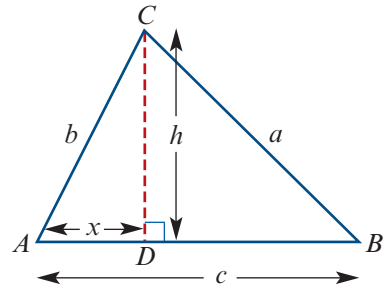

Example 12

For triangle ABC , find the length of AB in centimetres correct to two decimal places.

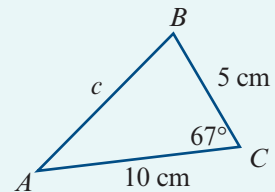

Solution

$$\begin{aligned}c^2 &= 5^2 + 10^2 - 2 \times 5 \times 10 \cos 67^\circ \\ &= 85.9268\dots \\ \therefore c &= 9.2696\dots\end{aligned}$$

The length of AB is 9.27 cm, correct to two decimal places.

Example 13

For triangle ABC , find the magnitude of angle ABC correct to two decimal places.

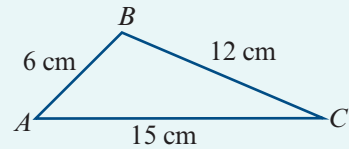
**Solution**

$$\begin{aligned}\cos B &= \frac{a^2 + c^2 - b^2}{2ac} \\ &= \frac{12^2 + 6^2 - 15^2}{2 \times 12 \times 6} \\ &= -0.3125 \\ \therefore B &= (108.2099\dots)^\circ\end{aligned}$$

The magnitude of angle ABC is 108.21° , correct to two decimal places.

Example 14

In $\triangle ABC$, $\angle CAB = 82^\circ$, $AC = 12$ cm and $AB = 15$ cm.

Find correct to two decimal places:

- a** BC
b $\angle ACB$

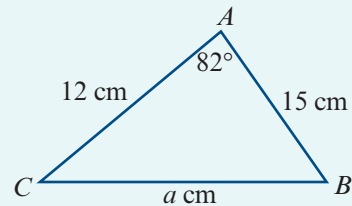
**Solution**

- a** Find BC using the cosine rule:

$$\begin{aligned}a^2 &= b^2 + c^2 - 2bc \cos A \\ &= 12^2 + 15^2 - 2 \times 12 \times 15 \cos 82^\circ \\ &= 144 + 225 - 360 \cos 82^\circ \\ &= 318.8976\dots \\ a &= 17.8577\dots\end{aligned}$$

Thus $BC = a = 17.86$ cm, correct to two decimal places.

- b** Find $\angle ACB$ using the sine rule:

$$\begin{aligned}\frac{a}{\sin A} &= \frac{c}{\sin C} \\ \therefore \sin C &= \frac{c \sin A}{a} \\ &= \frac{15 \sin 82^\circ}{17.8577}\end{aligned}$$

Thus $\angle ACB = 56.28^\circ$, correct to two decimal places.

Note: In part **b**, the angle $C = 123.72^\circ$ is also a solution to the equation, but it is discarded as a possible answer because it is inconsistent with the given angle $A = 82^\circ$.

Exercise 1B

Skillsheet

Example 10

- 1 In triangle ABC , $\angle BAC = 73^\circ$, $\angle ACB = 55^\circ$ and $AB = 10$ cm. Find correct to two decimal places:
- a** BC **b** AC

Example 11

- 2 In $\triangle ABC$, $\angle ACB = 34^\circ$, $AC = 8.5$ cm and $AB = 5.6$ cm. Find correct to two decimal places:
- a** the two possible values of $\angle ABC$ (one acute and one obtuse)
b BC in each case.

Example 12

- 3 In triangle ABC , $\angle ABC = 58^\circ$, $AB = 6.5$ cm and $BC = 8$ cm. Find correct to two decimal places:
- a** AC **b** $\angle BCA$

Example 13, 14

- 4 In $\triangle ABC$, $AB = 5$ cm, $BC = 12$ cm and $AC = 10$ cm. Find:
- a** the magnitude of $\angle ABC$, correct to two decimal places
b the magnitude of $\angle BAC$, correct to two decimal places.

- 5 The adjacent sides of a parallelogram are 9 cm and 11 cm. One of its angles is 67° . Find the length of the longer diagonal, correct to two decimal places.

Example 14

- 6 In $\triangle ABC$, $\angle ABC = 35^\circ$, $AB = 10$ cm and $BC = 4.7$ cm. Find correct to two decimal places:
- a** AC **b** $\angle ACB$

- 7 In $\triangle ABC$, $\angle ABC = 45^\circ$, $\angle ACB = 60^\circ$ and $AC = 12$ cm. Find AB .

- 8 In $\triangle PQR$, $\angle QPR = 60^\circ$, $PQ = 2$ cm and $PR = 3$ cm. Find QR .

- 9 In $\triangle ABC$, the angle ABC has magnitude 40° , $AC = 20$ cm and $AB = 18$ cm. Find the distance BC correct to two decimal places.



- 10 In $\triangle ABC$, the angle ACB has magnitude 30° , $AC = 10$ cm and $AB = 8$ cm. Find the distance BC using the cosine rule.

1C Circles



Consider a circle with centre at the origin and radius r .

If a point with coordinates (x, y) lies on the circle, then Pythagoras' theorem gives

$$x^2 + y^2 = r^2$$

The converse is also true. That is, a point with coordinates (x, y) such that $x^2 + y^2 = r^2$ lies on the circle.

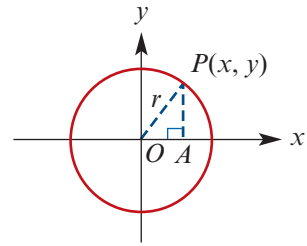

Cartesian equation of a circle

The circle with centre (h, k) and radius r is the graph of the equation

$$(x - h)^2 + (y - k)^2 = r^2$$

Note: This circle is obtained from the circle with equation $x^2 + y^2 = r^2$ by the translation defined by $(x, y) \rightarrow (x + h, y + k)$.

Example 15

Sketch the graph of the circle with centre $(-2, 5)$ and radius 2, and state the Cartesian equation for this circle.

Solution

The equation is

$$(x + 2)^2 + (y - 5)^2 = 4$$

which may also be written as

$$x^2 + y^2 + 4x - 10y + 25 = 0$$

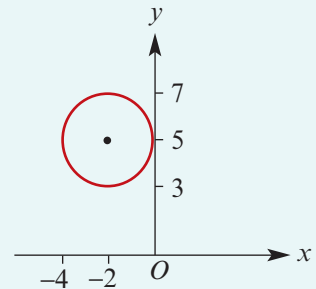

The equation $x^2 + y^2 + 4x - 10y + 25 = 0$ can be 'unsimplified' by completing the square:

$$x^2 + y^2 + 4x - 10y + 25 = 0$$

$$x^2 + 4x + 4 + y^2 - 10y + 25 + 25 = 29$$

$$(x + 2)^2 + (y - 5)^2 = 4$$

This suggests a general form of the equation of a circle:

$$x^2 + y^2 + Dx + Ey + F = 0$$

Completing the square gives

$$x^2 + Dx + \frac{D^2}{4} + y^2 + Ey + \frac{E^2}{4} + F = \frac{D^2 + E^2}{4}$$

i.e.
$$\left(x + \frac{D}{2}\right)^2 + \left(y + \frac{E}{2}\right)^2 = \frac{D^2 + E^2 - 4F}{4}$$

- If $D^2 + E^2 - 4F > 0$, then this equation represents a circle.
- If $D^2 + E^2 - 4F = 0$, then this equation represents one point $\left(-\frac{D}{2}, -\frac{E}{2}\right)$.
- If $D^2 + E^2 - 4F < 0$, then this equation has no representation in the Cartesian plane.

Example 16

Sketch the graph of $x^2 + y^2 + 4x + 6y - 12 = 0$. State the coordinates of the centre and the radius.

Solution

Complete the square in both x and y :

$$\begin{aligned}x^2 + y^2 + 4x + 6y - 12 &= 0 \\x^2 + 4x + 4 + y^2 + 6y + 9 - 12 &= 13 \\(x + 2)^2 + (y + 3)^2 &= 25\end{aligned}$$

The circle has centre $(-2, -3)$ and radius 5.

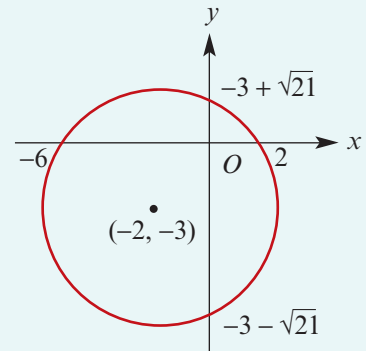
**Example 17**

Sketch a graph of the region of the plane such that $x^2 + y^2 < 9$ and $x \geq 1$.

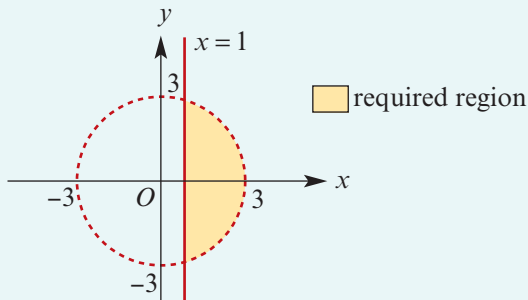
Solution**Exercise 1C****Example 15**

- 1 For each of the following, find the equation of the circle with the given centre and radius:
- | | |
|--------------------------------------|--|
| a centre $(2, 3)$; radius 1 | b centre $(-3, 4)$; radius 5 |
| c centre $(0, -5)$; radius 5 | d centre $(3, 0)$; radius $\sqrt{2}$ |

Example 16

- 2 Find the radius and the coordinates of the centre of the circle with equation:
- | | |
|---|--|
| a $x^2 + y^2 + 4x - 6y + 12 = 0$ | b $x^2 + y^2 - 2x - 4y + 1 = 0$ |
| c $x^2 + y^2 - 3x = 0$ | d $x^2 + y^2 + 4x - 10y + 25 = 0$ |

3 Sketch the graph of each of the following:

a $2x^2 + 2y^2 + x + y = 0$

b $x^2 + y^2 + 3x - 4y = 6$

c $x^2 + y^2 + 8x - 10y + 16 = 0$

d $x^2 + y^2 - 8x - 10y + 16 = 0$

e $2x^2 + 2y^2 - 8x + 5y + 10 = 0$

f $3x^2 + 3y^2 + 6x - 9y = 100$

Example 17

4 For each of the following, sketch the graph of the specified region of the plane:

a $x^2 + y^2 \leq 16$

b $x^2 + y^2 \geq 9$

c $(x - 2)^2 + (y - 2)^2 < 4$

d $(x - 3)^2 + (y + 2)^2 > 16$

e $x^2 + y^2 \leq 16$ and $x \leq 2$

f $x^2 + y^2 \leq 9$ and $y \geq -1$

5 The points (8, 4) and (2, 2) are the ends of a diameter of a circle. Find the coordinates of the centre and the radius of the circle.

6 Find the equation of the circle with centre (2, -3) that touches the x -axis.

7 Find the equation of the circle that passes through (3, 1), (8, 2) and (2, 6).

8 Consider the circles with equations

$$4x^2 + 4y^2 - 60x - 76y + 536 = 0 \quad \text{and} \quad x^2 + y^2 - 10x - 14y + 49 = 0$$

a Find the radius and the coordinates of the centre of each circle.

b Find the coordinates of the points of intersection of the two circles.

9 Find the coordinates of the points of intersection of the circle with equation $x^2 + y^2 = 25$ and the line with equation:

a $y = x$

b $y = 2x$



1D Ellipses and hyperbolas

Ellipses and hyperbolas will arise in our study of vector calculus in Chapter 16. In this section, we sketch the graphs of these curves from their Cartesian equations.

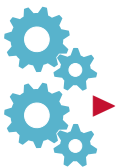

▶ Ellipses

For positive constants a and b , the curve with equation

$$\frac{x^2}{a^2} + \frac{y^2}{b^2} = 1$$

is obtained from the unit circle $x^2 + y^2 = 1$ by applying the following dilations:

- a dilation of factor a from the y -axis, i.e. $(x, y) \rightarrow (ax, y)$
- a dilation of factor b from the x -axis, i.e. $(x, y) \rightarrow (x, by)$.

The result is the transformation $(x, y) \rightarrow (ax, by)$.

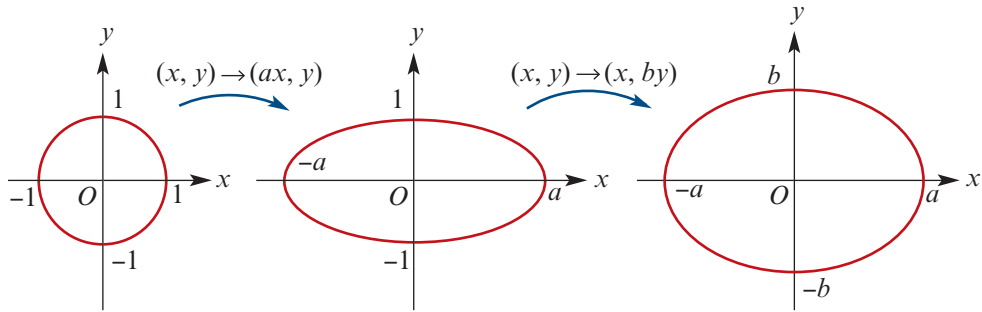

The curve with equation

$$\frac{x^2}{a^2} + \frac{y^2}{b^2} = 1$$

is an ellipse centred at the origin with x -axis intercepts at $(-a, 0)$ and $(a, 0)$ and with y -axis intercepts at $(0, -b)$ and $(0, b)$.

If $a = b$, then the ellipse is a circle centred at the origin with radius a .

Ellipse $\frac{x^2}{a^2} + \frac{y^2}{b^2} = 1$ where $a > b$

Ellipse $\frac{x^2}{a^2} + \frac{y^2}{b^2} = 1$ where $b > a$

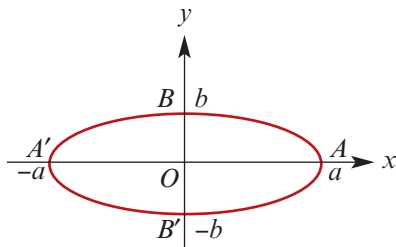

AA' is the major axis

BB' is the minor axis

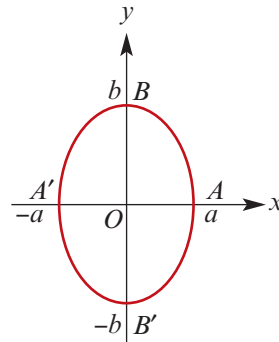

AA' is the minor axis

BB' is the major axis

Cartesian equation of an ellipse

The graph of the equation

$$\frac{(x-h)^2}{a^2} + \frac{(y-k)^2}{b^2} = 1$$

is an ellipse with centre (h, k) . It is obtained from the ellipse

$$\frac{x^2}{a^2} + \frac{y^2}{b^2} = 1$$

by the translation $(x, y) \rightarrow (x + h, y + k)$.

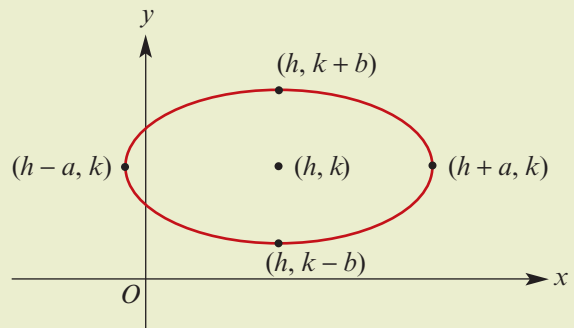

Example 18

Sketch the graph of each of the following ellipses. Give the coordinates of the centre and the axis intercepts.

a $\frac{x^2}{9} + \frac{y^2}{4} = 1$

b $\frac{x^2}{4} + \frac{y^2}{9} = 1$

c $\frac{(x-2)^2}{9} + \frac{(y-3)^2}{16} = 1$

d $3x^2 + 24x + y^2 + 36 = 0$

Solution

a Centre (0, 0)

Axis intercepts $(\pm 3, 0)$ and $(0, \pm 2)$

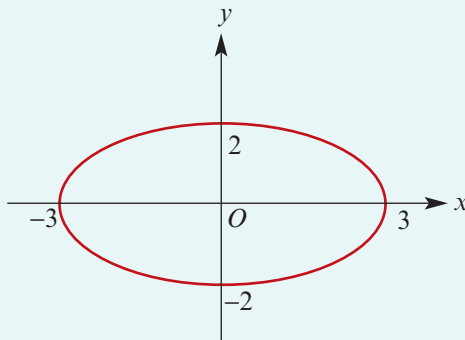

b Centre (0, 0)

Axis intercepts $(\pm 2, 0)$ and $(0, \pm 3)$

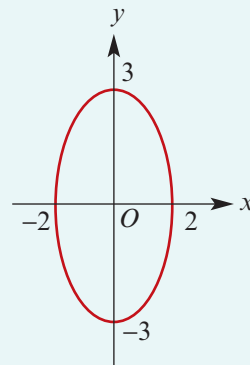

c Centre (2, 3)

y-axis intercepts

When $x = 0$: $\frac{4}{9} + \frac{(y-3)^2}{16} = 1$

$$\frac{(y-3)^2}{16} = \frac{5}{9}$$

$$(y-3)^2 = \frac{16 \times 5}{9}$$

$$\therefore y = 3 \pm \frac{4\sqrt{5}}{3}$$

x-axis intercepts

When $y = 0$: $\frac{(x-2)^2}{9} + \frac{9}{16} = 1$

$$\frac{(x-2)^2}{9} = \frac{7}{16}$$

$$(x-2)^2 = \frac{9 \times 7}{16}$$

$$\therefore x = 2 \pm \frac{3\sqrt{7}}{4}$$

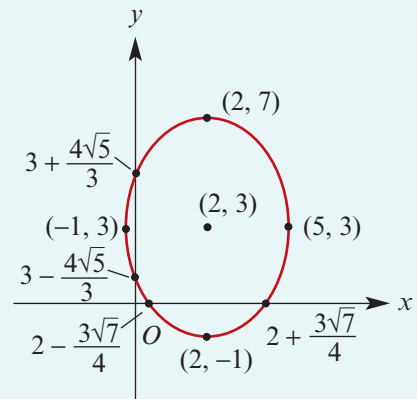

d Completing the square:

$$3x^2 + 24x + y^2 + 36 = 0$$

$$3(x^2 + 8x + 16) + y^2 + 36 - 48 = 0$$

$$3(x + 4)^2 + y^2 = 12$$

i.e.
$$\frac{(x + 4)^2}{4} + \frac{y^2}{12} = 1$$

Centre $(-4, 0)$

Axis intercepts $(-6, 0)$ and $(-2, 0)$

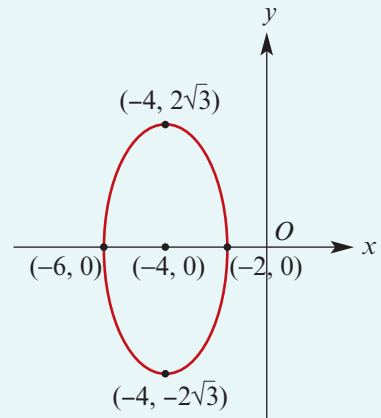

Given an equation of the form

$$Ax^2 + By^2 + Cx + Ey + F = 0$$

where both A and B are positive, the corresponding graph is an ellipse or a point. If $A = B$, then the graph is a circle. In some cases, as for the circle, no pairs (x, y) will satisfy the equation.

► Hyperbolas

The curve with equation

$$\frac{x^2}{a^2} - \frac{y^2}{b^2} = 1$$

is a hyperbola centred at the origin with axis intercepts $(a, 0)$ and $(-a, 0)$.

The hyperbola has asymptotes $y = \frac{b}{a}x$ and $y = -\frac{b}{a}x$.

To see why this should be the case, we rearrange the equation of the hyperbola as follows:

$$\frac{x^2}{a^2} - \frac{y^2}{b^2} = 1$$

$$\frac{y^2}{b^2} = \frac{x^2}{a^2} - 1$$

$$\therefore y^2 = \frac{b^2 x^2}{a^2} \left(1 - \frac{a^2}{x^2}\right)$$

As $x \rightarrow \pm\infty$, we have $\frac{a^2}{x^2} \rightarrow 0$ and therefore

$$y^2 \rightarrow \frac{b^2 x^2}{a^2}$$

i.e.
$$y \rightarrow \pm \frac{bx}{a}$$

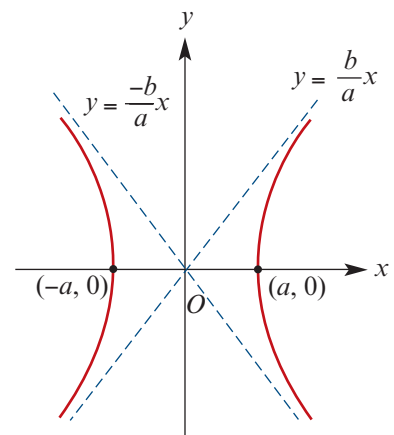

Cartesian equation of a hyperbola

The graph of the equation

$$\frac{(x-h)^2}{a^2} - \frac{(y-k)^2}{b^2} = 1$$

is a hyperbola with centre (h, k) . The asymptotes are

$$y - k = \pm \frac{b}{a}(x - h)$$

Note: This hyperbola is obtained from the hyperbola with equation $\frac{x^2}{a^2} - \frac{y^2}{b^2} = 1$ by the translation defined by $(x, y) \rightarrow (x + h, y + k)$.

**Example 19**

For each of the following equations, sketch the graph of the corresponding hyperbola. Give the coordinates of the centre, the axis intercepts and the equations of the asymptotes.

a $\frac{x^2}{9} - \frac{y^2}{4} = 1$

b $\frac{y^2}{9} - \frac{x^2}{4} = 1$

c $(x-1)^2 - (y+2)^2 = 1$

d $\frac{(y-1)^2}{4} - \frac{(x+2)^2}{9} = 1$

Solution

a Since $\frac{x^2}{9} - \frac{y^2}{4} = 1$, we have

$$y^2 = \frac{4x^2}{9} \left(1 - \frac{9}{x^2}\right)$$

Thus the equations of the asymptotes are $y = \pm \frac{2}{3}x$.

If $y = 0$, then $x^2 = 9$ and so $x = \pm 3$. The x -axis intercepts are $(3, 0)$ and $(-3, 0)$. The centre is $(0, 0)$.

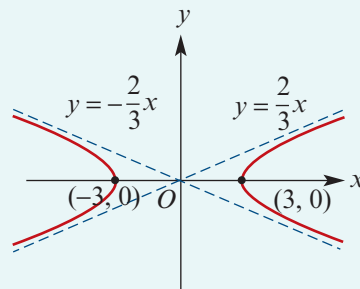

b Since $\frac{y^2}{9} - \frac{x^2}{4} = 1$, we have

$$y^2 = \frac{9x^2}{4} \left(1 + \frac{4}{x^2}\right)$$

Thus the equations of the asymptotes are $y = \pm \frac{3}{2}x$.

The y -axis intercepts are $(0, 3)$ and $(0, -3)$.

The centre is $(0, 0)$.

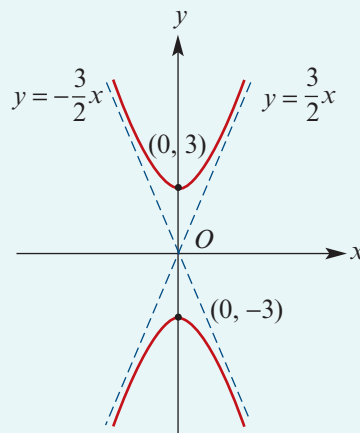

- c** First sketch the graph of $x^2 - y^2 = 1$. The asymptotes are $y = x$ and $y = -x$. The centre is $(0, 0)$ and the axis intercepts are $(1, 0)$ and $(-1, 0)$.

Note: This is called a **rectangular hyperbola**, as its asymptotes are perpendicular.

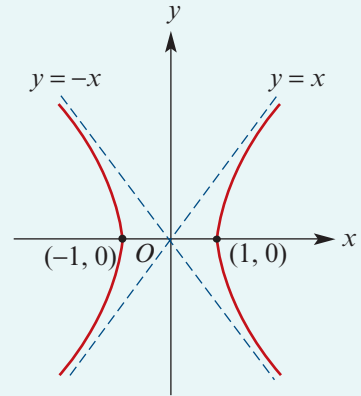

Now to sketch the graph of

$$(x - 1)^2 - (y + 2)^2 = 1$$

we apply the translation $(x, y) \rightarrow (x + 1, y - 2)$.

The new centre is $(1, -2)$ and the asymptotes have equations $y + 2 = \pm(x - 1)$. That is, $y = x - 3$ and $y = -x - 1$.

Axis intercepts

If $x = 0$, then $y = -2$.

If $y = 0$, then $(x - 1)^2 = 5$ and so $x = 1 \pm \sqrt{5}$.

Therefore the axis intercepts are $(0, -2)$ and $(1 \pm \sqrt{5}, 0)$.

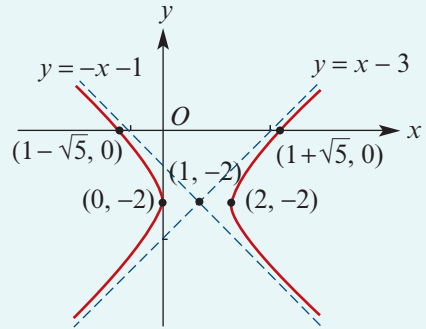

- d** The graph of $\frac{(y - 1)^2}{4} - \frac{(x + 2)^2}{9} = 1$ is obtained from the hyperbola $\frac{y^2}{4} - \frac{x^2}{9} = 1$ through the translation $(x, y) \rightarrow (x - 2, y + 1)$. Its centre will be $(-2, 1)$.

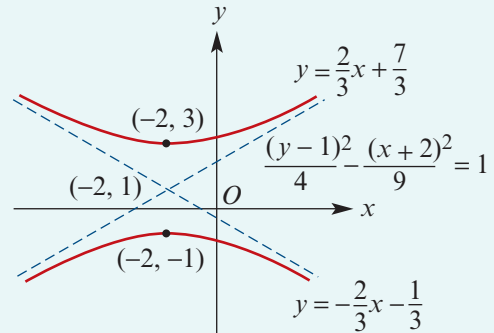
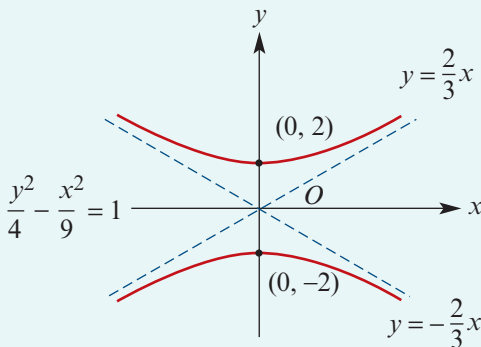

The axis intercepts are $(0, 1 \pm \frac{2\sqrt{13}}{3})$.

Note: The hyperbolas $\frac{y^2}{4} - \frac{x^2}{9} = 1$ and $\frac{x^2}{9} - \frac{y^2}{4} = 1$ have the same asymptotes; they are called **conjugate hyperbolas**.

Exercise 1D

Skillsheet

- 1** Sketch the graph of each of the following. Label the axis intercepts and state the coordinates of the centre.

Example 18

a $\frac{x^2}{9} + \frac{y^2}{16} = 1$

b $25x^2 + 16y^2 = 400$

c $\frac{(x-4)^2}{9} + \frac{(y-1)^2}{16} = 1$

d $x^2 + \frac{(y-2)^2}{9} = 1$

e $9x^2 + 25y^2 - 54x - 100y = 44$

f $9x^2 + 25y^2 = 225$

g $5x^2 + 9y^2 + 20x - 18y - 16 = 0$

h $16x^2 + 25y^2 - 32x + 100y - 284 = 0$

i $\frac{(x-2)^2}{4} + \frac{(y-3)^2}{9} = 1$

j $2(x-2)^2 + 4(y-1)^2 = 16$

Example 19

- 2** Sketch the graph of each of the following. Label the axis intercepts and give the equations of the asymptotes.

a $\frac{x^2}{16} - \frac{y^2}{9} = 1$

b $\frac{y^2}{16} - \frac{x^2}{9} = 1$

c $x^2 - y^2 = 4$

d $2x^2 - y^2 = 4$

e $x^2 - 4y^2 - 4x - 8y - 16 = 0$

f $9x^2 - 25y^2 - 90x + 150y = 225$

g $\frac{(x-2)^2}{4} - \frac{(y-3)^2}{9} = 1$

h $4x^2 - 8x - y^2 + 2y = 0$

i $9x^2 - 16y^2 - 18x + 32y - 151 = 0$

j $25x^2 - 16y^2 = 400$

- 3** Find the coordinates of the points of intersection of $y = \frac{1}{2}x$ with:

a $x^2 - y^2 = 1$

b $\frac{x^2}{4} + y^2 = 1$

- 4** Show that there is no intersection point of the line $y = x + 5$ with the ellipse $x^2 + \frac{y^2}{4} = 1$.

- 5** Find the points of intersection of the curves $\frac{x^2}{4} + \frac{y^2}{9} = 1$ and $\frac{x^2}{9} + \frac{y^2}{4} = 1$. Show that the points of intersection are the vertices of a square.

- 6** Find the coordinates of the points of intersection of $\frac{x^2}{16} + \frac{y^2}{25} = 1$ and the line with equation $5x = 4y$.



- 7** On the one set of axes, sketch the graphs of $x^2 + y^2 = 9$ and $x^2 - y^2 = 9$.

1E Parametric equations

In Chapter 16, we will study motion along a curve. A **parameter** (usually t representing time) will be used to help describe these curves. In this section, we give an introduction to parametric equations of curves in the plane.

► The unit circle

The unit circle can be expressed in Cartesian form as $\{(x, y) : x^2 + y^2 = 1\}$. We have seen in Section 1A that the unit circle can also be expressed as

$$\{(x, y) : x = \cos t \text{ and } y = \sin t, \text{ for some } t \in \mathbb{R}\}$$

The set notation is often omitted, and we can describe the unit circle by the equations

$$x = \cos t \quad \text{and} \quad y = \sin t \quad \text{for } t \in \mathbb{R}$$

These are the **parametric equations** for the unit circle.

We still obtain the entire unit circle if we restrict the values of t to the interval $[0, 2\pi]$.

The following three diagrams illustrate the graphs obtained from the parametric equations $x = \cos t$ and $y = \sin t$ for three different sets of values of t .

$$t \in [0, 2\pi]$$

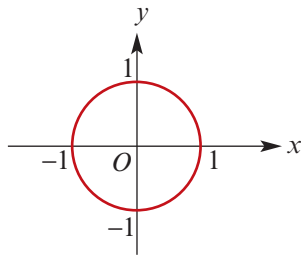

$$t \in [0, \pi]$$

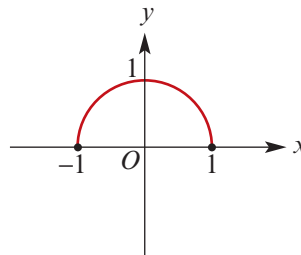

$$t \in \left[0, \frac{\pi}{2}\right]$$

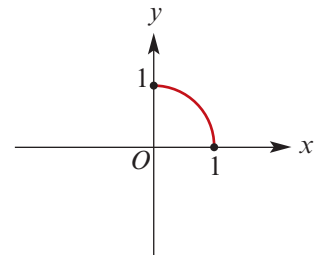

► Circles

Parametric equations for a circle centred at the origin

The circle with centre the origin and radius a is described by the parametric equations

$$x = a \cos t \quad \text{and} \quad y = a \sin t$$

The entire circle is obtained by taking $t \in [0, 2\pi]$.

Note: To obtain the Cartesian equation, first rearrange the parametric equations as

$$\frac{x}{a} = \cos t \quad \text{and} \quad \frac{y}{a} = \sin t$$

Square and add these equations to obtain

$$\frac{x^2}{a^2} + \frac{y^2}{a^2} = \cos^2 t + \sin^2 t = 1$$

This equation can be written as $x^2 + y^2 = a^2$, which is the Cartesian equation of the circle with centre the origin and radius a .

The domain and range of the circle can be found from the parametric equations:

- **Domain** The range of the function with rule $x = a \cos t$ is $[-a, a]$.
Hence the domain of the relation $x^2 + y^2 = a^2$ is $[-a, a]$.
- **Range** The range of the function with rule $y = a \sin t$ is $[-a, a]$.
Hence the range of the relation $x^2 + y^2 = a^2$ is $[-a, a]$.



Example 20

A circle is defined by the parametric equations

$$x = 2 + 3 \cos \theta \quad \text{and} \quad y = 1 + 3 \sin \theta \quad \text{for } \theta \in [0, 2\pi]$$

Find the Cartesian equation of the circle, and state the domain and range of this relation.

Solution

Domain

The range of the function with rule $x = 2 + 3 \cos \theta$ is $[-1, 5]$. Hence the domain of the corresponding Cartesian relation is $[-1, 5]$.

Range

The range of the function with rule $y = 1 + 3 \sin \theta$ is $[-2, 4]$. Hence the range of the corresponding Cartesian relation is $[-2, 4]$.

Cartesian equation

Rewrite the parametric equations as

$$\frac{x-2}{3} = \cos \theta \quad \text{and} \quad \frac{y-1}{3} = \sin \theta$$

Square both sides of each of these equations and add:

$$\frac{(x-2)^2}{9} + \frac{(y-1)^2}{9} = \cos^2 \theta + \sin^2 \theta = 1$$

i.e. $(x-2)^2 + (y-1)^2 = 9$

Parametric equations for a circle

The circle with centre (h, k) and radius a is described by the parametric equations

$$x = h + a \cos t \quad \text{and} \quad y = k + a \sin t$$

The entire circle is obtained by taking $t \in [0, 2\pi]$.

► Parametric equations in general

A **parametric curve** in the plane is defined by a pair of functions

$$x = f(t) \quad \text{and} \quad y = g(t)$$

The variable t is called the **parameter**. Each value of t gives a point $(f(t), g(t))$ in the plane. The set of all such points will be a curve in the plane.

Note: If $x = f(t)$ and $y = g(t)$ are parametric equations for a curve C and you eliminate the parameter t between the two equations, then each point of the curve C lies on the curve represented by the resulting Cartesian equation.

Example 21

A curve is defined parametrically by the equations

$$x = at^2 \quad \text{and} \quad y = 2at \quad \text{for } t \in \mathbb{R}$$

where a is a positive constant. Find:

- the Cartesian equation of the curve
- the equation of the line passing through the points where $t = 1$ and $t = -2$
- the length of the chord joining the points where $t = 1$ and $t = -2$.

Solution

- a** The second equation gives $t = \frac{y}{2a}$.

Substitute this into the first equation:

$$\begin{aligned} x &= at^2 = a\left(\frac{y}{2a}\right)^2 \\ &= a\left(\frac{y^2}{4a^2}\right) \\ &= \frac{y^2}{4a} \end{aligned}$$

This can be written as $y^2 = 4ax$.

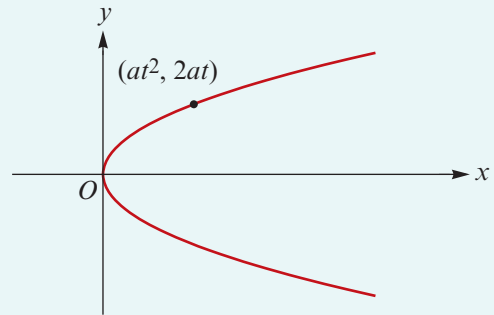

- b** At $t = 1$, $x = a$ and $y = 2a$. This is the point $(a, 2a)$.
At $t = -2$, $x = 4a$ and $y = -4a$. This is the point $(4a, -4a)$.

The gradient of the line is

$$m = \frac{2a - (-4a)}{a - 4a} = \frac{6a}{-3a} = -2$$

Therefore the equation of the line is

$$y - 2a = -2(x - a)$$

which simplifies to $y = -2x + 4a$.

- c** The chord joining $(a, 2a)$ and $(4a, -4a)$ has length

$$\begin{aligned} \sqrt{(a - 4a)^2 + (2a - (-4a))^2} &= \sqrt{9a^2 + 36a^2} \\ &= \sqrt{45a^2} \\ &= 3\sqrt{5}a \quad (\text{since } a > 0) \end{aligned}$$

► Ellipses

Parametric equations for an ellipse

The ellipse with the Cartesian equation $\frac{x^2}{a^2} + \frac{y^2}{b^2} = 1$ can be described by the parametric equations

$$x = a \cos t \quad \text{and} \quad y = b \sin t$$

The entire ellipse is obtained by taking $t \in [0, 2\pi]$.

Note: We can rearrange these parametric equations as

$$\frac{x}{a} = \cos t \quad \text{and} \quad \frac{y}{b} = \sin t$$

Square and add these equations to obtain

$$\frac{x^2}{a^2} + \frac{y^2}{b^2} = \cos^2 t + \sin^2 t = 1$$

The domain and range of the ellipse can be found from the parametric equations:

- **Domain** The range of the function with rule $x = a \cos t$ is $[-a, a]$.
Hence the domain of the relation $\frac{x^2}{a^2} + \frac{y^2}{b^2} = 1$ is $[-a, a]$.
- **Range** The range of the function with rule $y = b \sin t$ is $[-b, b]$.
Hence the range of the relation $\frac{x^2}{a^2} + \frac{y^2}{b^2} = 1$ is $[-b, b]$.

Example 22

Find the Cartesian equation of the curve with parametric equations

$$x = 3 + 3 \sin t \quad \text{and} \quad y = 2 - 2 \cos t \quad \text{for } t \in \mathbb{R}$$

and describe the graph.

Solution

We can rearrange the two equations as

$$\frac{x-3}{3} = \sin t \quad \text{and} \quad \frac{2-y}{2} = \cos t$$

Now square both sides of each equation and add:

$$\frac{(x-3)^2}{9} + \frac{(2-y)^2}{4} = \sin^2 t + \cos^2 t = 1$$

Since $(2-y)^2 = (y-2)^2$, this equation can be written more neatly as

$$\frac{(x-3)^2}{9} + \frac{(y-2)^2}{4} = 1$$

This is the equation of an ellipse with centre $(3, 2)$ and axis intercepts at $(3, 0)$ and $(0, 2)$.

► Hyperbolas

In order to give parametric equations for hyperbolas, we will be using the **secant function**, which is defined by

$$\sec \theta = \frac{1}{\cos \theta} \quad \text{if } \cos \theta \neq 0$$

The graphs of $y = \sec \theta$ and $y = \cos \theta$ are shown here on the same set of axes. The secant function is studied further in Chapter 3.

We will also use an alternative form of the Pythagorean identity

$$\cos^2 \theta + \sin^2 \theta = 1$$

Dividing both sides by $\cos^2 \theta$ gives

$$1 + \tan^2 \theta = \sec^2 \theta$$

We will use this identity in the form

$$\sec^2 \theta - \tan^2 \theta = 1$$

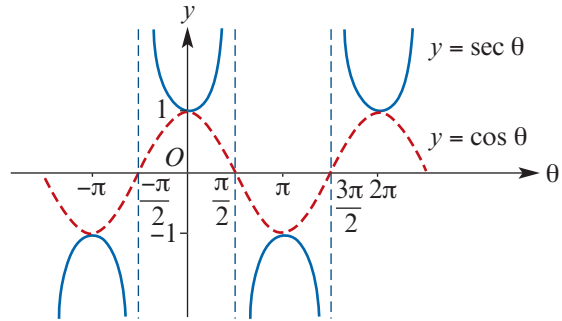

Parametric equations for a hyperbola

The hyperbola with the Cartesian equation $\frac{x^2}{a^2} - \frac{y^2}{b^2} = 1$ can be described by the parametric equations

$$x = a \sec t \quad \text{and} \quad y = b \tan t \quad \text{for } t \in \left(-\frac{\pi}{2}, \frac{\pi}{2}\right) \cup \left(\frac{\pi}{2}, \frac{3\pi}{2}\right)$$

Note: We can rearrange these parametric equations as

$$\frac{x}{a} = \sec t \quad \text{and} \quad \frac{y}{b} = \tan t$$

Square and subtract these equations to obtain

$$\frac{x^2}{a^2} - \frac{y^2}{b^2} = \sec^2 t - \tan^2 t = 1$$

The domain and range of the hyperbola can be determined from the parametric equations.

■ **Domain** There are two cases, giving the left and right branches of the hyperbola:

- For $t \in \left(-\frac{\pi}{2}, \frac{\pi}{2}\right)$, the range of the function with rule $x = a \sec t$ is $[a, \infty)$.

The domain $[a, \infty)$ gives the right branch of the hyperbola.

- For $t \in \left(\frac{\pi}{2}, \frac{3\pi}{2}\right)$, the range of the function with rule $x = a \sec t$ is $(-\infty, a]$.

The domain $(-\infty, a]$ gives the left branch of the hyperbola.

■ **Range** For both sections of the domain, the range of the function with rule $y = b \tan t$ is \mathbb{R} .



Example 23

Find the Cartesian equation of the curve with parametric equations

$$x = 3 \sec t \quad \text{and} \quad y = 4 \tan t \quad \text{for } t \in \left(\frac{\pi}{2}, \frac{3\pi}{2}\right)$$

Describe the curve.

Solution

Rearrange the two equations:

$$\frac{x}{3} = \sec t \quad \text{and} \quad \frac{y}{4} = \tan t$$

Square both sides of each equation and subtract:

$$\frac{x^2}{9} - \frac{y^2}{16} = \sec^2 t - \tan^2 t = 1$$

The Cartesian equation of the curve is $\frac{x^2}{9} - \frac{y^2}{16} = 1$.

The range of the function with rule $x = 3 \sec t$ for $t \in \left(\frac{\pi}{2}, \frac{3\pi}{2}\right)$ is $(-\infty, -3]$. Hence the domain for the graph is $(-\infty, -3]$.

The curve is the left branch of a hyperbola centred at the origin with x -axis intercept at $(-3, 0)$. The equations of the asymptotes are $y = \frac{4x}{3}$ and $y = -\frac{4x}{3}$.

► Finding parametric equations for a curve

When converting from a Cartesian equation to a pair of parametric equations, there are many different possible choices.

Example 24

Give parametric equations for each of the following:

a $x^2 + y^2 = 9$

b $\frac{x^2}{16} + \frac{y^2}{4} = 1$

c $\frac{(x-1)^2}{9} - \frac{(y+1)^2}{4} = 1$

Solution

a One possible solution is $x = 3 \cos t$ and $y = 3 \sin t$ for $t \in [0, 2\pi]$.



Another solution is $x = -3 \cos(2t)$ and $y = 3 \sin(2t)$ for $t \in [0, \pi]$.

Yet another solution is $x = 3 \sin t$ and $y = 3 \cos t$ for $t \in \mathbb{R}$.

b One solution is $x = 4 \cos t$ and $y = 2 \sin t$.

c One solution is $x - 1 = 3 \sec t$ and $y + 1 = 2 \tan t$.

Using the TI-Nspire

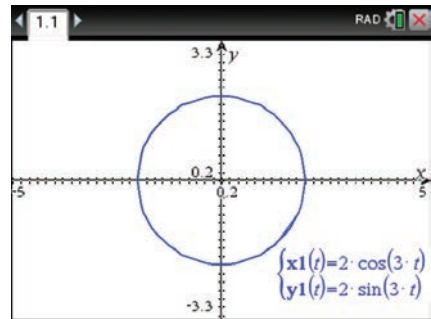
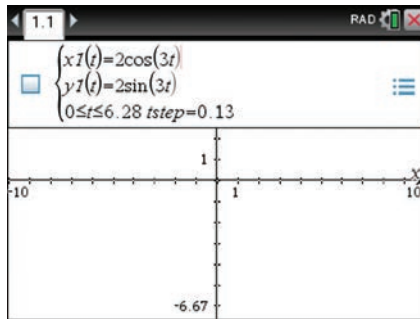

- Open a **Graphs** application ( on) > **New Document** > **Add Graphs**).
- Use  > **Graph Entry/Edit** > **Parametric** to show the entry line for parametric equations.
- Enter $x1(t) = 2 \cos(3t)$ and $y1(t) = 2 \sin(3t)$ as shown.

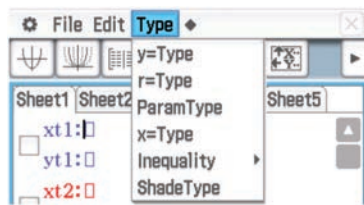

Using the Casio ClassPad

- Open the **Graph & Table** application ().
- From the toolbar, select **Type** > **ParamType**.



- Use the  keyboard to enter the equations as shown on the right.
- Tick the box and tap .
- Use  to adjust the window.

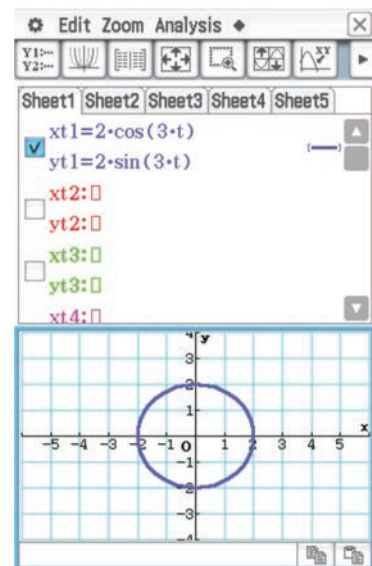

Exercise 1E

Skillsheet

- 1** Find the Cartesian equation of the curve with parametric equations $x = 2 \cos(3t)$ and $y = 2 \sin(3t)$, and determine the domain and range of the corresponding relation.

Example 20

- 2** A curve is defined parametrically by the equations $x = 4t^2$ and $y = 8t$ for $t \in \mathbb{R}$. Find:
- the Cartesian equation of the curve
 - the equation of the line passing through the points where $t = 1$ and $t = -1$
 - the length of the chord joining the points where $t = 1$ and $t = -3$.

Example 22

- 3** Find the Cartesian equation of the curve with parametric equations $x = 2 + 3 \sin t$ and $y = 3 - 2 \cos t$ for $t \in \mathbb{R}$, and describe the graph.

Example 23

- 4** Find the Cartesian equation of the curve with parametric equations $x = 2 \sec t$ and $y = 3 \tan t$ for $t \in \left(\frac{\pi}{2}, \frac{3\pi}{2}\right)$, and describe the curve.

- 5** Find the corresponding Cartesian equation for each pair of parametric equations:

- | | |
|--|--|
| a $x = 4 \cos(2t)$ and $y = 4 \sin(2t)$ | b $x = 2 \sin(2t)$ and $y = 2 \cos(2t)$ |
| c $x = 4 \cos t$ and $y = 3 \sin t$ | d $x = 4 \sin t$ and $y = 3 \cos t$ |
| e $x = 2 \tan(2t)$ and $y = 3 \sec(2t)$ | f $x = 1 - t$ and $y = t^2 - 4$ |
| g $x = t + 2$ and $y = \frac{1}{t}$ | h $x = t^2 - 1$ and $y = t^2 + 1$ |
| i $x = t - \frac{1}{t}$ and $y = 2\left(t + \frac{1}{t}\right)$ | |

- 6** For each of the following pairs of parametric equations, determine the Cartesian equation of the curve and sketch its graph:

- | | |
|---|---|
| a $x = \sec t$, $y = \tan t$, $t \in \left(\frac{\pi}{2}, \frac{3\pi}{2}\right)$ | b $x = 3 \cos(2t)$, $y = -4 \sin(2t)$ |
| c $x = 3 - 3 \cos t$, $y = 2 + 2 \sin t$ | d $x = 3 \sin t$, $y = 4 \cos t$, $t \in \left[-\frac{\pi}{2}, \frac{\pi}{2}\right]$ |
| e $x = \sec t$, $y = \tan t$, $t \in \left(-\frac{\pi}{2}, \frac{\pi}{2}\right)$ | |
| f $x = 1 - \sec(2t)$, $y = 1 + \tan(2t)$, $t \in \left(\frac{\pi}{4}, \frac{3\pi}{4}\right)$ | |

- 7** A circle is defined by the parametric equations

$$x = 2 \cos(2t) \quad \text{and} \quad y = -2 \sin(2t) \quad \text{for } t \in \mathbb{R}$$

- Find the coordinates of the point P on the circle where $t = \frac{4\pi}{3}$.
- Find the equation of the tangent to the circle at P .

Example 24

8 Give parametric equations corresponding to each of the following:

a $x^2 + y^2 = 16$

b $\frac{x^2}{9} - \frac{y^2}{4} = 1$

c $(x - 1)^2 + (y + 2)^2 = 9$

d $\frac{(x - 1)^2}{9} + \frac{(y + 3)^2}{4} = 9$

9 A circle has centre $(1, 3)$ and radius 2. If parametric equations for this circle are $x = a + b \cos(2\pi t)$ and $y = c + d \sin(2\pi t)$, where a, b, c and d are positive constants, state the values of a, b, c and d .

10 An ellipse has x -axis intercepts $(-4, 0)$ and $(4, 0)$ and y -axis intercepts $(0, 3)$ and $(0, -3)$. State a possible pair of parametric equations for this ellipse.

11 The circle with parametric equations $x = 2 \cos(2t)$ and $y = 2 \sin(2t)$ is dilated by a factor of 3 from the x -axis. For the image curve, state:

a a possible pair of parametric equations

b the Cartesian equation.

12 The ellipse with parametric equations $x = 3 - 2 \cos\left(\frac{t}{2}\right)$ and $y = 4 + 3 \sin\left(\frac{t}{2}\right)$ is translated 3 units in the negative direction of the x -axis and 2 units in the negative direction of the y -axis. For the image curve, state:

a a possible pair of parametric equations

b the Cartesian equation.



13 Sketch the graph of the curve with parametric equations $x = 2 + 3 \sin(2\pi t)$ and $y = 4 + 2 \cos(2\pi t)$ for:



a $t \in [0, \frac{1}{4}]$

b $t \in [0, \frac{1}{2}]$

c $t \in [0, \frac{3}{2}]$

For each of these graphs, state the domain and range.

Chapter summary



Triangles

■ Labelling triangles

- Interior angles are denoted by uppercase letters.
- The length of the side opposite an angle is denoted by the corresponding lowercase letter.

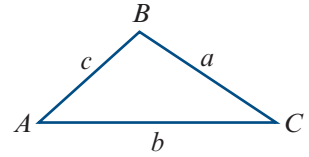

■ Sine rule

For triangle ABC :

$$\frac{a}{\sin A} = \frac{b}{\sin B} = \frac{c}{\sin C}$$

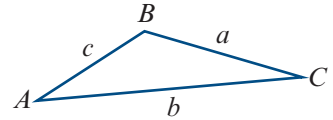

■ Cosine rule

For triangle ABC :

$$a^2 = b^2 + c^2 - 2bc \cos A$$

$$\cos A = \frac{b^2 + c^2 - a^2}{2bc}$$

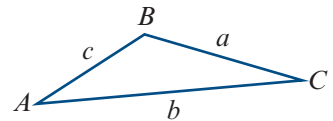

The symmetrical results also hold:

$$b^2 = a^2 + c^2 - 2ac \cos B$$

$$c^2 = a^2 + b^2 - 2ab \cos C$$

Circles

- The circle with centre at the origin and radius a has Cartesian equation $x^2 + y^2 = a^2$.
- The circle with centre (h, k) and radius a has equation $(x - h)^2 + (y - k)^2 = a^2$.

Ellipses

- The curve with equation $\frac{x^2}{a^2} + \frac{y^2}{b^2} = 1$ is an ellipse centred at the origin with axis intercepts $(\pm a, 0)$ and $(0, \pm b)$.

$a > b$

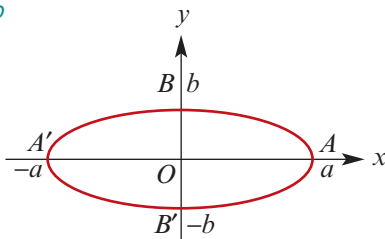

$b > a$

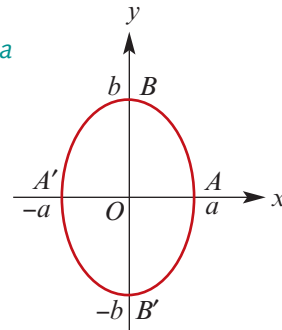

- The curve with equation $\frac{(x - h)^2}{a^2} + \frac{(y - k)^2}{b^2} = 1$ is an ellipse with centre (h, k) .

Hyperbolas

- The curve with equation $\frac{x^2}{a^2} - \frac{y^2}{b^2} = 1$ is a hyperbola centred at the origin.
 - The axis intercepts are $(\pm a, 0)$.
 - The asymptotes have equations $y = \pm \frac{b}{a}x$.

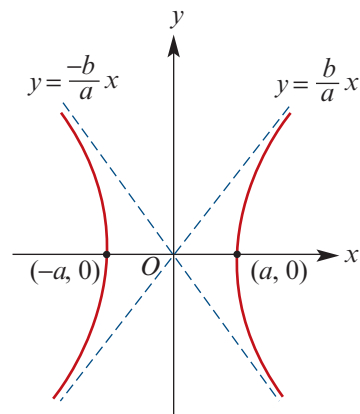

- The curve with equation $\frac{(x-h)^2}{a^2} - \frac{(y-k)^2}{b^2} = 1$ is a hyperbola with centre (h, k) . The asymptotes have equations $y - k = \frac{b}{a}(x - h)$ and $y - k = -\frac{b}{a}(x - h)$.

Parametric equations

- A **parametric curve** in the plane is defined by a pair of functions

$$x = f(t) \quad \text{and} \quad y = g(t)$$

where t is called the **parameter** of the curve.

- Parameterisations of familiar curves:

	Cartesian equation	Parametric equations
Circle	$x^2 + y^2 = a^2$	$x = a \cos t$ and $y = a \sin t$
Ellipse	$\frac{x^2}{a^2} + \frac{y^2}{b^2} = 1$	$x = a \cos t$ and $y = b \sin t$
Hyperbola	$\frac{x^2}{a^2} - \frac{y^2}{b^2} = 1$	$x = a \sec t$ and $y = b \tan t$

Note: To obtain the entire circle or the entire ellipse using these parametric equations, it suffices to take $t \in [0, 2\pi]$.

- Translations of parametric curves: The circle with equation $(x-h)^2 + (y-k)^2 = a^2$ can also be described by the parametric equations $x = h + a \cos t$ and $y = k + a \sin t$.

Short-answer questions

- 1 a Find $\sin \theta^\circ$.

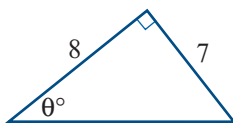

- b Find x .

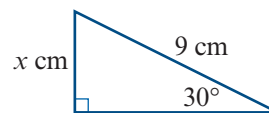

- 2 a Find the exact value of $\cos 315^\circ$.

- b Given that $\tan x^\circ = \frac{3}{4}$ and $180 < x < 270$, find the exact value of $\cos x^\circ$.

- c Find an angle A° (with $A \neq 330$) such that $\sin A^\circ = \sin 330^\circ$.

- 3 Write down the equation of the ellipse shown.

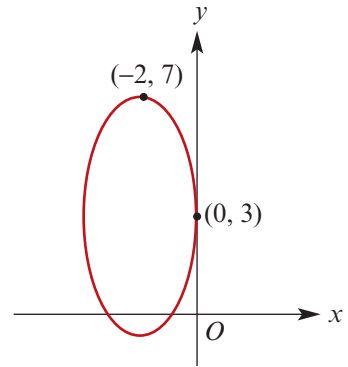

- 4 ABC is a horizontal right-angled triangle with the right angle at B . The point P is 3 cm directly above B . The length of AB is 1 cm and the length of BC is 1 cm. Find the angle that the triangle ACP makes with the horizontal.

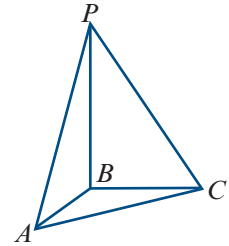

- 5 **a** Solve $2 \cos(2x + \pi) - 1 = 0$ for $-\pi \leq x \leq \pi$.
b Sketch the graph of $y = 2 \cos(2x + \pi) - 1$ for $-\pi \leq x \leq \pi$, clearly labelling the axis intercepts.
c Solve $2 \cos(2x + \pi) < 1$ for $-\pi \leq x \leq \pi$.
- 6 Two ships sail from port at the same time. One sails 24 nautical miles due east in 3 hours, and the other sails 33 nautical miles on a bearing of 030° in the same time.
a How far apart are the ships 3 hours after leaving port?
b How far apart would they be in 5 hours if they maintained the same bearings and constant speed?

- 7 Find x .

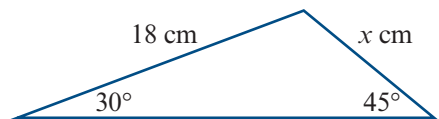

- 8 An airport A is 480 km due east of airport B . A pilot flies on a bearing of 225° from A to C and then on a bearing of 315° from C to B .
a Make a sketch of the situation.
b Determine how far the pilot flies from A to C .
c Determine the total distance the pilot flies.
- 9 Find the equations of the asymptotes of the hyperbola with rule $x^2 - \frac{(y-2)^2}{9} = 15$.
- 10 A curve is defined by the parametric equations $x = 3 \cos(2t) + 4$ and $y = \sin(2t) - 6$. Give the Cartesian equation of the curve.
- 11 A curve is defined by the parametric equations $x = 2 \cos(\pi t)$ and $y = 2 \sin(\pi t) + 2$. Give the Cartesian equation of the curve.

- 12 a** Sketch the graphs of $y = -2 \cos x$ and $y = -2 \cos\left(x - \frac{\pi}{4}\right)$ on the same set of axes, for $x \in [0, 2\pi]$.
- b** Solve $-2 \cos\left(x - \frac{\pi}{4}\right) = 0$ for $x \in [0, 2\pi]$. **c** Solve $-2 \cos x \leq 0$ for $x \in [0, 2\pi]$.
- 13** Find all angles θ with $0 \leq \theta \leq 2\pi$, where:
- a** $\sin \theta = \frac{1}{2}$ **b** $\cos \theta = \frac{\sqrt{3}}{2}$ **c** $\tan \theta = 1$
- 14** A circle has centre $(1, 2)$ and radius 3. If parametric equations for this circle are $x = a + b \cos(2\pi t)$ and $y = c + d \sin(2\pi t)$, where a, b, c and d are positive constants, state the values of a, b, c and d .
- 15** Find the centre and radius of the circle with equation $x^2 + 8x + y^2 - 12y + 3 = 0$.
-  **16** Find the x - and y -axis intercepts of the ellipse with equation $\frac{x^2}{81} + \frac{y^2}{9} = 1$.

Multiple-choice questions

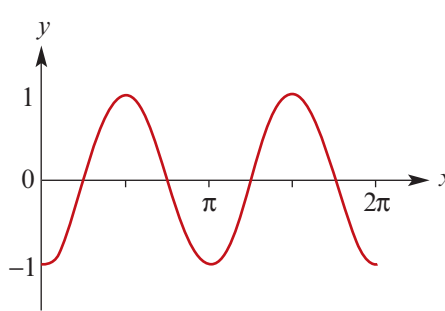

- 1** If $2 \cos x^\circ - \sqrt{2} = 0$, then the value of the acute angle x° is
- A** 30° **B** 60° **C** 45° **D** 25° **E** 27.5°
- 2** The equation of the graph shown is
- A** $y = \sin\left(2\left(x - \frac{\pi}{4}\right)\right)$
B $y = \cos\left(x + \frac{\pi}{4}\right)$
C $y = \sin(2x)$
D $y = -2 \sin(x)$
E $y = \sin\left(x + \frac{\pi}{4}\right)$
- 
- 3** The exact value of the expression $\sin\left(\frac{2\pi}{3}\right) \times \cos\left(\frac{\pi}{4}\right) \times \tan\left(\frac{\pi}{6}\right)$ is
- A** $\frac{1}{2}$ **B** $\frac{1}{\sqrt{3}}$ **C** $\frac{\sqrt{2}}{4}$ **D** $\frac{\sqrt{3}}{2}$ **E** none of these
- 4** In a triangle ABC , $a = 30$, $b = 21$ and $\cos C = \frac{51}{53}$. The value of c to the nearest whole number is
- A** 9 **B** 10 **C** 11 **D** 81 **E** 129
- 5** For a triangle ABC , if $A = 45^\circ$, $B = 105^\circ$ and $a = 1$, then c equals
- A** $\frac{1}{\sqrt{2}}$ **B** $\frac{\sqrt{3}}{\sqrt{2}}$ **C** $\frac{1}{2\sqrt{2}}$ **D** $2\sqrt{2}$ **E** $\sqrt{2}$
- 6** The coordinates of the centre of the circle with equation $x^2 - 8x + y^2 - 2y = 8$ are
- A** $(-8, -2)$ **B** $(8, 2)$ **C** $(-4, -1)$ **D** $(4, 1)$ **E** $(1, 4)$

7 The equation of the graph shown is

A $\frac{(x+2)^2}{27} - \frac{y^2}{108} = 1$

B $\frac{(x-2)^2}{9} - \frac{y^2}{34} = 1$

C $\frac{(x+2)^2}{81} - \frac{y^2}{324} = 1$

D $\frac{(x-2)^2}{81} - \frac{y^2}{324} = 1$

E $\frac{(x+2)^2}{9} - \frac{y^2}{36} = 1$

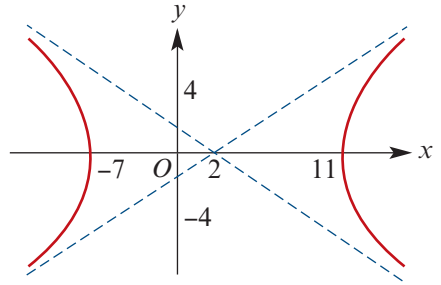

8 Which of the following pairs of parametric equations describes the parabola shown?

A $x = t, y = t^2$

B $x = t, y = \sqrt{t}$

C $x = t^2, y = t$

D $x = -t^2, y = t$

E $x = t, y = -t^2$

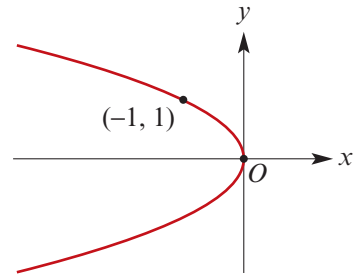

Extended-response questions

- 1 a Find the values of a, y, z, w and x .
 b Hence deduce exact values for $\sin 15^\circ, \cos 15^\circ$ and $\tan 15^\circ$.
 c Find the exact values of $\sin 75^\circ, \cos 75^\circ$ and $\tan 75^\circ$.

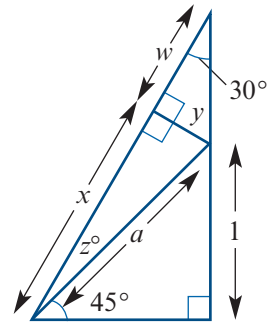

- 2 A hiker walks from point A on a bearing of 010° for 5 km and then on a bearing of 075° for 7 km to reach point B .

- a Find the length of AB .
 b Find the bearing of B from the start point A .

A second hiker walks from point A on a bearing of 080° for 4 km to a point P , and then walks in a straight line to B .

- c i Find the total distance travelled by the second hiker.
 ii Find the bearing on which the hiker must travel in order to reach B from P .

A third hiker also walks from point A on a bearing of 080° and continues on that bearing until he reaches point C . He then turns and walks towards B . In doing so, the two legs of the journey are of equal length.

- d Find the total distance travelled by the third hiker to reach B .

3 An ellipse is defined by the rule $\frac{x^2}{2} + \frac{(y+3)^2}{5} = 1$.

- a** Find:
- i** the domain of the relation
 - ii** the range of the relation
 - iii** the centre of the ellipse.

An ellipse E is given by the rule $\frac{(x-h)^2}{a^2} + \frac{(y-k)^2}{b^2} = 1$. The domain of E is $[-1, 3]$ and its range is $[-1, 5]$.

b Find the values of a , b , h and k .

The line $y = x - 2$ intersects the ellipse E at $A(1, -1)$ and at P .

c Find the coordinates of the point P .

A line perpendicular to the line $y = x - 2$ is drawn at P . This line intersects the y -axis at the point Q .

d Find the coordinates of Q .

e Find the equation of the circle through A , P and Q .

4 a Show that the circle with equation $x^2 + y^2 - 2ax - 2ay + a^2 = 0$ touches both the x -axis and the y -axis.

b Show that every circle that touches both the x -axis and the y -axis has an equation of a similar form.

c Hence show that there are exactly two circles that pass through the point $(2, 4)$ and just touch the x -axis and the y -axis, and give their equations.

d For each of these two circles, state the coordinates of the centre and give the radius.

e For each circle, find the gradient of the line which passes through the centre and the point $(2, 4)$.

f For each circle, find the equation of the tangent to the circle at the point $(2, 4)$.

5 A circle is defined by the parametric equations $x = a \cos t$ and $y = a \sin t$. Let P be the point with coordinates $(a \cos t, a \sin t)$.

a Find the equation of the straight line which passes through the origin and the point P .

b State the coordinates, in terms of t , of the other point of intersection of the circle with the straight line through the origin and P .

c Find the equation of the tangent to the circle at the point P .

d Find the coordinates of the points of intersection A and B of the tangent with the x -axis and the y -axis respectively.

e Find the area of triangle OAB in terms of t if $0 < t < \frac{\pi}{2}$. Find the value of t for which the area of this triangle is a minimum.

6 The perimeter of a triangle ABC is L metres. Find the area of the triangle in terms of L and the triangle's angles α , β and γ .

Hint: Let $AB = x$. Using the sine rule, first find the other side lengths in terms of x .



2

Composite and inverse functions

Objectives

- ▶ To understand the **modulus function** $y = |x|$.
- ▶ To sketch graphs of functions with rules of the form $y = |f(x)|$ and $y = f(|x|)$.
- ▶ To define and use **composite functions**.
- ▶ To decide whether or not a given function is **one-to-one**.
- ▶ To find the **inverse** of a one-to-one function.
- ▶ To understand the relationship between the graph of a one-to-one function and the graph of its inverse.

In this chapter, we build on your study of functions from Mathematical Methods. We focus on three topics that will be used throughout the rest of the book.

The modulus function

The modulus function is useful in many contexts. For example, it enables us to talk about the distance between two points on the real number line. We will use the modulus function in our study of integration and differential equations. We will also generalise the modulus function to both vectors and complex numbers.

Composition of functions

An understanding of composition allows us to view a complicated function as a combination of two simpler functions. We will use composition when applying the chain rule for differentiation, which in turn will be applied to the study of related rates.

Inverse functions

An understanding of inverse functions is very useful when solving equations. In the next chapter, you will meet the inverse circular functions, which will later be applied in integration.

2A The modulus function

The **modulus** or **absolute value** of a real number x is denoted by $|x|$ and is defined by

$$|x| = \begin{cases} x & \text{if } x \geq 0 \\ -x & \text{if } x < 0 \end{cases}$$

It may also be defined as $|x| = \sqrt{x^2}$. For example: $|5| = 5$ and $|-5| = 5$.

Example 1

Evaluate each of the following:

a i $|-3 \times 2|$

ii $|-3| \times |2|$

b i $\left| \frac{-4}{2} \right|$

ii $\frac{|-4|}{|2|}$

c i $|-6 + 2|$

ii $|-6| + |2|$

Solution

a i $|-3 \times 2| = |-6| = 6$

ii $|-3| \times |2| = 3 \times 2 = 6$

Note: $|-3 \times 2| = |-3| \times |2|$

b i $\left| \frac{-4}{2} \right| = |-2| = 2$

ii $\frac{|-4|}{|2|} = \frac{4}{2} = 2$

Note: $\left| \frac{-4}{2} \right| = \frac{|-4|}{|2|}$

c i $|-6 + 2| = |-4| = 4$

ii $|-6| + |2| = 6 + 2 = 8$

Note: $|-6 + 2| \neq |-6| + |2|$

Properties of the modulus function

■ $|ab| = |a||b|$ and $\left| \frac{a}{b} \right| = \frac{|a|}{|b|}$

■ $|x| = a$ implies $x = a$ or $x = -a$

■ $|a + b| \leq |a| + |b|$

■ If a and b are both positive or both negative, then $|a + b| = |a| + |b|$.

■ If $a \geq 0$, then $|x| \leq a$ is equivalent to $-a \leq x \leq a$.

■ If $a \geq 0$, then $|x - k| \leq a$ is equivalent to $k - a \leq x \leq k + a$.

► The modulus function as a measure of distance

Consider two points A and B on a number line:

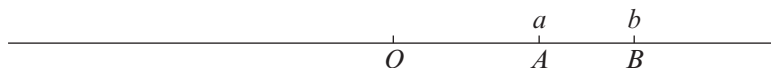

On a number line, the distance between points A and B is $|a - b| = |b - a|$.

Thus $|x - 2| \leq 3$ can be read as ‘on the number line, the distance of x from 2 is less than or equal to 3’, and $|x| \leq 3$ can be read as ‘on the number line, the distance of x from the origin is less than or equal to 3’. Note that $|x| \leq 3$ is equivalent to $-3 \leq x \leq 3$ or $x \in [-3, 3]$.

Example 2

Illustrate each of the following sets on a number line and represent the sets using interval notation:

- a** $\{x : |x| < 4\}$ **b** $\{x : |x| \geq 4\}$ **c** $\{x : |x - 1| \leq 4\}$

Solution

a $(-4, 4)$

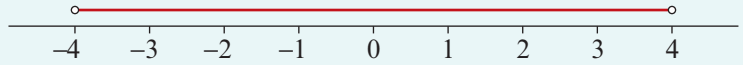

b $(-\infty, -4] \cup [4, \infty)$

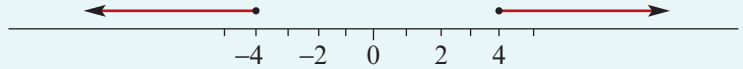

c $[-3, 5]$



► **The graph of $y = |x|$**

The graph of the function $f: \mathbb{R} \rightarrow \mathbb{R}$, $f(x) = |x|$ is shown here.

This graph is symmetric about the y -axis, since $|x| = |-x|$.

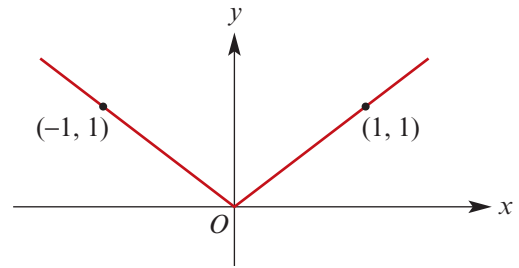

Example 3

For each of the following functions, sketch the graph and state the range:

- a** $f(x) = |x - 3| + 1$ **b** $f(x) = -|x - 3| + 1$

Solution

Note that $|a - b| = a - b$ if $a \geq b$, and $|a - b| = b - a$ if $b \geq a$.

$$\begin{aligned} \mathbf{a} \quad f(x) = |x - 3| + 1 &= \begin{cases} x - 3 + 1 & \text{if } x \geq 3 \\ 3 - x + 1 & \text{if } x < 3 \end{cases} \\ &= \begin{cases} x - 2 & \text{if } x \geq 3 \\ 4 - x & \text{if } x < 3 \end{cases} \end{aligned}$$

Range = $[1, \infty)$

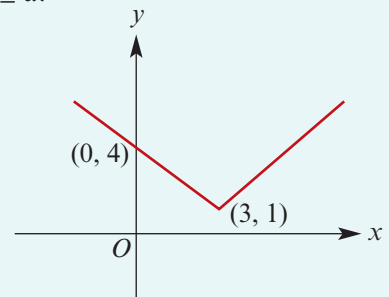

$$\begin{aligned} \mathbf{b} \quad f(x) = -|x - 3| + 1 &= \begin{cases} -(x - 3) + 1 & \text{if } x \geq 3 \\ -(3 - x) + 1 & \text{if } x < 3 \end{cases} \\ &= \begin{cases} -x + 4 & \text{if } x \geq 3 \\ -2 + x & \text{if } x < 3 \end{cases} \end{aligned}$$

Range = $(-\infty, 1]$

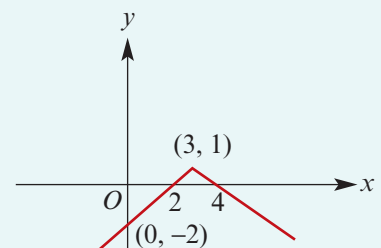

Using the TI-Nspire

- Use **menu** > **Actions** > **Define** to define the function $f(x) = \text{abs}(x - 3) + 1$.

Note: The absolute value function can be obtained by typing **abs()** or using the 2D-template palette .

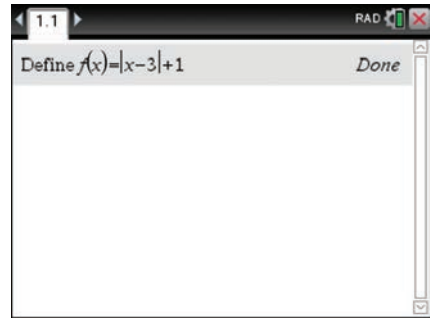

- Open a **Graphs** application (**ctrl** **I** > **Graphs**) and let $f1(x) = f(x)$.
- Press **enter** to obtain the graph.

Note: The expression $\text{abs}(x - 3) + 1$ could have been entered directly for $f1(x)$.

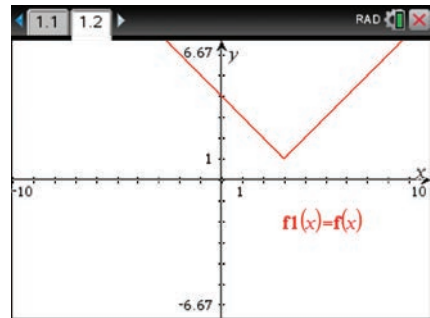



Using the Casio ClassPad

- In $\sqrt{\alpha}$, enter the expression $|x - 3| + 1$.

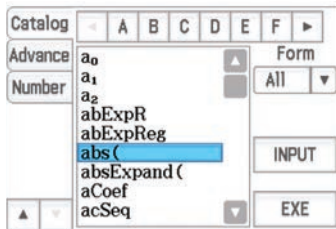
Note: To obtain the absolute value function, either choose **abs()** from the catalog (as shown below) or select  from the **Math1** keyboard.



- Tap  to open the graph window.
- Highlight $|x - 3| + 1$ and drag into the graph window.
- Select **Zoom** > **Initialize** or use  to adjust the window manually.

Note: Alternatively, the function can be graphed using the **Graph & Table** application. Enter the expression in $y1$, tick the box and tap .

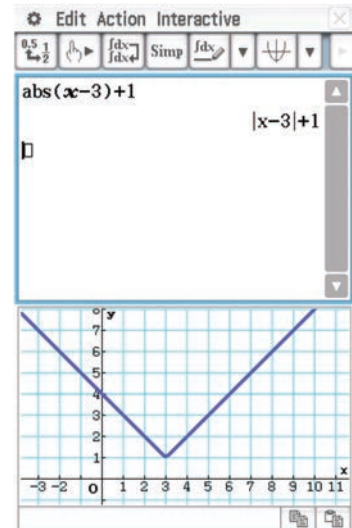

► **Functions with rules of the form $y = |f(x)|$ and $y = f(|x|)$**

If the graph of $y = f(x)$ is known, then we can sketch the graph of $y = |f(x)|$ using the following observation:

$$|f(x)| = f(x) \text{ if } f(x) \geq 0 \quad \text{and} \quad |f(x)| = -f(x) \text{ if } f(x) < 0$$



Example 4

Sketch the graph of each of the following:

a $y = |x^2 - 4|$

b $y = |2^x - 1|$

Solution

a

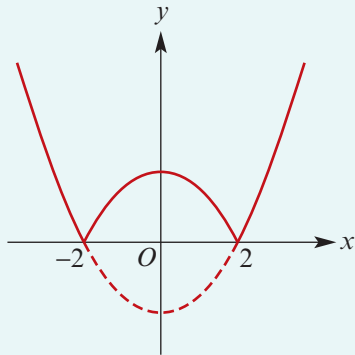

The graph of $y = x^2 - 4$ is drawn and the negative part reflected in the x -axis.

b

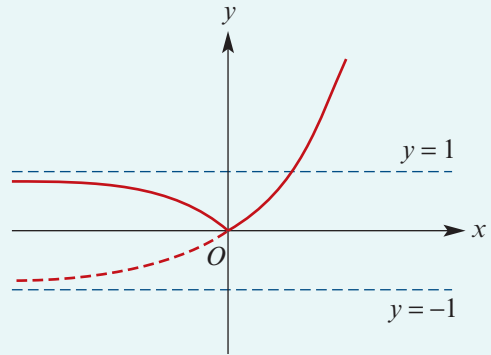

The graph of $y = 2^x - 1$ is drawn and the negative part reflected in the x -axis.

The graph of $y = f(|x|)$, for $x \in \mathbb{R}$, is sketched by reflecting the graph of $y = f(x)$, for $x \geq 0$, in the y -axis.



Example 5

Sketch the graph of each of the following:

a $y = |x^2 - 2|x||$

b $y = 2^{|x|}$

Solution

a

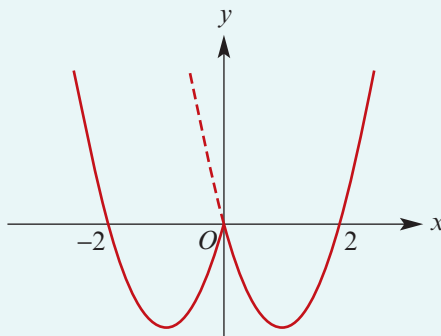

The graph of $y = x^2 - 2x$, $x \geq 0$, is reflected in the y -axis.

b

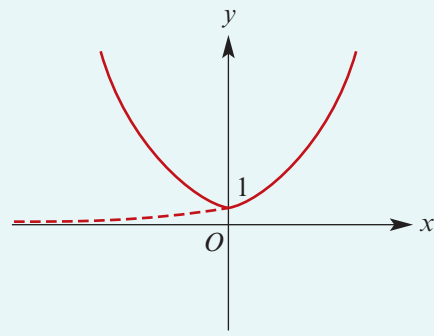

The graph of $y = 2^x$, $x \geq 0$, is reflected in the y -axis.

Exercise 2A

Skillsheet

1 Evaluate each of the following:

Example 1

a $|-5| + 3$ **b** $|-5| + |-3|$ **c** $|-5| - |-3|$
d $|-5| - |-3| - 4$ **e** $|-5| - |-3| - |-4|$ **f** $|-5| + |-3| - |-4|$

2 Solve each of the following equations for x :

a $|x - 1| = 2$ **b** $|2x - 3| = 4$ **c** $|5x - 3| = 9$ **d** $|x - 3| - 9 = 0$
e $|3 - x| = 4$ **f** $|3x + 4| = 8$ **g** $|5x + 11| = 9$

Example 2

3 For each of the following, illustrate the set on a number line and represent the set using interval notation:

a $\{x : |x| < 3\}$ **b** $\{x : |x| \geq 5\}$ **c** $\{x : |x - 2| \leq 1\}$
d $\{x : |x - 2| < 3\}$ **e** $\{x : |x + 3| \geq 5\}$ **f** $\{x : |x + 2| \leq 1\}$

Example 3

4 For each of the following functions, sketch the graph and state the range:

a $f(x) = |x - 4| + 1$ **b** $f(x) = -|x + 3| + 2$
c $f(x) = |x + 4| - 1$ **d** $f(x) = 2 - |x - 1|$

5 Solve each of the following inequalities, giving your answer using set notation:

a $\{x : |x| \leq 5\}$ **b** $\{x : |x| \geq 2\}$ **c** $\{x : |2x - 3| \leq 1\}$
d $\{x : |5x - 2| < 3\}$ **e** $\{x : |-x + 3| \geq 7\}$ **f** $\{x : |-x + 2| \leq 1\}$

6 Solve each of the following for x :

a $|x - 4| - |x + 2| = 6$ **b** $|2x - 5| - |4 - x| = 10$ **c** $|2x - 1| + |4 - 2x| = 10$

Example 4

7 Sketch the graph of each of the following:

a $y = |x^2 - 9|$ **b** $y = |3^x - 3|$ **c** $y = |x^2 - x - 12|$
d $y = |x^2 - 3x - 40|$ **e** $y = |x^2 - 2x - 8|$ **f** $y = |2^x - 4|$

Example 5

8 Sketch the graph of each of the following:

a $y = |x|^2 - 4|x|$ **b** $y = 3^{|x|}$ **c** $y = |x|^2 - 7|x| + 12$
d $y = |x|^2 - |x| - 12$ **e** $y = |x|^2 + |x| - 12$ **f** $y = -3^{|x|} + 1$

9 If $f(x) = |x - a| + b$ with $f(3) = 3$ and $f(-1) = 3$, find the values of a and b .

10 Prove that $|x - y| \leq |x| + |y|$.

11 Prove that $|x| - |y| \leq |x - y|$.



12 Prove that $|x + y + z| \leq |x| + |y| + |z|$.

2B Composite functions

A function may be considered to be similar to a machine for which the input (domain) is processed to produce an output (range). For example, the diagram on the right represents an ‘ f -machine’ where $f(x) = 3x + 2$.

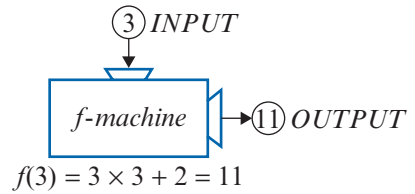

With many processes, more than one machine operation is required to produce an output.

Suppose an output is the result of one function being applied after another.

For example: $f(x) = 3x + 2$
followed by $g(x) = x^2$

This is illustrated on the right.

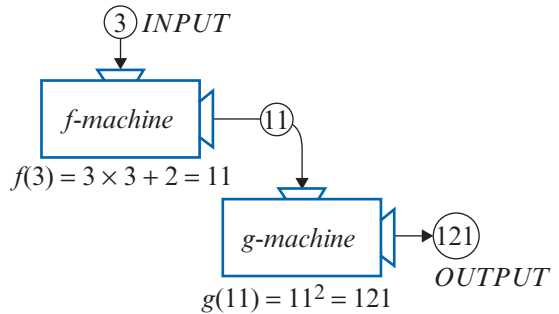

A new function h is formed. The rule for h is $h(x) = (3x + 2)^2$.

The diagram shows $f(3) = 11$ and then $g(11) = 121$.
This may be written:

$$h(3) = g(f(3)) = g(11) = 121$$

The new function h is said to be the **composition** of g with f . This is written $h = g \circ f$ (read ‘composition of f followed by g ’) and the rule for h is given by $h(x) = g(f(x))$.

In the example we have considered:

$$h(x) = g(f(x)) = g(3x + 2) = (3x + 2)^2$$

Note: For any function f , we denote the domain of f by **dom** f and the range of f by **ran** f .

Composite function

In general, for functions f and g such that

$$\text{ran } f \subseteq \text{dom } g$$

we define the **composite function** of g with f by

$$g \circ f(x) = g(f(x))$$

$$\text{dom}(g \circ f) = \text{dom } f$$

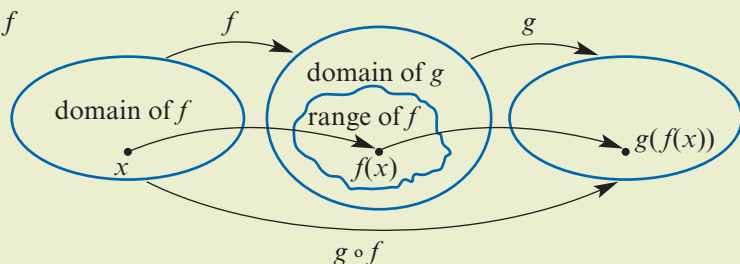



Example 6

Find both $f \circ g$ and $g \circ f$, stating the domain and range of each, where:

$$f: \mathbb{R} \rightarrow \mathbb{R}, f(x) = 2x - 1 \quad \text{and} \quad g: \mathbb{R} \rightarrow \mathbb{R}, g(x) = 3x^2$$

Solution

To determine the existence of a composite function, it is useful to form a table of domains and ranges.

	Domain	Range
g	\mathbb{R}	$\mathbb{R}^+ \cup \{0\}$
f	\mathbb{R}	\mathbb{R}

We see that $f \circ g$ is defined since $\text{ran } g \subseteq \text{dom } f$, and that $g \circ f$ is defined since $\text{ran } f \subseteq \text{dom } g$.

$$\begin{aligned} f \circ g(x) &= f(g(x)) \\ &= f(3x^2) \\ &= 2(3x^2) - 1 \\ &= 6x^2 - 1 \end{aligned}$$

$$\begin{aligned} g \circ f(x) &= g(f(x)) \\ &= g(2x - 1) \\ &= 3(2x - 1)^2 \\ &= 12x^2 - 12x + 3 \end{aligned}$$

$$\text{dom}(f \circ g) = \text{dom } g = \mathbb{R}$$

$$\text{ran}(f \circ g) = [-1, \infty)$$

$$\text{dom}(g \circ f) = \text{dom } f = \mathbb{R}$$

$$\text{ran}(g \circ f) = [0, \infty)$$

Note: It can be seen from this example that in general $f \circ g \neq g \circ f$.

Using the TI-Nspire

- Define $f(x) = 2x - 1$ and $g(x) = 3x^2$.
- The rules for $f \circ g$ and $g \circ f$ can now be found using $f(g(x))$ and $g(f(x))$.

Expression	Result
Define $f(x) = 2 \cdot x - 1$	Done
Define $g(x) = 3 \cdot x^2$	Done
$f(g(x))$	$6 \cdot x^2 - 1$
$g(f(x))$	$3 \cdot (2 \cdot x - 1)^2$

Using the Casio ClassPad

- Define $f(x) = 2x - 1$ and $g(x) = 3x^2$.
- The rules for $f \circ g$ and $g \circ f$ can now be found using $f(g(x))$ and $g(f(x))$.

Expression	Result
Define $f(x) = 2 \cdot x - 1$	done
Define $g(x) = 3 \cdot x^2$	done
$f(g(x))$	$6 \cdot x^2 - 1$
$g(f(x))$	$3 \cdot (2 \cdot x - 1)^2$

Example 7

For the functions $g(x) = 2x - 1$, $x \in \mathbb{R}$, and $f(x) = \sqrt{x}$, $x \geq 0$:

- a** State which of $f \circ g$ and $g \circ f$ is defined.
b For the composite function that is defined, state the domain and rule.

Solution

a Range of $f \subseteq$ domain of g

Range of $g \not\subseteq$ domain of f

Thus $g \circ f$ is defined, but $f \circ g$ is not defined.

	Domain	Range
g	\mathbb{R}	\mathbb{R}
f	$\mathbb{R}^+ \cup \{0\}$	$\mathbb{R}^+ \cup \{0\}$

b $g \circ f(x) = g(f(x))$

$$= g(\sqrt{x})$$

$$= 2\sqrt{x} - 1$$

$$\text{dom}(g \circ f) = \text{dom } f = \mathbb{R}^+ \cup \{0\}$$

Example 8

For the functions $f(x) = x^2 - 1$, $x \in \mathbb{R}$, and $g(x) = \sqrt{x}$, $x \geq 0$:

- a** State why $g \circ f$ is not defined.
b Define a restriction f^* of f such that $g \circ f^*$ is defined, and find $g \circ f^*$.

Solution

a Range of $f \not\subseteq$ domain of g

Thus $g \circ f$ is not defined.

	Domain	Range
f	\mathbb{R}	$[-1, \infty)$
g	$\mathbb{R}^+ \cup \{0\}$	$\mathbb{R}^+ \cup \{0\}$

b For $g \circ f^*$ to be defined, we need range of $f^* \subseteq$ domain of g , i.e. range of $f^* \subseteq \mathbb{R}^+ \cup \{0\}$.

For the range of f^* to be a subset of $\mathbb{R}^+ \cup \{0\}$, the domain of f must be restricted to a subset of

$$\{x : x \leq -1\} \cup \{x : x \geq 1\} = \mathbb{R} \setminus (-1, 1)$$

So we define f^* by

$$f^* : \mathbb{R} \setminus (-1, 1) \rightarrow \mathbb{R}, f^*(x) = x^2 - 1$$

Then $g \circ f^*(x) = g(f^*(x))$

$$= g(x^2 - 1)$$

$$= \sqrt{x^2 - 1}$$

$$\text{dom}(g \circ f^*) = \text{dom } f^* = \mathbb{R} \setminus (-1, 1)$$

The composite function is $g \circ f^* : \mathbb{R} \setminus (-1, 1) \rightarrow \mathbb{R}, g \circ f^*(x) = \sqrt{x^2 - 1}$

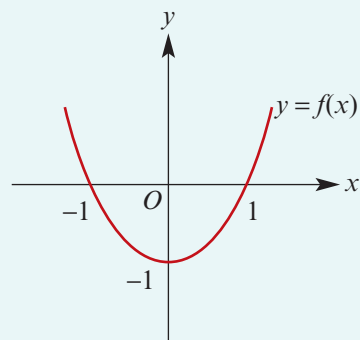

Exercise 2B

Skillsheet

1 For each of the following, find $f(g(x))$ and $g(f(x))$:

Example 6

a $f(x) = 2x - 1$, $g(x) = 2x$

b $f(x) = 4x + 1$, $g(x) = 2x + 1$

c $f(x) = 2x - 1$, $g(x) = 2x - 3$

d $f(x) = 2x - 1$, $g(x) = x^2$

e $f(x) = 2x^2 + 1$, $g(x) = x - 5$

f $f(x) = 2x + 1$, $g(x) = x^2$

2 For the functions $f(x) = 2x - 1$ and $h(x) = 3x + 2$, find:

a $f \circ h(x)$

b $h(f(x))$

c $f \circ h(2)$

d $h \circ f(2)$

e $f(h(3))$

f $h(f(-1))$

g $f \circ h(0)$

3 For the functions $f(x) = x^2 + 2x$ and $h(x) = 3x + 1$, find:

a $f \circ h(x)$

b $h \circ f(x)$

c $f \circ h(3)$

d $h \circ f(3)$

e $f \circ h(0)$

f $h \circ f(0)$

4 For the functions $h: \mathbb{R} \setminus \{0\} \rightarrow \mathbb{R}$, $h(x) = \frac{1}{x^2}$ and $g: \mathbb{R}^+ \rightarrow \mathbb{R}$, $g(x) = 3x + 2$, find:

a $h \circ g$ (state rule and domain)

b $g \circ h$ (state rule and domain)

c $h \circ g(1)$

d $g \circ h(1)$

Example 7

5 Consider the functions $f: \mathbb{R} \rightarrow \mathbb{R}$, $f(x) = x^2 - 4$ and $g: \mathbb{R}^+ \cup \{0\} \rightarrow \mathbb{R}$, $g(x) = \sqrt{x}$.a State the ranges of f and g .b Find $f \circ g$, stating its range.c Explain why $g \circ f$ does not exist.6 Let f and g be functions given by

$$f: \mathbb{R} \setminus \{0\} \rightarrow \mathbb{R}, f(x) = \frac{1}{2} \left(\frac{1}{x} + 1 \right) \quad g: \mathbb{R} \setminus \{ \frac{1}{2} \} \rightarrow \mathbb{R}, g(x) = \frac{1}{2x - 1}$$

a Find $f \circ g$ and state its range.b Find $g \circ f$ and state its range.7 The functions f and g are defined by $f: \mathbb{R} \rightarrow \mathbb{R}$, $f(x) = x^2 - 2$ and $g: [0, \infty) \rightarrow \mathbb{R}$, $g(x) = \sqrt{x}$.a Explain why $g \circ f$ does not exist.b Find $f \circ g$ and sketch its graph.

Example 8

8 $f: (-\infty, 3] \rightarrow \mathbb{R}$, $f(x) = 3 - x$ and $g: \mathbb{R} \rightarrow \mathbb{R}$, $g(x) = x^2 - 1$ a Show that $f \circ g$ is not defined.b Define a restriction g^* of g such that $f \circ g^*$ is defined and find $f \circ g^*$.9 $f: \mathbb{R}^+ \rightarrow \mathbb{R}$, $f(x) = x^{-\frac{1}{2}}$ and $g: \mathbb{R} \rightarrow \mathbb{R}$, $g(x) = 3 - x$ a Show that $f \circ g$ is not defined.b By suitably restricting the domain of g , obtain a function g_1 such that $f \circ g_1$ is defined.

- 10** Let $f: \mathbb{R} \rightarrow \mathbb{R}$, $f(x) = x^2$ and let $g: (-\infty, 3] \rightarrow \mathbb{R}$, $g(x) = \sqrt{3-x}$. State with reasons whether:
- a** $f \circ g$ exists **b** $g \circ f$ exists.
- 11** Let $f: S \rightarrow \mathbb{R}$, $f(x) = \sqrt{4-x^2}$, where S is the set of all real values of x for which $f(x)$ is defined. Let $g: \mathbb{R} \rightarrow \mathbb{R}$, where $g(x) = x^2 + 1$.
- a** Find S .
b Find the range of f and the range of g .
c State whether or not $f \circ g$ and $g \circ f$ are defined and give a reason for each assertion.
- 12** Let a be a positive number, let $f: [2, \infty) \rightarrow \mathbb{R}$, $f(x) = a - x$ and let $g: (-\infty, 1] \rightarrow \mathbb{R}$, $g(x) = x^2 + a$. Find all values of a for which both $f \circ g$ and $g \circ f$ exist.
- 13** For each of the following, find the two composite functions $f \circ g$ and $g \circ f$, and sketch their graphs:
- a** $f(x) = 4 - x$, $g(x) = |x|$ **b** $f(x) = 9 - x^2$, $g(x) = |x|$
- c** $f: \mathbb{R} \setminus \{0\} \rightarrow \mathbb{R}$, $f(x) = \frac{1}{x}$, $g: \mathbb{R} \setminus \{0\} \rightarrow \mathbb{R}$, $g(x) = |x|$



2C One-to-one functions

One-to-one function

A function is said to be **one-to-one** if different x -values map to different y -values.

That is, a function f is one-to-one if $a \neq b$ implies $f(a) \neq f(b)$, for all $a, b \in \text{dom } f$.

An equivalent way to say this is that a function f is one-to-one if $f(a) = f(b)$ implies $a = b$, for all $a, b \in \text{dom } f$. The function $f(x) = 2x + 1$ is one-to-one because

$$\begin{aligned} f(a) = f(b) &\Rightarrow 2a + 1 = 2b + 1 \\ &\Rightarrow 2a = 2b \\ &\Rightarrow a = b \end{aligned}$$

The function $f(x) = x^2$ is not one-to-one as, for example, $f(3) = 9 = f(-3)$.

Example 9

Which of the following functions are one-to-one?

- a** $f = \{(2, -3), (4, 7), (6, 6), (8, 10)\}$ **b** $g = \{(1, 4), (2, 5), (3, 4), (4, 7)\}$

Solution

- a** The function f is one-to-one, as the second coordinates of the ordered pairs are all different. **b** The function g is not one-to-one, as the second coordinates of the ordered pairs are not all different: $g(1) = 4 = g(3)$.

The vertical-line test can be used to determine whether a relation is a function or not. Similarly, there is a geometric test that determines whether a function is one-to-one or not.

Horizontal-line test

If a horizontal line can be drawn anywhere on the graph of a function and it only ever intersects the graph a maximum of once, then the function is **one-to-one**.

Example 10

Which of the following functions are one-to-one?

a $y = x^2$

b $y = x^3$

c $y = \frac{1}{x}$

Solution

a not one-to-one

b one-to-one

c one-to-one

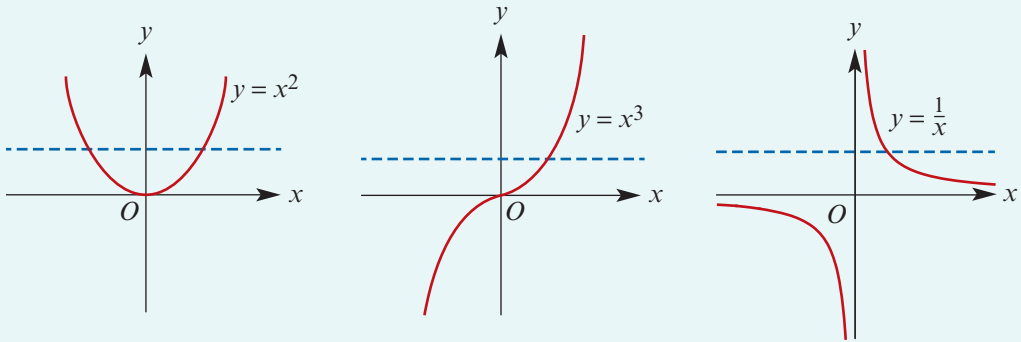

A function that is not one-to-one is **many-to-one**.

Exercise 2C

Example 9 1 State which of the following functions are one-to-one:

a $\{(2, 3), (3, 4), (5, 4), (4, 6)\}$

b $\{(1, 2), (2, 3), (3, 4), (4, 6)\}$

c $\{(7, -3), (11, 5), (6, 4), (17, -6), (12, -4)\}$

d $\{(-1, -2), (-2, -2), (-3, 4), (-6, 7)\}$

Example 10 2 State which of the following functions are one-to-one:

a $\{(x, y) : y = x^2 + 2\}$

b $\{(x, y) : y = 2x + 4\}$

c $f(x) = 2 - x^2$

d $y = x^2, x \geq 1$

e $y = \frac{1}{x^2}, x \neq 0$

f $y = (x - 1)^3$

g $f(x) = 5$

h $f(x) = \sqrt{2 - x}, x \leq 2$

i $y = |2 - x|$

- 3 Each of the following is the graph of a function. State which are the graph of a one-to-one function.

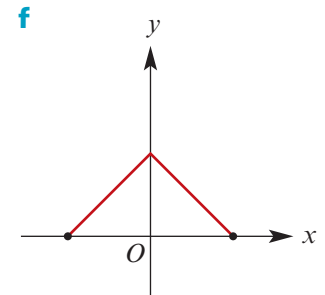
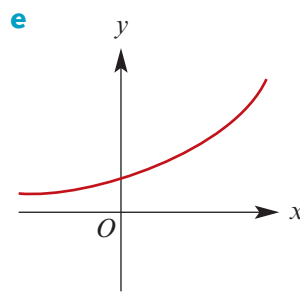
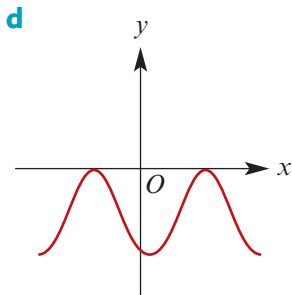
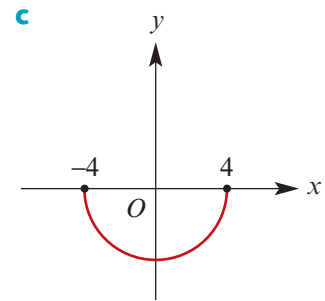
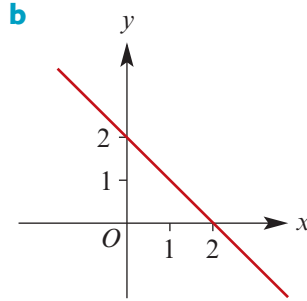
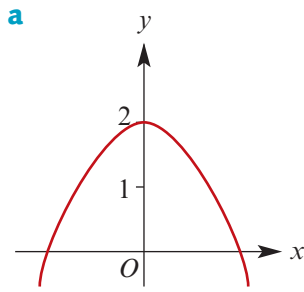

- 4 **a** Draw the graph of $g: \mathbb{R} \rightarrow \mathbb{R}$, $g(x) = x^2 + 2$.

- b** By restricting the domain of g , form two one-to-one functions that have the same rule as g .



2D Inverse functions



If f is a one-to-one function, then for each number y in the range of f there is exactly one number x in the domain of f such that $f(x) = y$.

Thus if f is a one-to-one function, then a new function f^{-1} , called the **inverse** of f , may be defined by:

$$f^{-1}(x) = y \text{ if } f(y) = x, \quad \text{for } x \in \text{ran } f \text{ and } y \in \text{dom } f$$

Note: The function f^{-1} is also a one-to-one function, and f is the inverse of f^{-1} .

It is not difficult to see what the relation between f and f^{-1} means geometrically. The point (x, y) is on the graph of f^{-1} if the point (y, x) is on the graph of f . Therefore to get the graph of f^{-1} from the graph of f , the graph of f is to be reflected in the line $y = x$.

From this the following is evident:

$$\begin{aligned} \text{dom } f^{-1} &= \text{ran } f \\ \text{ran } f^{-1} &= \text{dom } f \end{aligned}$$

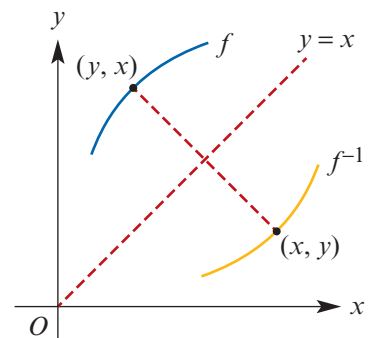

A function has an inverse function if and only if it is one-to-one. Using the notation for composition we can write:

$$f \circ f^{-1}(x) = x, \quad \text{for all } x \in \text{dom } f^{-1}$$

$$f^{-1} \circ f(x) = x, \quad \text{for all } x \in \text{dom } f$$

Example 11

Find the inverse function f^{-1} of the function $f(x) = 2x - 3$.

Solution

Method 1

The graph of f has equation $y = 2x - 3$ and the graph of f^{-1} has equation $x = 2y - 3$, that is, x and y are interchanged.

Solve for y :

$$x = 2y - 3$$

$$x + 3 = 2y$$

$$\therefore y = \frac{1}{2}(x + 3)$$

Thus $f^{-1}(x) = \frac{1}{2}(x + 3)$ and $\text{dom } f^{-1} = \text{ran } f = \mathbb{R}$.

Method 2

We require f^{-1} such that

$$f(f^{-1}(x)) = x$$

$$2f^{-1}(x) - 3 = x$$

$$\therefore f^{-1}(x) = \frac{1}{2}(x + 3)$$

Thus $f^{-1}(x) = \frac{1}{2}(x + 3)$ and $\text{dom } f^{-1} = \text{ran } f = \mathbb{R}$.

Example 12

Find the inverse of each of the following functions, stating the domain and range for each:

a $f: [-2, 1] \rightarrow \mathbb{R}, f(x) = 2x + 3$

b $g(x) = \frac{1}{5-x}, x > 5$

c $h(x) = x^2 - 2, x \geq 1$

Solution

a $f: [-2, 1] \rightarrow \mathbb{R}, f(x) = 2x + 3$

$$\text{ran } f^{-1} = \text{dom } f = [-2, 1]$$

$$\text{dom } f^{-1} = \text{ran } f = [-1, 5]$$

Let $y = 2x + 3$. Interchange x and y :

$$x = 2y + 3$$

$$x - 3 = 2y$$

$$y = \frac{x - 3}{2}$$

$$\therefore f^{-1}: [-1, 5] \rightarrow \mathbb{R}, f^{-1}(x) = \frac{x - 3}{2}$$

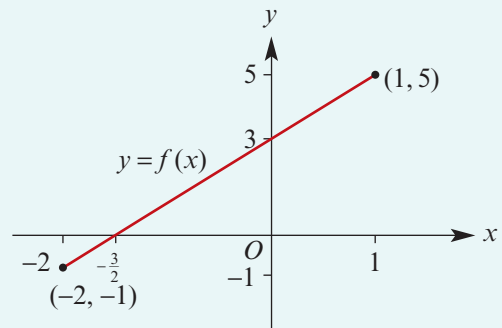

b $g(x) = \frac{1}{5-x}, x > 5$

$\text{ran } g^{-1} = \text{dom } g = (5, \infty)$

$\text{dom } g^{-1} = \text{ran } g = (-\infty, 0)$

Let $y = \frac{1}{5-x}$. Interchange x and y :

$$x = \frac{1}{5-y}$$

$$5-y = \frac{1}{x}$$

$$y = 5 - \frac{1}{x}$$

$\therefore g^{-1}: (-\infty, 0) \rightarrow \mathbb{R}, g^{-1}(x) = 5 - \frac{1}{x}$

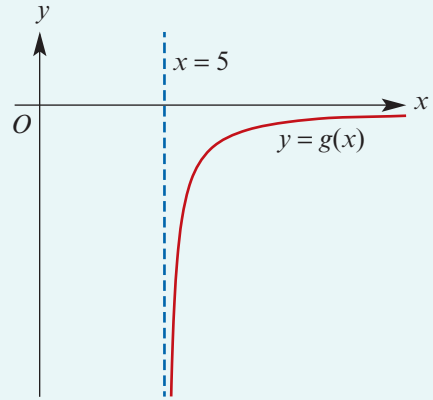

c $h(x) = x^2 - 2, x \geq 1$

$\text{ran } h^{-1} = \text{dom } h = [1, \infty)$

$\text{dom } h^{-1} = \text{ran } h = [-1, \infty)$

Let $y = x^2 - 2$. Interchange x and y :

$$x = y^2 - 2$$

$$y^2 = x + 2$$

$$y = \pm\sqrt{x+2}$$

$\therefore h^{-1}: [-1, \infty) \rightarrow \mathbb{R}, h^{-1}(x) = \sqrt{x+2}$

The positive square root is taken because of the known range.

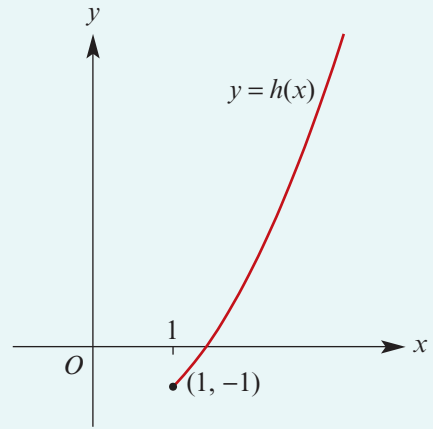

► Graphing inverse functions

The transformation which reflects each point in the plane in the line $y = x$ can be described as ‘interchanging the x - and y -coordinates of each point in the plane’ and can be written as $(x, y) \rightarrow (y, x)$. This is read as ‘the ordered pair (x, y) is mapped to the ordered pair (y, x) ’.

Reflecting the graph of a function in the line $y = x$ produces the graph of its **inverse relation**. Note that the image in the graph below is not a function.

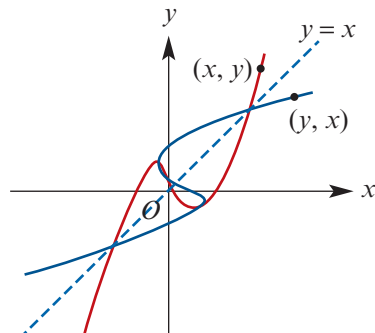
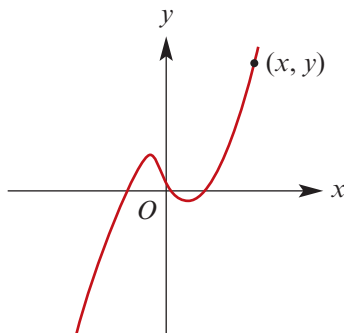

If the function is one-to-one, then the image is the graph of a function. (This is because, if the function satisfies the horizontal-line test, then its reflection will satisfy the vertical-line test.)



Example 13

Find the inverse of the function $f: \mathbb{R} \setminus \{0\} \rightarrow \mathbb{R}$, $f(x) = \frac{1}{x} + 3$ and sketch both functions on one set of axes, showing the points of intersection of the graphs.

Solution

We use method 2.

Let $x \in \text{dom } f^{-1} = \text{ran } f$. Then

$$\begin{aligned} f(f^{-1}(x)) &= x \\ \frac{1}{f^{-1}(x)} + 3 &= x \\ \frac{1}{f^{-1}(x)} &= x - 3 \\ \therefore f^{-1}(x) &= \frac{1}{x - 3} \end{aligned}$$

The inverse function is

$$f^{-1}: \mathbb{R} \setminus \{3\} \rightarrow \mathbb{R}, f^{-1}(x) = \frac{1}{x - 3}$$

The graphs of f and f^{-1} are shown opposite.

The two graphs intersect when

$$\begin{aligned} f(x) &= f^{-1}(x) \\ \frac{1}{x} + 3 &= \frac{1}{x - 3} \end{aligned}$$

$$3x^2 - 9x - 3 = 0$$

$$x^2 - 3x - 1 = 0$$

$$\therefore x = \frac{1}{2}(3 - \sqrt{13}) \text{ or } x = \frac{1}{2}(3 + \sqrt{13})$$

The points of intersection are

$$\left(\frac{1}{2}(3 - \sqrt{13}), \frac{1}{2}(3 - \sqrt{13})\right) \quad \text{and} \quad \left(\frac{1}{2}(3 + \sqrt{13}), \frac{1}{2}(3 + \sqrt{13})\right)$$

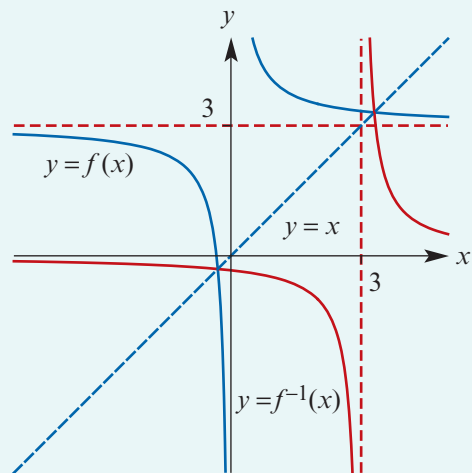

Note: In this example, the points of intersection of the graphs of $y = f(x)$ and $y = f^{-1}(x)$ can also be found by solving either $f(x) = x$ or $f^{-1}(x) = x$, rather than the more complicated equation $f(x) = f^{-1}(x)$.

However, there can be points of intersection of the graphs of $y = f(x)$ and $y = f^{-1}(x)$ that *do not* lie on the line $y = x$, as shown in the diagram opposite.

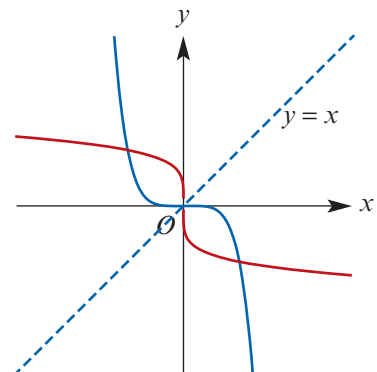

Example 14

Find the inverse of the function with rule $f(x) = 3\sqrt{x+2} + 4$ and sketch both functions on one set of axes.

Solution

Consider $x = 3\sqrt{y+2} + 4$ and solve for y :

$$\frac{x-4}{3} = \sqrt{y+2}$$

$$y = \left(\frac{x-4}{3}\right)^2 - 2$$

$$\therefore f^{-1}(x) = \left(\frac{x-4}{3}\right)^2 - 2$$

The domain of f^{-1} equals the range of f . Thus

$$f^{-1}: [4, \infty) \rightarrow \mathbb{R}, f^{-1}(x) = \left(\frac{x-4}{3}\right)^2 - 2$$

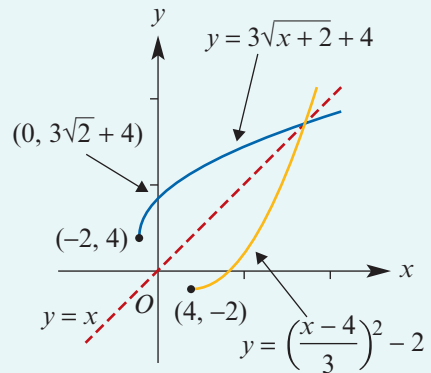
**Using the TI-Nspire**

- First find the rule for the inverse of $y = 3\sqrt{x+2} + 4$ by solving the equation $x = 3\sqrt{y+2} + 4$ for y .
- Insert a **Graphs** page and enter $f1(x) = 3\sqrt{x+2} + 4$, $f2(x) = \frac{x^2}{9} - \frac{8x}{9} - \frac{2}{9} \mid x \geq 4$ and $f3(x) = x$.

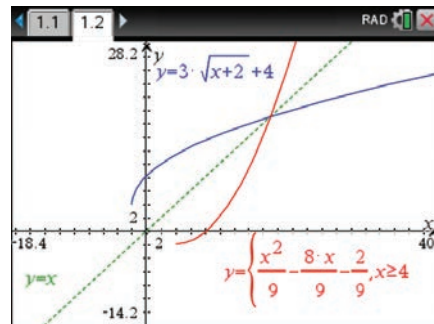
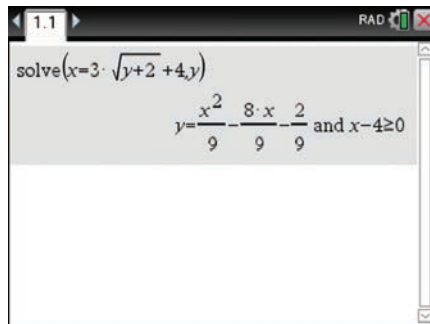

Note: To change the graph label to $y =$, place the cursor on the plot, press **(ctrl)** **(menu)** > **Attributes**, arrow down to the **Label Style** and select the desired style using the arrow keys. The **Attributes** menu can also be used to change the **Line Style**.



Using the Casio ClassPad

To find the rule for the inverse of $f(x) = 3\sqrt{x+2} + 4$:

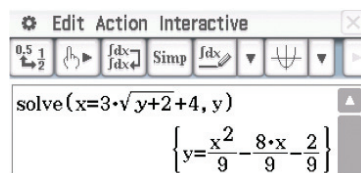
- In $\sqrt{\square}$, enter and highlight $x = 3\sqrt{y+2} + 4$.
- Select **Interactive** > **Equation/Inequality** > **solve** and set the variable as y . Then tap **OK**.



To graph the inverse of $f(x) = 3\sqrt{x+2} + 4$:

- In , enter the rule for the function f in y1.
- Tick the box and tap .
- Use  to adjust the window view.
- To graph the inverse function f^{-1} , select **Analysis** > **Sketch** > **Inverse**.

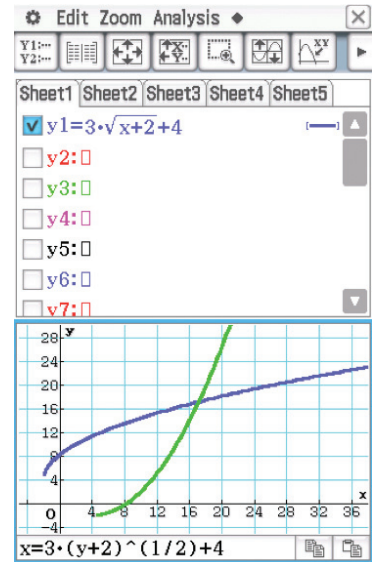

Example 15

Express $\frac{x+4}{x+1}$ in the form $\frac{a}{x+b} + c$. Hence find the inverse of the function $f(x) = \frac{x+4}{x+1}$.

Sketch both functions on the one set of axes.

Solution

$$\frac{x+4}{x+1} = \frac{3+x+1}{x+1} = \frac{3}{x+1} + \frac{x+1}{x+1} = \frac{3}{x+1} + 1$$

Consider $x = \frac{3}{y+1} + 1$ and solve for y :

$$x - 1 = \frac{3}{y+1}$$

$$y + 1 = \frac{3}{x - 1}$$

$$\therefore y = \frac{3}{x - 1} - 1$$

The range of f is $\mathbb{R} \setminus \{1\}$ and thus the inverse function is

$$f^{-1}: \mathbb{R} \setminus \{1\} \rightarrow \mathbb{R}, f^{-1}(x) = \frac{3}{x-1} - 1$$

Note: The graph of f^{-1} is obtained by reflecting the graph of f in the line $y = x$.

The two graphs meet where

$$\frac{3}{x+1} + 1 = x, \quad x \neq -1$$

i.e. where $x = \pm 2$. Thus the two graphs meet at the points $(2, 2)$ and $(-2, -2)$.

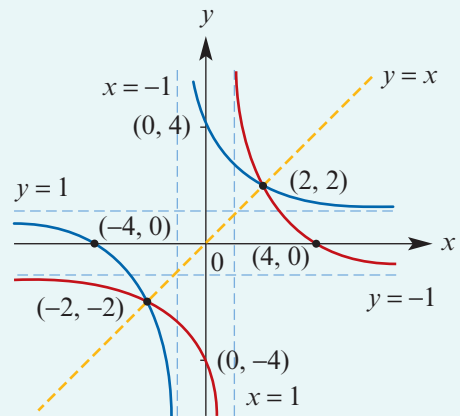

Example 16

Let f be the function given by $f(x) = \frac{1}{x^2}$ for $x \in \mathbb{R} \setminus \{0\}$. Define a suitable restriction g of f such that g^{-1} exists, and find g^{-1} .

Solution

The function f is not one-to-one. Therefore the inverse function f^{-1} is not defined. The following restrictions of f are one-to-one:

$$f_1: (0, \infty) \rightarrow \mathbb{R}, \quad f_1(x) = \frac{1}{x^2} \quad \text{Range of } f_1 = (0, \infty)$$

$$f_2: (-\infty, 0) \rightarrow \mathbb{R}, \quad f_2(x) = \frac{1}{x^2} \quad \text{Range of } f_2 = (0, \infty)$$

Let g be f_1 and determine f_1^{-1} .

Using method 2, we require f_1^{-1} such that

$$f_1(f_1^{-1}(x)) = x$$

$$\frac{1}{(f_1^{-1}(x))^2} = x$$

$$f_1^{-1}(x) = \pm \frac{1}{\sqrt{x}}$$

But $\text{ran } f_1^{-1} = \text{dom } f_1 = (0, \infty)$ and so

$$f_1^{-1}(x) = \frac{1}{\sqrt{x}}$$

As $\text{dom } f_1^{-1} = \text{ran } f_1 = (0, \infty)$, the inverse function is $f_1^{-1}: (0, \infty) \rightarrow \mathbb{R}, f_1^{-1}(x) = \frac{1}{\sqrt{x}}$

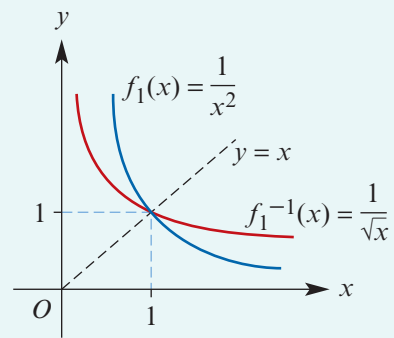
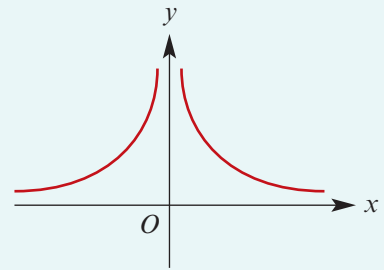

Summary of inverse functions

- If f is a one-to-one function, then a new function f^{-1} , called the **inverse** of f , may be defined by

$$f^{-1}(x) = y \text{ if } f(y) = x, \quad \text{for } x \in \text{ran } f, y \in \text{dom } f$$

- $\text{dom } f^{-1} = \text{ran } f$
- $\text{ran } f^{-1} = \text{dom } f$
- $f \circ f^{-1}(x) = x$, for all $x \in \text{dom } f^{-1}$
- $f^{-1} \circ f(x) = x$, for all $x \in \text{dom } f$
- The point (x, y) is on the graph of f^{-1} if and only if the point (y, x) is on the graph of f . Thus the graph of f^{-1} is the reflection of the graph of f in the line $y = x$.

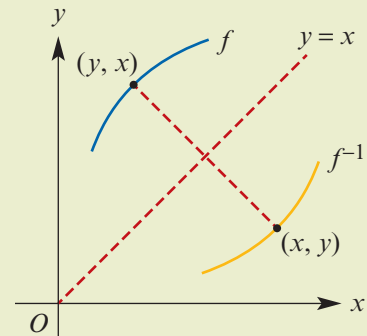

Exercise 2D

Skillsheet

1 Find the inverse function f^{-1} of the function:

Example 11

a $f(x) = 2x + 3$

b $f(x) = 4 - 3x$

c $f(x) = 4x + 3$

2 For each of the following, find the rule for the inverse:

a $f: \mathbb{R} \rightarrow \mathbb{R}, f(x) = x - 4$

b $f: \mathbb{R} \rightarrow \mathbb{R}, f(x) = 2x$

c $f: \mathbb{R} \rightarrow \mathbb{R}, f(x) = \frac{3x}{4}$

d $f: \mathbb{R} \rightarrow \mathbb{R}, f(x) = \frac{3x - 2}{4}$

Example 12

3 For each of the following functions, find the inverse and state its domain and range:

a $f: [-2, 6] \rightarrow \mathbb{R}, f(x) = 2x - 4$

b $g(x) = \frac{1}{9 - x}, x > 9$

c $h(x) = x^2 + 2, x \geq 0$

d $f: [-3, 6] \rightarrow \mathbb{R}, f(x) = 5x - 2$

e $g: (1, \infty) \rightarrow \mathbb{R}, g(x) = x^2 - 1$

f $h: \mathbb{R}^+ \rightarrow \mathbb{R}, h(x) = \sqrt{x}$

4 Consider the function $g: [-1, \infty) \rightarrow \mathbb{R}, g(x) = x^2 + 2x$.a Find g^{-1} , stating the domain and range.b Sketch the graph of g^{-1} .

Example 13

5 Find the inverse of the function $f: \mathbb{R} \setminus \{0\} \rightarrow \mathbb{R}, f(x) = \frac{1}{x} - 3$. Sketch both functions on one set of axes, showing the points of intersection of the graphs.6 Let $f: [0, 3] \rightarrow \mathbb{R}, f(x) = 3 - 2x$. Find $f^{-1}(2)$ and the domain of f^{-1} .

7 For each of the following functions, find the inverse and state its domain and range:

a $f: [-1, 3] \rightarrow \mathbb{R}, f(x) = 2x$

b $f: [0, \infty) \rightarrow \mathbb{R}, f(x) = 2x^2 - 4$

c $\{(1, 6), (2, 4), (3, 8), (5, 11)\}$

d $h: \mathbb{R}^- \rightarrow \mathbb{R}, h(x) = \sqrt{-x}$

e $f: \mathbb{R} \rightarrow \mathbb{R}, f(x) = x^3 + 1$

f $g: (-1, 3) \rightarrow \mathbb{R}, g(x) = (x + 1)^2$

g $g: [1, \infty) \rightarrow \mathbb{R}, g(x) = \sqrt{x - 1}$

h $h: [0, 2] \rightarrow \mathbb{R}, h(x) = \sqrt{4 - x^2}$

Example 14

8 For each of the following functions, sketch the graph of the function and on the same set of axes sketch the graph of the inverse function. For each of the functions, state the rule, domain and range of the inverse. It is advisable to draw in the line with equation $y = x$ for each set of axes.

a $y = 2x + 4$

b $f(x) = \frac{3 - x}{2}$

c $f: [2, \infty) \rightarrow \mathbb{R}, f(x) = (x - 2)^2$

d $f: [1, \infty) \rightarrow \mathbb{R}, f(x) = (x - 1)^2$

e $f: (-\infty, 2] \rightarrow \mathbb{R}, f(x) = (x - 2)^2$

f $f: \mathbb{R}^+ \rightarrow \mathbb{R}, f(x) = \frac{1}{x}$

g $f: \mathbb{R}^+ \rightarrow \mathbb{R}, f(x) = \frac{1}{x^2}$

h $h(x) = \frac{1}{2}(x - 4)$

- 9 Find the inverse function of each of the following, and sketch the graph of the inverse function:

a $f: \mathbb{R}^+ \cup \{0\} \rightarrow \mathbb{R}, f(x) = \sqrt{x} + 2$

b $f: \mathbb{R} \setminus \{3\} \rightarrow \mathbb{R}, f(x) = \frac{1}{x-3}$

c $f: [2, 8) \rightarrow \mathbb{R}, f(x) = \sqrt{x-2} + 4$

d $f: \mathbb{R} \setminus \{2\} \rightarrow \mathbb{R}, f(x) = \frac{3}{x-2} + 1$

e $f: \mathbb{R} \setminus \{1\} \rightarrow \mathbb{R}, f(x) = \frac{5}{x-1} - 1$

f $f: (-\infty, 2] \rightarrow \mathbb{R}, f(x) = \sqrt{2-x} + 1$

Example 15

- 10 Find the rule for the inverse of each of the following functions:

a $f: \mathbb{R} \setminus \{1\} \rightarrow \mathbb{R}, f(x) = \frac{x+1}{x-1}$

b $f: [2, \infty) \rightarrow \mathbb{R}, f(x) = \sqrt{x-2}$

c $f: \mathbb{R} \setminus \{\frac{2}{3}\} \rightarrow \mathbb{R}, f(x) = \frac{2x+3}{3x-2}$

- 11 Copy each of the following graphs and on the same set of axes draw the inverse of each of the corresponding functions:

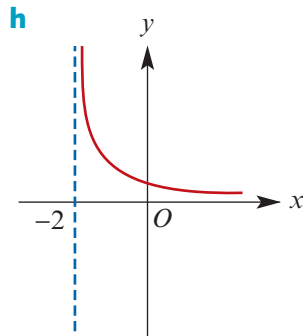
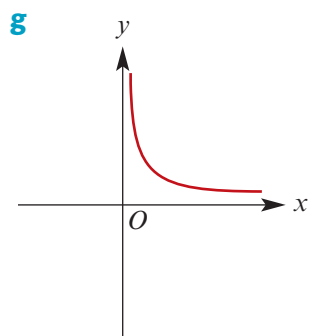
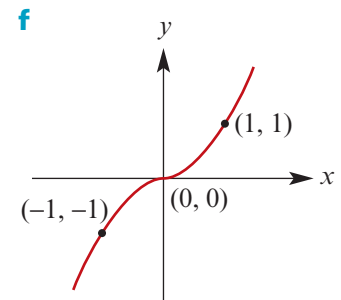
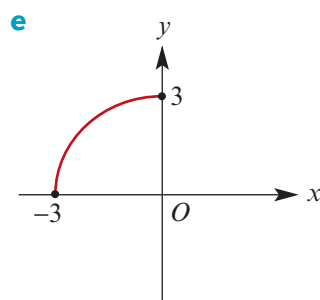
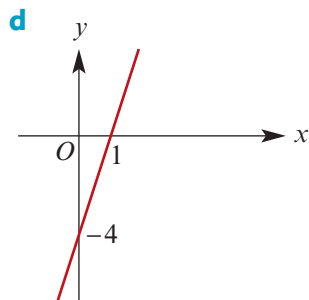
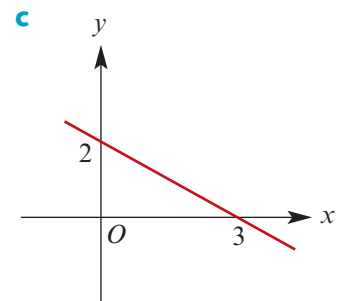
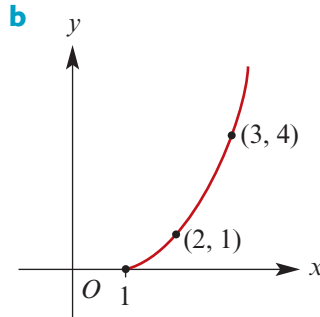
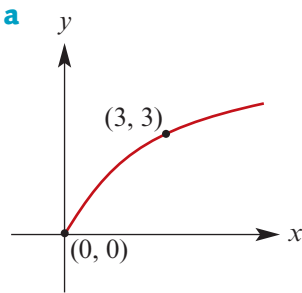

12 Match each of the graphs of **a**, **b**, **c** and **d** with its inverse.

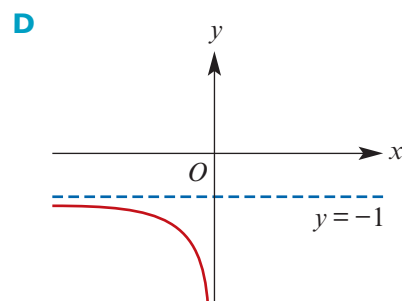
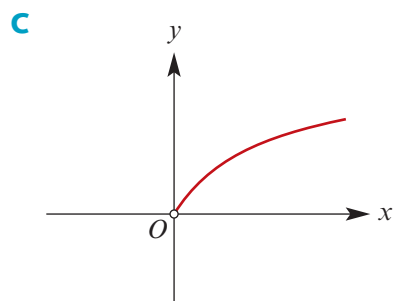
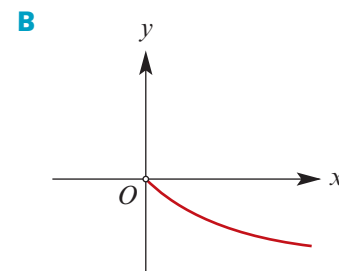
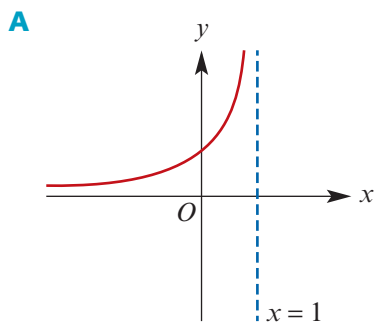
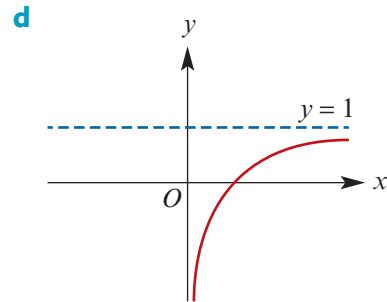
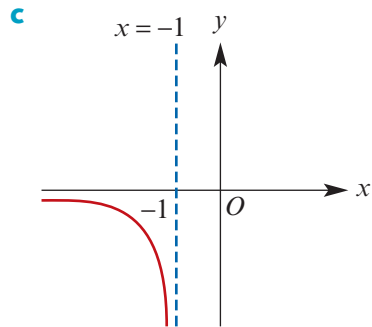
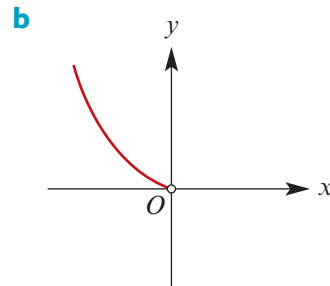
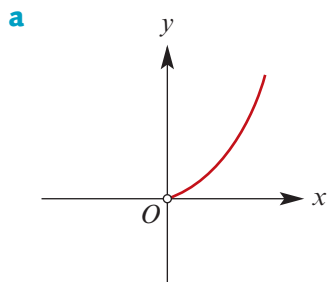

13 a Let $f: A \rightarrow \mathbb{R}$, $f(x) = \sqrt{3-x}$. If A is the set of all real values of x for which $f(x)$ is defined, find A .

Example 16

b Let $g: [b, 2] \rightarrow \mathbb{R}$, $g(x) = 1 - x^2$. If b is the smallest real number such that g has an inverse function, find b and $g^{-1}(x)$.

14 Let $g: [b, \infty) \rightarrow \mathbb{R}$, where $g(x) = x^2 + 4x$. If b is the smallest real number such that g has an inverse function, find b and $g^{-1}(x)$.

15 Let $f: (-\infty, a) \rightarrow \mathbb{R}$, where $f(x) = x^2 - 6x$. If a is the largest real number such that f has an inverse function, find a and $f^{-1}(x)$.

16 For each of the following functions, find the inverse function and state its domain:

a $g(x) = \frac{3}{x}$

b $g(x) = \sqrt[3]{x+2} - 4$

c $h(x) = 2 - \sqrt{x}$

d $f(x) = \frac{3}{x} + 1$

e $h(x) = 5 - \frac{2}{(x-6)^3}$

f $g(x) = \frac{1}{(x-1)^{\frac{3}{4}}} + 2$

17 For each of the following, copy the graph onto a grid and sketch the graph of the inverse on the same set of axes. In each case, state whether the inverse is or is not a function.

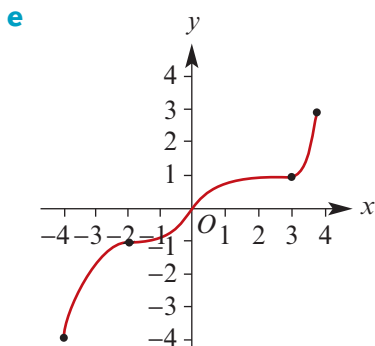
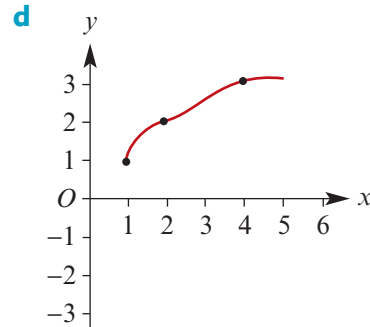
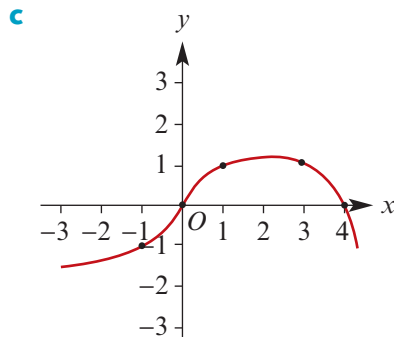
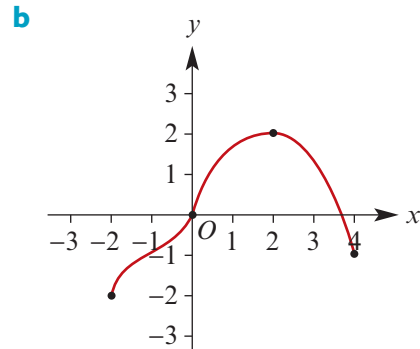
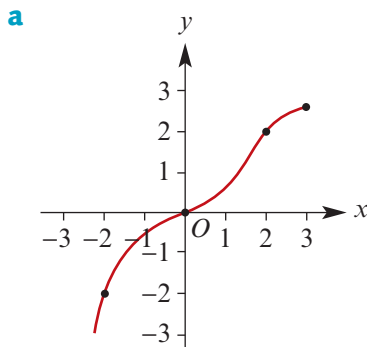

18 Let $f: S \rightarrow \mathbb{R}$ be given by $f(x) = \frac{x+3}{2x-1}$, where $S = \mathbb{R} \setminus \{\frac{1}{2}\}$.

a Show that $f \circ f$ is defined.

b Find $f \circ f(x)$ and sketch the graph of $f \circ f$.

c Write down the inverse of f .



2E Further composite and inverse functions

In this section, we consider further examples of composite and inverse functions. We use the natural exponential and logarithm functions $y = e^x$ and $y = \ln x$, which are introduced in Mathematical Methods Year 12. Therefore you may wish to wait until later in the course to complete this section.

Example 17

Let $f(x) = \sin x$ and $g(x) = |x|$.

- Find the rules for $f \circ g$ and $g \circ f$.
- Sketch the graphs of $y = f \circ g(x)$ and $y = g \circ f(x)$ for $x \in [-2\pi, 2\pi]$, and state the range of each of these composite functions.

Solution

$$\begin{aligned} \mathbf{a} \quad f \circ g(x) &= f(g(x)) \\ &= f(|x|) \\ &= \sin(|x|) \end{aligned}$$

$$\begin{aligned} g \circ f(x) &= g(f(x)) \\ &= g(\sin x) \\ &= |\sin x| \end{aligned}$$

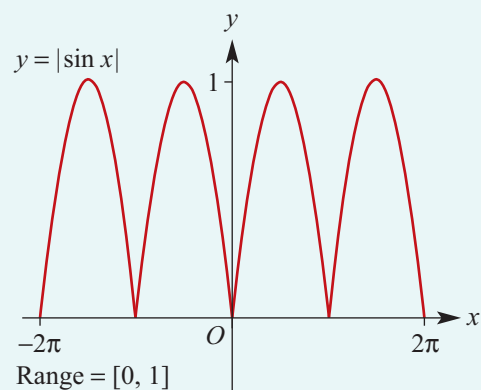
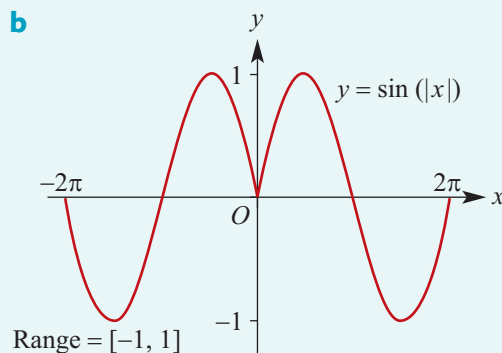

Example 18

Let $f(x) = \ln x$ and $g(x) = |x|$.

- State the maximal domain for g such that $f \circ g$ exists.
 - State the maximal domain for f such that $g \circ f$ exists.
- Find the rules for $f \circ g$ and $g \circ f$.
- Sketch the graphs of $y = f \circ g(x)$ and $y = g \circ f(x)$.

Solution

- For $f \circ g$ to exist, the range of g must be a subset of the domain of f . The maximal domain of f is \mathbb{R}^+ , so $f \circ g(x)$ is defined for $x \in \mathbb{R} \setminus \{0\}$. Hence the maximal domain of $f \circ g$ is $\mathbb{R} \setminus \{0\}$.
 - For $g \circ f$ to exist, the range of f must be a subset of the domain of g . The maximal domain of g is \mathbb{R} , so $g \circ f(x)$ is defined for $x \in \mathbb{R}^+$. Hence the maximal domain of $g \circ f$ is \mathbb{R}^+ .

b $f \circ g(x) = f(g(x)) = f(|x|) = \ln|x|$

$g \circ f(x) = g(f(x)) = g(\ln x) = |\ln x|$

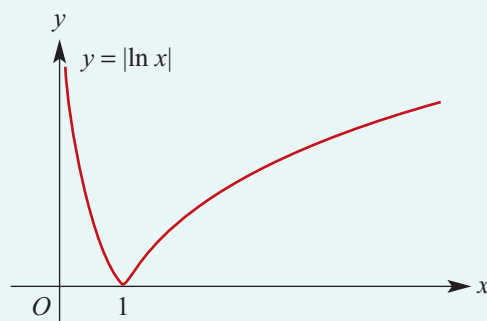
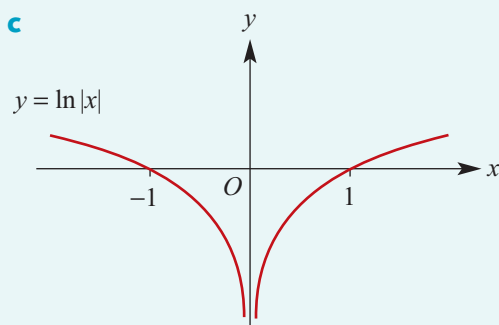

It can sometimes be helpful to express a given function as the composition of two simpler functions. This will be used for differentiation in Chapter 10.

Example 19

Express each of the following as the composition of two functions:

a $h(x) = e^{x^2}$

b $h(x) = \sin|x|$

c $h(x) = (x^2 - 2)^n, \quad n \in \mathbb{N}$

Solution

a $h(x) = e^{x^2}$

Choose $f(x) = x^2$
and $g(x) = e^x$.

Then $h(x) = g \circ f(x)$.

b $h(x) = \sin|x|$

Choose $f(x) = |x|$
and $g(x) = \sin x$.

Then $h(x) = g \circ f(x)$.

c $h(x) = (x^2 - 2)^n, \quad n \in \mathbb{N}$

Choose $f(x) = x^2 - 2$
and $g(x) = x^n$.

Then $h(x) = g \circ f(x)$.

Note: These are not the only possible answers, but the ‘natural’ choices have been made.

Example 20

Let $f(x) = e^{2x}$ and let $g(x) = \frac{1}{\sqrt{x}}$ for $x \in \mathbb{R}^+$. Find:

a f^{-1}

b g^{-1}

c $f \circ g$

d $g \circ f$

e $(f \circ g)^{-1}$

f $(g \circ f)^{-1}$

Solution

a $f^{-1}(x) = \frac{1}{2} \ln x, \quad x \in \mathbb{R}^+$

b $g^{-1}(x) = \frac{1}{x^2}, \quad x \in \mathbb{R}^+$

c $f \circ g(x) = f\left(\frac{1}{\sqrt{x}}\right) = e^{\frac{2}{\sqrt{x}}}, \quad x \in \mathbb{R}^+$

d $g \circ f(x) = g(e^{2x}) = \frac{1}{e^x}, \quad x \in \mathbb{R}$

e For $(f \circ g)^{-1}$, let $x = e^{\frac{2}{\sqrt{y}}}$. Then

$$\ln x = \frac{2}{\sqrt{y}}$$

$$\therefore y = \left(\frac{2}{\ln x}\right)^2$$

$$(f \circ g)^{-1}(x) = \left(\frac{2}{\ln x}\right)^2, \quad x \in (1, \infty)$$

f For $(g \circ f)^{-1}$, let $x = \frac{1}{e^y}$. Then

$$e^y = \frac{1}{x}$$

$$\therefore y = \ln\left(\frac{1}{x}\right) = -\ln x$$

$$(g \circ f)^{-1}(x) = -\ln x, \quad x \in \mathbb{R}^+$$

Exercise 2E

Skillsheet

1 Let $g(x) = |x|$. For each of the following functions f :

- i** Find the rules $f \circ g(x)$ and $g \circ f(x)$.
- ii** Find the range of $y = f \circ g(x)$ and $y = g \circ f(x)$ (and state the maximal domain for each of the composite functions to exist).
- | | |
|------------------------------|-------------------------------|
| a $f(x) = 3 \sin(2x)$ | b $f(x) = -2 \cos(2x)$ |
| c $f(x) = e^x$ | d $f(x) = e^{2x} - 1$ |
| e $f(x) = -2e^x - 1$ | f $f(x) = \ln(2x)$ |
| g $f(x) = \ln(x - 1)$ | h $f(x) = -\ln x$ |

Example 19

2 Express each of the following as the composition of two functions:

- | | |
|---|-------------------------------|
| a $h(x) = e^{x^3}$ | b $h(x) = \cos 2x $ |
| c $h(x) = (x^2 - 2x)^n$ where $n \in \mathbb{N}$ | d $h(x) = \cos(x^2)$ |
| e $h(x) = \cos^2 x$ | f $h(x) = (x^2 - 1)^4$ |
| g $h(x) = \ln(x^2)$ | h $h(x) = \cos(2x) $ |
| i $h(x) = (x^2 - 2x)^3 - 2(x^2 - 2x)$ | |

Example 20

3 Let $f(x) = 4e^{3x}$ and let $g(x) = \frac{2}{\sqrt[3]{x}}$ for $x \in \mathbb{R} \setminus \{0\}$. Find:

- | | | |
|----------------------|-----------------------------|-----------------------------|
| a f^{-1} | b g^{-1} | c $f \circ g$ |
| d $g \circ f$ | e $(f \circ g)^{-1}$ | f $(g \circ f)^{-1}$ |

4 The functions f and g are defined by $f: \mathbb{R} \rightarrow \mathbb{R}$, $f(x) = e^{4x}$ and $g: \mathbb{R}^+ \rightarrow \mathbb{R}$, $g(x) = 2\sqrt{x}$. Find each of the following:

- | | | |
|-------------------------|--------------------------------|------------------------------|
| a $g \circ f(x)$ | b $(g \circ f)^{-1}(x)$ | c $f \circ g^{-1}(x)$ |
|-------------------------|--------------------------------|------------------------------|

5 The functions f and g are defined by $f: \mathbb{R} \rightarrow \mathbb{R}$, $f(x) = e^{-2x}$ and $g: \mathbb{R} \rightarrow \mathbb{R}$, $g(x) = x^3 + 1$.

- a** Find the inverse function of each of these functions.
- b** Find the rules $f \circ g(x)$ and $g \circ f(x)$ and state the range of each of these composite functions.

6 The function f is defined by $f: (-1, \infty) \rightarrow \mathbb{R}$, $f(x) = \frac{1}{x+1}$.

- a** Find f^{-1} .
- b** Solve the equation $f(x) = f^{-1}(x)$ for x .

7 The functions f and g are defined by $f: (-1, \infty) \rightarrow \mathbb{R}$, $f(x) = \ln(x+1)$ and $g: (-1, \infty) \rightarrow \mathbb{R}$, $g(x) = x^2 + 2x$.

- a** Define f^{-1} and g^{-1} , giving their rules and domains.
- b** Find the rule for $f \circ g$.

- 8** The functions f and g are defined by $f: (0, \infty) \rightarrow \mathbb{R}$, $f(x) = \ln x$ and $g: (0, \infty) \rightarrow \mathbb{R}$, $g(x) = \frac{1}{x}$. Find $f \circ g(x)$ and simplify $f(x) + f \circ g(x)$.
- 9** The functions g and h are defined by $g: \mathbb{R} \rightarrow \mathbb{R}$, $g(x) = 5x^2 + 3$ and $h: [3, \infty) \rightarrow \mathbb{R}$, $h(x) = \sqrt{\frac{x-3}{5}}$. Find $h(g(x))$.
- 10** For $f(x) = 4 - x^2$, solve the equation $f(f(x)) = 0$ for x .
- 11** For $f(x) = e^x - e^{-x}$, show that:
- $f(-x) = -f(x)$
 - $[f(x)]^3 = f(3x) - 3f(x)$
- 12** The inverse function of the linear function $f(x) = ax + b$ is $f^{-1}(x) = 6x + 3$. Find the values of a and b .
- 13** Show that $f = f^{-1}$ for $f(x) = \frac{x+2}{x-1}$.
- 14** Let $g: \mathbb{R} \rightarrow \mathbb{R}$ such that $\ln(g(x)) = ax + b$. Given that $g(0) = 1$ and $g(1) = e^6$, find a and b and hence find $g(x)$.
- 15** **a** Let $f: [0, \infty) \rightarrow \mathbb{R}$, $f(x) = \frac{e^x + e^{-x}}{2}$. Find f^{-1} .
- b** Let $g: \mathbb{R} \rightarrow \mathbb{R}$, $g(x) = \frac{e^x - e^{-x}}{2}$. Find g^{-1} .
- 16** Let f and g be functions such that the composite $g \circ f$ is defined.
- Prove that, if both f and g are one-to-one, then $g \circ f$ is one-to-one.
 - Prove that, if $g \circ f$ is one-to-one, then f is one-to-one.
 - Give an example of a pair of functions $f: \mathbb{R} \rightarrow \mathbb{R}$ and $g: \mathbb{R} \rightarrow \mathbb{R}$ such that the composite $g \circ f$ is one-to-one, but g is not one-to-one.



Chapter summary



The modulus function

- The **modulus** or **absolute value** of a real number x is

$$|x| = \begin{cases} x & \text{if } x \geq 0 \\ -x & \text{if } x < 0 \end{cases}$$

For example: $|5| = 5$ and $|-5| = 5$.

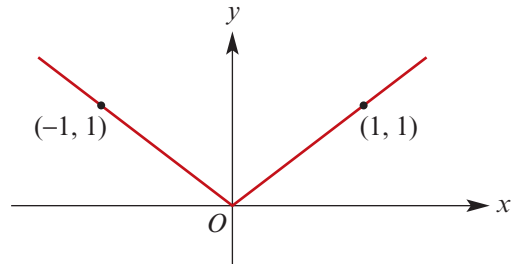

- On the number line, the distance between two numbers a and b is given by $|a - b| = |b - a|$. For example: $|x - 2| < 5$ can be read as ‘the distance of x from 2 is less than 5’.

Composition of functions

- The **composition** of function f followed by function g is denoted by $g \circ f$. The rule is given by

$$g \circ f(x) = g(f(x))$$

The domain of $g \circ f$ is the domain of f . The composition $g \circ f$ is defined only if the range of f is a subset of the domain of g .

Inverse functions

- A function f is said to be **one-to-one** if $a \neq b$ implies $f(a) \neq f(b)$, for all $a, b \in \text{dom } f$.
- If f is a one-to-one function, then a new function f^{-1} , called the **inverse** of f , may be defined by

$$f^{-1}(x) = y \text{ if } f(y) = x, \text{ for } x \in \text{ran } f, y \in \text{dom } f$$

- For a one-to-one function f and its inverse f^{-1} :
 - $\text{dom } f^{-1} = \text{ran } f$
 - $\text{ran } f^{-1} = \text{dom } f$
 - $f \circ f^{-1}(x) = x$, for all $x \in \text{dom } f^{-1}$
 - $f^{-1} \circ f(x) = x$, for all $x \in \text{dom } f$
 - The graph of f^{-1} is the reflection of the graph of f in the line $y = x$.

Short-answer questions

- 1 State the value of each of the following without using the absolute value function in your answer:

a $|-9|$ **b** $\left|-\frac{1}{400}\right|$ **c** $|9 - 5|$ **d** $|5 - 9|$ **e** $|\pi - 3|$ **f** $|\pi - 4|$

- 2 **a** Let $f: \{x : |x| > 100\} \rightarrow \mathbb{R}$, $f(x) = \frac{1}{x^2}$. State the range of f .
- b** Let $f: \{x : |x| < 0.1\} \rightarrow \mathbb{R}$, $f(x) = \frac{1}{x^2}$. State the range of f .

- 3** Let $f(x) = |x^2 - 3x|$. Solve the equation $f(x) = x$.
- 4** For each of the following, sketch the graph of $y = f(x)$ and state the range of f :
- a** $f: [0, 2\pi] \rightarrow \mathbb{R}, f(x) = 2|\sin x|$ **b** $f: \mathbb{R} \rightarrow \mathbb{R}, f(x) = |x^2 - 4x| - 3$
c $f: \mathbb{R} \rightarrow \mathbb{R}, f(x) = 3 - |x^2 - 4x|$
- 5** For $f(x) = 2x - 3$, find:
- a** $\{x : f(x) = 7\}$ **b** $\{x : f^{-1}(x) = 7\}$ **c** $\left\{x : \frac{1}{f(x)} = 7\right\}$
- 6** For $f: [3, \infty) \rightarrow \mathbb{R}, f(x) = x^2 - 1$, find f^{-1} .
- 7** Let $f: (-\infty, 2] \rightarrow \mathbb{R}, f(x) = 3x - 4$. On the one set of axes, sketch the graphs of $y = f(x)$ and $y = f^{-1}(x)$.
- 8** Find the inverse of each of the following functions:
- a** $f: \mathbb{R} \rightarrow \mathbb{R}, f(x) = 8x^3$ **b** $f: (-\infty, 0] \rightarrow \mathbb{R}, f(x) = 32x^5$
c $f: [0, \infty) \rightarrow \mathbb{R}, f(x) = 64x^6$ **d** $f: (1, \infty) \rightarrow \mathbb{R}, f(x) = 10\,000x^4$
- 9** For $f(x) = (x + 3)^2$ and $g(x) = 2 - x^3$, find:
- a** $f \circ g(x)$ **b** $g \circ f(x)$ **c** $g \circ g(x)$ **d** $f \circ f(x)$
- 10** If the function f has rule $f(x) = \sqrt{x^2 - 9}$ and the function g has rule $g(x) = x^3 - 1$, find the largest domain for g such that $f \circ g$ is defined.
- 11** For the function h with rule $h(x) = 2x^5 + 64$, find the rule for the inverse function h^{-1} .
- 12** Find the inverse of the function with the rule $f(x) = \sqrt{x - 2} + 4$ and sketch both functions on the one set of axes.
- 13** Find the inverse of the function with the rule $f(x) = \frac{x - 2}{x + 1}$.
- 14** Let $g(x) = \cos x$. For each of the following, write down a rule for the function f :
- a** $f \circ g(x) = \sqrt{1 + \cos x}$ **b** $f \circ g(x) = \cos^2 x - \cos x$
c $f \circ g(x) = 3 \cos^3 x + 2 \sin^2 x - \cos x$



Multiple-choice questions



- 1** The graph of the function with rule $y = |x|$ is reflected in the x -axis and then translated 4 units in the negative direction of the x -axis and 3 units in the negative direction of the y -axis. The rule for the new function is
- A** $y = |-x + 4| - 3$ **B** $y = -|x - 4| + 3$ **C** $y = -|x - 3| + 4$
D $y = |-x - 4| + 3$ **E** $y = -|x + 4| - 3$
- 2** The range of the function with rule $y = -3|\sin(2x)| + 3$ is
- A** $[0, 3]$ **B** $[0, 6]$ **C** $[-3, 3]$ **D** $[0, 6]$ **E** $[-3, 6]$

- 3** For $f(x) = 2 - \frac{1}{x}$ and $g(x) = \frac{1}{x+1}$, the composite function $f \circ g$ has the rule
- A** $f \circ g(x) = 1 - x$ **B** $f \circ g(x) = x + 1$ **C** $f \circ g(x) = 3 - x$
D $f \circ g(x) = \frac{2x+1}{x+1}$ **E** $f \circ g(x) = \frac{2x-1}{3x-1}$
- 4** For $f(x) = 2x - 3$, $f^{-1}(x) =$
- A** $2x + 3$ **B** $\frac{1}{2}x + 3$ **C** $\frac{1}{2}x + \frac{3}{2}$ **D** $\frac{1}{2x-3}$ **E** $\frac{1}{2}x - 3$
- 5** Which one of the following sets is a possible domain for the function with rule $f(x) = (x+3)^2 - 6$ if the inverse function is to exist?
- A** \mathbb{R} **B** $[-6, \infty)$ **C** $(-\infty, 3]$ **D** $[6, \infty)$ **E** $(-\infty, 0)$
- 6** For which one of the following functions does an inverse function not exist?
- A** $f: \mathbb{R} \rightarrow \mathbb{R}, f(x) = 2x - 4$ **B** $g: [-4, 4] \rightarrow \mathbb{R}, g(x) = \sqrt{16 - x^2}$
C $h: [0, \infty) \rightarrow \mathbb{R}, h(x) = -\frac{1}{5}x^2$ **D** $p: \mathbb{R}^+ \rightarrow \mathbb{R}, p(x) = \frac{1}{x^2}$
E $q: \mathbb{R} \rightarrow \mathbb{R}, q(x) = 2x^3 - 5$
- 7** The graph of the function f is shown on the right.

Which one of the following is most likely to be the graph of the inverse function of f ?

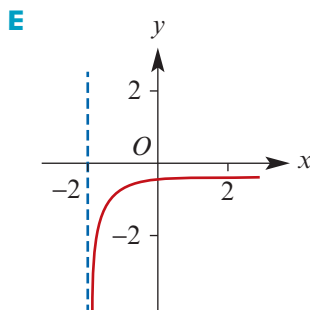
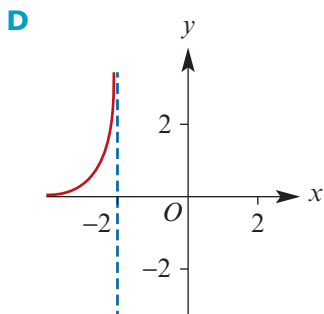
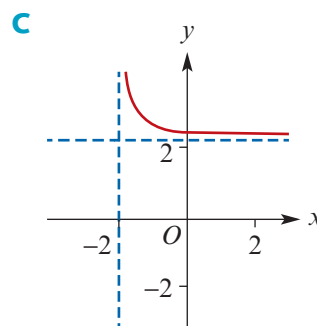
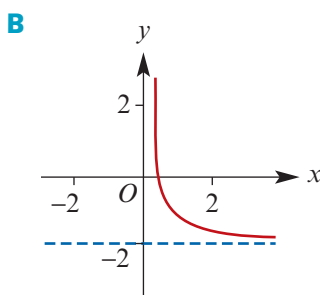
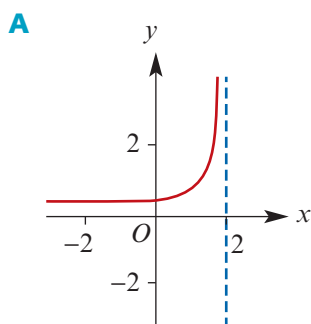
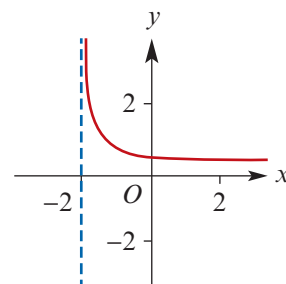

- 8** If $f: (2, \infty) \rightarrow \mathbb{R}$, $f(x) = \sqrt{2x+3}$, then the inverse function is
- A** $f^{-1}: (\sqrt{7}, \infty) \rightarrow \mathbb{R}$, $f^{-1}(x) = \frac{x^2-3}{2}$ **B** $f^{-1}: (7, \infty) \rightarrow \mathbb{R}$, $f^{-1}(x) = \sqrt{\frac{x}{2}-3}$
- C** $f^{-1}: (\sqrt{7}, \infty) \rightarrow \mathbb{R}$, $f^{-1}(x) = \frac{x^2+3}{2}$ **D** $f^{-1}: (7, \infty) \rightarrow \mathbb{R}$, $f^{-1}(x) = \frac{x^2-3}{2}$
- E** $f^{-1}: (2, \infty) \rightarrow \mathbb{R}$, $f^{-1}(x) = \frac{x^2-2}{3}$
- 9** For $g: \mathbb{R} \setminus \{3\} \rightarrow \mathbb{R}$, $g(x) = \frac{1}{x-3} + 2$, the domain and range of g^{-1} are
- A** $\text{dom } g^{-1} = \mathbb{R} \setminus \{2\}$, $\text{ran } g^{-1} = \mathbb{R} \setminus \{3\}$ **B** $\text{dom } g^{-1} = \mathbb{R} \setminus \{-2\}$, $\text{ran } g^{-1} = \mathbb{R} \setminus \{3\}$
- C** $\text{dom } g^{-1} = \mathbb{R} \setminus \{3\}$, $\text{ran } g^{-1} = \mathbb{R} \setminus \{2\}$ **D** $\text{dom } g^{-1} = \mathbb{R} \setminus \{3\}$, $\text{ran } g^{-1} = \mathbb{R} \setminus \{-2\}$
- E** $\text{dom } g^{-1} = \mathbb{R} \setminus \{-3\}$, $\text{ran } g^{-1} = \mathbb{R} \setminus \{2\}$
- 10** Let $g(x) = \frac{3}{(x+1)^3} - 2$. The equations of the asymptotes of the inverse function g^{-1} are
- A** $x = -2$, $y = 1$ **B** $x = -2$, $y = -1$ **C** $x = 1$, $y = -2$
- D** $x = -1$, $y = -2$ **E** $x = 2$, $y = -1$
- 11** Which one of the following functions does not have an inverse function?
- A** $f: [0, \infty) \rightarrow \mathbb{R}$, $f(x) = (x-2)^2$ **B** $f: \mathbb{R} \rightarrow \mathbb{R}$, $f(x) = x^3$
- C** $f: [-3, 3] \rightarrow \mathbb{R}$, $f(x) = \sqrt{9-x}$ **D** $f: \mathbb{R} \rightarrow \mathbb{R}$, $f(x) = x^{\frac{1}{3}} + 4$
- E** $f: \mathbb{R} \rightarrow \mathbb{R}$, $f(x) = 3x + 7$
- 12** Let $f: [0, 5] \rightarrow \mathbb{R}$, $f(x) = x^2$. For the rule $g(x) = |x-1| + 2$, the maximal domain of g such that the composite function $f \circ g$ is defined is
- A** $[-1, 4]$ **B** $[-1, 6]$ **C** $[-2, 4]$ **D** $[1, 4]$ **E** $[0, 5]$
- 13** For a one-to-one function g , if $f(g(x)) = 2x$, for all $x \in \text{dom } g$, then the inverse of g is given by
- A** $g^{-1}(x) = 2f(x)$ **B** $g^{-1}(x) = \frac{1}{2}f(x)$ **C** $g^{-1}(x) = \frac{1}{2}f^{-1}(x)$
- D** $g^{-1}(x) = \frac{1}{2}x$ **E** $g^{-1}(x) = 2x$



Extended-response questions

- 1** Consider the function with rule $f(x) = |x^2 - ax|$, where a is a positive constant.
- State the coordinates of the x -axis intercepts.
 - State the coordinates of the y -axis intercept.
 - Find the maximum value of the function in the interval $[0, a]$.
 - Find the possible values of a for which the point $(-1, 4)$ lies on the graph of $y = f(x)$.

- 2** Let $f: \mathbb{R} \rightarrow \mathbb{R}$ and $g: \mathbb{R} \rightarrow \mathbb{R}$, where $f(x) = x + 1$ and $g(x) = 2 + x^3$.
- State why $g \circ f$ exists and find $g \circ f(x)$.
 - State why $(g \circ f)^{-1}$ exists and find $(g \circ f)^{-1}(10)$.
- 3** Consider the function $f: D \rightarrow \mathbb{R}$ with rule $f(x) = \frac{24}{x+2} - 6$, where D is the maximal domain for this rule.
- Find D .
 - Describe a sequence of transformations which, when applied to the graph of $y = \frac{1}{x}$, produces the graph of $y = f(x)$. Specify the order in which these transformations are to be applied.
 - Find the coordinates of the points where the graph of f cuts the axes.
- Let $g: (-2, \infty) \rightarrow \mathbb{R}$, $g(x) = f(x)$.
- Find the rule for g^{-1} , the inverse of g .
 - Write down the domain of g^{-1} .
 - Sketch the graphs of $y = g(x)$ and $y = g^{-1}(x)$ on the one set of axes.
 - Find the value(s) of x for which $g(x) = x$ and hence the value(s) of x for which $g(x) = g^{-1}(x)$.
- 4** Consider the function $f: D \rightarrow \mathbb{R}$ with rule $f(x) = 4 - 2\sqrt{2x+6}$, where D is the maximal domain for this rule.
- Find D .
 - Describe a sequence of transformations which, when applied to the graph of $y = \sqrt{x}$, produces the graph of $y = f(x)$. Specify the order in which these transformations are to be applied.
 - Find the coordinates of the points where the graph of f cuts the axes.
 - Find the rule for f^{-1} , the inverse of f .
 - Find the domain of f^{-1} .
 - Sketch the graphs of $y = f(x)$ and $y = f^{-1}(x)$ on the one set of axes.
 - Find the value(s) of x for which $f(x) = x$ and hence the value(s) of x for which $f(x) = f^{-1}(x)$.
- 5** Consider the function $g: D \rightarrow \mathbb{R}$ with rule $g(x) = \frac{3}{(3x-4)^2} + 6$, where D is the maximal domain for this rule.
- Find D .
 - Find the smallest value of a such that $f: (a, \infty) \rightarrow \mathbb{R}$, $f(x) = g(x)$ is a one-to-one function.
 - Find the inverse function of f .
 - Find the value of x for which $f(x) = f^{-1}(x)$.
 - On the one set of axes, sketch the graphs of $y = f(x)$ and $y = f^{-1}(x)$.

- 6 a** Sketch the curve with equation $f(x) = \frac{50}{20-x}$, for $x \neq 20$.
- b** For $g(x) = \frac{50x}{20-x}$:
- Show that $g(x) = \frac{1000}{20-x} - 50$.
 - Sketch the graph of $y = g(x)$.
 - Show that $g(x) = 20f(x) - 50$.
- c** Find the rule for the function g^{-1} .
- 7** Let $f: \mathbb{R} \setminus \left\{ \frac{-d}{c} \right\} \rightarrow \mathbb{R}$, $f(x) = \frac{ax+b}{cx+d}$.
- a** Find the inverse function f^{-1} .
- b** Find the inverse function when:
- $a = 3, b = 2, c = 3, d = 1$
 - $a = 3, b = 2, c = 2, d = -3$
 - $a = 1, b = -1, c = -1, d = -1$
 - $a = -1, b = 1, c = 1, d = 1$
- c** Determine the possible values of a, b, c and d if $f = f^{-1}$.
- 8** The transformation with rule $(x, y) \rightarrow (y, x)$ is the reflection in the line $y = x$. When this transformation is applied to the graph of a one-to-one function f , the image is the graph of the inverse function f^{-1} .
- a** For the graph of $y = f(x)$, find the rule for the image of f , in terms of $f^{-1}(x)$, for each of the following sequences of transformations:
- a translation of 3 units in the positive direction of the x -axis
 - a translation of 5 units in the positive direction of the y -axis
 - a reflection in the line $y = x$
 - a reflection in the line $y = x$
 - a translation of 3 units in the positive direction of the x -axis
 - a translation of 5 units in the positive direction of the y -axis
 - a dilation of factor 3 from the x -axis
 - a dilation of factor 5 from the y -axis
 - a reflection in the line $y = x$
 - a reflection in the line $y = x$
 - a dilation of factor 5 from the y -axis
 - a dilation of factor 3 from the x -axis.
- b** Find the image of the graph of $y = f(x)$, in terms of $f^{-1}(x)$, under the transformation with rule $(x, y) \rightarrow (ay + b, cx + d)$, where a, b, c and d are positive constants, and describe this transformation in words.



3

Circular functions

Objectives

- ▶ To understand the **reciprocal circular functions** cosecant, secant and cotangent.
- ▶ To understand and apply the identities $\sec^2 \theta = 1 + \tan^2 \theta$ and $\operatorname{cosec}^2 \theta = 1 + \cot^2 \theta$.
- ▶ To apply the **compound angle formulas**.
- ▶ To apply the **double angle formulas**.
- ▶ To understand the **restricted circular functions** and their inverses \sin^{-1} , \cos^{-1} and \tan^{-1} .
- ▶ To understand the graphs of the **inverse circular functions** \sin^{-1} , \cos^{-1} and \tan^{-1} .
- ▶ To solve equations involving circular functions.

There are many interesting and useful relationships between the trigonometric functions. The most fundamental is the Pythagorean identity:

$$\sin^2 A + \cos^2 A = 1$$

Astronomy was the original motivation for these identities, many of which were discovered a very long time ago.

For example, the following two results were discovered by the Indian mathematician Bhāskara II in the twelfth century:

$$\sin(A + B) = \sin A \cos B + \cos A \sin B$$

$$\cos(A + B) = \cos A \cos B - \sin A \sin B$$

They are of great importance in many areas of mathematics, including calculus.

The sine, cosine and tangent functions are discussed in some detail in Section 1A. Several new circular functions are introduced in this chapter.

3A The reciprocal circular functions

► The cosecant function: $y = \operatorname{cosec} \theta$

The cosecant function is defined by

$$\operatorname{cosec} \theta = \frac{1}{\sin \theta}$$

provided $\sin \theta \neq 0$.

The graphs of $y = \operatorname{cosec} \theta$ and $y = \sin \theta$ are shown here on the same set of axes.

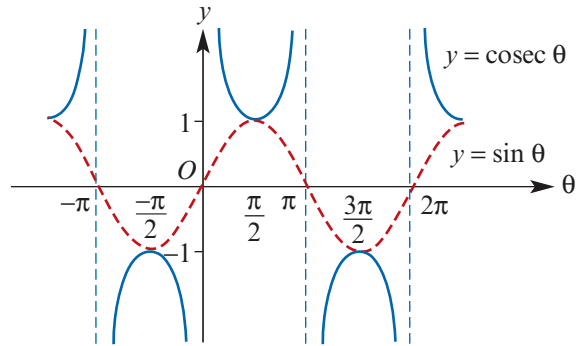

- **Domain** As $\sin \theta = 0$ when $\theta = n\pi$, $n \in \mathbb{Z}$, the domain of $y = \operatorname{cosec} \theta$ is $\mathbb{R} \setminus \{n\pi : n \in \mathbb{Z}\}$.
- **Range** The range of $y = \sin \theta$ is $[-1, 1]$, so the range of $y = \operatorname{cosec} \theta$ is $\mathbb{R} \setminus (-1, 1)$.
- **Turning points** The graph of $y = \sin \theta$ has turning points at $\theta = \frac{(2n+1)\pi}{2}$, for $n \in \mathbb{Z}$, as does the graph of $y = \operatorname{cosec} \theta$.
- **Asymptotes** The graph of $y = \operatorname{cosec} \theta$ has vertical asymptotes with equations $\theta = n\pi$, for $n \in \mathbb{Z}$.

► The secant function: $y = \sec \theta$

The secant function is defined by

$$\sec \theta = \frac{1}{\cos \theta}$$

provided $\cos \theta \neq 0$.

The graphs of $y = \sec \theta$ and $y = \cos \theta$ are shown here on the same set of axes.

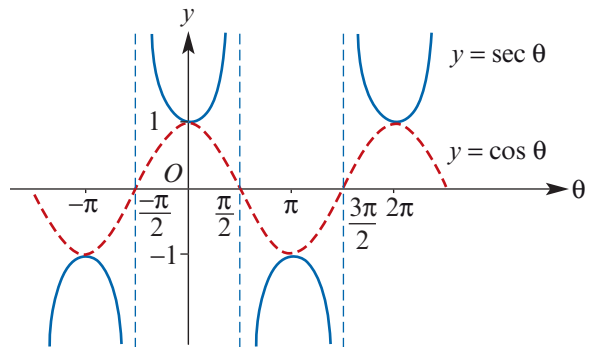

- **Domain** The domain of $y = \sec \theta$ is $\mathbb{R} \setminus \left\{ \frac{(2n+1)\pi}{2} : n \in \mathbb{Z} \right\}$.
- **Range** The range of $y = \sec \theta$ is $\mathbb{R} \setminus (-1, 1)$.
- **Turning points** The graph of $y = \sec \theta$ has turning points at $\theta = n\pi$, for $n \in \mathbb{Z}$.
- **Asymptotes** The vertical asymptotes have equations $\theta = \frac{(2n+1)\pi}{2}$, for $n \in \mathbb{Z}$.

Since the graph of $y = \cos \theta$ is a translation of the graph of $y = \sin \theta$, the graph of $y = \sec \theta$ is a translation of the graph of $y = \operatorname{cosec} \theta$, by $\frac{\pi}{2}$ units in the negative direction of the θ -axis.

► The cotangent function: $y = \cot \theta$

The cotangent function is defined by

$$\cot \theta = \frac{\cos \theta}{\sin \theta}$$

provided $\sin \theta \neq 0$.

Using the complementary properties of sine and cosine, we have

$$\begin{aligned} \cot \theta &= \tan\left(\frac{\pi}{2} - \theta\right) \\ &= -\tan\left(\pi - \left(\frac{\pi}{2} - \theta\right)\right) \\ &= -\tan\left(\theta + \frac{\pi}{2}\right) \end{aligned}$$

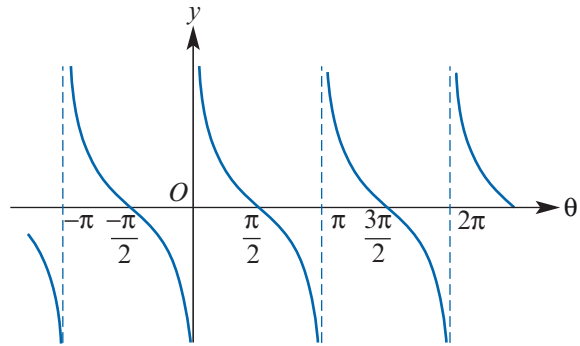

Therefore the graph of $y = \cot \theta$, shown above, is obtained from the graph of $y = \tan \theta$ by a translation of $\frac{\pi}{2}$ units in the negative direction of the θ -axis and then a reflection in the θ -axis.

- **Domain** As $\sin \theta = 0$ when $\theta = n\pi$, $n \in \mathbb{Z}$, the domain of $y = \cot \theta$ is $\mathbb{R} \setminus \{n\pi : n \in \mathbb{Z}\}$.
- **Range** The range of $y = \cot \theta$ is \mathbb{R} .
- **Asymptotes** The vertical asymptotes have equations $\theta = n\pi$, for $n \in \mathbb{Z}$.

Note: $\cot \theta = \frac{1}{\tan \theta}$ provided $\cos \theta \neq 0$

Example 1

Sketch the graph of each of the following over the interval $[0, 2\pi]$:

a $y = \operatorname{cosec}(2x)$

b $y = \sec\left(x + \frac{\pi}{3}\right)$

c $y = \cot\left(x - \frac{\pi}{4}\right)$

Solution

a The graph of $y = \operatorname{cosec}(2x)$ is obtained from the graph of $y = \operatorname{cosec} x$ by a dilation of factor $\frac{1}{2}$ from the y -axis.

The graph of $y = \sin(2x)$ is also shown.

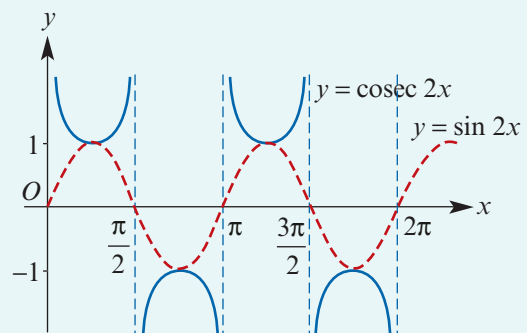

b The graph of $y = \sec\left(x + \frac{\pi}{3}\right)$ is obtained from the graph of $y = \sec x$ by a translation of $\frac{\pi}{3}$ units in the negative direction of the x -axis.

The y -axis intercept is $\sec\left(\frac{\pi}{3}\right) = 2$.

The asymptotes are $x = \frac{\pi}{6}$ and $x = \frac{7\pi}{6}$.

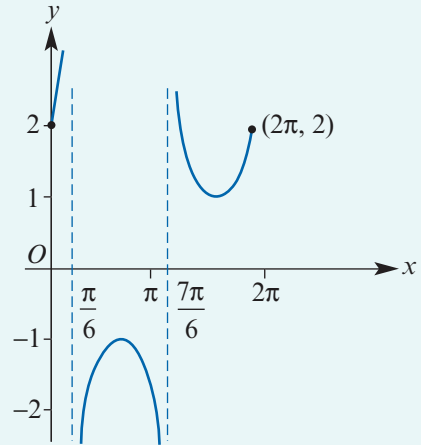

c The graph of $y = \cot\left(x - \frac{\pi}{4}\right)$ is obtained from the graph of $y = \cot x$ by a translation of $\frac{\pi}{4}$ units in the positive direction of the x -axis.

The y -axis intercept is $\cot\left(-\frac{\pi}{4}\right) = -1$.

The asymptotes are $x = \frac{\pi}{4}$ and $x = \frac{5\pi}{4}$.

The x -axis intercepts are $\frac{3\pi}{4}$ and $\frac{7\pi}{4}$.

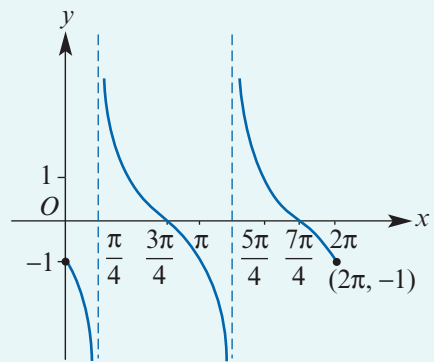

For right-angled triangles, the reciprocal functions can be defined through ratios:

$$\operatorname{cosec}(x^\circ) = \frac{\text{hyp}}{\text{opp}} \quad \sec(x^\circ) = \frac{\text{hyp}}{\text{adj}} \quad \cot(x^\circ) = \frac{\text{adj}}{\text{opp}}$$

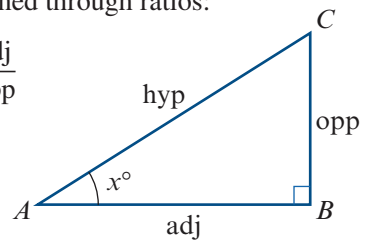

Example 2

In triangle ABC , $\angle ABC = 90^\circ$, $\angle CAB = x^\circ$, $AB = 6$ cm and $BC = 5$ cm. Find:

- AC
- the trigonometric ratios related to x°

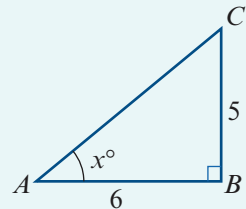

Solution

- By Pythagoras' theorem,

$$AC^2 = 5^2 + 6^2 = 61$$

$$\therefore AC = \sqrt{61} \text{ cm}$$
- $$\sin(x^\circ) = \frac{5}{\sqrt{61}} \quad \cos(x^\circ) = \frac{6}{\sqrt{61}} \quad \tan(x^\circ) = \frac{5}{6}$$

$$\operatorname{cosec}(x^\circ) = \frac{\sqrt{61}}{5} \quad \sec(x^\circ) = \frac{\sqrt{61}}{6} \quad \cot(x^\circ) = \frac{6}{5}$$

► Useful properties

The symmetry properties established for sine, cosine and tangent can be used to establish the following results:

$$\begin{array}{lll}
 \sec(\pi - x) = -\sec x & \operatorname{cosec}(\pi - x) = \operatorname{cosec} x & \cot(\pi - x) = -\cot x \\
 \sec(\pi + x) = -\sec x & \operatorname{cosec}(\pi + x) = -\operatorname{cosec} x & \cot(\pi + x) = \cot x \\
 \sec(2\pi - x) = \sec x & \operatorname{cosec}(2\pi - x) = -\operatorname{cosec} x & \cot(2\pi - x) = -\cot x \\
 \sec(-x) = \sec x & \operatorname{cosec}(-x) = -\operatorname{cosec} x & \cot(-x) = -\cot x
 \end{array}$$

The complementary properties are also useful:

$$\begin{array}{ll}
 \sec\left(\frac{\pi}{2} - x\right) = \operatorname{cosec} x & \operatorname{cosec}\left(\frac{\pi}{2} - x\right) = \sec x \\
 \cot\left(\frac{\pi}{2} - x\right) = \tan x & \tan\left(\frac{\pi}{2} - x\right) = \cot x
 \end{array}$$

Example 3

Find the exact value of each of the following:

a $\sec\left(\frac{11\pi}{4}\right)$

b $\operatorname{cosec}\left(-\frac{23\pi}{4}\right)$

c $\cot\left(\frac{11\pi}{3}\right)$

Solution

$$\begin{aligned}
 \mathbf{a} \quad \sec\left(\frac{11\pi}{4}\right) &= \sec\left(2\pi + \frac{3\pi}{4}\right) \\
 &= \sec\left(\frac{3\pi}{4}\right) \\
 &= \frac{1}{\cos\left(\frac{3\pi}{4}\right)} \\
 &= \frac{1}{-\frac{1}{\sqrt{2}}} \\
 &= -\sqrt{2}
 \end{aligned}$$

$$\begin{aligned}
 \mathbf{b} \quad \operatorname{cosec}\left(-\frac{23\pi}{4}\right) &= \operatorname{cosec}\left(-6\pi + \frac{\pi}{4}\right) \\
 &= \operatorname{cosec}\left(\frac{\pi}{4}\right) \\
 &= \frac{1}{\sin\left(\frac{\pi}{4}\right)} \\
 &= \frac{1}{\frac{1}{\sqrt{2}}} \\
 &= \sqrt{2}
 \end{aligned}$$

$$\begin{aligned}
 \mathbf{c} \quad \cot\left(\frac{11\pi}{3}\right) &= \cot\left(4\pi - \frac{\pi}{3}\right) \\
 &= \cot\left(-\frac{\pi}{3}\right) \\
 &= -\cot\left(\frac{\pi}{3}\right) \\
 &= -\frac{1}{\tan\left(\frac{\pi}{3}\right)} \\
 &= -\frac{1}{\sqrt{3}}
 \end{aligned}$$

► Two new identities

The Pythagorean identity $\sin^2 x + \cos^2 x = 1$ holds for all values of x .

From this identity, we can derive the following two additional identities:

$$1 + \cot^2 x = \operatorname{cosec}^2 x \quad \text{provided } \sin x \neq 0$$

$$1 + \tan^2 x = \sec^2 x \quad \text{provided } \cos x \neq 0$$

Proof The first identity is obtained by dividing each term in the Pythagorean identity by $\sin^2 x$:

$$\frac{\sin^2 x}{\sin^2 x} + \frac{\cos^2 x}{\sin^2 x} = \frac{1}{\sin^2 x}$$

$$\therefore 1 + \cot^2 x = \operatorname{cosec}^2 x$$

The derivation of the second identity is left as an exercise.

Example 4

Simplify the expression

$$\frac{\cos x - \cos^3 x}{\cot x}$$

Solution

$$\begin{aligned} \frac{\cos x - \cos^3 x}{\cot x} &= \frac{\cos x \cdot (1 - \cos^2 x)}{\cot x} \\ &= \cos x \cdot \sin^2 x \cdot \frac{\sin x}{\cos x} \\ &= \sin^3 x \end{aligned}$$

Example 5

If $\tan x = 2$ and $x \in \left[0, \frac{\pi}{2}\right]$, find:

a $\sec x$

b $\cos x$

c $\sin x$

d $\operatorname{cosec} x$

Solution

a $\sec^2 x = 1 + \tan^2 x$
 $= 1 + 4$

$$\therefore \sec x = \pm\sqrt{5}$$

Since $x \in \left(0, \frac{\pi}{2}\right)$, we have $\sec x = \sqrt{5}$.

c $\sin x = \tan x \cdot \cos x = \frac{2\sqrt{5}}{5}$

b $\cos x = \frac{1}{\sec x} = \frac{\sqrt{5}}{5}$

d $\operatorname{cosec} x = \frac{1}{\sin x} = \frac{\sqrt{5}}{2}$

Using the TI-Nspire

- Choose **solve** from the **Algebra** menu and complete as shown.
- Assign (ctrl =) or store (ctrl var) the answer as the variable a to obtain the results.

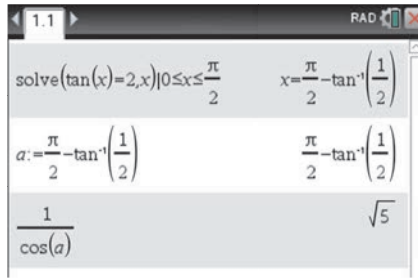

$$\text{solve}(\tan(x)=2,x)|0 \leq x \leq \frac{\pi}{2} \quad x = \frac{\pi}{2} - \tan^{-1}\left(\frac{1}{2}\right)$$

$$\alpha := \frac{\pi}{2} - \tan^{-1}\left(\frac{1}{2}\right) \quad \frac{\pi}{2} - \tan^{-1}\left(\frac{1}{2}\right)$$

$$\frac{1}{\cos(\alpha)} \quad \sqrt{5}$$



$$\cos(\alpha) \quad \frac{\sqrt{5}}{5}$$

$$\sin(\alpha) \quad \frac{2 \cdot \sqrt{5}}{5}$$

$$\frac{1}{\sin(\alpha)} \quad \frac{\sqrt{5}}{2}$$

Using the Casio ClassPad

- In $\sqrt{\square}$, enter and highlight: $\tan(x) = 2 \mid 0 \leq x \leq \frac{\pi}{2}$
- Go to **Interactive** > **Equation/Inequality** > **solve**.
- Highlight the answer and drag it to the next entry line. Enter $\Rightarrow a$.
- The results are obtained as shown.

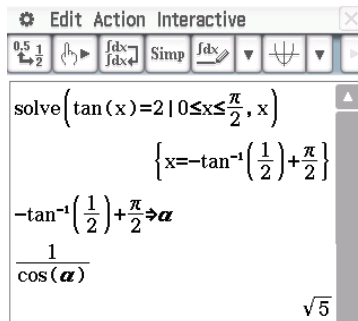

$$\text{solve}(\tan(x)=2|0 \leq x \leq \frac{\pi}{2}, x)$$

$$\left\{ x = -\tan^{-1}\left(\frac{1}{2}\right) + \frac{\pi}{2} \right\}$$

$$-\tan^{-1}\left(\frac{1}{2}\right) + \frac{\pi}{2} \Rightarrow \alpha$$

$$\frac{1}{\cos(\alpha)} \quad \sqrt{5}$$

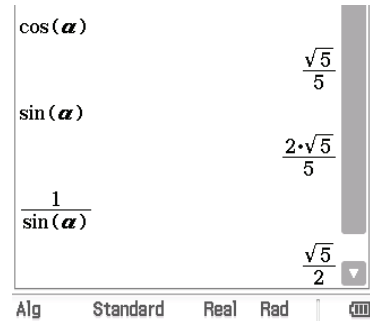

$$\cos(\alpha) \quad \frac{\sqrt{5}}{5}$$

$$\sin(\alpha) \quad \frac{2 \cdot \sqrt{5}}{5}$$

$$\frac{1}{\sin(\alpha)} \quad \frac{\sqrt{5}}{2}$$

Exercise 3A

Example 1

1 Sketch the graph of each of the following over the interval $[0, 2\pi]$:

a $y = \operatorname{cosec}\left(x + \frac{\pi}{4}\right)$
b $y = \sec\left(x - \frac{\pi}{6}\right)$
c $y = \cot\left(x + \frac{\pi}{3}\right)$
d $y = \sec\left(x + \frac{2\pi}{3}\right)$
e $y = \operatorname{cosec}\left(x - \frac{\pi}{2}\right)$
f $y = \cot\left(x - \frac{3\pi}{4}\right)$

2 Sketch the graph of each of the following over the interval $[0, \pi]$:

a $y = \sec(2x)$
b $y = \operatorname{cosec}(3x)$
c $y = \cot(4x)$
d $y = \operatorname{cosec}\left(2x + \frac{\pi}{2}\right)$
e $y = \sec(2x + \pi)$
f $y = \cot\left(2x - \frac{\pi}{3}\right)$

3 Sketch the graph of each of the following over the interval $[-\pi, \pi]$:

a $y = \sec\left(2x - \frac{\pi}{2}\right)$
b $y = \operatorname{cosec}\left(2x + \frac{\pi}{3}\right)$
c $y = \cot\left(2x - \frac{2\pi}{3}\right)$

Example 2 4 Find the trigonometric ratios $\cot(x^\circ)$, $\sec(x^\circ)$ and $\operatorname{cosec}(x^\circ)$ for each of the following triangles:

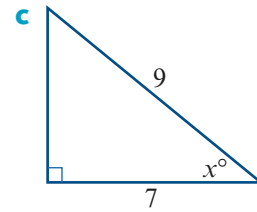
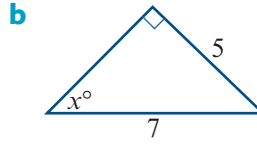
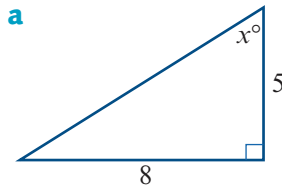

Example 3 5 Find the exact value of each of the following:

- | | | | |
|--|--|--|---|
| a $\sin\left(\frac{2\pi}{3}\right)$ | b $\cos\left(\frac{3\pi}{4}\right)$ | c $\tan\left(-\frac{\pi}{4}\right)$ | d $\operatorname{cosec}\left(\frac{\pi}{6}\right)$ |
| e $\sec\left(\frac{\pi}{4}\right)$ | f $\cot\left(-\frac{\pi}{6}\right)$ | g $\sin\left(\frac{5\pi}{4}\right)$ | h $\tan\left(\frac{5\pi}{6}\right)$ |
| i $\sec\left(-\frac{\pi}{3}\right)$ | j $\operatorname{cosec}\left(\frac{3\pi}{4}\right)$ | k $\cot\left(\frac{9\pi}{4}\right)$ | l $\cos\left(-\frac{7\pi}{3}\right)$ |

Example 4 6 Simplify each of the following expressions:

- | | | |
|---|--|--|
| a $\sec^2 x - \tan^2 x$ | b $\cot^2 x - \operatorname{cosec}^2 x$ | c $\frac{\tan^2 x + 1}{\tan^2 x}$ |
| d $\frac{\sin^2 x}{\cos x} + \cos x$ | e $\sin^4 x - \cos^4 x$ | f $\tan^3 x + \tan x$ |

Example 5 7 If $\tan x = -4$ and $x \in \left(-\frac{\pi}{2}, 0\right)$, find:

- a** $\sec x$ **b** $\cos x$ **c** $\operatorname{cosec} x$

8 If $\cot x = 3$ and $x \in \left(\pi, \frac{3\pi}{2}\right)$, find:

- a** $\operatorname{cosec} x$ **b** $\sin x$ **c** $\sec x$

9 If $\sec x = 10$ and $x \in \left(-\frac{\pi}{2}, 0\right)$, find:

- a** $\tan x$ **b** $\sin x$

10 If $\operatorname{cosec} x = -6$ and $x \in \left(\frac{3\pi}{2}, 2\pi\right)$, find:

- a** $\cot x$ **b** $\cos x$

11 If $\sin x^\circ = 0.5$ and $90 < x < 180$, find:

- a** $\cos x^\circ$ **b** $\cot x^\circ$ **c** $\operatorname{cosec} x^\circ$

12 If $\operatorname{cosec} x^\circ = -3$ and $180 < x < 270$, find:

- a** $\sin x^\circ$ **b** $\cos x^\circ$ **c** $\sec x^\circ$

13 If $\cos x^\circ = -0.7$ and $0 < x < 180$, find:

- a** $\sin x^\circ$ **b** $\tan x^\circ$ **c** $\cot x^\circ$

14 If $\sec x^\circ = 5$ and $180 < x < 360$, find:

- a** $\cos x^\circ$ **b** $\sin x^\circ$ **c** $\cot x^\circ$

15 Simplify each of the following expressions:

- a** $\sec^2 \theta + \operatorname{cosec}^2 \theta - \sec^2 \theta \operatorname{cosec}^2 \theta$ **b** $(\sec \theta - \cos \theta)(\operatorname{cosec} \theta - \sin \theta)$
c $(1 - \cos^2 \theta)(1 + \cot^2 \theta)$ **d** $\frac{\sec^2 \theta - \operatorname{cosec}^2 \theta}{\tan^2 \theta - \cot^2 \theta}$

16 Let $x = \sec \theta - \tan \theta$. Prove that $x + \frac{1}{x} = 2 \sec \theta$ and also find a simple expression for $x - \frac{1}{x}$ in terms of θ .



3B Compound and double angle formulas

► The compound angle formulas



The following identities are known as the compound angle formulas. These identities were proved in Specialist Mathematics Year 11.

Compound angle formulas

- $\cos(x + y) = \cos x \cos y - \sin x \sin y$
- $\cos(x - y) = \cos x \cos y + \sin x \sin y$
- $\sin(x + y) = \sin x \cos y + \cos x \sin y$
- $\sin(x - y) = \sin x \cos y - \cos x \sin y$
- $\tan(x + y) = \frac{\tan x + \tan y}{1 - \tan x \tan y}$
- $\tan(x - y) = \frac{\tan x - \tan y}{1 + \tan x \tan y}$



Example 6

- a** Use $\frac{5\pi}{12} = \frac{\pi}{6} + \frac{\pi}{4}$ to evaluate $\sin\left(\frac{5\pi}{12}\right)$. **b** Use $\frac{\pi}{12} = \frac{\pi}{3} - \frac{\pi}{4}$ to evaluate $\cos\left(\frac{\pi}{12}\right)$.

Solution

$$\begin{aligned} \mathbf{a} \quad & \sin\left(\frac{5\pi}{12}\right) \\ &= \sin\left(\frac{\pi}{6} + \frac{\pi}{4}\right) \\ &= \sin\left(\frac{\pi}{6}\right) \cos\left(\frac{\pi}{4}\right) + \cos\left(\frac{\pi}{6}\right) \sin\left(\frac{\pi}{4}\right) \\ &= \frac{1}{2} \times \frac{1}{\sqrt{2}} + \frac{\sqrt{3}}{2} \times \frac{1}{\sqrt{2}} \\ &= \frac{\sqrt{2}}{4}(1 + \sqrt{3}) \end{aligned}$$

$$\begin{aligned} \mathbf{b} \quad & \cos\left(\frac{\pi}{12}\right) \\ &= \cos\left(\frac{\pi}{3} - \frac{\pi}{4}\right) \\ &= \cos\left(\frac{\pi}{3}\right) \cos\left(\frac{\pi}{4}\right) + \sin\left(\frac{\pi}{3}\right) \sin\left(\frac{\pi}{4}\right) \\ &= \frac{1}{2} \times \frac{1}{\sqrt{2}} + \frac{\sqrt{3}}{2} \times \frac{1}{\sqrt{2}} \\ &= \frac{\sqrt{2}}{4}(1 + \sqrt{3}) \end{aligned}$$

Example 7

If $\sin x = 0.2$ and $\cos y = -0.4$, where $x \in \left[0, \frac{\pi}{2}\right]$ and $y \in \left[\pi, \frac{3\pi}{2}\right]$, find $\sin(x + y)$.

Solution

We first find $\cos x$ and $\sin y$.

$$\begin{aligned} \cos x &= \pm\sqrt{1-0.2^2} \quad \text{as } \sin x = 0.2 & \sin y &= \pm\sqrt{1-(-0.4)^2} \quad \text{as } \cos y = -0.4 \\ &= \pm\sqrt{0.96} & &= \pm\sqrt{0.84} \\ \therefore \cos x &= \sqrt{0.96} \quad \text{as } x \in \left[0, \frac{\pi}{2}\right] & \therefore \sin y &= -\sqrt{0.84} \quad \text{as } y \in \left[\pi, \frac{3\pi}{2}\right] \\ &= \frac{2\sqrt{6}}{5} & &= -\frac{\sqrt{21}}{5} \end{aligned}$$

Hence

$$\begin{aligned} \sin(x + y) &= \sin x \cos y + \cos x \sin y \\ &= 0.2 \times (-0.4) + \frac{2\sqrt{6}}{5} \times \left(-\frac{\sqrt{21}}{5}\right) \\ &= -0.08 - \frac{2}{25} \times 3\sqrt{14} \\ &= -\frac{2}{25}(1 + 3\sqrt{14}) \end{aligned}$$

Using the TI-Nspire

- First solve $\sin(x) = 0.2$ for $0 \leq x \leq \frac{\pi}{2}$.
- Assign the result to a .
- Then solve $\cos(y) = -0.4$ for $\pi \leq y \leq \frac{3\pi}{2}$.
- Assign the result to b .

Note: If a decimal is entered, then the answer will be given in approximate form, even in **Auto** mode. To obtain an exact answer, use **exact**(at the start of the entry or write the decimal as a fraction.

- Use $\left[\text{menu}\right] > \text{Algebra} > \text{Trigonometry} > \text{Expand}$ to expand the expression $\sin(a + b)$.

TI-Nspire calculator screen showing the command: `exact(solve(sin(x)=0.2,x)|0≤x≤π/2)`. The result is $x = \sin^{-1}\left(\frac{1}{5}\right)$. Below, the variable a is assigned: $a := \sin^{-1}\left(\frac{1}{5}\right)$.

TI-Nspire calculator screen showing the command: `exact(solve(cos(y)=-0.4,y)|π≤y≤3π/2)`. The result is $y = \frac{3\pi}{2} - \sin^{-1}\left(\frac{2}{5}\right)$. Below, the variable b is assigned: $b := \frac{3\pi}{2} - \sin^{-1}\left(\frac{2}{5}\right)$. Finally, the command `tExpand(sin(a+b))` is used to expand the expression, resulting in $\frac{-6\sqrt{14} - 2}{25}$.

Using the Casio ClassPad

- Solve $\sin(x) = 0.2 \mid 0 \leq x \leq \frac{\pi}{2}$ for x .
- Solve $\cos(y) = -0.4 \mid \pi \leq y \leq \frac{3\pi}{2}$ for y .
- Paste the results to form the expression

$$\sin\left(\sin^{-1}\left(\frac{1}{5}\right) + \cos^{-1}\left(\frac{2}{5}\right) + \pi\right)$$
- Highlight and go to **Interactive** > **Transformation** > **tExpand**.

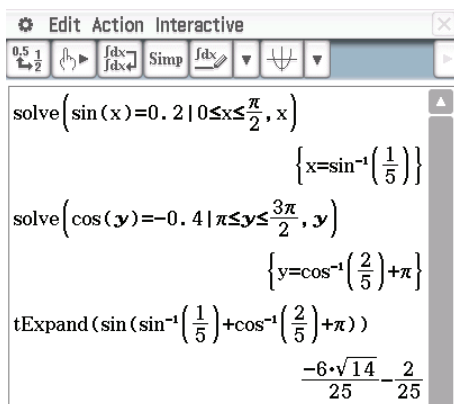

► The double angle formulas

Double angle formulas

$$\begin{aligned} \blacksquare \cos(2x) &= \cos^2 x - \sin^2 x & \blacksquare \sin(2x) &= 2 \sin x \cos x & \blacksquare \tan(2x) &= \frac{2 \tan x}{1 - \tan^2 x} \\ &= 1 - 2 \sin^2 x \\ &= 2 \cos^2 x - 1 \end{aligned}$$

Proof These formulas can be derived from the compound angle formulas. For example:

$$\begin{aligned} \cos(x+y) &= \cos x \cos y - \sin x \sin y \\ \therefore \cos(x+x) &= \cos x \cos x - \sin x \sin x \\ \therefore \cos(2x) &= \cos^2 x - \sin^2 x \end{aligned}$$

The two other expressions for $\cos(2x)$ are obtained using the Pythagorean identity:

$$\begin{aligned} \cos^2 x - \sin^2 x &= (1 - \sin^2 x) - \sin^2 x \\ &= 1 - 2 \sin^2 x \\ \text{and } \cos^2 x - \sin^2 x &= \cos^2 x - (1 - \cos^2 x) \\ &= 2 \cos^2 x - 1 \end{aligned}$$

Example 8

If $\sin \alpha = 0.6$ and $\alpha \in \left[\frac{\pi}{2}, \pi\right]$, find $\sin(2\alpha)$.

Solution

$$\begin{aligned} \cos \alpha &= \pm \sqrt{1 - 0.6^2} & \text{since } \sin \alpha &= 0.6 \\ &= \pm 0.8 \\ \therefore \cos \alpha &= -0.8 & \text{since } \alpha &\in \left[\frac{\pi}{2}, \pi\right] \end{aligned}$$

Hence

$$\begin{aligned}\sin(2\alpha) &= 2 \sin \alpha \cos \alpha \\ &= 2 \times 0.6 \times (-0.8) \\ &= -0.96\end{aligned}$$

Example 9

If $\cos \alpha = 0.7$ and $\alpha \in \left[\frac{3\pi}{2}, 2\pi\right]$, find $\sin\left(\frac{\alpha}{2}\right)$.

Solution

We use a double angle formula:

$$\begin{aligned}\cos(2x) &= 1 - 2 \sin^2 x \\ \therefore \cos \alpha &= 1 - 2 \sin^2\left(\frac{\alpha}{2}\right) \\ 2 \sin^2\left(\frac{\alpha}{2}\right) &= 1 - 0.7 \\ &= 0.3 \\ \sin\left(\frac{\alpha}{2}\right) &= \pm \sqrt{0.15}\end{aligned}$$

Since $\alpha \in \left[\frac{3\pi}{2}, 2\pi\right]$, we have $\frac{\alpha}{2} \in \left[\frac{3\pi}{4}, \pi\right]$, so $\sin\left(\frac{\alpha}{2}\right)$ is positive.

Hence

$$\sin\left(\frac{\alpha}{2}\right) = \sqrt{0.15} = \frac{\sqrt{15}}{10}$$

Exercise 3B

Skillsheet

Example 6

1 Use the compound angle formulas and appropriate angles to find the exact value of each of the following:

a $\sin\left(\frac{\pi}{12}\right)$ **b** $\tan\left(\frac{5\pi}{12}\right)$ **c** $\cos\left(\frac{7\pi}{12}\right)$ **d** $\tan\left(\frac{\pi}{12}\right)$

2 Use the compound angle formulas to expand each of the following:

a $\sin(2x - 5y)$ **b** $\cos(x^2 + y)$ **c** $\tan(x + (y + z))$

3 Simplify each of the following:

a $\sin(x) \cos(2y) - \cos(x) \sin(2y)$ **b** $\cos(3x) \cos(2x) + \sin(3x) \sin(2x)$
c $\frac{\tan A - \tan(A - B)}{1 + \tan A \tan(A - B)}$ **d** $\sin(A + B) \cos(A - B) + \cos(A + B) \sin(A - B)$
e $\cos(y) \cos(-2y) - \sin(y) \sin(-2y)$

4 a Expand $\sin(x + 2x)$. **b** Hence express $\sin(3x)$ in terms of $\sin x$.

5 a Expand $\cos(x + 2x)$. **b** Hence express $\cos(3x)$ in terms of $\cos x$.

Example 7

6 If $\sin x = 0.6$ and $\tan y = 2.4$, where $x \in \left[\frac{\pi}{2}, \pi\right]$ and $y \in \left[0, \frac{\pi}{2}\right]$, find the exact value of each of the following:

a $\cos x$ **b** $\sec y$ **c** $\cos y$ **d** $\sin y$ **e** $\tan x$ **f** $\cos(x - y)$ **g** $\sin(x - y)$ **h** $\tan(x + y)$ **i** $\tan(x + 2y)$

7 If $\cos x = -0.7$ and $\sin y = 0.4$, where $x \in \left[\pi, \frac{3\pi}{2}\right]$ and $y \in \left[0, \frac{\pi}{2}\right]$, find the value of each of the following, correct to two decimal places:

a $\sin x$ **b** $\cos y$ **c** $\tan(x - y)$ **d** $\cos(x + y)$

8 Simplify each of the following:

a $\frac{1}{2} \sin x \cos x$ **b** $\sin^2 x - \cos^2 x$ **c** $\frac{\tan x}{1 - \tan^2 x}$ **d** $\frac{\sin^4 x - \cos^4 x}{\cos(2x)}$ **e** $\frac{4 \sin^3 x - 2 \sin x}{\cos x \cos(2x)}$ **f** $\frac{4 \sin^2 x - 4 \sin^4 x}{\sin(2x)}$ **Example 8**

9 If $\sin x = -0.8$ and $x \in \left[\pi, \frac{3\pi}{2}\right]$, find:

a $\sin(2x)$ **b** $\cos(2x)$ **c** $\tan(2x)$

10 If $\tan x = 3$ and $x \in \left(0, \frac{\pi}{2}\right)$, find:

a $\tan(2x)$ **b** $\tan(3x)$ **Example 9**

11 If $\sin x = -0.75$ and $x \in \left[\pi, \frac{3\pi}{2}\right]$, find correct to two decimal places:

a $\cos x$ **b** $\sin\left(\frac{1}{2}x\right)$

12 Use the double angle formula for $\tan(2x)$ and the fact that $\tan\left(\frac{\pi}{4}\right) = 1$ to find the exact value of $\tan\left(\frac{\pi}{8}\right)$.

13 If $\cos x = 0.9$ and $x \in \left[0, \frac{\pi}{2}\right]$, find $\cos\left(\frac{1}{2}x\right)$ correct to two decimal places.

14 In a right-angled triangle GAP , $AP = 12$ m and $GA = 5$ m. The point T on AP is such that $\angle AGT = \angle TGP = x^\circ$. Without using a calculator, find the exact values of the following:

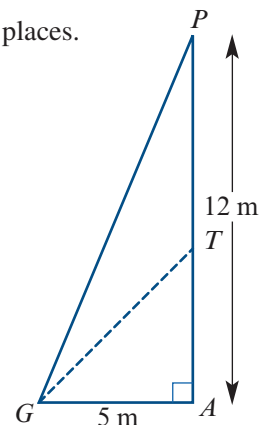
a $\tan(2x)$ **b** $\tan x$, by using the double angle formula**c** AT 

3C Inverses of circular functions



As the circular functions sine, cosine and tangent are periodic, they are not one-to-one and therefore they do not have inverse functions. However, by restricting their domains to form one-to-one functions, we can define the inverse circular functions.

► The inverse sine function: $y = \sin^{-1} x$

Restricting the sine function

When the domain of the sine function is restricted to the interval $\left[-\frac{\pi}{2}, \frac{\pi}{2}\right]$, the resulting function is one-to-one and therefore has an inverse function.

Note: Other intervals (defined through consecutive turning points of the graph) could have been used for the restricted domain, but this is the convention.

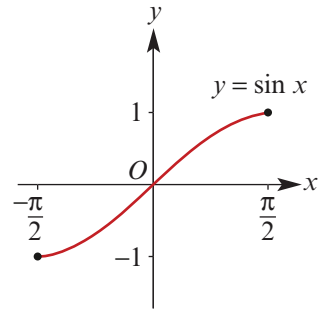

Defining the inverse function

The inverse of the restricted sine function is usually denoted by \sin^{-1} or arcsin.

Inverse sine function

$$\sin^{-1}: [-1, 1] \rightarrow \mathbb{R}, \quad \sin^{-1} x = y, \quad \text{where } \sin y = x \text{ and } y \in \left[-\frac{\pi}{2}, \frac{\pi}{2}\right]$$

The graph of $y = \sin^{-1} x$ is obtained from the graph of $y = \sin x$, $x \in \left[-\frac{\pi}{2}, \frac{\pi}{2}\right]$, through a reflection in the line $y = x$.

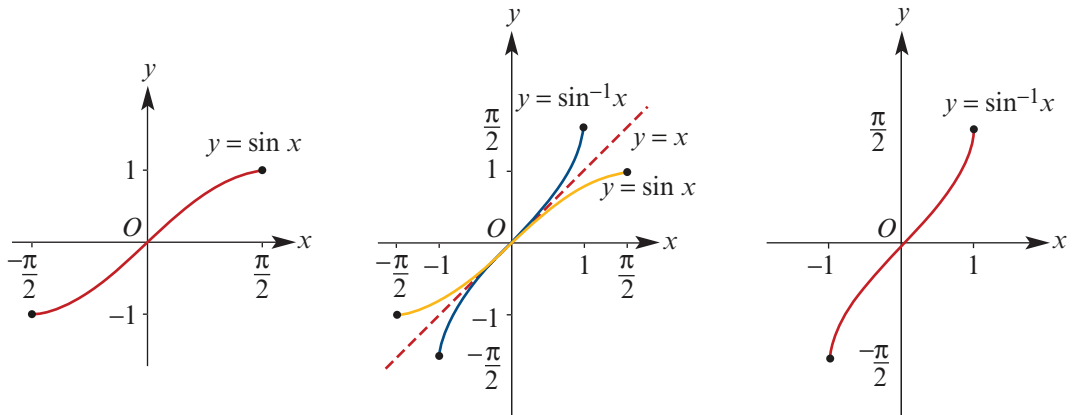

■ **Domain** Domain of $\sin^{-1} =$ range of restricted sine function $= [-1, 1]$

■ **Range** Range of $\sin^{-1} =$ domain of restricted sine function $= \left[-\frac{\pi}{2}, \frac{\pi}{2}\right]$

■ Composition

- $\sin(\sin^{-1} x) = x$ for all $x \in [-1, 1]$
- $\sin^{-1}(\sin x) = x$ for all $x \in \left[-\frac{\pi}{2}, \frac{\pi}{2}\right]$

► **The inverse cosine function: $y = \cos^{-1} x$**

The standard domain for the restricted cosine function is $[0, \pi]$.

The restricted cosine function is one-to-one, and its inverse is denoted by \cos^{-1} or arccos.

Inverse cosine function

$$\cos^{-1}: [-1, 1] \rightarrow \mathbb{R}, \cos^{-1} x = y, \text{ where } \cos y = x \text{ and } y \in [0, \pi]$$

The graph of $y = \cos^{-1} x$ is obtained from the graph of $y = \cos x$, $x \in [0, \pi]$, through a reflection in the line $y = x$.

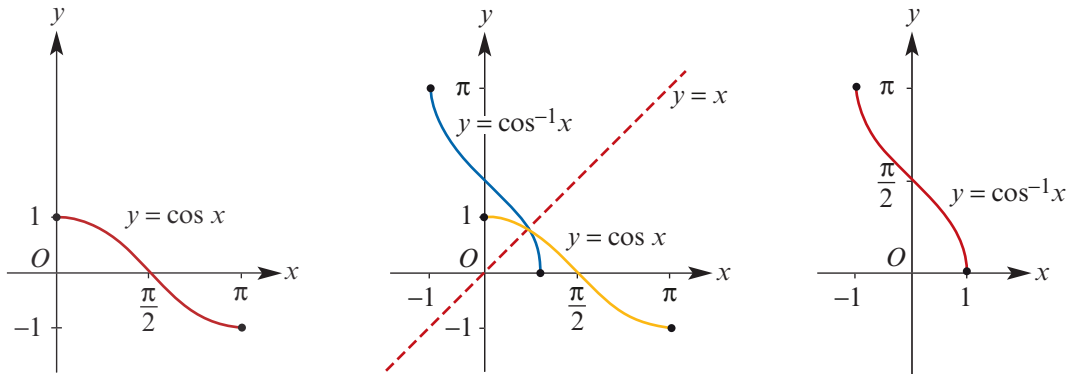

■ **Domain** Domain of $\cos^{-1} =$ range of restricted cosine function $= [-1, 1]$

■ **Range** Range of $\cos^{-1} =$ domain of restricted cosine function $= [0, \pi]$

■ **Composition**

- $\cos(\cos^{-1} x) = x$ for all $x \in [-1, 1]$
- $\cos^{-1}(\cos x) = x$ for all $x \in [0, \pi]$

► **The inverse tangent function: $y = \tan^{-1} x$**

The domain of the restricted tangent function is $\left(-\frac{\pi}{2}, \frac{\pi}{2}\right)$.

The restricted tangent function is one-to-one, and its inverse is denoted by \tan^{-1} or arctan.

Inverse tangent function

$$\tan^{-1}: \mathbb{R} \rightarrow \mathbb{R}, \tan^{-1} x = y, \text{ where } \tan y = x \text{ and } y \in \left(-\frac{\pi}{2}, \frac{\pi}{2}\right)$$

The graph of $y = \tan^{-1} x$ is obtained from the graph of $y = \tan x$, $x \in \left(-\frac{\pi}{2}, \frac{\pi}{2}\right)$, through a reflection in the line $y = x$.

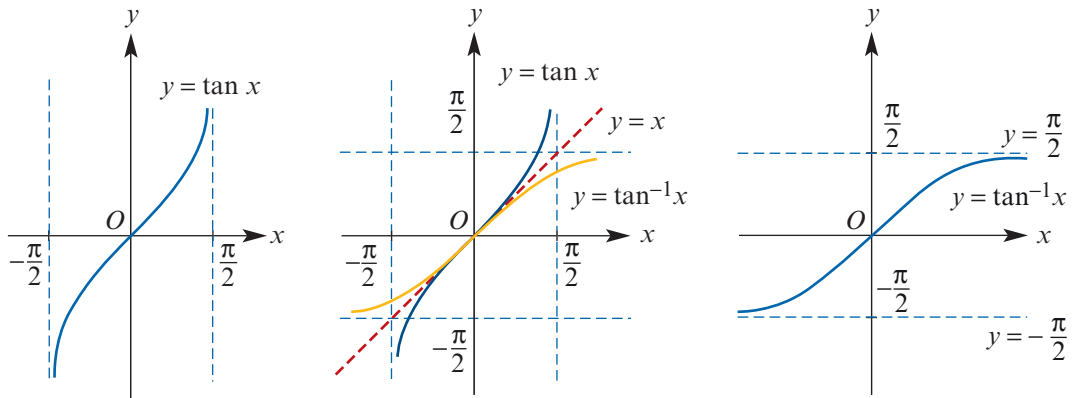

- **Domain** Domain of $\tan^{-1} =$ range of restricted tangent function $= \mathbb{R}$
- **Range** Range of $\tan^{-1} =$ domain of restricted tangent function $= \left(-\frac{\pi}{2}, \frac{\pi}{2}\right)$
- **Composition**
 - $\tan(\tan^{-1} x) = x$ for all $x \in \mathbb{R}$
 - $\tan^{-1}(\tan x) = x$ for all $x \in \left(-\frac{\pi}{2}, \frac{\pi}{2}\right)$



Example 10

Sketch the graph of each of the following functions for the maximal domain:

- a** $y = \cos^{-1}(2 - 3x)$
b $y = \tan^{-1}(x + 2) + \frac{\pi}{2}$

Solution

$$\begin{aligned} \mathbf{a} \quad \cos^{-1}(2 - 3x) \text{ is defined} &\Leftrightarrow -1 \leq 2 - 3x \leq 1 \\ &\Leftrightarrow -3 \leq -3x \leq -1 \\ &\Leftrightarrow \frac{1}{3} \leq x \leq 1 \end{aligned}$$

The implied domain is $\left[\frac{1}{3}, 1\right]$.

We can write $y = \cos^{-1}\left(-3\left(x - \frac{2}{3}\right)\right)$.

The graph is obtained from the graph of $y = \cos^{-1} x$ by the following sequence of transformations:

- a dilation of factor $\frac{1}{3}$ from the y -axis
- a reflection in the y -axis
- a translation of $\frac{2}{3}$ units in the positive direction of the x -axis.

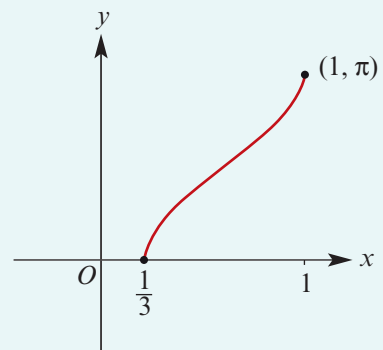

b The domain of \tan^{-1} is \mathbb{R} .

The graph of

$$y = \tan^{-1}(x + 2) + \frac{\pi}{2}$$

is obtained from the graph of $y = \tan^{-1} x$ by a translation of 2 units in the negative direction of the x -axis and $\frac{\pi}{2}$ units in the positive direction of the y -axis.

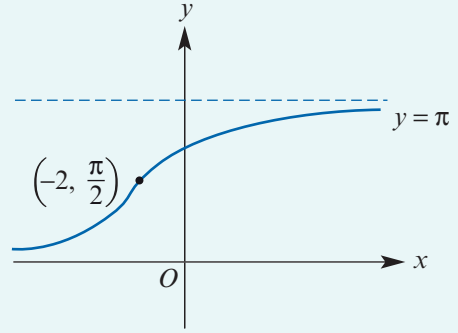

Example 11

a Evaluate $\sin^{-1}\left(-\frac{\sqrt{3}}{2}\right)$.

b Simplify:

i $\sin^{-1}\left(\sin\left(\frac{\pi}{6}\right)\right)$

ii $\sin^{-1}\left(\sin\left(\frac{5\pi}{6}\right)\right)$

iii $\sin^{-1}\left(\cos\left(\frac{\pi}{3}\right)\right)$

iv $\sin\left(\cos^{-1}\left(\frac{1}{\sqrt{2}}\right)\right)$

Solution

a Evaluating $\sin^{-1}\left(-\frac{\sqrt{3}}{2}\right)$ is equivalent to solving $\sin y = -\frac{\sqrt{3}}{2}$ for $y \in \left[-\frac{\pi}{2}, \frac{\pi}{2}\right]$.

$$\sin\left(\frac{\pi}{3}\right) = \frac{\sqrt{3}}{2}$$

$$\therefore \sin\left(-\frac{\pi}{3}\right) = -\frac{\sqrt{3}}{2}$$

$$\therefore \sin^{-1}\left(-\frac{\sqrt{3}}{2}\right) = -\frac{\pi}{3}$$

b i Since $\frac{\pi}{6} \in \left[-\frac{\pi}{2}, \frac{\pi}{2}\right]$, by definition we have

$$\sin^{-1}\left(\sin\left(\frac{\pi}{6}\right)\right) = \frac{\pi}{6}$$

ii $\sin^{-1}\left(\sin\left(\frac{5\pi}{6}\right)\right) = \sin^{-1}\left(\sin\left(\pi - \frac{5\pi}{6}\right)\right)$

$$= \sin^{-1}\left(\sin\left(\frac{\pi}{6}\right)\right)$$

$$= \frac{\pi}{6}$$

iii $\sin^{-1}\left(\cos\left(\frac{\pi}{3}\right)\right) = \sin^{-1}\left(\sin\left(\frac{\pi}{2} - \frac{\pi}{3}\right)\right)$

$$= \sin^{-1}\left(\sin\left(\frac{\pi}{6}\right)\right)$$

$$= \frac{\pi}{6}$$

iv $\sin\left(\cos^{-1}\left(\frac{1}{\sqrt{2}}\right)\right) = \sin\left(\frac{\pi}{4}\right)$

$$= \frac{1}{\sqrt{2}}$$

Example 12

Find the implied domain and range of:

a $y = \sin^{-1}(2x - 1)$

b $y = 3 \cos^{-1}(2 - 2x)$

Solution**a** For $\sin^{-1}(2x - 1)$ to be defined:

$$\begin{aligned} -1 &\leq 2x - 1 \leq 1 \\ \Leftrightarrow 0 &\leq 2x \leq 2 \\ \Leftrightarrow 0 &\leq x \leq 1 \end{aligned}$$

Thus the implied domain is $[0, 1]$.

The range is $\left[-\frac{\pi}{2}, \frac{\pi}{2}\right]$.

b For $3 \cos^{-1}(2 - 2x)$ to be defined:

$$\begin{aligned} -1 &\leq 2 - 2x \leq 1 \\ \Leftrightarrow -3 &\leq -2x \leq -1 \\ \Leftrightarrow \frac{1}{2} &\leq x \leq \frac{3}{2} \end{aligned}$$

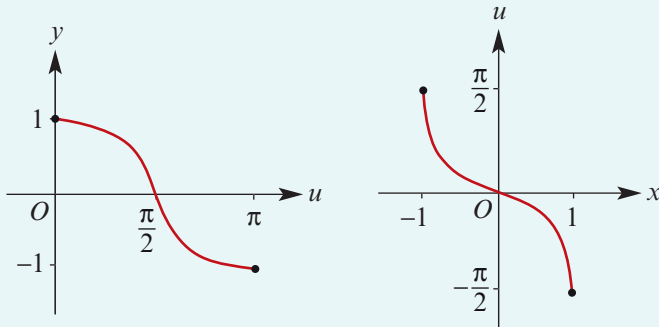
Thus the implied domain is $\left[\frac{1}{2}, \frac{3}{2}\right]$.The range is $[0, 3\pi]$.**Example 13**Find the implied domain and range of $y = \cos(-\sin^{-1} x)$, where \cos has the restricted domain $[0, \pi]$.**Solution**Let $y = \cos u$, $u \in [0, \pi]$.Let $u = -\sin^{-1} x$.From the graphs, it can be seen that the function $u = -\sin^{-1} x$ has range $\left[-\frac{\pi}{2}, \frac{\pi}{2}\right]$.But for $y = \cos u$ to be defined, the value of u must belong to the domain of $y = \cos u$, which is $[0, \pi]$. Hence the values of u must belong to the interval $\left[0, \frac{\pi}{2}\right]$.

$$\begin{aligned} 0 \leq u \leq \frac{\pi}{2} &\Leftrightarrow 0 \leq -\sin^{-1} x \leq \frac{\pi}{2} \quad (\text{since } u = -\sin^{-1} x) \\ &\Leftrightarrow -\frac{\pi}{2} \leq \sin^{-1} x \leq 0 \\ &\Leftrightarrow -1 \leq x \leq 0 \end{aligned}$$

Hence the domain of $y = \cos(-\sin^{-1} x)$ is $[-1, 0]$. The range is $[0, 1]$.

Exercise 3C

Skillsheet

- 1** Sketch the graphs of the following functions, stating clearly the implied domain and the range of each:

Example 10

a $y = \tan^{-1}(x - 1)$	b $y = \cos^{-1}(x + 1)$	c $y = 2 \sin^{-1}\left(x + \frac{1}{2}\right)$
d $y = 2 \tan^{-1}(x) + \frac{\pi}{2}$	e $y = \cos^{-1}(2x)$	f $y = \frac{1}{2} \sin^{-1}(3x) + \frac{\pi}{4}$

Example 11a

- 2** Evaluate each of the following:

a $\arcsin 1$	b $\arcsin\left(-\frac{1}{\sqrt{2}}\right)$	c $\arcsin 0.5$
d $\cos^{-1}\left(-\frac{\sqrt{3}}{2}\right)$	e $\cos^{-1} 0.5$	f $\tan^{-1} 1$
g $\tan^{-1}(-\sqrt{3})$	h $\tan^{-1}\left(\frac{1}{\sqrt{3}}\right)$	i $\cos^{-1}(-1)$

Example 11b

- 3** Simplify:

a $\sin(\cos^{-1} 0.5)$	b $\sin^{-1}\left(\cos\left(\frac{5\pi}{6}\right)\right)$	c $\tan\left(\sin^{-1}\left(-\frac{1}{\sqrt{2}}\right)\right)$
d $\cos(\tan^{-1} 1)$	e $\tan^{-1}\left(\sin\left(\frac{5\pi}{2}\right)\right)$	f $\tan(\cos^{-1} 0.5)$
g $\cos^{-1}\left(\cos\left(\frac{7\pi}{3}\right)\right)$	h $\sin^{-1}\left(\sin\left(-\frac{2\pi}{3}\right)\right)$	i $\tan^{-1}\left(\tan\left(\frac{11\pi}{4}\right)\right)$
j $\cos^{-1}\left(\sin\left(-\frac{\pi}{3}\right)\right)$	k $\cos^{-1}\left(\tan\left(-\frac{\pi}{4}\right)\right)$	l $\sin^{-1}\left(\cos\left(-\frac{3\pi}{4}\right)\right)$

- 4** Let $f: \left[\frac{\pi}{2}, \frac{3\pi}{2}\right] \rightarrow \mathbb{R}$, $f(x) = \sin x$.

a Define f^{-1} , clearly stating its domain and its range.

b Evaluate:

i $f\left(\frac{\pi}{2}\right)$	ii $f\left(\frac{3\pi}{4}\right)$	iii $f\left(\frac{7\pi}{6}\right)$
iv $f^{-1}(-1)$	v $f^{-1}(0)$	vi $f^{-1}(0.5)$

Example 12

- 5** Given that the domains of \sin , \cos and \tan are restricted to $\left[-\frac{\pi}{2}, \frac{\pi}{2}\right]$, $[0, \pi]$ and $\left(-\frac{\pi}{2}, \frac{\pi}{2}\right)$ respectively, give the implied domain and range of each of the following:

a $y = \sin^{-1}(2 - x)$	b $y = \sin\left(x + \frac{\pi}{4}\right)$	c $y = \sin^{-1}(2x + 4)$
d $y = \sin\left(3x - \frac{\pi}{3}\right)$	e $y = \cos\left(x - \frac{\pi}{6}\right)$	f $y = \cos^{-1}(x + 1)$
g $y = \cos^{-1}(x^2)$	h $y = \cos\left(2x + \frac{2\pi}{3}\right)$	i $y = \tan^{-1}(x^2)$
j $y = \tan\left(2x - \frac{\pi}{2}\right)$	k $y = \tan^{-1}(2x + 1)$	l $y = \tan(x^2)$

6 Simplify each of the following expressions, in an exact form:

a $\cos\left(\sin^{-1}\left(\frac{4}{5}\right)\right)$ **b** $\tan\left(\cos^{-1}\left(\frac{5}{13}\right)\right)$ **c** $\cos\left(\tan^{-1}\left(\frac{7}{24}\right)\right)$

d $\tan\left(\sin^{-1}\left(\frac{40}{41}\right)\right)$ **e** $\tan\left(\cos^{-1}\left(\frac{1}{2}\right)\right)$ **f** $\sin\left(\cos^{-1}\left(\frac{2}{3}\right)\right)$

g $\sin(\tan^{-1}(-2))$ **h** $\cos\left(\sin^{-1}\left(\frac{3}{7}\right)\right)$ **i** $\sin(\tan^{-1} 0.7)$

7 Let $\sin \alpha = \frac{3}{5}$ and $\sin \beta = \frac{5}{13}$, where $\alpha \in \left[0, \frac{\pi}{2}\right]$ and $\beta \in \left[0, \frac{\pi}{2}\right]$.

a Find:

i $\cos \alpha$

ii $\cos \beta$

b Use a compound angle formula to show that:

i $\sin^{-1}\left(\frac{3}{5}\right) - \sin^{-1}\left(\frac{5}{13}\right) = \sin^{-1}\left(\frac{16}{65}\right)$

ii $\sin^{-1}\left(\frac{3}{5}\right) + \sin^{-1}\left(\frac{5}{13}\right) = \cos^{-1}\left(\frac{33}{65}\right)$

Example 13

8 Given that the domains of \sin and \cos are restricted to $\left[-\frac{\pi}{2}, \frac{\pi}{2}\right]$ and $[0, \pi]$ respectively, give the implied domain and range of each of the following:

a $y = \sin^{-1}(\cos x)$

b $y = \cos(\sin^{-1} x)$

c $y = \cos^{-1}(\sin(2x))$

d $y = \sin(-\cos^{-1} x)$

e $y = \cos(2 \sin^{-1} x)$

f $y = \tan^{-1}(\cos x)$

g $y = \cos(\tan^{-1} x)$

h $y = \sin(\tan^{-1} x)$

9 a Use a compound angle formula to show that $\tan^{-1}(3) - \tan^{-1}\left(\frac{1}{2}\right) = \frac{\pi}{4}$.

b Hence show that $\tan^{-1} x - \tan^{-1}\left(\frac{x-1}{x+1}\right) = \frac{\pi}{4}$ for $x > -1$.

10 Given that the domains of \sin and \cos are restricted to $\left[-\frac{\pi}{2}, \frac{\pi}{2}\right]$ and $[0, \pi]$ respectively, explain why each expression cannot be evaluated:

a $\cos(\arcsin(-0.5))$

b $\sin(\cos^{-1}(-0.2))$

c $\cos(\tan^{-1}(-1))$



3D Solution of equations

In Section 1A, we looked at the solution of equations involving sine, cosine and tangent. In this section, we introduce equations involving the reciprocal circular functions and the use of the double angle formulas. We also consider equations that are not able to be solved by analytic methods.

Example 14

Solve the equation $\sec x = 2$ for $x \in [0, 2\pi]$.

Solution

$$\sec x = 2$$

$$\therefore \cos x = \frac{1}{2}$$

We are looking for solutions in $[0, 2\pi]$:

$$x = \frac{\pi}{3} \quad \text{or} \quad x = 2\pi - \frac{\pi}{3}$$

$$\therefore x = \frac{\pi}{3} \quad \text{or} \quad x = \frac{5\pi}{3}$$

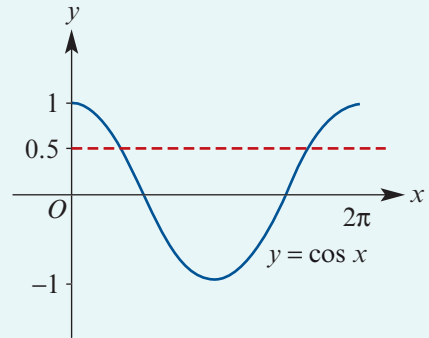

Example 15

Solve the equation $\operatorname{cosec}\left(2x - \frac{\pi}{3}\right) = \frac{-2\sqrt{3}}{3}$ for $x \in [0, 2\pi]$.

Solution

$$\operatorname{cosec}\left(2x - \frac{\pi}{3}\right) = \frac{-2\sqrt{3}}{3}$$

$$\text{implies} \quad \sin\left(2x - \frac{\pi}{3}\right) = \frac{-3}{2\sqrt{3}} = \frac{-\sqrt{3}}{2}$$

$$\text{Let } \theta = 2x - \frac{\pi}{3} \text{ where } \theta \in \left[-\frac{\pi}{3}, \frac{11\pi}{3}\right].$$

$$\text{Then} \quad \sin \theta = \frac{-\sqrt{3}}{2}$$

$$\therefore \theta = -\frac{\pi}{3}, \frac{4\pi}{3}, \frac{5\pi}{3}, \frac{10\pi}{3} \text{ or } \frac{11\pi}{3}$$

$$\therefore 2x - \frac{\pi}{3} = -\frac{\pi}{3}, \frac{4\pi}{3}, \frac{5\pi}{3}, \frac{10\pi}{3} \text{ or } \frac{11\pi}{3}$$

$$\therefore 2x = 0, \frac{5\pi}{3}, 2\pi, \frac{11\pi}{3} \text{ or } 4\pi$$

$$\therefore x = 0, \frac{5\pi}{6}, \pi, \frac{11\pi}{6} \text{ or } 2\pi$$

► General solution of trigonometric equations

We recall the following from Specialist Mathematics Year 11.

- For $a \in [-1, 1]$, the general solution of the equation $\cos x = a$ is

$$x = 2n\pi \pm \cos^{-1}(a), \quad \text{where } n \in \mathbb{Z}$$

- For $a \in \mathbb{R}$, the general solution of the equation $\tan x = a$ is

$$x = n\pi + \tan^{-1}(a), \quad \text{where } n \in \mathbb{Z}$$

- For $a \in [-1, 1]$, the general solution of the equation $\sin x = a$ is

$$x = 2n\pi + \sin^{-1}(a) \quad \text{or} \quad x = (2n + 1)\pi - \sin^{-1}(a), \quad \text{where } n \in \mathbb{Z}$$

Note: An alternative and more concise way to express the general solution of $\sin x = a$ is

$$x = n\pi + (-1)^n \sin^{-1}(a), \quad \text{where } n \in \mathbb{Z}.$$

Example 16

- Find all the values of x for which $\cot x = -1$.
- Find all the values of x for which $\sec\left(2x - \frac{\pi}{3}\right) = 2$.

Solution

- The period of the function $y = \cot x$ is π .

The solution of $\cot x = -1$ in $[0, \pi]$ is $x = \frac{3\pi}{4}$.

Therefore the solutions of the equation are

$$x = \frac{3\pi}{4} + n\pi \quad \text{where } n \in \mathbb{Z}$$

- First write the equation as

$$\cos\left(2x - \frac{\pi}{3}\right) = \frac{1}{2}$$

We now proceed as usual to find the general solution:

$$2x - \frac{\pi}{3} = 2n\pi \pm \cos^{-1}\left(\frac{1}{2}\right)$$

$$2x - \frac{\pi}{3} = 2n\pi \pm \frac{\pi}{3}$$

$$2x - \frac{\pi}{3} = 2n\pi + \frac{\pi}{3} \quad \text{or} \quad 2x - \frac{\pi}{3} = 2n\pi - \frac{\pi}{3}$$

$$2x = 2n\pi + \frac{2\pi}{3} \quad \text{or} \quad 2x = 2n\pi$$

$$\therefore \quad x = n\pi + \frac{\pi}{3} \quad \text{or} \quad x = n\pi \quad \text{where } n \in \mathbb{Z}$$

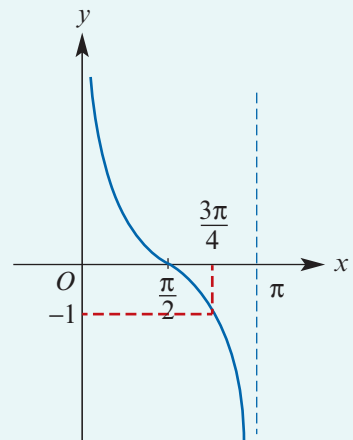

► Using identities to solve equations

The double angle formulas can be used to help solve trigonometric equations.

Example 17

Solve each of the following equations for $x \in [0, 2\pi]$:

a $\sin(4x) = \sin(2x)$

b $\cos x = \sin\left(\frac{x}{2}\right)$

Solution

a $\sin(4x) = \sin(2x)$

$$2 \sin(2x) \cos(2x) = \sin(2x)$$

$$\sin(2x)(2 \cos(2x) - 1) = 0 \quad \text{where } 2x \in [0, 4\pi]$$

Thus $\sin(2x) = 0$ or $2 \cos(2x) - 1 = 0$

i.e. $\sin(2x) = 0$ or $\cos(2x) = \frac{1}{2}$

$$\therefore 2x = 0, \pi, 2\pi, 3\pi, 4\pi \quad \text{or} \quad 2x = \frac{\pi}{3}, \frac{5\pi}{3}, \frac{7\pi}{3}, \frac{11\pi}{3}$$

$$x = 0, \frac{\pi}{2}, \pi, \frac{3\pi}{2}, 2\pi \quad \text{or} \quad x = \frac{\pi}{6}, \frac{5\pi}{6}, \frac{7\pi}{6}, \frac{11\pi}{6}$$

Hence $x = 0, \frac{\pi}{6}, \frac{\pi}{2}, \frac{5\pi}{6}, \pi, \frac{7\pi}{6}, \frac{3\pi}{2}, \frac{11\pi}{6}$ or 2π .

b $\cos x = \sin\left(\frac{x}{2}\right)$

$$1 - 2 \sin^2\left(\frac{x}{2}\right) = \sin\left(\frac{x}{2}\right)$$

$$2 \sin^2\left(\frac{x}{2}\right) + \sin\left(\frac{x}{2}\right) - 1 = 0 \quad \text{where } \frac{x}{2} \in [0, \pi]$$

Let $a = \sin\left(\frac{x}{2}\right)$. Then $a \in [0, 1]$. We have

$$2a^2 + a - 1 = 0$$

$$\therefore (2a - 1)(a + 1) = 0$$

$$\therefore 2a - 1 = 0 \quad \text{or} \quad a + 1 = 0$$

$$\therefore a = \frac{1}{2} \quad \text{or} \quad a = -1$$

Thus $a = \frac{1}{2}$, since $a \in [0, 1]$. We now have

$$\sin\left(\frac{x}{2}\right) = \frac{1}{2}$$

$$\therefore \frac{x}{2} = \frac{\pi}{6} \quad \text{or} \quad \frac{5\pi}{6}$$

$$\therefore x = \frac{\pi}{3} \quad \text{or} \quad \frac{5\pi}{3}$$

► Maximum and minimum values

We know that $-1 \leq \sin x \leq 1$ and $-1 \leq \cos x \leq 1$. This can be used to find the maximum and minimum values of trigonometric functions without using calculus.

For example:

- The function $y = 2 \sin x + 3$ has a maximum value of 5 and a minimum value of 1. The maximum value occurs when $\sin x = 1$ and the minimum value occurs when $\sin x = -1$.
- The function $y = \frac{1}{2 \sin x + 3}$ has a maximum value of 1 and a minimum value of $\frac{1}{5}$.



Example 18

Find the maximum and minimum values of:

a $\sin^2(2x) + 2 \sin(2x) + 2$ **b** $\frac{1}{\sin^2(2x) + 2 \sin(2x) + 2}$

Solution

a Let $a = \sin(2x)$. Then

$$\begin{aligned} \sin^2(2x) + 2 \sin(2x) + 2 &= a^2 + 2a + 2 \\ &= (a + 1)^2 + 1 \\ &= (\sin(2x) + 1)^2 + 1 \end{aligned}$$

Now $-1 \leq \sin(2x) \leq 1$.

Therefore the maximum value is 5 and the minimum value is 1.

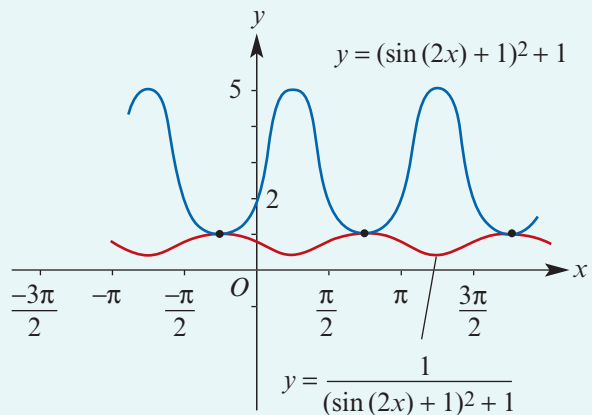

- b** Note that $\sin^2(2x) + 2 \sin(2x) + 2 > 0$ for all x . Thus its reciprocal also has this property. A local maximum for the original function yields a local minimum for the reciprocal. A local minimum for the original function yields a local maximum for the reciprocal. Hence the maximum value is 1 and the minimum value is $\frac{1}{5}$.

Using the TI-Nspire

- To find the x -values for which the maximum occurs, use **menu** > **Calculus** > **Function Maximum**. The restriction is chosen to give particular solutions.
- Use one of these x -values to find the maximum value of the expression.
- Similarly, to find the x -values for which the minimum occurs, use **menu** > **Calculus** > **Function Minimum**.

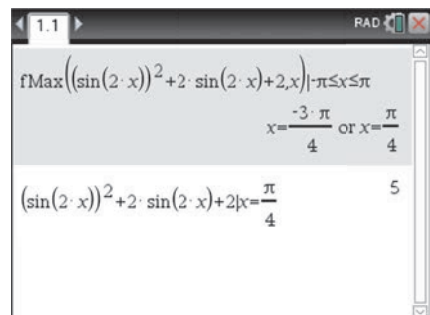

Using the Casio ClassPad

- In $\sqrt{\square}$, enter and highlight $(\sin(2x))^2 + 2\sin(2x) + 2$.
- To find the maximum value, select **Interactive** > **Calculation** > **fMax**.
- Enter the domain: start at 0; end at π .

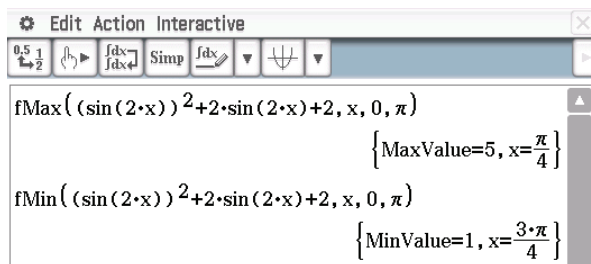

Note: The minimum value can be found similarly by choosing **fMin**.

► Using a CAS calculator to obtain approximate solutions

Many equations involving the circular functions cannot be solved using analytic techniques. A CAS calculator can be used to solve such equations numerically.

Example 19

Find the solutions of the equation $2\sin(3x) = x$, correct to three decimal places.

Solution

The graphs of $y = 2\sin(3x)$ and $y = x$ are plotted using a CAS calculator.

The solutions are $x = 0$, $x \approx 0.893$ and $x \approx -0.893$.

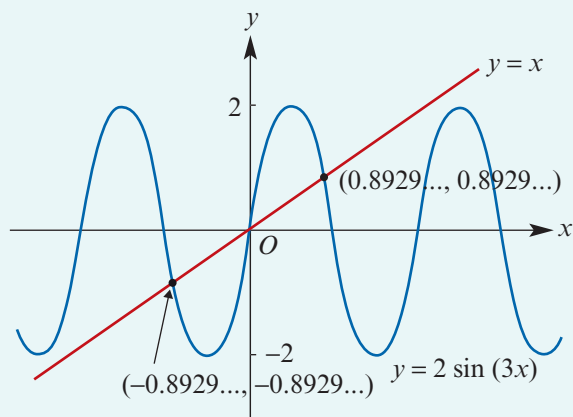

Exercise 3D

Skillsheet

1 Solve each of the following equations for $x \in [0, 2\pi]$:

a $\operatorname{cosec} x = -2$

b $\operatorname{cosec}\left(x - \frac{\pi}{4}\right) = -2$

c $3 \sec x = 2\sqrt{3}$

d $\operatorname{cosec}(2x) + 1 = 2$

e $\cot x = -\sqrt{3}$

f $\cot\left(2x - \frac{\pi}{3}\right) = -1$

2 Solve each of the following equations, giving solutions in the interval $[0, 2\pi]$:

a $\sin x = 0.5$

b $\cos x = \frac{-\sqrt{3}}{2}$

c $\tan x = \sqrt{3}$

d $\cot x = -1$

e $\sec x = -2$

f $\operatorname{cosec} x = -\sqrt{2}$

Example 14, 15

Example 16 3 Find all the solutions to each of the following equations:

a $\sin x = \frac{1}{\sqrt{2}}$

b $\sec x = 1$

c $\cot x = \sqrt{3}$

d $\operatorname{cosec}\left(2x - \frac{\pi}{3}\right) = 2$

e $\operatorname{cosec}\left(3x - \frac{\pi}{3}\right) = \frac{2\sqrt{3}}{3}$

f $\sec\left(3x - \frac{\pi}{6}\right) = \frac{2\sqrt{3}}{3}$

g $\cot\left(2x - \frac{\pi}{6}\right) = \sqrt{3}$

h $\cot\left(2x - \frac{\pi}{4}\right) = -1$

i $\operatorname{cosec}\left(2x - \frac{\pi}{4}\right) = 1$

4 Solve each of the following in the interval $[-\pi, \pi]$, giving the answers correct to two decimal places:

a $\sec x = 2.5$

b $\operatorname{cosec} x = -5$

c $\cot x = 0.6$

Example 17 5 Solve each of the following equations for $x \in [0, 2\pi]$:

a $\cos^2 x - \cos x \sin x = 0$

b $\sin(2x) = \sin x$

c $\sin(2x) = \cos x$

d $\sin(8x) = \cos(4x)$

e $\cos(2x) = \cos x$

f $\cos(2x) = \sin x$

g $\sec^2 x + \tan x = 1$

h $\tan x(1 + \cot x) = 0$

i $\cot x + 3 \tan x = 5 \operatorname{cosec} x$

j $\sin x + \cos x = 1$

Example 18 6 Find the maximum and minimum values of each of the following:

a $2 + \sin \theta$

b $\frac{1}{2 + \sin \theta}$

c $\sin^2 \theta + 4$

d $\frac{1}{\sin^2 \theta + 4}$

e $\cos^2 \theta + 2 \cos \theta$

f $\cos^2 \theta + 2 \cos \theta + 6$

Example 19 7 Using a CAS calculator, find the coordinates of the points of intersection for the graphs of the following pairs of functions. (Give values correct to two decimal places.)

a $y = 2x$ and $y = 3 \sin(2x)$

b $y = x$ and $y = 2 \sin(2x)$

c $y = 3 - x$ and $y = \cos x$

d $y = x$ and $y = \tan x$, $x \in [0, 2\pi]$

8 Let $a \in [-1, 1]$ with $a \neq -1$. Consider the equation $\cos x = a$ for $x \in [0, 2\pi]$. If q is one of the solutions, find the second solution in terms of q .

9 Let $\sin \alpha = a$ where $\alpha \in \left(0, \frac{\pi}{2}\right)$. Find, in terms of α , two values of x in $[0, 2\pi]$ which satisfy each of the following equations:

a $\sin x = -a$

b $\cos x = a$

10 Let $\sec \beta = b$ where $\beta \in \left(\frac{\pi}{2}, \pi\right)$. Find, in terms of β , two values of x in $[-\pi, \pi]$ which satisfy each of the following equations:

a $\sec x = -b$

b $\operatorname{cosec} x = b$

11 Let $\tan \gamma = c$ where $\gamma \in \left(\pi, \frac{3\pi}{2}\right)$. Find, in terms of γ , two values of x in $[0, 2\pi]$ which satisfy each of the following equations:

a $\tan x = -c$

b $\cot x = c$

- 12** Solve, correct to two decimal places, the equation $\sin^2 \theta = \frac{\theta}{\pi}$ for $\theta \in [0, \pi]$.
- 13** Find the value of x , correct to two decimal places, such that $\tan^{-1} x = 4x - 5$.
- 14** A curve on a light rail track is an arc of a circle of length 300 m and the straight line joining the two ends of the curve is 270 m long.
- a** Show that, if the arc subtends an angle of $2\theta^\circ$ at the centre of the circle, then θ is a solution of the equation $\sin \theta^\circ = \frac{\pi}{200}\theta^\circ$.
- b** Solve this equation for θ , correct to two decimal places.
- 15** Solve, correct to two decimal places, the equation $\tan x = \frac{1}{x}$ for $x \in [0, \pi]$.
- 16** The area of a segment of a circle is given by the equation $A = \frac{1}{2}r^2(\theta - \sin \theta)$, where θ is the angle subtended at the centre of the circle. If the radius is 6 cm and the area of the segment is 18 cm^2 , find the value of θ correct to two decimal places.

- 17** Two tangents are drawn from a point so that the area of the shaded region is equal to the area of the remaining region of the circle.

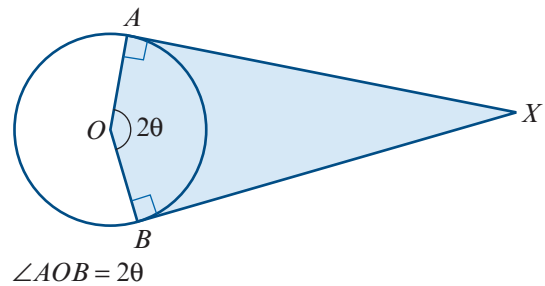

- a** Show that θ satisfies the equation $\tan \theta = \pi - \theta$.
- b** Solve for θ , giving the answer correct to three decimal places.

- 18** Two particles A and B move in a straight line. At time t , their positions relative to a point O are given by

$$x_A = 0.5 \sin t \quad \text{and} \quad x_B = 0.25t^2 + 0.05t$$

Find the times at which their positions are the same, and give this position. (Distances are measured in centimetres and time in seconds.)

- 19** A string is wound around a disc and a horizontal length of the string AB is 20 cm long. The radius of the disc is 10 cm. The string is then moved so that the end of the string, B' , is moved to a point at the same level as O , the centre of the circle. The line $B'P$ is a tangent to the circle.

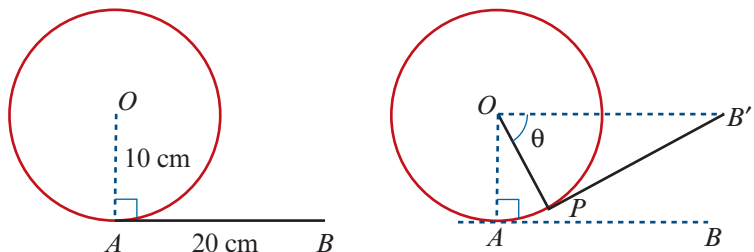

- a** Show that θ satisfies the equation $\frac{\pi}{2} - \theta + \tan \theta = 2$.
- b** Find the value of θ , correct to two decimal places, which satisfies this equation.



Chapter summary



Reciprocal circular functions

■ Definitions

$$\operatorname{cosec} x = \frac{1}{\sin x} \quad \text{provided } \sin x \neq 0$$

$$\sec x = \frac{1}{\cos x} \quad \text{provided } \cos x \neq 0$$

$$\cot x = \frac{\cos x}{\sin x} \quad \text{provided } \sin x \neq 0$$

■ Symmetry properties

$$\sec(\pi - x) = -\sec x$$

$$\operatorname{cosec}(\pi - x) = \operatorname{cosec} x$$

$$\cot(\pi - x) = -\cot x$$

$$\sec(\pi + x) = -\sec x$$

$$\operatorname{cosec}(\pi + x) = -\operatorname{cosec} x$$

$$\cot(\pi + x) = \cot x$$

$$\sec(2\pi - x) = \sec x$$

$$\operatorname{cosec}(2\pi - x) = -\operatorname{cosec} x$$

$$\cot(2\pi - x) = -\cot x$$

$$\sec(-x) = \sec x$$

$$\operatorname{cosec}(-x) = -\operatorname{cosec} x$$

$$\cot(-x) = -\cot x$$

■ Complementary properties

$$\sec\left(\frac{\pi}{2} - x\right) = \operatorname{cosec} x$$

$$\operatorname{cosec}\left(\frac{\pi}{2} - x\right) = \sec x$$

$$\cot\left(\frac{\pi}{2} - x\right) = \tan x$$

$$\tan\left(\frac{\pi}{2} - x\right) = \cot x$$

■ Pythagorean identities

$$\sin^2 x + \cos^2 x = 1$$

$$1 + \cot^2 x = \operatorname{cosec}^2 x$$

$$1 + \tan^2 x = \sec^2 x$$

Compound angle formulas

$$\blacksquare \cos(x + y) = \cos x \cos y - \sin x \sin y$$

$$\blacksquare \cos(x - y) = \cos x \cos y + \sin x \sin y$$

$$\blacksquare \sin(x + y) = \sin x \cos y + \cos x \sin y$$

$$\blacksquare \sin(x - y) = \sin x \cos y - \cos x \sin y$$

$$\blacksquare \tan(x + y) = \frac{\tan x + \tan y}{1 - \tan x \tan y}$$

$$\blacksquare \tan(x - y) = \frac{\tan x - \tan y}{1 + \tan x \tan y}$$

Double angle formulas

$$\blacksquare \cos(2x) = \cos^2 x - \sin^2 x$$

$$\blacksquare \sin(2x) = 2 \sin x \cos x$$

$$\blacksquare \tan(2x) = \frac{2 \tan x}{1 - \tan^2 x}$$

$$= 1 - 2 \sin^2 x$$

$$= 2 \cos^2 x - 1$$

Inverse circular functions

■ Inverse sine (arcsin)

$\sin^{-1}: [-1, 1] \rightarrow \mathbb{R}$, $\sin^{-1} x = y$,
where $\sin y = x$ and $y \in \left[-\frac{\pi}{2}, \frac{\pi}{2}\right]$

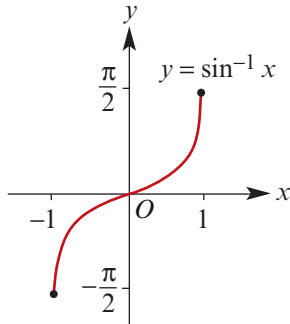

■ Inverse cosine (arccos)

$\cos^{-1}: [-1, 1] \rightarrow \mathbb{R}$, $\cos^{-1} x = y$,
where $\cos y = x$ and $y \in [0, \pi]$

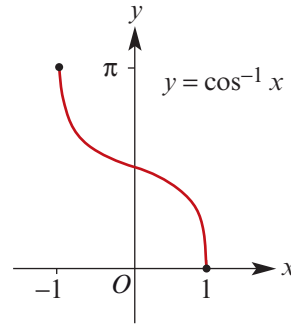

■ Inverse tangent (arctan)

$\tan^{-1}: \mathbb{R} \rightarrow \mathbb{R}$, $\tan^{-1} x = y$,
where $\tan y = x$ and $y \in \left(-\frac{\pi}{2}, \frac{\pi}{2}\right)$

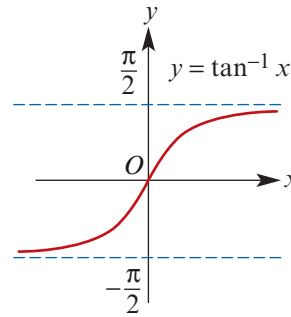

Short-answer questions

- If θ is an acute angle and $\cos \theta = \frac{4}{5}$, find:
 - $\cos(2\theta)$
 - $\sin(2\theta)$
 - $\tan(2\theta)$
 - $\operatorname{cosec} \theta$
 - $\cot \theta$
- Solve each of the following equations for $-\pi < x \leq 2\pi$:
 - $\sin(2x) = \sin x$
 - $\cos x - 1 = \cos(2x)$
 - $\sin(2x) = 2 \cos x$
 - $\sin^2 x \cos^3 x = \cos x$
 - $\sin^2 x - \frac{1}{2} \sin x - \frac{1}{2} = 0$
 - $2 \cos^2 x - 3 \cos x + 1 = 0$
- Solve each of the following equations for $0 \leq \theta \leq 2\pi$, giving exact answers:
 - $2 - \sin \theta = \cos^2 \theta + 7 \sin^2 \theta$
 - $\sec(2\theta) = 2$
 - $\frac{1}{2}(5 \cos \theta - 3 \sin \theta) = \sin \theta$
 - $\sec \theta = 2 \cos \theta$
- Find the exact value of each of the following:
 - $\sin\left(\frac{5\pi}{3}\right)$
 - $\operatorname{cosec}\left(-\frac{5\pi}{3}\right)$
 - $\sec\left(\frac{7\pi}{3}\right)$
 - $\operatorname{cosec}\left(\frac{5\pi}{6}\right)$
 - $\cot\left(-\frac{3\pi}{4}\right)$
 - $\cot\left(-\frac{\pi}{6}\right)$

- 5 Given that $\tan \alpha = p$, where α is an acute angle, find each of the following in terms of p :
- a** $\tan(-\alpha)$ **b** $\tan(\pi - \alpha)$ **c** $\tan\left(\frac{\pi}{2} - \alpha\right)$ **d** $\tan\left(\frac{3\pi}{2} + \alpha\right)$ **e** $\tan(2\pi - \alpha)$
- 6 Find:
- a** $\sin^{-1}\left(\frac{\sqrt{3}}{2}\right)$ **b** $\cos\left(\cos^{-1}\left(\frac{1}{2}\right)\right)$ **c** $\cos^{-1}\left(\cos\left(\frac{2\pi}{3}\right)\right)$
- d** $\cos^{-1}\left(\cos\left(\frac{4\pi}{3}\right)\right)$ **e** $\cos\left(\sin^{-1}\left(-\frac{1}{2}\right)\right)$ **f** $\cos(\tan^{-1}(-1))$
- 7 Sketch the graph of each of the following functions, stating the maximal domain and range of each:
- a** $y = 2 \tan^{-1} x$ **b** $y = \sin^{-1}(3 - x)$ **c** $y = 3 \cos^{-1}(2x + 1)$
- d** $y = -\cos^{-1}(2 - x)$ **e** $y = 2 \tan^{-1}(1 - x)$



Multiple-choice questions



- 1 Which of the following is the graph of the function $y = \cos^{-1}(x)$?

A

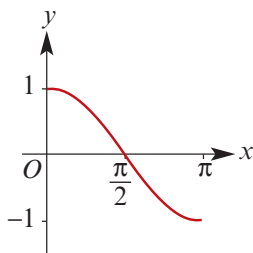

B

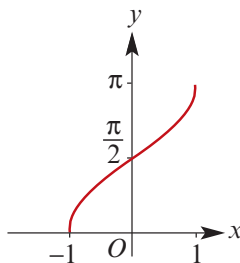

C

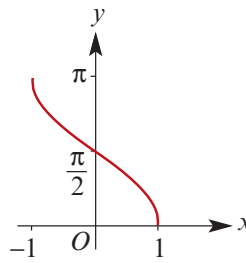

D

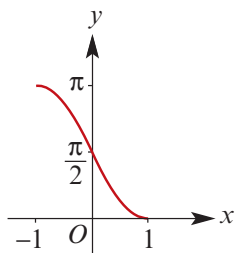

E

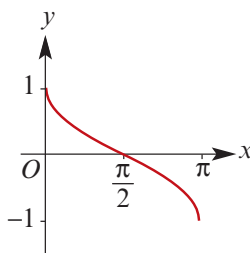

- 2 If $\cos x = \frac{-2}{3}$ and $2\pi < x < 3\pi$, then the exact value of $\sin x$ is

A $2\pi + \frac{\sqrt{5}}{3}$

B $2\pi - \frac{\sqrt{5}}{3}$

C $\frac{\sqrt{5}}{3}$

D $-\frac{\sqrt{5}}{3}$

E $\frac{5}{9}$

- 3 Given that $\cos(x) = \frac{-1}{10}$ and $x \in \left(\frac{\pi}{2}, \pi\right)$, the value of $\cot(x)$ is

A $\frac{10}{3\sqrt{11}}$

B $3\sqrt{11}$

C $-3\sqrt{11}$

D $\frac{\sqrt{11}}{33}$

E $-\frac{\sqrt{11}}{33}$

- 4 The graph of the function $y = 2 + \sec(3x)$, for $x \in \left(-\frac{\pi}{6}, \frac{7\pi}{6}\right)$, has stationary points at
- A** $x = \frac{\pi}{3}, \pi$ **B** $x = \frac{\pi}{6}, \frac{\pi}{2}, \frac{5\pi}{6}$ **C** $x = \frac{\pi}{2}$
- D** $x = 0, \frac{\pi}{3}, \frac{2\pi}{3}, \pi$ **E** $x = 0, \frac{2\pi}{3}$
- 5 If $\sin x = \frac{-1}{3}$, then the possible values of $\cos x$ are
- A** $\frac{-2\sqrt{2}}{3}, \frac{2\sqrt{2}}{3}$ **B** $\frac{-2}{3}, \frac{2}{3}$ **C** $\frac{-8}{9}, \frac{8}{9}$ **D** $\frac{-\sqrt{2}}{3}, \frac{\sqrt{2}}{3}$ **E** $\frac{-1}{2}, \frac{1}{2}$
- 6 The maximal domain of $y = \cos^{-1}(1 - 5x)$ is given by
- A** $\left[0, \frac{2}{5}\right]$ **B** $\left[\frac{1-\pi}{5}, \frac{1}{5}\right]$ **C** $[-1, 1]$ **D** $\left(0, \frac{2}{5}\right)$ **E** $\left[-\frac{1}{5}, \frac{1}{5}\right]$
- 7 $(1 + \tan x)^2 + (1 - \tan x)^2$ is equal to
- A** $2 + \tan x + 2 \tan(2x)$ **B** 2 **C** $-4 \tan x$ **D** $2 + \tan(2x)$ **E** $2 \sec^2 x$
- 8 The number of solutions of $\cos^2(3x) = \frac{1}{4}$, given that $0 \leq x \leq \pi$, is
- A** 1 **B** 2 **C** 3 **D** 6 **E** 9
- 9 $\frac{\tan(2\theta)}{1 + \sec(2\theta)}$ equals
- A** $\tan(2\theta)$ **B** $\tan(2\theta) + 1$ **C** $\tan \theta + 1$ **D** $\sin(2\theta)$ **E** $\tan \theta$
- 10 If $\sin A = t$ and $\cos B = t$, where $\frac{\pi}{2} < A < \pi$ and $0 < B < \frac{\pi}{2}$, then $\cos(B + A)$ is equal to
- A** 0 **B** $\sqrt{1-t^2}$ **C** $2t^2 - 1$ **D** $1 - 2t^2$ **E** $-2t\sqrt{1-t^2}$



Extended-response questions

- 1 A horizontal rod is 1 m long. One end is hinged at A , and the other end rests on a support B . The rod can be rotated about A , with the other end taking the two positions B_1 and B_2 , which are x m and $2x$ m above the line AB respectively, where $x < 0.5$.

Let $\angle BAB_1 = \alpha$ and $\angle BAB_2 = \beta$.

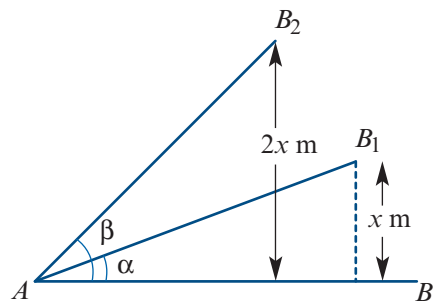

- a** Find each of the following in terms of x :

i $\sin \alpha$ **ii** $\cos \alpha$ **iii** $\tan \alpha$ **iv** $\sin \beta$ **v** $\cos \beta$ **vi** $\tan \beta$

- b** Using the results of **a**, find:

i $\sin(\beta - \alpha)$ **ii** $\cos(\beta - \alpha)$ **iii** $\tan(\beta - \alpha)$
iv $\tan(2\alpha)$ **v** $\sin(2\alpha)$ **vi** $\cos(2\alpha)$

- c** If $x = 0.3$, find the magnitudes of $\angle B_2AB_1$ and 2α , correct to two decimal places.

- 2 a** On the one set of axes, sketch the graphs of the following for $x \in (0, \pi) \cup (\pi, 2\pi)$:
- i** $y = \operatorname{cosec}(x)$ **ii** $y = \cot(x)$ **iii** $y = \operatorname{cosec}(x) - \cot(x)$
- b i** Show that $\operatorname{cosec} x - \cot x > 0$ for all $x \in (0, \pi)$, and hence that $\operatorname{cosec} x > \cot x$ for all $x \in (0, \pi)$.
- ii** Show that $\operatorname{cosec} x - \cot x < 0$ for all $x \in (\pi, 2\pi)$, and hence that $\operatorname{cosec} x < \cot x$ for all $x \in (\pi, 2\pi)$.
- c** On separate axes, sketch the graph of $y = \cot\left(\frac{x}{2}\right)$ for $x \in (0, 2\pi)$ and the graph of $y = \operatorname{cosec}(x) + \cot(x)$ for $x \in (0, 2\pi) \setminus \{\pi\}$.
- d i** Prove that $\operatorname{cosec} \theta + \cot \theta = \cot\left(\frac{\theta}{2}\right)$ where $\sin \theta \neq 0$.
- ii** Use this result to find $\cot\left(\frac{\pi}{8}\right)$ and $\cot\left(\frac{\pi}{12}\right)$.
- iii** Use the result $1 + \cot^2\left(\frac{\pi}{8}\right) = \operatorname{cosec}^2\left(\frac{\pi}{8}\right)$ to find the exact value of $\sin\left(\frac{\pi}{8}\right)$.
- e** Use the result of **d** to show that $\operatorname{cosec}(\theta) + \operatorname{cosec}(2\theta) + \operatorname{cosec}(4\theta)$ can be expressed as the difference of two cotangents.

- 3 a** $ABCD$ is a rectangle with diagonal AC of length 10 units.

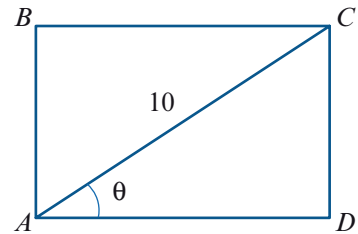

- i** Find the area of the rectangle in terms of θ .
- ii** Sketch the graph of R against θ , where R is the area of the rectangle in square units, for $\theta \in \left(0, \frac{\pi}{2}\right)$.
- iii** Find the maximum value of R . (Do not use calculus.)
- iv** Find the value of θ for which this maximum occurs.

- b** $ABCDEFGH$ is a cuboid with $\angle GAC = \frac{\theta}{2}$, $\angle CAD = \theta$ and $AC = 10$.

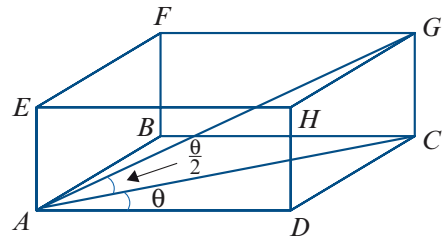

- i** Show that the volume, V , of the cuboid is given by
- $$V = 1000 \cos \theta \sin \theta \tan\left(\frac{\theta}{2}\right)$$
- ii** Find the values of a and b such that $V = a \sin^2\left(\frac{\theta}{2}\right) + b \sin^4\left(\frac{\theta}{2}\right)$.
- iii** Let $p = \sin^2\left(\frac{\theta}{2}\right)$. Express V as a quadratic in p .
- iv** Find the possible values of p for $0 < \theta < \frac{\pi}{2}$.
- v** Sketch the graphs of V against θ and V against p with the help of a calculator.
- vi** Find the maximum volume of the cuboid and the values of p and θ for which this occurs. (Determine the maximum through the quadratic found in **b iii**.)
- c** Now assume that the cuboid satisfies $\angle CAD = \theta$, $\angle GAC = \theta$ and $AC = 10$.
- i** Find V in terms of θ .
- ii** Sketch the graph of V against θ .
- iii** Discuss the relationship between V and θ using the graph of **c ii**.

- 4** $ABCDE$ is a pentagon inscribed in a circle with $AB = BC = CD = DE = 1$ and $\angle BOA = 2\theta$. The centre of the circle is O . Let $p = AE$.

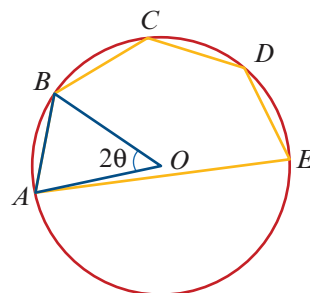

- a** Show that $p = \frac{\sin(4\theta)}{\sin \theta}$.
- b** Express p as a function of $\cos \theta$.
Let $x = \cos \theta$.
- c**
- If $p = \sqrt{3}$, show that $8x^3 - 4x - \sqrt{3} = 0$.
 - Show that $\frac{\sqrt{3}}{2}$ is a solution to the equation and that it is the only real solution.
 - Find the value of θ for which $p = \sqrt{3}$.
 - Find the radius of the circle.
- d** Using a CAS calculator, sketch the graph of p against θ for $\theta \in \left(0, \frac{\pi}{4}\right]$.
- e** If $A = E$, find the value of θ .
- f**
- If $AE = 1$, show that $8x^3 - 4x - 1 = 0$.
 - Hence show that $\frac{1}{4}(\sqrt{5} + 1) = \cos\left(\frac{\pi}{5}\right)$.
- 5**
- Prove that $\tan x + \cot x = 2 \operatorname{cosec}(2x)$ for $\sin(2x) \neq 0$.
 - Solve the equation $\tan x = \cot x$ for x .
 - On the one set of axes, sketch the graphs of $y = \tan x$, $y = \cot x$ and $y = 2 \operatorname{cosec}(2x)$ for $x \in (0, 2\pi)$.
 - Prove that $\cot(2x) + \tan x = \operatorname{cosec}(2x)$ for $\sin(2x) \neq 0$.
 - Solve the equation $\cot(2x) = \tan x$ for x .
 - On the one set of axes, sketch the graphs of $y = \cot(2x)$, $y = \tan x$ and $y = \operatorname{cosec}(2x)$ for $x \in (0, 2\pi)$.
- c**
- Prove that $\cot(mx) + \tan(nx) = \frac{\cos((m-n)x)}{\sin(mx)\cos(nx)}$, for all $m, n \in \mathbb{Z}$.
 - Hence show that $\cot(6x) + \tan(3x) = \operatorname{cosec}(6x)$.
- 6** Triangle ABE is isosceles with $AB = BE$, and triangle ACE is isosceles with $AC = AE = 1$.
- Find the magnitudes of $\angle BAE$, $\angle AEC$ and $\angle ACE$.
 - Hence find the magnitude of $\angle BAC$.
 - Show that $BD = 1 + \sin 18^\circ$.
 - Use triangle ABD to prove that

$$\cos 36^\circ = \frac{1 + \sin 18^\circ}{1 + 2 \sin 18^\circ}$$
 - Hence show that $4 \sin^2 18^\circ + 2 \sin 18^\circ - 1 = 0$.
 - Find $\sin 18^\circ$ in exact form.

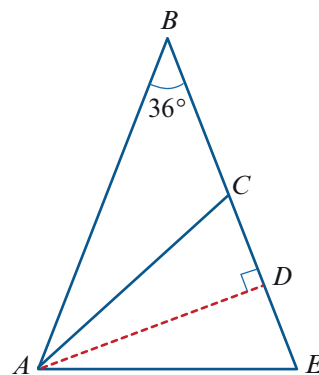

- 7** $VABCD$ is a right pyramid, where the base $ABCD$ is a rectangle with diagonal length $AC = 10$.

a First assume that $\angle CAD = \theta^\circ$ and $\angle VAX = \theta^\circ$.

- i** Show that the volume, V , of the pyramid is given by

$$V = \frac{500}{3} \sin^2 \theta$$

- ii** Sketch the graph of V against θ for $\theta \in (0, 90)$.

iii Comment on the graph.

b Now assume that $\angle CAD = \theta^\circ$ and $\angle VAX = \frac{\theta^\circ}{2}$.

- i** Show that the volume, V , of the pyramid is given by

$$V = \frac{1000}{3} \sin^2\left(\frac{\theta}{2}\right) \left(1 - 2 \sin^2\left(\frac{\theta}{2}\right)\right)$$

- ii** State the maximal domain of the function $V(\theta)$.

iii Let $a = \sin^2\left(\frac{\theta}{2}\right)$ and write V as a quadratic in a .

iv Hence find the maximum value of V and the value of θ for which this occurs.

- v** Sketch the graph of V against θ for the domain established in **b ii**.

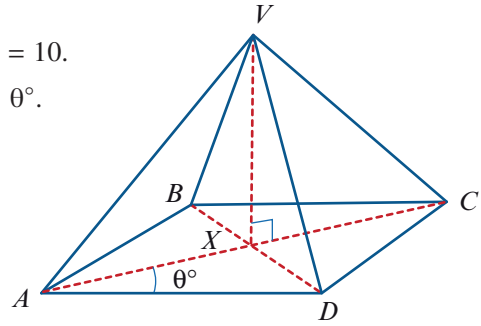

- 8** $VABCD$ is a right pyramid, where the base $ABCD$ is a rectangle with diagonal length $AC = 10$.

Assume that $\angle CAD = \theta^\circ$ and $AY = BY$.

a If $\angle VYX = \theta^\circ$, find:

- i** an expression for the volume of the pyramid in terms of θ
- ii** the maximum volume and the value of θ for which this occurs.

b If $\angle VYX = \frac{\theta^\circ}{2}$:

- i** show that $V = \frac{500}{3} \cos^2 \theta (1 - \cos \theta)$

ii state the implied domain for the function.

c Let $a = \cos \theta$. Then $V = \frac{500}{3} a^2 (1 - a)$. Use a CAS calculator to find the maximum value of V and the values of a and θ for which this maximum occurs.

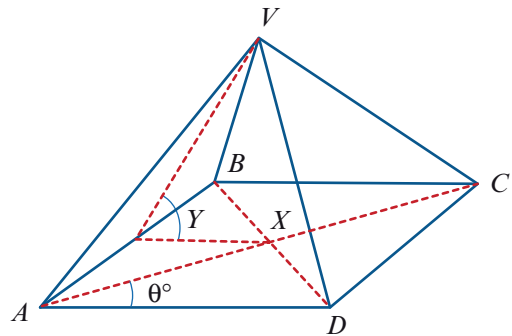

- 9** A camera is in a position x m from a point A . An object that is a metres in length is projected vertically upwards from A . When the object has moved b metres vertically up:

a Show that

$$\theta = \tan^{-1}\left(\frac{a+b}{x}\right) - \tan^{-1}\left(\frac{b}{x}\right)$$

b Use the result of **a** to show that

$$\tan \theta = \frac{ax}{x^2 + ba + b^2}$$

c If $\theta = \frac{\pi}{4}$, find:

- i** x in terms of a and b
- ii** x if $a = 2(1 + \sqrt{2})$ and $b = 1$

d If $a = 2(1 + \sqrt{2})$, $b = 1$ and $x = 1$, find an approximate value of θ .

e Using a CAS calculator, plot the graphs of θ against b and $\tan \theta$ against b for constant values of a and x as follows:

- i** $a = 1$, $x = 5$
- ii** $a = 1$, $x = 10$
- iii** $a = 1$, $x = 20$

f Comment on these graphs.

- 10** Points A , B and C lie on a circle with centre O and radius 1 as shown.

- a** Give reasons why triangle ACD is similar to triangle ABC .
- b** Give the coordinates of C in terms of circular functions applied to 2θ .
- c** **i** Find CA in terms of θ from triangle ABC .
- ii** Find CB in terms of θ from triangle ABC .

- d** Use the results of **b** and **c** to show that $\sin(2\theta) = 2 \sin \theta \cos \theta$.
- e** Use the results of **b** and **c** to show that $\cos(2\theta) = 2 \cos^2 \theta - 1$.

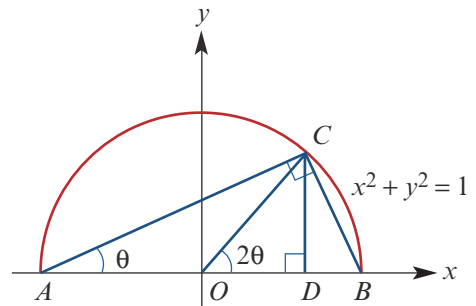
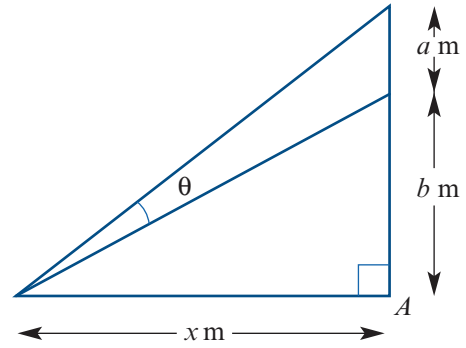

4

Revision of Chapters 1–3

4A Short-answer questions

- Express each of the following sets as an interval or a union of intervals:
 - $\{x : |x + 3| < 5\}$
 - $\{x : 2 - |x + 1| \geq 0\}$
 - $\{x : |3 - x| \geq 4\}$
- Let $f(x) = 4x - 3$ and $g(x) = x^2 + 2x$.
 - Find $f \circ g$.
 - Find $g \circ f$.
 - Find a transformation that takes the graph of $y = g(x)$ to the graph of $y = f(g(x))$.
 - Find a transformation that takes the graph of $y = g(x)$ to the graph of $y = g(f(x))$.
- Let $f: [a, \infty) \rightarrow \mathbb{R}$ with $f(x) = -(3x - 2)^2 + 3$, where a is the smallest real number such that the function f is one-to-one.
 - Find the value of a .
 - State the range of f .
 - Find f^{-1} and state the domain and range of f^{-1} .
 - Sketch the graphs of f and f^{-1} on the one set of axes.
- The inverse function of the linear function $f(x) = ax + b$ is $f^{-1}(x) = 4x - 6$. Find the values of a and b .
- Find the inverse function of each of the following functions:
 - $f(x) = 3x^{\frac{1}{3}} + 1$
 - $f(x) = (3x - 2)^3 + 4$
 - $f(x) = -2x^3 + 3$
- Given that $\sin\left(\frac{\pi}{12}\right) = \frac{-1 + \sqrt{3}}{2\sqrt{2}}$, find $\cos^2\left(\frac{\pi}{12}\right)$.
 - Given that $\cos\left(\frac{\pi}{5}\right) = \frac{1}{4}(1 + \sqrt{5})$, find:
 - $\sec\left(\frac{\pi}{5}\right)$
 - $\tan^2\left(\frac{\pi}{5}\right)$

- 7** Let $f(x) = 3 \arcsin(2x + 1) + 4$. State the implied domain and range of f .
- 8** Find the points of intersection of the graph of $y = \sec^2\left(\frac{\pi x}{3}\right)$ with the line $y = 2$ for $0 < x < 6$.
- 9** Find all real solutions of $4 \cos x = 2 \cot x$.
- 10** **a** Solve the equation $\sin(4x) = \cos(2x)$ for $0 \leq x \leq \pi$.
b Consider the graphs of $f(x) = \operatorname{cosec}(4x)$, $0 \leq x \leq \pi$, and $g(x) = \sec(2x)$, $0 \leq x \leq \pi$.
i Find the coordinates of the points of intersection of these two graphs.
ii Sketch these graphs on the same set of axes.
c On another set of axes, sketch the graph of $h(x) = 2 \arccos\left(\frac{x-2}{2}\right)$, clearly labelling the endpoints.
- 11** **a** Find the maximal domain and range of the function $y = a + b \arcsin(cx + d)$, where $a, b, c, d \in \mathbb{R}^+$.
b Sketch the graph of $y = 2\pi + 4 \arcsin(3x + 1)$.

4B Multiple-choice questions

- 1** If $\sin x = -\frac{1}{5}$, where $\pi \leq x \leq \frac{3\pi}{2}$, then $\tan x$ equals
A $\frac{\sqrt{6}}{12}$ **B** $\frac{1}{24}$ **C** $\frac{1}{4}$ **D** $-\frac{1}{24}$ **E** $\frac{-\sqrt{6}}{12}$
- 2** If $\cos x = a$, where $\frac{\pi}{2} \leq x \leq \pi$, then $\sin(x + \pi)$ equals
A $1 - a$ **B** $a - 1$ **C** $\sqrt{1 - a^2}$ **D** $-\sqrt{1 - a^2}$ **E** $1 + a$
- 3** The equation $\sin\left(2x + \frac{\pi}{3}\right) = -\frac{\sqrt{3}}{2}$, for $-\pi \leq x \leq \pi$, has
A 0 solutions **B** 1 solution **C** 2 solutions **D** 3 solutions **E** 4 solutions
- 4** The solutions of $\tan^2 x = 3$, for $0 \leq x \leq 2\pi$, are
A $\frac{\pi}{3}$ only **B** $\frac{\pi}{3}$ and $\frac{4\pi}{3}$ only **C** $\frac{\pi}{6}$ only
D $\frac{\pi}{6}$ and $\frac{7\pi}{6}$ only **E** $\frac{\pi}{3}$, $\frac{2\pi}{3}$, $\frac{4\pi}{3}$ and $\frac{5\pi}{3}$
- 5** The y-axis intercept of the graph of $y = 3 \tan\left(2x + \frac{5\pi}{6}\right)$ is
A $\left(0, -\frac{\sqrt{3}}{2}\right)$ **B** $\left(0, -\frac{\sqrt{2}}{2}\right)$ **C** $(0, -\sqrt{3})$ **D** $(0, \sqrt{2})$ **E** $\left(0, -\frac{\sqrt{3}}{3}\right)$

- 6** The x -axis intercept of the graph of $y = -2 \cos\left(\pi - \frac{x}{3}\right)$, $0 \leq x \leq 2\pi$, is
A $\frac{4\pi}{3}$ **B** $\frac{5\pi}{3}$ **C** $\frac{7\pi}{6}$ **D** $\frac{3\pi}{2}$ **E** $\frac{5\pi}{4}$
- 7** An asymptote of the graph of $y = 2 \tan\left(3x - \frac{\pi}{3}\right)$ is located at
A $x = \frac{\pi}{2}$ **B** $x = \frac{5\pi}{9}$ **C** $x = \frac{\pi}{18}$ **D** $x = \frac{\pi}{12}$ **E** $x = \frac{5\pi}{18}$
- 8** The asymptotes of the hyperbola $\frac{(x+1)^2}{9} - \frac{(y-2)^2}{16} = 1$ have equations
A $y = \frac{3}{4}x + \frac{8}{3}$ and $y = \frac{3}{4}x + \frac{2}{3}$ **B** $y = \frac{3}{4}x + \frac{10}{3}$ and $y = \frac{3}{4}x + \frac{2}{3}$
C $y = \frac{4}{3}x + \frac{10}{3}$ and $y = -\frac{4}{3}x + \frac{2}{3}$ **D** $y = \frac{4}{3}x + \frac{10}{3}$ and $y = -\frac{4}{3}x + \frac{10}{3}$
E $y = \frac{3}{4}x - \frac{10}{3}$ and $y = -\frac{3}{4}x + \frac{2}{3}$
- 9** A circle has a diameter with endpoints at $(4, -2)$ and $(-2, -2)$. The equation of the circle is
A $(x-1)^2 + (y-2)^2 = 3$ **B** $(x-1)^2 + (y+2)^2 = 3$ **C** $(x+1)^2 + (y-2)^2 = 6$
D $(x-1)^2 + (y+2)^2 = 9$ **E** $(x-1)^2 + (y+2)^2 = 6$
- 10** The ellipse shown has its centre on the x -axis. Its equation is
A $\frac{(x+2)^2}{9} + \frac{y^2}{16} = 1$
B $\frac{(x-2)^2}{9} + \frac{y^2}{16} = 1$
C $\frac{(x+2)^2}{3} + \frac{y^2}{4} = 1$
D $\frac{(x-2)^2}{3} + \frac{y^2}{4} = 1$
E $\frac{(x-2)^2}{9} - \frac{y^2}{16} = 1$

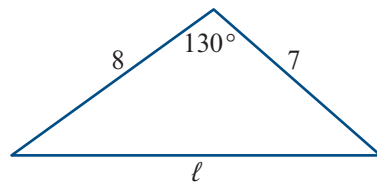
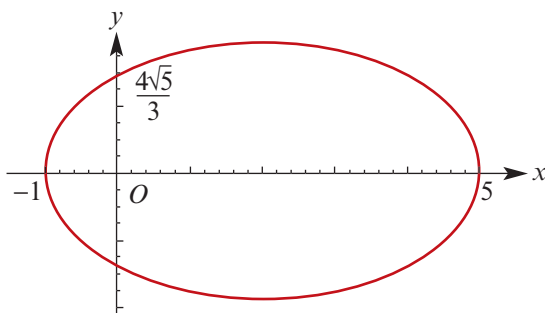

- 12** The ellipse with equation $\frac{x^2}{9} + \frac{y^2}{25} = 1$ has x -axis intercepts with coordinates
A $(-3, -5)$ and $(3, 5)$ **B** $(-5, -3)$ and $(5, 3)$ **C** $(0, -3)$ and $(0, 3)$
D $(-3, 0)$ and $(3, 0)$ **E** $(3, 0)$ and $(5, 0)$
- 13** The circle defined by the equation $x^2 + y^2 - 6x + 8y = 0$ has centre
A $(2, 4)$ **B** $(-5, 9)$ **C** $(4, -3)$ **D** $(3, -4)$ **E** $(6, -8)$
- 14** If the line $x = k$ is a tangent to the circle with equation $(x - 1)^2 + (y + 2)^2 = 1$, then k is equal to
A 1 or -2 **B** 1 or 3 **C** -1 or -3 **D** 0 or -2 **E** 0 or 2
- 15** The curve with equation $x^2 - 2x = y^2$ is
A an ellipse with centre $(1, 0)$ **B** a hyperbola with centre $(1, 0)$
C a circle with centre $(1, 0)$ **D** an ellipse with centre $(-1, 0)$
E a hyperbola with centre $(-1, 0)$
- 16** A curve is defined parametrically by the equations $x = 2 \cos(t)$ and $y = 2 \cos(2t)$. The Cartesian equation of the curve is
A $y = 2 + x^2$ **B** $y = x^2 - 2$ **C** $y = 2x$ **D** $y = x$ **E** $y = 2x^2 - 1$
- 17** A curve is defined parametrically by the equations $x = 2 \sec t$ and $y = 3 \tan t$. The point on the curve where $t = -\frac{\pi}{3}$ is
A $(4, 3\sqrt{3})$ **B** $(4, -3\sqrt{3})$ **C** $(4\sqrt{3}, -4)$ **D** $(-4, -3\sqrt{3})$ **E** $(4, -\frac{\sqrt{3}}{3})$
- 18** A curve is defined parametrically by the equations $x = 2e^t + 1$ and $y = 2e^{-2t}$. The Cartesian equation of the curve is
A $y = \frac{x-1}{4}$ **B** $y = 1 - x$ **C** $y = \frac{4}{x-1}$ **D** $y = \frac{8}{(x-1)^2}$ **E** $y = \frac{8}{x-1}$
- 19** The rule for the graph shown is
A $y = |x - 2| + 3$ **B** $y = |-x + 2| + 3$
C $y = |x + 2| + 3$ **D** $y = -|x - 2| + 3$
E $y = -|x + 2| + 3$

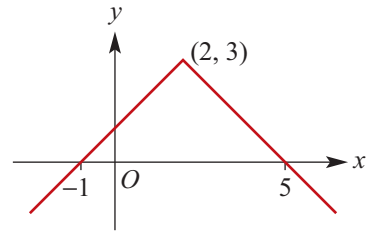

- 20** Let $f(x) = |x|$ and $g(x) = \sqrt{x-1}$. The maximal domain of f such that the composite function $g \circ f$ is defined is
A \mathbb{R} **B** \mathbb{R}^+ **C** $[-1, 1]$ **D** $[1, \infty)$ **E** $(-\infty, -1] \cup [1, \infty)$
- 21** Which one of the following functions is not a one-to-one function?
A $f: \mathbb{R}^+ \rightarrow \mathbb{R}, f(x) = x^2$ **B** $f: \mathbb{R} \rightarrow \mathbb{R}, f(x) = x^3$
C $f: \mathbb{R}^+ \rightarrow \mathbb{R}, f(x) = \sqrt{x}$ **D** $f: [0, \pi] \rightarrow \mathbb{R}, f(x) = \sin x$
E $f: [0, \pi] \rightarrow \mathbb{R}, f(x) = \cos x$

22 If $f(x) = 3x - 2$, for $x \in \mathbb{R}$, then $f^{-1}(x)$ equals

- A $\frac{1}{3x-2}$ B $3x+2$ C $\frac{1}{3}(x-2)$ D $3x+6$ E $\frac{1}{3}(x+2)$

23 Let $h: [a, 2] \rightarrow \mathbb{R}$ where $h(x) = 2x - x^2$. If a is the smallest real number such that h has an inverse function, h^{-1} , then a equals

- A -1 B 0 C 1 D -2 E $\frac{1}{2}$

24 The graph of the function with rule $y = f(x)$ is shown.

Which one of the following graphs is the graph of the inverse of f ?

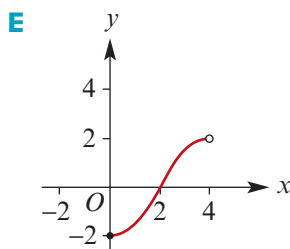
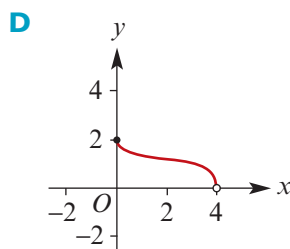
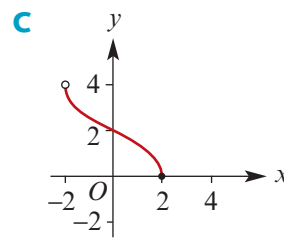
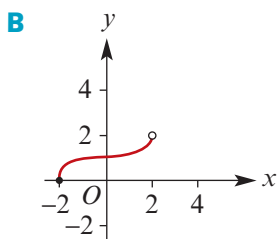
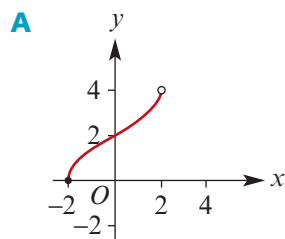
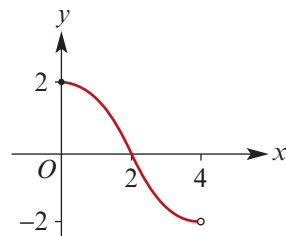

25 The inverse, f^{-1} , of the function $f: [2, 3] \rightarrow \mathbb{R}$, $f(x) = 2x - 4$ is

- A $f^{-1}: [0, 2] \rightarrow \mathbb{R}$, $f^{-1}(x) = \frac{x}{2} + 4$ B $f^{-1}: [3, 2] \rightarrow \mathbb{R}$, $f^{-1}(x) = \frac{x+4}{2}$
 C $f^{-1}: [2, 3] \rightarrow \mathbb{R}$, $f^{-1}(x) = \frac{1}{2x-4}$ D $f^{-1}: [0, 2] \rightarrow \mathbb{R}$, $f^{-1}(x) = \frac{1}{2x-4}$
 E $f^{-1}: [0, 2] \rightarrow \mathbb{R}$, $f^{-1}(x) = \frac{x+4}{2}$

26 The rule for the graph shown could be

- A $y = |x(x+4)|$ B $y = |x|(|x+4|)$
 C $y = \left|\frac{1}{4}x^2 + x\right|$ D $y = \frac{1}{4}|x|^2 + |x|$
 E $y = |1 - (x+2)^2|$

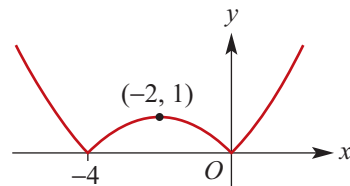

- 27** The function $g: [-a, a] \rightarrow \mathbb{R}$, $g(x) = 3 \sin(2x)$ has an inverse function. The maximum possible value of a is
A 3 **B** $\frac{\pi}{6}$ **C** $\frac{\pi}{3}$ **D** $\frac{\pi}{4}$ **E** $\frac{\pi}{2}$
- 28** The graph of a function f whose rule is $y = f(x)$ has exactly one asymptote, for which the equation is $y = 6$. The inverse function f^{-1} exists. The inverse function will have
A a horizontal asymptote with equation $y = 6$
B a vertical asymptote with equation $x = 6$
C a vertical asymptote with equation $x = -\frac{1}{6}$
D a horizontal asymptote with equation $y = -6$
E no asymptote
- 29** If $\tan \alpha = \frac{3}{4}$ and $\tan \beta = \frac{4}{3}$, where both α and β are acute, then $\sin(\alpha + \beta)$ equals
A $\frac{7}{5}$ **B** $\frac{24}{25}$ **C** $\frac{7}{25}$ **D** 0 **E** 1
- 30** $\cos^2 \theta + 3 \sin^2 \theta$ equals
A $2 + \cos \theta$ **B** $3 - 2 \cos(2\theta)$ **C** $2 - \cos \theta$
D $2 \cos(2\theta) - 1$ **E** none of these
- 31** $\cos^{-1}\left(-\frac{\sqrt{3}}{2}\right) - \sin^{-1}\left(-\frac{\sqrt{3}}{2}\right)$ equals
A $-\frac{5\pi}{6}$ **B** $-\frac{\pi}{2}$ **C** $-\frac{\pi}{6}$ **D** $\frac{\pi}{2}$ **E** $\frac{7\pi}{6}$
- 32** $\cos\left(\tan^{-1}(1) + \sin^{-1}\left(\frac{1}{\sqrt{2}}\right)\right)$ equals
A $\frac{\pi}{2}$ **B** 1 **C** 0 **D** $-\frac{1}{\sqrt{2}}$ **E** $-\frac{\sqrt{3}}{2}$
- 33** If $\cos x = -\frac{3}{5}$ and $\pi < x < \frac{3\pi}{2}$, then $\tan x$ is
A $\frac{4}{3}$ **B** $\frac{3}{4}$ **C** $-\frac{4}{5}$ **D** $-\frac{3}{5}$ **E** $\frac{9}{25}$
- 34** The maximal domain of $f(x) = \sin^{-1}(2x - 1)$ is
A $[-1, 1]$ **B** $(-1, 1)$ **C** $(0, 1)$ **D** $[0, 1]$ **E** $[-1, 0]$
- 35** The exact value of $\sin\left(\cos^{-1}\left(-\frac{1}{2}\right)\right)$ is
A $\frac{\sqrt{3}}{2}$ **B** $-\frac{1}{2}$ **C** 1 **D** $-\frac{\sqrt{3}}{2}$ **E** $\frac{1}{\sqrt{5}}$
- 36** If $\tan \theta = \frac{1}{3}$, then $\tan(2\theta)$ equals
A $\frac{3}{5}$ **B** $\frac{2}{3}$ **C** $\frac{3}{4}$ **D** $\frac{4}{5}$ **E** $\frac{4}{3}$

- 37** Which one of the following five expressions is not identical to any of the others?
A $\cos^4 \theta - \sin^4 \theta$ **B** $1 + \cos \theta$ **C** $\cos(2\theta)$ **D** $2 \cos^2\left(\frac{\theta}{2}\right)$ **E** $1 - \cos \theta$
- 38** If $\tan^{-1}\left(\frac{1}{2}\right) + \tan^{-1}\left(\frac{1}{3}\right) = \tan^{-1} x$, then x is
A 1 **B** $\frac{5}{6}$ **C** $\frac{5}{7}$ **D** $\frac{1}{5}$ **E** $\frac{1}{7}$
- 39** Which one of the following five expressions is not identical to any of the others?
A $\tan \theta + \cot \theta$ **B** $\operatorname{cosec}^2 \theta - \cot^2 \theta$ **C** 1
D $\operatorname{cosec} \theta \cot \theta$ **E** $2 \operatorname{cosec}(2\theta)$

4C Extended-response questions

- 1 a** For $f: [5, \infty) \rightarrow \mathbb{R}$, $f(x) = \sqrt{x-3}$:
- Sketch the graph of $y = f(x)$ for $x \in [5, \infty)$.
 - State the range of f .
 - Find f^{-1} .
- b** For $h: [4, \infty) \rightarrow \mathbb{R}$, $h(x) = \sqrt{x-p}$ with inverse function h^{-1} that has domain $[1, \infty)$:
- Find p .
 - Find the rule for h^{-1} .
 - Sketch the graphs of $y = h(x)$ and $y = h^{-1}(x)$ on the one set of axes.
- 2** Let $f: (0, \pi) \rightarrow \mathbb{R}$ with $f(x) = \sin x$ and $g: [1, \infty) \rightarrow \mathbb{R}$ with $g(x) = \frac{1}{x}$.
- Find the range of f .
 - Find the range of g .
 - Give a reason why $f \circ g$ is defined and find $f \circ g(x)$.
 - State, with reason, whether $g \circ f$ is defined.
 - Find g^{-1} , giving its domain and range.
 - Give a reason why $g^{-1} \circ f$ is defined and find $g^{-1} \circ f(x)$. Also state the domain and range of this function.
- 3 a** On the same set of axes, sketch the graphs of the following functions:
- $f(x) = \cos x$, $-\pi < x < \pi$
 - $g(x) = \tan^{-1} x$, $-\pi < x < \pi$
- b** Find correct to two decimal places:
- $\tan^{-1}\left(\frac{\pi}{4}\right)$
 - $\cos 1$
- c** Hence show that the graphs of $y = f(x)$ and $y = g(x)$ intersect in the interval $\left[\frac{\pi}{4}, 1\right]$.
- d** Using a CAS calculator, find the solution of $f(x) = g(x)$ correct to two decimal places.
- e** Show that $f(x) = g(x)$ has no other real solutions.

4 a On the same set of axes, sketch the graphs of the following functions:

i $f(x) = \sin x, -\frac{\pi}{2} < x < \frac{\pi}{2}$

ii $g(x) = \cos^{-1} x, -1 < x < 1$

b Find correct to two decimal places:

i $\sin\left(\frac{1}{2}\right)$ **ii** $\cos^{-1}\left(\frac{\pi}{4}\right)$

c Hence show that the graphs of $y = f(x)$ and $y = g(x)$ intersect in the interval $\left[\frac{1}{2}, \frac{\pi}{4}\right]$.

d Using a CAS calculator, find the coordinates of the point(s) of intersection of the graphs, correct to three decimal places.

5 The cross-section of a water channel is defined by the function

$$f(x) = a \sec\left(\frac{\pi}{15}x\right) + d$$

The top of the channel is level with the ground and is 10 m wide. At its deepest point, the channel is 5 m deep.

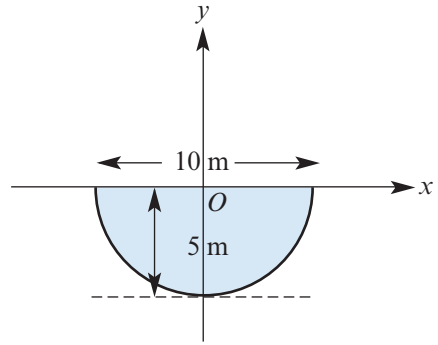

a Find a and d .

b Find, correct to two decimal places:

i the depth of the water when the width of the water surface is 7 m

ii the width of the water surface when the water is 2.5 m deep

6 An archway, which appears as shown, has been designed using a function of the form

$$g: [0, 6] \rightarrow \mathbb{R},$$

$$g(x) = a \sec(bx + c) + d$$

The graph of g is a transformation of the graph of

$$f: \left[-\frac{\pi}{3}, \frac{\pi}{3}\right] \rightarrow \mathbb{R}, f(x) = \sec x$$

Find the values of a , b , c and d .

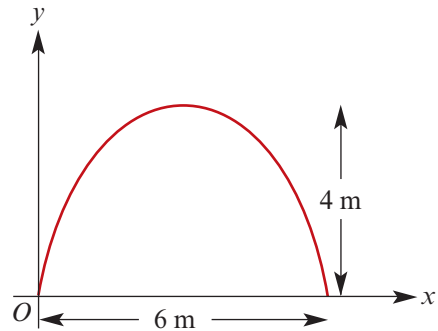

5

Vectors

Objectives

- ▶ To understand the concept of a **vector** and to apply the basic operations on vectors.
- ▶ To recognise when two vectors are **parallel**.
- ▶ To understand **linear dependence** and **linear independence**.
- ▶ To use the unit vectors i and j to represent vectors in two dimensions.
- ▶ To use the unit vectors i , j and k to represent vectors in three dimensions.
- ▶ To find the **scalar product** of two vectors.
- ▶ To use the scalar product to find the magnitude of the angle between two vectors.
- ▶ To use the scalar product to recognise when two vectors are **perpendicular**.
- ▶ To understand **vector resolutes** and **scalar resolutes**.
- ▶ To apply vector techniques to proof in geometry.

In scientific experiments, some of the things that are measured are completely determined by their magnitude. Mass, length and time are determined by a number and an appropriate unit of measurement.

length 30 cm is the length of the page of a particular book

time 10 s is the time for one athlete to run 100 m

More is required to describe velocity, displacement or force. The direction must be recorded as well as the magnitude.

displacement 30 km in a direction north

velocity 60 km/h in a direction south-east

A quantity that has both a magnitude and a direction is called a **vector**.

5A Introduction to vectors



A quantity that has a direction as well as a magnitude can be represented by an arrow:

- the arrow points in the direction of the action
- the length of the arrow gives the magnitude of the quantity in terms of a suitably chosen unit.

Arrows with the same length and direction are regarded as equivalent. These arrows are called **directed line segments** and the sets of equivalent segments are called **vectors**.

Directed line segments

The five directed line segments shown all have the same length and direction, and so they are equivalent.

A directed line segment from a point A to a point B is denoted by \overrightarrow{AB} .

For simplicity of language, this is also called vector \overrightarrow{AB} .

That is, the set of equivalent segments can be named through one member of the set.

Note: The five directed line segments in the diagram all name the same vector: $\overrightarrow{AB} = \overrightarrow{CD} = \overrightarrow{OP} = \overrightarrow{EF} = \overrightarrow{GH}$.

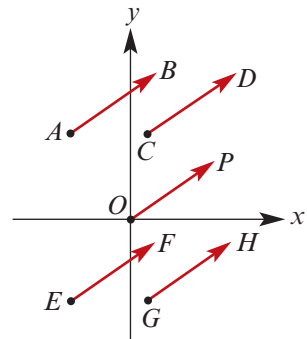

Column vectors

An alternative way to represent a vector is as a column of numbers. The column of numbers corresponds to a set of equivalent directed line segments.

For example, the column $\begin{bmatrix} 3 \\ 2 \end{bmatrix}$ corresponds to the directed line segments which go 3 across to the right and 2 up.

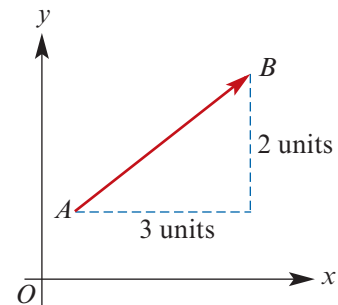

Vector notation

A vector is often denoted by a single bold lowercase letter. The vector from A to B can be denoted by \overrightarrow{AB} or by a single letter \mathbf{v} . That is, $\mathbf{v} = \overrightarrow{AB}$.

When a vector is handwritten, the notation is \mathbf{v} .

► Magnitude of vectors

The magnitude of vector \overrightarrow{AB} is denoted by $|\overrightarrow{AB}|$. Likewise, the magnitude of vector \mathbf{v} is denoted by $|\mathbf{v}|$. The magnitude of a vector is represented by the length of a directed line segment corresponding to the vector.

For \overrightarrow{AB} in the diagram above, we have $|\overrightarrow{AB}| = \sqrt{3^2 + 2^2} = \sqrt{13}$ using Pythagoras' theorem.

In general, if \overrightarrow{AB} is represented by the column vector $\begin{bmatrix} x \\ y \end{bmatrix}$, then its magnitude is given by

$$|\overrightarrow{AB}| = \sqrt{x^2 + y^2}$$

► Addition of vectors

Adding vectors geometrically

Two vectors \mathbf{u} and \mathbf{v} can be added geometrically by drawing a line segment representing \mathbf{u} from A to B and then a line segment representing \mathbf{v} from B to C .

The sum $\mathbf{u} + \mathbf{v}$ is the vector from A to C . That is,

$$\mathbf{u} + \mathbf{v} = \overrightarrow{AC}$$

The same result is achieved if the order is reversed. This is represented in the diagram on the right:

$$\begin{aligned}\mathbf{u} + \mathbf{v} &= \overrightarrow{AC} \\ &= \mathbf{v} + \mathbf{u}\end{aligned}$$

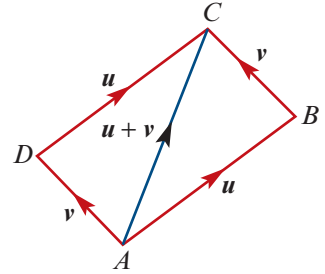
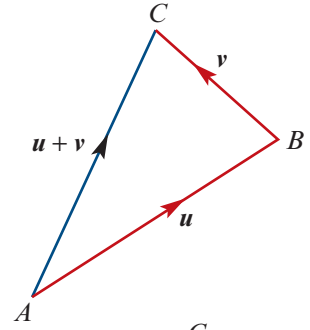

Adding column vectors

Two vectors can be added using column-vector notation.

For example, if $\mathbf{u} = \begin{bmatrix} 4 \\ 1 \end{bmatrix}$ and $\mathbf{v} = \begin{bmatrix} -1 \\ 3 \end{bmatrix}$, then

$$\mathbf{u} + \mathbf{v} = \begin{bmatrix} 4 \\ 1 \end{bmatrix} + \begin{bmatrix} -1 \\ 3 \end{bmatrix} = \begin{bmatrix} 3 \\ 4 \end{bmatrix}$$

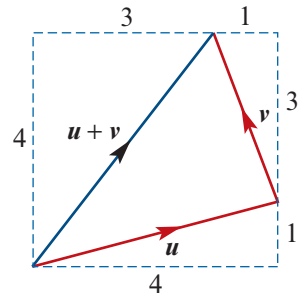

► Scalar multiplication

Multiplication by a real number (scalar) changes the length of the vector. For example:

- $2\mathbf{u}$ is twice the length of \mathbf{u}
- $\frac{1}{2}\mathbf{u}$ is half the length of \mathbf{u}

We have $2\mathbf{u} = \mathbf{u} + \mathbf{u}$ and $\frac{1}{2}\mathbf{u} + \frac{1}{2}\mathbf{u} = \mathbf{u}$.

In general, for $k \in \mathbb{R}^+$, the vector $k\mathbf{u}$ has the same direction as \mathbf{u} , but its length is multiplied by a factor of k .

When a vector is multiplied by -2 , the vector's direction is reversed and the length is doubled.

When a vector is multiplied by -1 , the vector's direction is reversed and the length remains the same.

If $\mathbf{u} = \begin{bmatrix} 3 \\ 2 \end{bmatrix}$, then $-\mathbf{u} = \begin{bmatrix} -3 \\ -2 \end{bmatrix}$, $2\mathbf{u} = \begin{bmatrix} 6 \\ 4 \end{bmatrix}$ and $-2\mathbf{u} = \begin{bmatrix} -6 \\ -4 \end{bmatrix}$.

If $\mathbf{u} = \overrightarrow{AB}$, then $-\mathbf{u} = -\overrightarrow{AB} = \overrightarrow{BA}$. The directed line segment $-\overrightarrow{AB}$ goes from B to A .

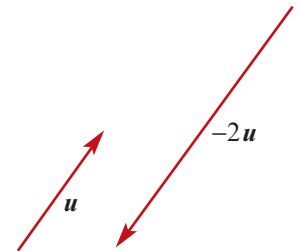
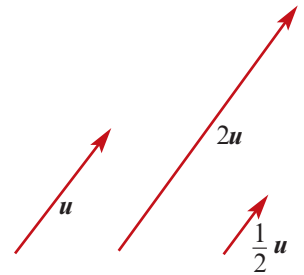

► Zero vector

The **zero vector** is denoted by $\mathbf{0}$ and represents a line segment of zero length. The zero vector has no direction. The magnitude of the zero vector is 0. Note that $0\mathbf{a} = \mathbf{0}$ and $\mathbf{a} + (-\mathbf{a}) = \mathbf{0}$.

In two dimensions, the zero vector can be written as $\mathbf{0} = \begin{bmatrix} 0 \\ 0 \end{bmatrix}$.

► Subtraction of vectors

To find $\mathbf{u} - \mathbf{v}$, we add $-\mathbf{v}$ to \mathbf{u} .

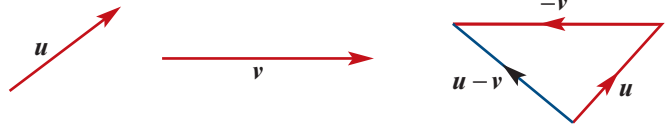

Example 1

Draw a directed line segment representing the vector $\begin{bmatrix} 3 \\ -2 \end{bmatrix}$ and state the magnitude of this vector.

Solution

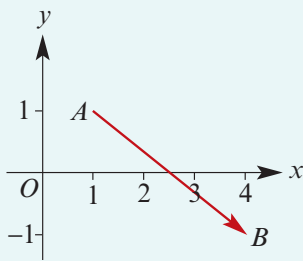

The magnitude is

$$\sqrt{3^2 + (-2)^2} = \sqrt{13}$$

Explanation

The vector $\begin{bmatrix} 3 \\ -2 \end{bmatrix}$ is '3 across to the right and 2 down'.

Note: Here the segment starts at (1, 1) and goes to (4, -1). It can start at any point.

Example 2

The vector \mathbf{u} is defined by the directed line segment from (2, 6) to (3, 1).

If $\mathbf{u} = \begin{bmatrix} a \\ b \end{bmatrix}$, find a and b .

Solution

From the diagram:

$$\begin{bmatrix} 2 \\ 6 \end{bmatrix} + \mathbf{u} = \begin{bmatrix} 3 \\ 1 \end{bmatrix}$$

$$\therefore \mathbf{u} = \begin{bmatrix} 3 - 2 \\ 1 - 6 \end{bmatrix} = \begin{bmatrix} 1 \\ -5 \end{bmatrix}$$

Hence $a = 1$ and $b = -5$.

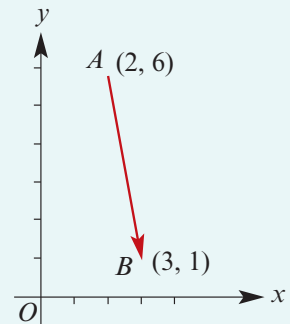

► Polygons of vectors

- For two vectors \vec{AB} and \vec{BC} , we have

$$\vec{AB} + \vec{BC} = \vec{AC}$$

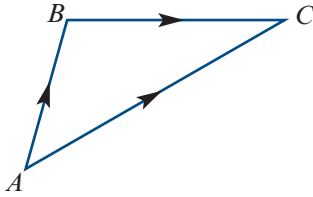

- For a polygon $ABCDEF$, we have

$$\vec{AB} + \vec{BC} + \vec{CD} + \vec{DE} + \vec{EF} + \vec{FA} = \mathbf{0}$$

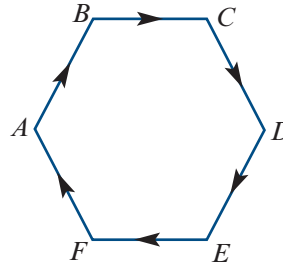

Example 3

Illustrate the vector sum $\vec{AB} + \vec{BC} + \vec{CD}$, where A, B, C and D are points in the plane.

Solution

$$\vec{AB} + \vec{BC} + \vec{CD} = \vec{AD}$$

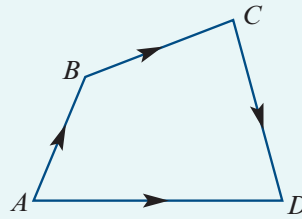

► Parallel vectors

Two parallel vectors have the same direction or opposite directions.

Two non-zero vectors \mathbf{u} and \mathbf{v} are **parallel** if there is some $k \in \mathbb{R} \setminus \{0\}$ such that $\mathbf{u} = k\mathbf{v}$.

For example, if $\mathbf{u} = \begin{bmatrix} -2 \\ 3 \end{bmatrix}$ and $\mathbf{v} = \begin{bmatrix} -6 \\ 9 \end{bmatrix}$, then the vectors \mathbf{u} and \mathbf{v} are parallel as $\mathbf{v} = 3\mathbf{u}$.

► Position vectors

We can use a point O , the origin, as a starting point for a vector to indicate the position of a point A in space relative to O .

For a point A , the **position vector** is \vec{OA} .

The two-dimensional vector

$$\mathbf{a} = \begin{bmatrix} a_1 \\ a_2 \end{bmatrix}$$

is associated with the point (a_1, a_2) . The vector \mathbf{a} can be represented by the directed line segment from the origin to the point (a_1, a_2) .

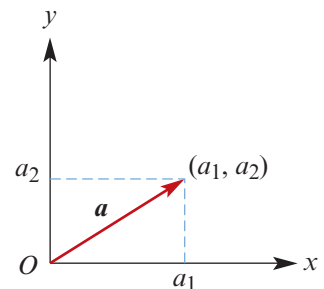

► Vectors in three dimensions

The definition of a vector is, of course, also valid in three dimensions. The properties which hold in two dimensions also hold in three dimensions.

For vectors in three dimensions, we use a third axis, denoted by z . The third axis is at right angles to the other two axes. The x -axis is drawn at an angle to indicate a direction out of the page towards you.

Vectors in three dimensions can also be written using column-vector notation:

$$\mathbf{a} = \begin{bmatrix} a_1 \\ a_2 \\ a_3 \end{bmatrix}$$

The vector \mathbf{a} can be represented by the directed line segment from the origin to the point $A(a_1, a_2, a_3)$.

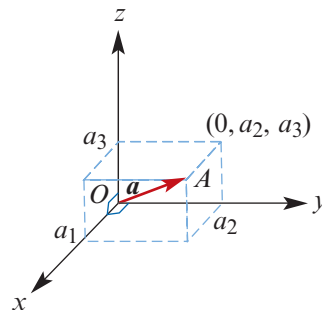

► Properties of the basic operations on vectors

The following properties are stated assuming that the vectors are all in two dimensions or all in three dimensions:

commutative law for vector addition

$$\mathbf{a} + \mathbf{b} = \mathbf{b} + \mathbf{a}$$

associative law for vector addition

$$(\mathbf{a} + \mathbf{b}) + \mathbf{c} = \mathbf{a} + (\mathbf{b} + \mathbf{c})$$

zero vector

$$\mathbf{a} + \mathbf{0} = \mathbf{a}$$

additive inverse

$$\mathbf{a} + (-\mathbf{a}) = \mathbf{0}$$

distributive law

$$m(\mathbf{a} + \mathbf{b}) = m\mathbf{a} + m\mathbf{b}, \text{ for } m \in \mathbb{R}$$

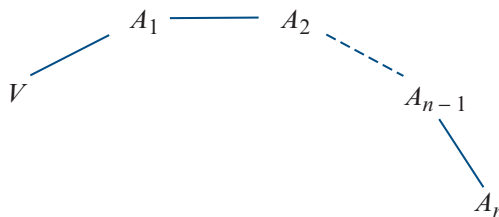

Let V, A_1, A_2, \dots, A_n be points in space.

Then $\overrightarrow{VA_1} + \overrightarrow{A_1A_2} + \overrightarrow{A_2A_3} + \dots + \overrightarrow{A_{n-1}A_n} = \overrightarrow{VA_n}$.

Example 4

$OABCDEFG$ is a cuboid as shown.

Let $\mathbf{a} = \overrightarrow{OA}$, $\mathbf{g} = \overrightarrow{OG}$ and $\mathbf{c} = \overrightarrow{OC}$.

Find the following vectors in terms of \mathbf{a} , \mathbf{g} and \mathbf{c} :

a \overrightarrow{OB} **b** \overrightarrow{OF} **c** \overrightarrow{GD} **d** \overrightarrow{GB} **e** \overrightarrow{FA}

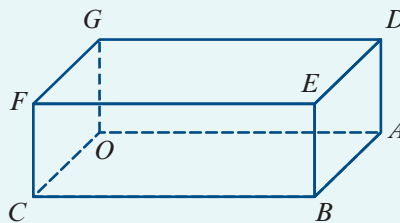

Solution

$$\begin{aligned} \mathbf{a} \quad \vec{OB} &= \vec{OA} + \vec{AB} \\ &= \mathbf{a} + \mathbf{c} \quad (\text{as } \vec{AB} = \vec{OC}) \end{aligned}$$

$$\begin{aligned} \mathbf{b} \quad \vec{OF} &= \vec{OC} + \vec{CF} \\ &= \mathbf{c} + \mathbf{g} \quad (\text{as } \vec{CF} = \vec{OG}) \end{aligned}$$

$$\begin{aligned} \mathbf{c} \quad \vec{GD} &= \vec{OA} \\ &= \mathbf{a} \end{aligned}$$

$$\begin{aligned} \mathbf{d} \quad \vec{GB} &= \vec{GD} + \vec{DA} + \vec{AB} \\ &= -\mathbf{g} + \mathbf{a} + \mathbf{c} \end{aligned}$$

$$\begin{aligned} \mathbf{e} \quad \vec{FA} &= \vec{FG} + \vec{GD} + \vec{DA} \\ &= -\mathbf{c} - \mathbf{g} + \mathbf{a} \end{aligned}$$

**Example 5**

$OABC$ is a tetrahedron,
 M is the midpoint of AC ,
 N is the midpoint of OC ,
 P is the midpoint of OB .

Let $\mathbf{a} = \vec{OA}$, $\mathbf{b} = \vec{OB}$ and $\mathbf{c} = \vec{OC}$.

Find in terms of \mathbf{a} , \mathbf{b} and \mathbf{c} :

$\mathbf{a} \quad \vec{AC} \quad \mathbf{b} \quad \vec{OM} \quad \mathbf{c} \quad \vec{CN} \quad \mathbf{d} \quad \vec{MN} \quad \mathbf{e} \quad \vec{MP}$

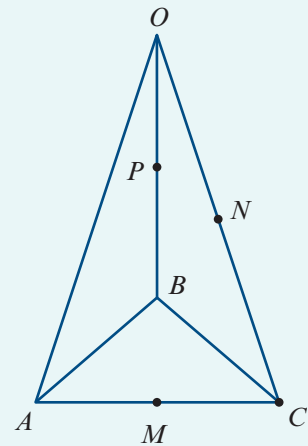
**Solution**

$$\begin{aligned} \mathbf{a} \quad \vec{AC} &= \vec{AO} + \vec{OC} \\ &= -\mathbf{a} + \mathbf{c} \end{aligned}$$

$$\begin{aligned} \mathbf{b} \quad \vec{OM} &= \vec{OA} + \vec{AM} \\ &= \vec{OA} + \frac{1}{2}\vec{AC} \\ &= \mathbf{a} + \frac{1}{2}(-\mathbf{a} + \mathbf{c}) \\ &= \frac{1}{2}(\mathbf{a} + \mathbf{c}) \end{aligned}$$

$$\begin{aligned} \mathbf{c} \quad \vec{CN} &= \frac{1}{2}\vec{CO} \\ &= \frac{1}{2}(-\mathbf{c}) \\ &= -\frac{1}{2}\mathbf{c} \end{aligned}$$

$$\begin{aligned} \mathbf{d} \quad \vec{MN} &= \vec{MO} + \vec{ON} \\ &= -\frac{1}{2}(\mathbf{a} + \mathbf{c}) + \frac{1}{2}\mathbf{c} \\ &= -\frac{1}{2}\mathbf{a} - \frac{1}{2}\mathbf{c} + \frac{1}{2}\mathbf{c} \\ &= -\frac{1}{2}\mathbf{a} \end{aligned}$$

i.e. MN is parallel to AO

$$\begin{aligned} \mathbf{e} \quad \vec{MP} &= \vec{MO} + \vec{OP} \\ &= -\frac{1}{2}(\mathbf{a} + \mathbf{c}) + \frac{1}{2}\mathbf{b} \\ &= \frac{1}{2}(\mathbf{b} - \mathbf{a} - \mathbf{c}) \end{aligned}$$

► Linear dependence and independence

A vector w is a **linear combination** of vectors v_1 , v_2 and v_3 if it can be expressed in the form

$$w = k_1v_1 + k_2v_2 + k_3v_3$$

where k_1 , k_2 and k_3 are real numbers. We have stated the definition for a linear combination of three vectors, but it could be any number of vectors.

Definition of linear dependence and linear independence

A set of vectors is said to be **linearly dependent** if at least one of its members can be expressed as a linear combination of other vectors in the set.

A set of vectors is said to be **linearly independent** if it is not linearly dependent. That is, a set of vectors is linearly independent if no vector in the set is expressible as a linear combination of other vectors in the set.

For example:

- **Two vectors** A set of two vectors a and b is linearly dependent if and only if there exist real numbers k and ℓ , not both zero, such that $ka + \ell b = \mathbf{0}$.

A set of two non-zero vectors is linearly dependent if and only if the vectors are parallel.

- **Three vectors** A set of three vectors a , b and c is linearly dependent if and only if there exist real numbers k , ℓ and m , not all zero, such that $ka + \ell b + mc = \mathbf{0}$.

Note: Any set that contains the zero vector is linearly dependent.

Any set of three or more two-dimensional vectors is linearly dependent.

Any set of four or more three-dimensional vectors is linearly dependent.

We will use the following method for checking whether three vectors are linearly dependent.

Linear dependence for three vectors

Let a and b be non-zero vectors that are not parallel. Then vectors a , b and c are linearly dependent if and only if there exist real numbers m and n such that $c = ma + nb$.

This representation of a vector c in terms of two linearly independent vectors a and b is unique, as demonstrated in the following important result.

Linear combinations of independent vectors

Let a and b be two linearly independent (i.e. not parallel) vectors. Then

$$ma + nb = pa + qb \quad \text{implies} \quad m = p \quad \text{and} \quad n = q$$

Proof Assume that $ma + nb = pa + qb$. Then $(m - p)a + (n - q)b = \mathbf{0}$. As vectors a and b are linearly independent, it follows from the definition of linear independence that $m - p = 0$ and $n - q = 0$. Hence $m = p$ and $n = q$.

Note: This result can be extended to any finite number of linearly independent vectors.

Example 6

Determine whether the following sets of vectors are linearly dependent:

a $\mathbf{a} = \begin{bmatrix} 2 \\ 1 \end{bmatrix}$, $\mathbf{b} = \begin{bmatrix} 3 \\ -1 \end{bmatrix}$ and $\mathbf{c} = \begin{bmatrix} 5 \\ 6 \end{bmatrix}$

b $\mathbf{a} = \begin{bmatrix} 3 \\ 4 \\ -1 \end{bmatrix}$, $\mathbf{b} = \begin{bmatrix} 2 \\ 1 \\ 3 \end{bmatrix}$ and $\mathbf{c} = \begin{bmatrix} -1 \\ 0 \\ 1 \end{bmatrix}$

Solution

a Note that \mathbf{a} and \mathbf{b} are not parallel.

Suppose $\mathbf{c} = m\mathbf{a} + n\mathbf{b}$

Then $5 = 2m + 3n$

$6 = m - n$

Solving the simultaneous equations, we have $m = \frac{23}{5}$ and $n = -\frac{7}{5}$.

This set of vectors is linearly dependent.

Note: In general, any set of three or more two-dimensional vectors is linearly dependent.

b Note that \mathbf{a} and \mathbf{b} are not parallel.

Suppose $\mathbf{c} = m\mathbf{a} + n\mathbf{b}$

Then $-1 = 3m + 2n$

$0 = 4m + n$

$1 = -m + 3n$

Solving the first two equations, we have $m = \frac{1}{5}$ and $n = -\frac{4}{5}$.

But these values do not satisfy the third equation, as $-m + 3n = -\frac{13}{5} \neq 1$.

The three equations have no solution, so the vectors are linearly independent.

Example 7

Points A and B have position vectors \mathbf{a} and \mathbf{b} respectively, relative to an origin O .

The point D is such that $\overrightarrow{OD} = k\overrightarrow{OA}$ and the point E is such that $\overrightarrow{AE} = \ell\overrightarrow{AB}$. The line segments BD and OE intersect at X .

Assume that $\overrightarrow{OX} = \frac{2}{5}\overrightarrow{OE}$ and $\overrightarrow{XB} = \frac{4}{5}\overrightarrow{DB}$.

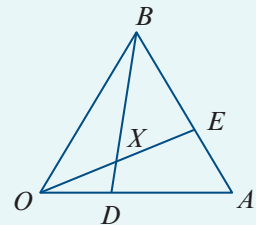

a Express \overrightarrow{XB} in terms of \mathbf{a} , \mathbf{b} and k .

b Express \overrightarrow{OX} in terms of \mathbf{a} , \mathbf{b} and ℓ .

c Express \overrightarrow{XB} in terms of \mathbf{a} , \mathbf{b} and ℓ .

d Find k and ℓ .

Solution

a $\overrightarrow{XB} = \frac{4}{5}\overrightarrow{DB}$

$= \frac{4}{5}(-\overrightarrow{OD} + \overrightarrow{OB})$

$= \frac{4}{5}(-k\overrightarrow{OA} + \overrightarrow{OB})$

$= \frac{4}{5}(-k\mathbf{a} + \mathbf{b})$

$= -\frac{4k}{5}\mathbf{a} + \frac{4}{5}\mathbf{b}$

b $\overrightarrow{OX} = \frac{2}{5}\overrightarrow{OE}$

$= \frac{2}{5}(\overrightarrow{OA} + \overrightarrow{AE})$

$= \frac{2}{5}(\overrightarrow{OA} + \ell\overrightarrow{AB})$

$= \frac{2}{5}(\mathbf{a} + \ell(\mathbf{b} - \mathbf{a}))$

$= \frac{2}{5}(1 - \ell)\mathbf{a} + \frac{2\ell}{5}\mathbf{b}$

c $\overrightarrow{XB} = \overrightarrow{XO} + \overrightarrow{OB}$

$= -\overrightarrow{OX} + \overrightarrow{OB}$

$= -\frac{2}{5}(1 - \ell)\mathbf{a} - \frac{2\ell}{5}\mathbf{b} + \mathbf{b}$

$= \frac{2}{5}(\ell - 1)\mathbf{a} + \left(1 - \frac{2\ell}{5}\right)\mathbf{b}$

- d** As \mathbf{a} and \mathbf{b} are linearly independent vectors, the vector \overrightarrow{XB} has a unique representation in terms of \mathbf{a} and \mathbf{b} . From parts **a** and **c**, we have

$$-\frac{4k}{5}\mathbf{a} + \frac{4}{5}\mathbf{b} = \frac{2}{5}(\ell - 1)\mathbf{a} + \left(1 - \frac{2\ell}{5}\right)\mathbf{b}$$

Hence

$$-\frac{4k}{5} = \frac{2}{5}(\ell - 1) \quad (1) \quad \text{and} \quad \frac{4}{5} = 1 - \frac{2\ell}{5} \quad (2)$$

From equation (2), we have

$$\frac{2\ell}{5} = \frac{1}{5}$$

$$\therefore \ell = \frac{1}{2}$$

Substitute in (1):

$$-\frac{4k}{5} = \frac{2}{5}\left(\frac{1}{2} - 1\right)$$

$$\therefore k = \frac{1}{4}$$

Exercise 5A

- Example 1** **1** Draw a directed line segment representing the vector $\begin{bmatrix} -2 \\ 1 \end{bmatrix}$ and state the magnitude of this vector.

- Example 2** **2** The vector \mathbf{u} is defined by the directed line segment from $(-2, 4)$ to $(1, 6)$.
If $\mathbf{u} = \begin{bmatrix} a \\ b \end{bmatrix}$, find a and b .

- Example 3** **3** Illustrate the vector sum $\overrightarrow{OA} + \overrightarrow{AB} + \overrightarrow{BC} + \overrightarrow{CD} + \overrightarrow{DE}$.

- 4** In the diagram, $\overrightarrow{OA} = \mathbf{a}$ and $\overrightarrow{OB} = \mathbf{b}$.

a Find in terms of \mathbf{a} and \mathbf{b} :

i \overrightarrow{OC} **ii** \overrightarrow{OE} **iii** \overrightarrow{OD}

iv \overrightarrow{DC} **v** \overrightarrow{DE}

b If $|\mathbf{a}| = 1$ and $|\mathbf{b}| = 2$, find:

i $|\overrightarrow{OC}|$ **ii** $|\overrightarrow{OE}|$ **iii** $|\overrightarrow{OD}|$

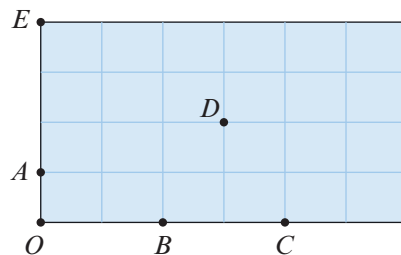

- 5** Using a scale of 1 cm = 20 km/h, draw vectors to represent:

a a car travelling south at 60 km/h

b a car travelling north at 80 km/h

- 6** If the vector \mathbf{a} has magnitude 3, find the magnitude of:

a $2\mathbf{a}$ **b** $\frac{3}{2}\mathbf{a}$ **c** $-\frac{1}{2}\mathbf{a}$

7 $OA' = A'A'' = A''A''' = A'''A$

$OB' = B'B'' = B''B''' = B'''B$

If $\mathbf{a} = \overrightarrow{OA}$ and $\mathbf{b} = \overrightarrow{OB}$, find in terms of \mathbf{a} and \mathbf{b} :

a i $\overrightarrow{OA'}$ ii $\overrightarrow{OB'}$ iii $\overrightarrow{A'B'}$ iv \overrightarrow{AB}

b i $\overrightarrow{OA''}$ ii $\overrightarrow{OB''}$ iii $\overrightarrow{A''B''}$

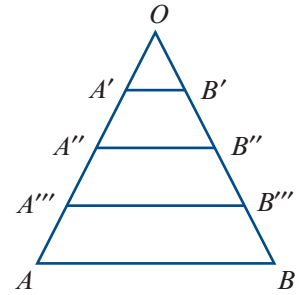

8 Find in terms of \mathbf{a} , \mathbf{b} , \mathbf{c} and \mathbf{d} :

a \overrightarrow{XW} **b** \overrightarrow{VX} **c** \overrightarrow{ZY}

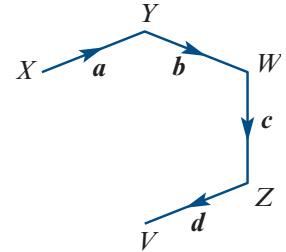

9 The position vectors of two points A and B are \mathbf{a} and \mathbf{b} .
The point M is the midpoint of AB . Find:

a \overrightarrow{AB} **b** \overrightarrow{AM} **c** \overrightarrow{OM}

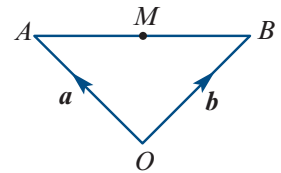

10 $ABCD$ is a trapezium with AB parallel to DC .
 X and Y are the midpoints of AD and BC respectively.

a Express \overrightarrow{XY} in terms of \mathbf{a} and \mathbf{b} , where
 $\mathbf{a} = \overrightarrow{AB}$ and $\mathbf{b} = \overrightarrow{DC}$.

b Show that XY is parallel to AB .

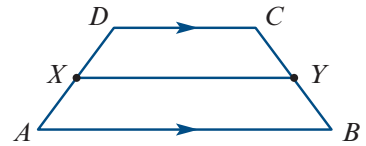

11 $ABCDEF$ is a regular hexagon with centre G .
The position vectors of A , B and C , relative to an origin O , are \mathbf{a} , \mathbf{b} and \mathbf{c} respectively.

a Express \overrightarrow{OG} in terms of \mathbf{a} , \mathbf{b} and \mathbf{c} .

b Express \overrightarrow{CD} in terms of \mathbf{a} , \mathbf{b} and \mathbf{c} .

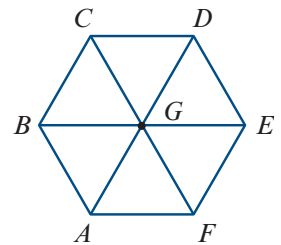

Example 4 12 For the cuboid shown, let $\mathbf{a} = \overrightarrow{OA}$, $\mathbf{c} = \overrightarrow{OC}$ and $\mathbf{g} = \overrightarrow{OG}$.
Let M be the midpoint of ED .

Find each of the following in terms of \mathbf{a} , \mathbf{c} and \mathbf{g} :

a \overrightarrow{EF} **b** \overrightarrow{AB} **c** \overrightarrow{EM} **d** \overrightarrow{OM} **e** \overrightarrow{AM}

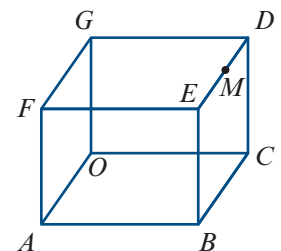

Example 5 **13** $OABCD$ is a right square pyramid. Let $\mathbf{a} = \overrightarrow{OA}$, $\mathbf{b} = \overrightarrow{OB}$, $\mathbf{c} = \overrightarrow{OC}$ and $\mathbf{d} = \overrightarrow{OD}$.

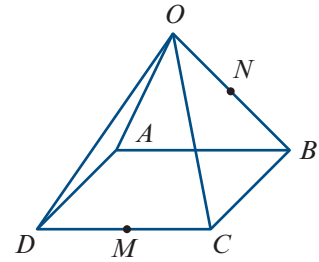

- a**
- Find \overrightarrow{AB} in terms of \mathbf{a} and \mathbf{b} .
 - Find \overrightarrow{DC} in terms of \mathbf{c} and \mathbf{d} .
 - Use the fact that $\overrightarrow{AB} = \overrightarrow{DC}$ to find a relationship between \mathbf{a} , \mathbf{b} , \mathbf{c} and \mathbf{d} .
- b**
- Find \overrightarrow{BC} in terms of \mathbf{b} and \mathbf{c} .
 - Let M be the midpoint of DC and N the midpoint of OB . Find \overrightarrow{MN} in terms of \mathbf{a} , \mathbf{b} and \mathbf{c} .

Example 6 **14** Determine whether the following sets of vectors are linearly dependent:

- a** $\mathbf{a} = \begin{bmatrix} 4 \\ 1 \\ 3 \end{bmatrix}$, $\mathbf{b} = \begin{bmatrix} 2 \\ -1 \\ 3 \end{bmatrix}$ and $\mathbf{c} = \begin{bmatrix} -4 \\ 2 \\ 6 \end{bmatrix}$
- b** $\mathbf{a} = \begin{bmatrix} 3 \\ 1 \\ 2 \end{bmatrix}$, $\mathbf{b} = \begin{bmatrix} 4 \\ 2 \\ 1 \end{bmatrix}$ and $\mathbf{c} = \begin{bmatrix} 6 \\ 3 \\ 4 \end{bmatrix}$
- c** $\mathbf{a} = \begin{bmatrix} 1 \\ 1 \\ -1 \end{bmatrix}$, $\mathbf{b} = \begin{bmatrix} 3 \\ -1 \\ 4 \end{bmatrix}$ and $\mathbf{c} = \begin{bmatrix} 3 \\ -5 \\ 11 \end{bmatrix}$

15 Let \mathbf{a} and \mathbf{b} be non-zero vectors that are not parallel.

- a** If $k\mathbf{a} + \ell\mathbf{b} = 3\mathbf{a} + (1 - \ell)\mathbf{b}$, find the values of k and ℓ .
- b** If $2(\ell - 1)\mathbf{a} + \left(1 - \frac{\ell}{5}\right)\mathbf{b} = -\frac{4k}{5}\mathbf{a} + 3\mathbf{b}$, find the values of k and ℓ .

Example 7 **16** Points P , Q and R have position vectors $2\mathbf{a} - \mathbf{b}$, $3\mathbf{a} + \mathbf{b}$ and $\mathbf{a} + 4\mathbf{b}$ respectively, relative to an origin O , where \mathbf{a} and \mathbf{b} are non-zero, non-parallel vectors. The point S is on the line OP with $\overrightarrow{OS} = k\overrightarrow{OP}$ and $\overrightarrow{RS} = m\overrightarrow{RQ}$.

- a** Express \overrightarrow{OS} in terms of:
- k , \mathbf{a} and \mathbf{b}
 - m , \mathbf{a} and \mathbf{b}
- b** Hence evaluate k and m .

17 The position vectors of points A and B , relative to an origin O , are \mathbf{a} and \mathbf{b} respectively, where \mathbf{a} and \mathbf{b} are non-zero, non-parallel vectors. The point P is such that $\overrightarrow{OP} = 4\overrightarrow{OB}$. The midpoint of AB is the point Q . The point R is such that $\overrightarrow{OR} = \frac{8}{5}\overrightarrow{OQ}$.

- a** Find in terms of \mathbf{a} and \mathbf{b} :
- \overrightarrow{OQ}
 - \overrightarrow{OR}
 - \overrightarrow{AR}
 - \overrightarrow{RP}
- b** Show that R lies on AP and state the ratio $AR : RP$.
- c** Given that the point S is such that $\overrightarrow{OS} = \lambda\overrightarrow{OQ}$, find the value of λ such that PS is parallel to BA .

18 Let $\mathbf{a} = \begin{bmatrix} 2 \\ 1 \end{bmatrix}$ and $\mathbf{b} = \begin{bmatrix} 1 \\ -3 \end{bmatrix}$. Find the values of x and y for which:

- a** $x\mathbf{a} = (y - 1)\mathbf{b}$
- b** $(2 - x)\mathbf{a} = 3\mathbf{a} + (7 - 3y)\mathbf{b}$
- c** $(5 + 2x)(\mathbf{a} + \mathbf{b}) = y(3\mathbf{a} + 2\mathbf{b})$



5B Resolution of a vector into rectangular components

A **unit vector** is a vector of magnitude 1. For a non-zero vector \mathbf{a} , the unit vector with the same direction as \mathbf{a} is denoted by $\hat{\mathbf{a}}$ and given by

$$\hat{\mathbf{a}} = \frac{1}{|\mathbf{a}|} \mathbf{a}$$

- The unit vector in the positive direction of the x -axis is \mathbf{i} .
- The unit vector in the positive direction of the y -axis is \mathbf{j} .
- The unit vector in the positive direction of the z -axis is \mathbf{k} .

In two dimensions: $\mathbf{i} = \begin{bmatrix} 1 \\ 0 \end{bmatrix}$ and $\mathbf{j} = \begin{bmatrix} 0 \\ 1 \end{bmatrix}$.

In three dimensions: $\mathbf{i} = \begin{bmatrix} 1 \\ 0 \\ 0 \end{bmatrix}$, $\mathbf{j} = \begin{bmatrix} 0 \\ 1 \\ 0 \end{bmatrix}$ and $\mathbf{k} = \begin{bmatrix} 0 \\ 0 \\ 1 \end{bmatrix}$.

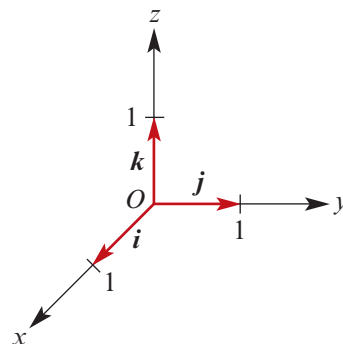

The vectors \mathbf{i} , \mathbf{j} and \mathbf{k} are linearly independent. Every vector in two or three dimensions can be expressed uniquely as a linear combination of \mathbf{i} , \mathbf{j} and \mathbf{k} :

e.g. $\mathbf{r} = \begin{bmatrix} r_1 \\ r_2 \\ r_3 \end{bmatrix} = \begin{bmatrix} r_1 \\ 0 \\ 0 \end{bmatrix} + \begin{bmatrix} 0 \\ r_2 \\ 0 \end{bmatrix} + \begin{bmatrix} 0 \\ 0 \\ r_3 \end{bmatrix} = r_1\mathbf{i} + r_2\mathbf{j} + r_3\mathbf{k}$

Two dimensions

For the point $P(x, y)$:

$$\overrightarrow{OP} = x\mathbf{i} + y\mathbf{j}$$

$$|\overrightarrow{OP}| = \sqrt{x^2 + y^2}$$

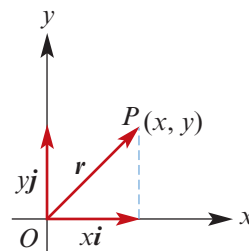

Three dimensions

For the point $P(x, y, z)$:

$$\overrightarrow{OP} = x\mathbf{i} + y\mathbf{j} + z\mathbf{k}$$

$$|\overrightarrow{OP}| = \sqrt{x^2 + y^2 + z^2}$$

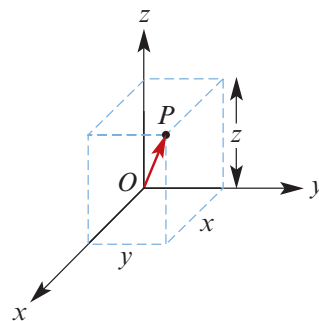

Basic operations in component form

Let $\mathbf{a} = a_1\mathbf{i} + a_2\mathbf{j} + a_3\mathbf{k}$ and $\mathbf{b} = b_1\mathbf{i} + b_2\mathbf{j} + b_3\mathbf{k}$.

Then $\mathbf{a} + \mathbf{b} = (a_1 + b_1)\mathbf{i} + (a_2 + b_2)\mathbf{j} + (a_3 + b_3)\mathbf{k}$

$$\mathbf{a} - \mathbf{b} = (a_1 - b_1)\mathbf{i} + (a_2 - b_2)\mathbf{j} + (a_3 - b_3)\mathbf{k}$$

and $m\mathbf{a} = ma_1\mathbf{i} + ma_2\mathbf{j} + ma_3\mathbf{k}$ for a scalar m

Equivalence

If $\mathbf{a} = \mathbf{b}$, then $a_1 = b_1$, $a_2 = b_2$ and $a_3 = b_3$.

Magnitude

$$|\mathbf{a}| = \sqrt{a_1^2 + a_2^2 + a_3^2}$$

Example 8

- a** Using the vectors i and j , give the vectors:
i \vec{OA} **ii** \vec{OB} **iii** \vec{OC} **iv** \vec{OD}
- b** Using the vectors i and j , give the vectors:
i \vec{AB} **ii** \vec{BC}
- c** Find the magnitudes of the vectors:
i \vec{AB} **ii** \vec{BC}

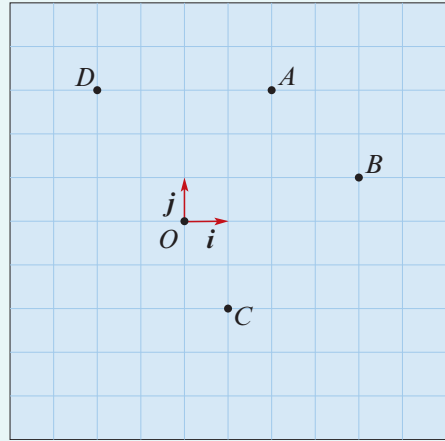
**Solution**

- a** **i** $\vec{OA} = 2i + 3j$ **ii** $\vec{OB} = 4i + j$ **iii** $\vec{OC} = i - 2j$ **iv** $\vec{OD} = -2i + 3j$
- b** **i** $\vec{AB} = \vec{AO} + \vec{OB}$
 $= -2i - 3j + 4i + j$
 $= 2i - 2j$
- ii** $\vec{BC} = \vec{BO} + \vec{OC}$
 $= -4i - j + i - 2j$
 $= -3i - 3j$
- c** **i** $|\vec{AB}| = \sqrt{2^2 + (-2)^2}$
 $= \sqrt{8}$
 $= 2\sqrt{2}$
- ii** $|\vec{BC}| = \sqrt{(-3)^2 + (-3)^2}$
 $= \sqrt{18}$
 $= 3\sqrt{2}$

Example 9

Let $a = i + 2j - k$, $b = 3i - 2k$ and $c = 2i + j + k$. Find:

- a** $a + b$ **b** $a - 2b$ **c** $a + b + c$ **d** $|a|$

Solution

- a** $a + b = (i + 2j - k) + (3i - 2k)$
 $= 4i + 2j - 3k$
- b** $a - 2b = (i + 2j - k) - 2(3i - 2k)$
 $= -5i + 2j + 3k$
- c** $a + b + c = (i + 2j - k) + (3i - 2k) + (2i + j + k)$
 $= 6i + 3j - 2k$
- d** $|a| = \sqrt{1^2 + 2^2 + (-1)^2} = \sqrt{6}$

Example 10

A cuboid is labelled as shown.

$$\vec{OA} = 3\mathbf{i}, \quad \vec{OB} = 5\mathbf{j}, \quad \vec{OC} = 4\mathbf{k}$$

a Find in terms of \mathbf{i} , \mathbf{j} and \mathbf{k} :

i \vec{DB} **ii** \vec{OD} **iii** \vec{DF} **iv** \vec{OF}

b Find $|\vec{OF}|$.

c If M is the midpoint of FG , find:

i \vec{OM} **ii** $|\vec{OM}|$

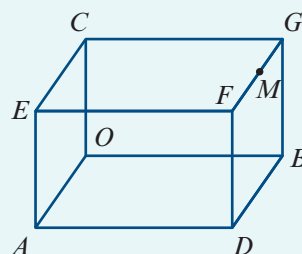
**Solution**

a i $\vec{DB} = \vec{AO}$
 $= -\vec{OA}$
 $= -3\mathbf{i}$

ii $\vec{OD} = \vec{OB} + \vec{BD}$
 $= 5\mathbf{j} + \vec{OA}$
 $= 5\mathbf{j} + 3\mathbf{i}$
 $= 3\mathbf{i} + 5\mathbf{j}$

iii $\vec{DF} = \vec{OC}$
 $= 4\mathbf{k}$

iv $\vec{OF} = \vec{OD} + \vec{DF}$
 $= 3\mathbf{i} + 5\mathbf{j} + 4\mathbf{k}$

b $|\vec{OF}| = \sqrt{9 + 25 + 16}$
 $= \sqrt{50}$
 $= 5\sqrt{2}$

c i $\vec{OM} = \vec{OD} + \vec{DF} + \vec{FM}$
 $= 3\mathbf{i} + 5\mathbf{j} + 4\mathbf{k} + \frac{1}{2}(-\vec{GF})$
 $= 3\mathbf{i} + 5\mathbf{j} + 4\mathbf{k} + \frac{1}{2}(-3\mathbf{i})$
 $= \frac{3}{2}\mathbf{i} + 5\mathbf{j} + 4\mathbf{k}$

ii $|\vec{OM}| = \sqrt{\frac{9}{4} + 25 + 16}$
 $= \frac{1}{2}\sqrt{9 + 100 + 64}$
 $= \frac{1}{2}\sqrt{173}$

Example 11

If $\mathbf{a} = x\mathbf{i} + 3\mathbf{j}$ and $\mathbf{b} = 8\mathbf{i} + 2y\mathbf{j}$ such that $\mathbf{a} + \mathbf{b} = -2\mathbf{i} + 4\mathbf{j}$, find the values of x and y .

Solution

$$\mathbf{a} + \mathbf{b} = (x + 8)\mathbf{i} + (2y + 3)\mathbf{j} = -2\mathbf{i} + 4\mathbf{j}$$

$$\therefore x + 8 = -2 \quad \text{and} \quad 2y + 3 = 4$$

$$\text{i.e.} \quad x = -10 \quad \text{and} \quad y = \frac{1}{2}$$



Example 12

Let $A = (2, -3)$, $B = (1, 4)$ and $C = (-1, -3)$. The origin is O . Find:

- a** i \overrightarrow{OA} ii \overrightarrow{AB} iii \overrightarrow{BC}
b F such that $\overrightarrow{OF} = \frac{1}{2}\overrightarrow{OA}$
c G such that $\overrightarrow{AG} = 3\overrightarrow{BC}$

Solution

$$\begin{array}{lll} \mathbf{a} \text{ i } \overrightarrow{OA} = 2\mathbf{i} - 3\mathbf{j} & \text{ii } \overrightarrow{AB} = \overrightarrow{AO} + \overrightarrow{OB} & \text{iii } \overrightarrow{BC} = \overrightarrow{BO} + \overrightarrow{OC} \\ & = -2\mathbf{i} + 3\mathbf{j} + \mathbf{i} + 4\mathbf{j} & = -\mathbf{i} - 4\mathbf{j} - \mathbf{i} - 3\mathbf{j} \\ & = -\mathbf{i} + 7\mathbf{j} & = -2\mathbf{i} - 7\mathbf{j} \end{array}$$

$$\mathbf{b} \quad \overrightarrow{OF} = \frac{1}{2}\overrightarrow{OA} = \frac{1}{2}(2\mathbf{i} - 3\mathbf{j}) = \mathbf{i} - \frac{3}{2}\mathbf{j}$$

Hence $F = (1, -1.5)$

$$\mathbf{c} \quad \overrightarrow{AG} = 3\overrightarrow{BC} = 3(-2\mathbf{i} - 7\mathbf{j}) = -6\mathbf{i} - 21\mathbf{j}$$

Therefore

$$\begin{aligned} \overrightarrow{OG} &= \overrightarrow{OA} + \overrightarrow{AG} \\ &= 2\mathbf{i} - 3\mathbf{j} - 6\mathbf{i} - 21\mathbf{j} \\ &= -4\mathbf{i} - 24\mathbf{j} \end{aligned}$$

Hence $G = (-4, -24)$

Example 13

Let $A = (2, -4, 5)$ and $B = (5, 1, 7)$. Find M , the midpoint of AB .

Solution

We have $\overrightarrow{OA} = 2\mathbf{i} - 4\mathbf{j} + 5\mathbf{k}$ and $\overrightarrow{OB} = 5\mathbf{i} + \mathbf{j} + 7\mathbf{k}$.

$$\begin{aligned} \text{Thus } \overrightarrow{AB} &= \overrightarrow{AO} + \overrightarrow{OB} \\ &= -2\mathbf{i} + 4\mathbf{j} - 5\mathbf{k} + 5\mathbf{i} + \mathbf{j} + 7\mathbf{k} \\ &= 3\mathbf{i} + 5\mathbf{j} + 2\mathbf{k} \end{aligned}$$

$$\text{and so } \overrightarrow{AM} = \frac{1}{2}(3\mathbf{i} + 5\mathbf{j} + 2\mathbf{k})$$

$$\begin{aligned} \text{Now } \overrightarrow{OM} &= \overrightarrow{OA} + \overrightarrow{AM} \\ &= 2\mathbf{i} - 4\mathbf{j} + 5\mathbf{k} + \frac{3}{2}\mathbf{i} + \frac{5}{2}\mathbf{j} + \mathbf{k} \\ &= \frac{7}{2}\mathbf{i} - \frac{3}{2}\mathbf{j} + 6\mathbf{k} \end{aligned}$$

$$\text{Hence } M = \left(\frac{7}{2}, \frac{-3}{2}, 6\right)$$



Example 14

- a** Show that the vectors $\mathbf{a} = 8\mathbf{i} + 7\mathbf{j} + 3\mathbf{k}$, $\mathbf{b} = \mathbf{i} - \mathbf{j} + 3\mathbf{k}$ and $\mathbf{c} = 2\mathbf{i} + 3\mathbf{j} - \mathbf{k}$ are linearly dependent.
- b** Show that the vectors $\mathbf{a} = 8\mathbf{i} + 7\mathbf{j} + 3\mathbf{k}$, $\mathbf{b} = \mathbf{i} - \mathbf{j} + 3\mathbf{k}$ and $\mathbf{c} = 2\mathbf{i} + 3\mathbf{j} + \mathbf{k}$ are linearly independent.

Solution

- a** Vectors \mathbf{b} and \mathbf{c} are not parallel. We want to find constants m and n such that $\mathbf{a} = m\mathbf{b} + n\mathbf{c}$. Consider

$$8\mathbf{i} + 7\mathbf{j} + 3\mathbf{k} = m(\mathbf{i} - \mathbf{j} + 3\mathbf{k}) + n(2\mathbf{i} + 3\mathbf{j} - \mathbf{k})$$

This implies

$$8 = m + 2n \quad (1) \quad 7 = -m + 3n \quad (2) \quad 3 = 3m - n \quad (3)$$

Adding (1) and (2) gives $15 = 5n$, which implies $n = 3$.

Substitute in (1) to obtain $m = 2$.

The solution $m = 2$ and $n = 3$ must be verified for (3): $3m - n = 3 \times 2 - 3 = 3$.

Therefore

$$\mathbf{a} = 2\mathbf{b} + 3\mathbf{c} \quad \text{or equivalently} \quad \mathbf{a} - 2\mathbf{b} - 3\mathbf{c} = \mathbf{0}$$

Vectors \mathbf{a} , \mathbf{b} and \mathbf{c} are linearly dependent.

- b** Equations (1) and (2) are unchanged, and equation (3) becomes

$$3 = 3m + n \quad (3)$$

But substituting $m = 2$ and $n = 3$ gives $3m + n = 9 \neq 3$.

The three equations have no solution, so the vectors are linearly independent.

► Angle made by a vector with an axis

The *direction* of a vector can be given by the angles which the vector makes with the \mathbf{i} , \mathbf{j} and \mathbf{k} directions.

If the vector $\mathbf{a} = a_1\mathbf{i} + a_2\mathbf{j} + a_3\mathbf{k}$ makes angles α , β and γ with the positive directions of the x -, y - and z -axes respectively, then

$$\cos \alpha = \frac{a_1}{|\mathbf{a}|}, \quad \cos \beta = \frac{a_2}{|\mathbf{a}|}, \quad \cos \gamma = \frac{a_3}{|\mathbf{a}|}$$

The derivation of these results is left as an exercise.

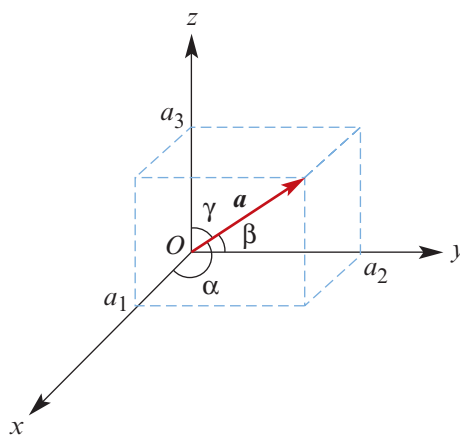

Example 15

Let $\mathbf{a} = 2\mathbf{i} - \mathbf{j}$ and $\mathbf{b} = \mathbf{i} + 4\mathbf{j} - 3\mathbf{k}$.

For each of these vectors, find:

- a** its magnitude
- b** the angle the vector makes with the y -axis.

Solution

a $|\mathbf{a}| = \sqrt{2^2 + (-1)^2} = \sqrt{5}$

$|\mathbf{b}| = \sqrt{1^2 + 4^2 + (-3)^2} = \sqrt{26}$

- b** The angle that \mathbf{a} makes with the y -axis is

$$\cos^{-1}\left(\frac{-1}{\sqrt{5}}\right) \approx 116.57^\circ$$

The angle that \mathbf{b} makes with the y -axis is

$$\cos^{-1}\left(\frac{4}{\sqrt{26}}\right) \approx 38.33^\circ$$

Example 16

A position vector in two dimensions has magnitude 5 and its direction, measured anticlockwise from the x -axis, is 150° . Express this vector in terms of \mathbf{i} and \mathbf{j} .

Solution

Let $\mathbf{a} = a_1\mathbf{i} + a_2\mathbf{j}$.

The vector \mathbf{a} makes an angle of 150° with the x -axis and an angle of 60° with the y -axis.

Therefore

$$\cos 150^\circ = \frac{a_1}{|\mathbf{a}|} \quad \text{and} \quad \cos 60^\circ = \frac{a_2}{|\mathbf{a}|}$$

Since $|\mathbf{a}| = 5$, this gives

$$a_1 = |\mathbf{a}| \cos 150^\circ = \frac{-5\sqrt{3}}{2}$$

$$a_2 = |\mathbf{a}| \cos 60^\circ = \frac{5}{2}$$

$$\therefore \mathbf{a} = \frac{-5\sqrt{3}}{2}\mathbf{i} + \frac{5}{2}\mathbf{j}$$

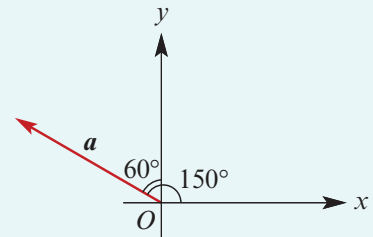



Example 17

Let \mathbf{i} be a unit vector in the east direction and let \mathbf{j} be a unit vector in the north direction, with units in kilometres.

- a** Show that the unit vector in the direction N60°W is $-\frac{\sqrt{3}}{2}\mathbf{i} + \frac{1}{2}\mathbf{j}$.
- b** If a car drives 3 km in the direction N60°W, find the position vector of the car with respect to its starting point.
- c** The car then drives 6.5 km due north. Find:
- the position vector of the car
 - the distance of the car from the starting point
 - the bearing of the car from the starting point.

Solution

- a** Let \mathbf{r} denote the unit vector in the direction N60°W.

$$\begin{aligned}\text{Then } \mathbf{r} &= -\cos 30^\circ \mathbf{i} + \cos 60^\circ \mathbf{j} \\ &= -\frac{\sqrt{3}}{2} \mathbf{i} + \frac{1}{2} \mathbf{j}\end{aligned}$$

Note: $|\mathbf{r}| = 1$

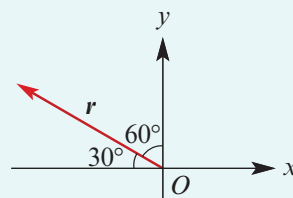

- b** The position vector is

$$3\mathbf{r} = 3\left(-\frac{\sqrt{3}}{2}\mathbf{i} + \frac{1}{2}\mathbf{j}\right) = -\frac{3\sqrt{3}}{2}\mathbf{i} + \frac{3}{2}\mathbf{j}$$

- c** Let \mathbf{r}' denote the new position vector.

$$\begin{aligned}\text{i } \mathbf{r}' &= 3\mathbf{r} + 6.5\mathbf{j} \\ &= -\frac{3\sqrt{3}}{2}\mathbf{i} + \frac{3}{2}\mathbf{j} + \frac{13}{2}\mathbf{j} \\ &= -\frac{3\sqrt{3}}{2}\mathbf{i} + 8\mathbf{j}\end{aligned}$$

$$\begin{aligned}\text{ii } |\mathbf{r}'| &= \sqrt{\frac{9 \times 3}{4} + 64} \\ &= \sqrt{\frac{27 + 256}{4}} \\ &= \frac{1}{2}\sqrt{283}\end{aligned}$$

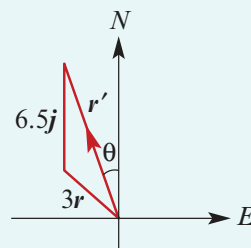

- iii** Since $\mathbf{r}' = -\frac{3\sqrt{3}}{2}\mathbf{i} + 8\mathbf{j}$, we have

$$\tan \theta^\circ = \frac{3\sqrt{3}}{16}$$

$$\therefore \theta^\circ = \tan^{-1}\left(\frac{3\sqrt{3}}{16}\right) \approx 18^\circ$$

The bearing is 342°, correct to the nearest degree.

Exercise 5B

Skillsheet

- 1 a** Give each of the following vectors in terms of i and j :
i \vec{OA} **ii** \vec{OB} **iii** \vec{OC} **iv** \vec{OD}
- b** Find each of the following:
i \vec{AB} **ii** \vec{CD} **iii** \vec{DA}
- c** Find the magnitude of each of the following:
i \vec{OA} **ii** \vec{AB} **iii** \vec{DA}

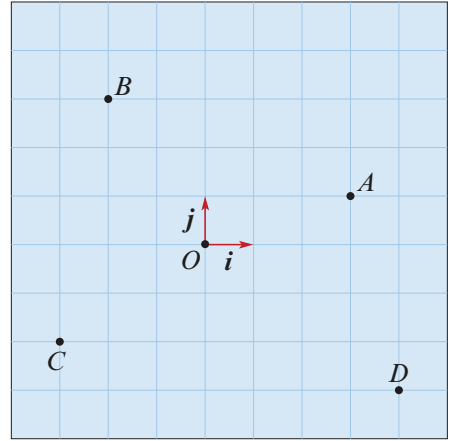

Example 9 **2** Let $a = 2i + 2j - k$, $b = -i + 2j + k$ and $c = 4k$. Find:

- a** $a + b$ **b** $2a + c$ **c** $a + 2b - c$ **d** $c - 4a$ **e** $|b|$ **f** $|c|$

Example 10

- 3** $OABCDEFG$ is a cuboid set on Cartesian axes with $\vec{OA} = 5i$, $\vec{OC} = 2j$ and $\vec{OG} = 3k$.

a Find:

- i** \vec{BC} **ii** \vec{CF} **iii** \vec{AB}
iv \vec{OD} **v** \vec{OE} **vi** \vec{GE}
vii \vec{EC} **viii** \vec{DB} **ix** \vec{DC}
x \vec{BG} **xi** \vec{GB} **xii** \vec{FA}

b Evaluate:

- i** $|\vec{OD}|$ **ii** $|\vec{OE}|$ **iii** $|\vec{GE}|$

c Let M be the midpoint of CB . Find:

- i** \vec{CM} **ii** \vec{OM} **iii** \vec{DM}

d Let N be the point on FG such that $\vec{FN} = 2\vec{NG}$. Find:

- i** \vec{FN} **ii** \vec{GN} **iii** \vec{ON} **iv** \vec{NA} **v** \vec{NM}

e Evaluate:

- i** $|\vec{NM}|$ **ii** $|\vec{DM}|$ **iii** $|\vec{AN}|$

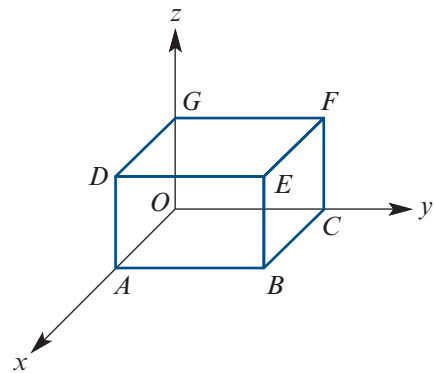

Example 11

- 4** Find the values of x and y if:

- a** $a = 4i - j$, $b = xi + 3yj$, $a + b = 7i - 2j$
b $a = xi + 3j$, $b = -2i + 5yj$, $a - b = 6i + j$
c $a = 6i + yj$, $b = xi - 4j$, $a + 2b = 3i - j$

Example 12 5 Let $A = (-2, 4)$, $B = (1, 6)$ and $C = (-1, -6)$. Let O be the origin. Find:

a i \vec{OA} ii \vec{AB} iii \vec{BC}

b F such that $\vec{OF} = \frac{1}{2}\vec{OA}$

c G such that $\vec{AG} = 3\vec{BC}$

Example 13 6 Let $A = (1, -6, 7)$ and $B = (5, -1, 9)$. Find M , the midpoint of AB .

7 Points A, B, C and D have position vectors $\mathbf{a} = \mathbf{i} + 3\mathbf{j} - 2\mathbf{k}$, $\mathbf{b} = 5\mathbf{i} + \mathbf{j} - 6\mathbf{k}$, $\mathbf{c} = 5\mathbf{j} + 3\mathbf{k}$ and $\mathbf{d} = 2\mathbf{i} + 4\mathbf{j} + \mathbf{k}$ respectively.

a Find:

i \vec{AB} ii \vec{BC} iii \vec{CD} iv \vec{DA}

b Evaluate:

i $|\vec{AC}|$ ii $|\vec{BD}|$

c Find the two parallel vectors in **a**.

8 Points A and B are defined by the position vectors $\mathbf{a} = \mathbf{i} + \mathbf{j} - 5\mathbf{k}$ and $\mathbf{b} = 3\mathbf{i} - 2\mathbf{j} - \mathbf{k}$ respectively. The point M is on the line segment AB such that $AM : MB = 4 : 1$.

a Find:

i \vec{AB} ii \vec{AM} iii \vec{OM}

b Find the coordinates of M .

Example 14 9 **a** Show that the vectors $\mathbf{a} = 8\mathbf{i} + 5\mathbf{j} + 2\mathbf{k}$, $\mathbf{b} = 4\mathbf{i} - 3\mathbf{j} + \mathbf{k}$ and $\mathbf{c} = 2\mathbf{i} - \mathbf{j} + \frac{1}{2}\mathbf{k}$ are linearly dependent.

b Show that the vectors $\mathbf{a} = 8\mathbf{i} + 5\mathbf{j} + 2\mathbf{k}$, $\mathbf{b} = 4\mathbf{i} - 3\mathbf{j} + \mathbf{k}$ and $\mathbf{c} = 2\mathbf{i} - \mathbf{j} + 2\mathbf{k}$ are linearly independent.

10 The vectors $\mathbf{a} = 2\mathbf{i} - 3\mathbf{j} + \mathbf{k}$, $\mathbf{b} = 4\mathbf{i} + 3\mathbf{j} - 2\mathbf{k}$ and $\mathbf{c} = 2\mathbf{i} - 4\mathbf{j} + x\mathbf{k}$ are linearly dependent. Find the value of x .

11 $A = (2, 1)$, $B = (1, -3)$, $C = (-5, 2)$, $D = (3, 5)$ and O is the origin.

a Find:

i \vec{OA} ii \vec{AB} iii \vec{BC} iv \vec{BD}

b Show that \vec{AB} and \vec{BD} are parallel.

c What can be said about the points A, B and D ?

12 Let $A = (1, 4, -4)$, $B = (2, 3, 1)$, $C = (0, -1, 4)$ and $D = (4, 5, 6)$.

a Find:

i \vec{OB} ii \vec{AC} iii \vec{BD} iv \vec{CD}

b Show that \vec{OB} and \vec{CD} are parallel.

- 13** Let $A = (1, 4, -2)$, $B = (3, 3, 0)$, $C = (2, 5, 3)$ and $D = (0, 6, 1)$.
- a** Find:
- i** \overrightarrow{AB} **ii** \overrightarrow{BC} **iii** \overrightarrow{CD} **iv** \overrightarrow{DA}
- b** Describe the quadrilateral $ABCD$.
- 14** Let $A = (5, 1)$, $B = (0, 4)$ and $C = (-1, 0)$. Find:
- a** D such that $\overrightarrow{AB} = \overrightarrow{CD}$
- b** E such that $\overrightarrow{AE} = -\overrightarrow{BC}$
- c** G such that $\overrightarrow{AB} = 2\overrightarrow{GC}$
- 15** $ABCD$ is a parallelogram, where $A = (2, 1)$, $B = (-5, 4)$, $C = (1, 7)$ and $D = (x, y)$.
- a** Find:
- i** \overrightarrow{BC} **ii** \overrightarrow{AD} (in terms of x and y)
- b** Hence find the coordinates of D .
- 16** **a** Let $A = (1, 4, 3)$ and $B = (2, -1, 5)$. Find M , the midpoint of AB .
- b** Use a similar method to find M , the midpoint of XY , where X and Y have coordinates (x_1, y_1, z_1) and (x_2, y_2, z_2) respectively.
- 17** Let $A = (5, 4, 1)$ and $B = (3, 1, -4)$. Find M on line segment AB such that $AM = 4MB$.
- 18** Let $A = (4, -3)$ and $B = (7, 1)$. Find N such that $\overrightarrow{AN} = 3\overrightarrow{BN}$.
- 19** Find the point P on the line $x - 6y = 11$ such that \overrightarrow{OP} is parallel to the vector $3\mathbf{i} + \mathbf{j}$.
- 20** The points A, B, C and D have position vectors $\mathbf{a}, \mathbf{b}, \mathbf{c}$ and \mathbf{d} respectively. Show that, if $ABCD$ is a parallelogram, then $\mathbf{a} + \mathbf{c} = \mathbf{b} + \mathbf{d}$.
- 21** Let $\mathbf{a} = 2\mathbf{i} + 2\mathbf{j}$, $\mathbf{b} = 3\mathbf{i} - \mathbf{j}$ and $\mathbf{c} = 4\mathbf{i} + 5\mathbf{j}$.
- a** Find:
- i** $\frac{1}{2}\mathbf{a}$ **ii** $\mathbf{b} - \mathbf{c}$ **iii** $3\mathbf{b} - \mathbf{a} - 2\mathbf{c}$
- b** Find values for k and ℓ such that $k\mathbf{a} + \ell\mathbf{b} = \mathbf{c}$.
- 22** Let $\mathbf{a} = 5\mathbf{i} + \mathbf{j} - 4\mathbf{k}$, $\mathbf{b} = 8\mathbf{i} - 2\mathbf{j} + \mathbf{k}$ and $\mathbf{c} = \mathbf{i} - 7\mathbf{j} + 6\mathbf{k}$.
- a** Find:
- i** $2\mathbf{a} - \mathbf{b}$ **ii** $\mathbf{a} + \mathbf{b} + \mathbf{c}$ **iii** $0.5\mathbf{a} + 0.4\mathbf{b}$
- b** Find values for k and ℓ such that $k\mathbf{a} + \ell\mathbf{b} = \mathbf{c}$.
- Example 15** **23** Let $\mathbf{a} = 5\mathbf{i} + 2\mathbf{j}$, $\mathbf{b} = 2\mathbf{i} - 3\mathbf{j}$, $\mathbf{c} = 2\mathbf{i} + \mathbf{j} + \mathbf{k}$ and $\mathbf{d} = -\mathbf{i} + 4\mathbf{j} + 2\mathbf{k}$.
- a** Find:
- i** $|\mathbf{a}|$ **ii** $|\mathbf{b}|$ **iii** $|\mathbf{a} + 2\mathbf{b}|$ **iv** $|\mathbf{c} - \mathbf{d}|$
- b** Find, correct to two decimal places, the angle which each of the following vectors makes with the positive direction of the x -axis:
- i** \mathbf{a} **ii** $\mathbf{a} + 2\mathbf{b}$ **iii** $\mathbf{c} - \mathbf{d}$

- Example 16** **24** The table gives the magnitudes of vectors in two dimensions and the angle they each make with the x -axis (measured anticlockwise). Express each of the vectors in terms of i and j , correct to two decimal places.

	Magnitude	Angle
a	10	110°
b	8.5	250°
c	6	40°
d	5	300°

- 25** The following table gives the magnitudes of vectors in three dimensions and the angles they each make with the x -, y - and z -axes, correct to two decimal places. Express each of the vectors in terms of i , j and k , correct to two decimal places.

	Magnitude	Angle with x -axis	Angle with y -axis	Angle with z -axis
a	10	130°	80°	41.75°
b	8	50°	54.52°	120°
c	7	28.93°	110°	110°
d	12	121.43°	35.5°	75.2°

- 26** Show that if a vector in three dimensions makes angles α , β and γ with the x -, y - and z -axes respectively, then $\cos^2 \alpha + \cos^2 \beta + \cos^2 \gamma = 1$.
- 27** Points A , B and C have position vectors $a = -2i + j + 5k$, $b = 2j + 3k$ and $c = -2i + 4j + 5k$ respectively. Let M be the midpoint of BC .
- a** Show that $\triangle ABC$ is isosceles. **b** Find \overrightarrow{OM} .
- c** Find \overrightarrow{AM} . **d** Find the area of $\triangle ABC$.
- 28** $OABCV$ is a square-based right pyramid with V the vertex. The base diagonals OB and AC intersect at the point M . If $\overrightarrow{OA} = 5i$, $\overrightarrow{OC} = 5j$ and $\overrightarrow{MV} = 3k$, find each of the following:
- a** \overrightarrow{OB} **b** \overrightarrow{OM} **c** \overrightarrow{OV} **d** \overrightarrow{BV} **e** $|\overrightarrow{OV}|$
- 29** Points A and B have position vectors a and b . Let M and N be the midpoints of OA and OB respectively, where O is the origin.
- a** Show that $\overrightarrow{MN} = \frac{1}{2}\overrightarrow{AB}$.
- b** Hence describe the geometric relationships between line segments MN and AB .

- Example 17** **30** Let i be the unit vector in the east direction and let j be the unit vector in the north direction, with units in kilometres. A runner sets off on a bearing of 120° .

- a** Find a unit vector in this direction.
- b** The runner covers 3 km. Find the position of the runner with respect to her starting point.
- c** The runner now turns and runs for 5 km in a northerly direction. Find the position of the runner with respect to her original starting point.
- d** Find the distance of the runner from her starting point.

- 31** A hang-glider jumps from a 50 m cliff.
- Give the position vector of point A with respect to O .
 - After a short period of time, the hang-glider has position B given by $\vec{OB} = -80\mathbf{i} + 20\mathbf{j} + 40\mathbf{k}$ metres.
 - Find the vector \vec{AB} .
 - Find the magnitude of \vec{AB} .
 - The hang-glider then moves 600 m in the \mathbf{j} -direction and 60 m in the \mathbf{k} -direction. Give the new position vector of the hang-glider.

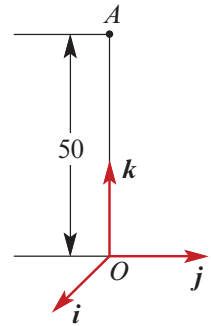

- 32** A light plane takes off (from a point which will be considered as the origin) so that its position after a short period of time is given by $r_1 = 1.5\mathbf{i} + 2\mathbf{j} + 0.9\mathbf{k}$, where \mathbf{i} is a unit vector in the east direction, \mathbf{j} is a unit vector in the north direction and measurements are in kilometres.
- Find the distance of the plane from the origin.
 - The position of a second plane at the same time is given by $r_2 = 2\mathbf{i} + 3\mathbf{j} + 0.8\mathbf{k}$.
 - Find $r_1 - r_2$.
 - Find the distance between the two aircraft.
 - Give a unit vector which would describe the direction in which the first plane must fly to pass over the origin at a height of 900 m.
- 33** Jan starts at a point O and walks on level ground 200 metres in a north-westerly direction to P . She then walks 50 metres due north to Q , which is at the bottom of a building. Jan then climbs to T , the top of the building, which is 30 metres vertically above Q . Let \mathbf{i} , \mathbf{j} and \mathbf{k} be unit vectors in the east, north and vertically upwards directions respectively. Express each of the following in terms of \mathbf{i} , \mathbf{j} and \mathbf{k} :
- \vec{OP}
 - \vec{PQ}
 - \vec{OQ}
 - \vec{QT}
 - \vec{OT}
- 34** A ship leaves a port and sails north-east for 100 km to a point P . Let \mathbf{i} and \mathbf{j} be the unit vectors in the east and north directions respectively, with units in kilometres.
- Find the position vector of point P .
 - If B is the point on the shore with position vector $\vec{OB} = 100\mathbf{i}$, find:
 - \vec{BP}
 - the bearing of P from B .
- 35** Given that $\mathbf{a} = \mathbf{i} - \mathbf{j} + 2\mathbf{k}$, $\mathbf{b} = \mathbf{i} + 2\mathbf{j} + m\mathbf{k}$ and $\mathbf{c} = 3\mathbf{i} + n\mathbf{j} + \mathbf{k}$ are linearly dependent, express m in terms of n in simplest fraction form.
- 36** Let $\mathbf{a} = \mathbf{i} - \mathbf{j} + 2\mathbf{k}$ and $\mathbf{b} = \mathbf{i} + 2\mathbf{j} - 4\mathbf{k}$.
- Find $2\mathbf{a} - 3\mathbf{b}$.
 - Hence find a value of m such that \mathbf{a} , \mathbf{b} and \mathbf{c} are linearly dependent, where $\mathbf{c} = m\mathbf{i} + 6\mathbf{j} - 12\mathbf{k}$.
- 37** Let $\mathbf{a} = 4\mathbf{i} - \mathbf{j} - 2\mathbf{k}$, $\mathbf{b} = \mathbf{i} - \mathbf{j} + \mathbf{k}$ and $\mathbf{c} = m\mathbf{a} + (1 - m)\mathbf{b}$.
- Find \mathbf{c} in terms of m .
 - Hence find p if $\mathbf{c} = 7\mathbf{i} - \mathbf{j} + p\mathbf{k}$.



5C Scalar product of vectors

The scalar product is an operation that takes two vectors and gives a real number.

Definition of the scalar product

We define the **scalar product** of two vectors in three dimensions $\mathbf{a} = a_1\mathbf{i} + a_2\mathbf{j} + a_3\mathbf{k}$ and $\mathbf{b} = b_1\mathbf{i} + b_2\mathbf{j} + b_3\mathbf{k}$ by

$$\mathbf{a} \cdot \mathbf{b} = a_1b_1 + a_2b_2 + a_3b_3$$

The scalar product of two vectors in two dimensions is defined similarly.

Note: If $\mathbf{a} = \mathbf{0}$ or $\mathbf{b} = \mathbf{0}$, then $\mathbf{a} \cdot \mathbf{b} = 0$.

The scalar product is often called the **dot product**.

Example 18

Let $\mathbf{a} = \mathbf{i} - 2\mathbf{j} + 3\mathbf{k}$ and $\mathbf{b} = -2\mathbf{i} + 3\mathbf{j} + 4\mathbf{k}$. Find:

a $\mathbf{a} \cdot \mathbf{b}$

b $\mathbf{a} \cdot \mathbf{a}$

Solution

a $\mathbf{a} \cdot \mathbf{b} = 1 \times (-2) + (-2) \times 3 + 3 \times 4 = 4$ **b** $\mathbf{a} \cdot \mathbf{a} = 1^2 + (-2)^2 + 3^2 = 14$

Geometric description of the scalar product

For vectors \mathbf{a} and \mathbf{b} , we have

$$\mathbf{a} \cdot \mathbf{b} = |\mathbf{a}||\mathbf{b}|\cos\theta$$

where θ is the angle between \mathbf{a} and \mathbf{b} .

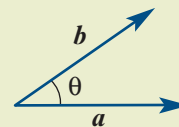

Proof Let $\mathbf{a} = a_1\mathbf{i} + a_2\mathbf{j} + a_3\mathbf{k}$ and $\mathbf{b} = b_1\mathbf{i} + b_2\mathbf{j} + b_3\mathbf{k}$. The cosine rule in $\triangle OAB$ gives

$$|\mathbf{a}|^2 + |\mathbf{b}|^2 - 2|\mathbf{a}||\mathbf{b}|\cos\theta = |\mathbf{a} - \mathbf{b}|^2$$

$$(a_1^2 + a_2^2 + a_3^2) + (b_1^2 + b_2^2 + b_3^2) - 2|\mathbf{a}||\mathbf{b}|\cos\theta = (a_1 - b_1)^2 + (a_2 - b_2)^2 + (a_3 - b_3)^2$$

$$2(a_1b_1 + a_2b_2 + a_3b_3) = 2|\mathbf{a}||\mathbf{b}|\cos\theta$$

$$a_1b_1 + a_2b_2 + a_3b_3 = |\mathbf{a}||\mathbf{b}|\cos\theta$$

$$\therefore \mathbf{a} \cdot \mathbf{b} = |\mathbf{a}||\mathbf{b}|\cos\theta$$

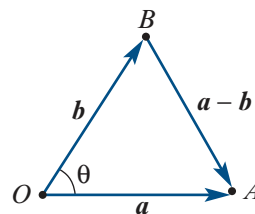

Note: When two non-zero vectors \mathbf{a} and \mathbf{b} are placed so that their initial points coincide, the angle θ between \mathbf{a} and \mathbf{b} is chosen as shown in the diagrams. Note that $0 \leq \theta \leq \pi$.

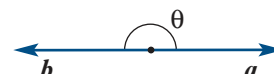
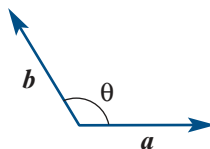
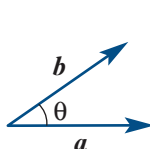

Example 19

- a** If $|a| = 4$, $|b| = 5$ and the angle between a and b is 30° , find $a \cdot b$.
b If $|a| = 4$, $|b| = 5$ and the angle between a and b is 150° , find $a \cdot b$.

Solution

a $a \cdot b = 4 \times 5 \times \cos 30^\circ$

$$= 20 \times \frac{\sqrt{3}}{2}$$

$$= 10\sqrt{3}$$

b $a \cdot b = 4 \times 5 \times \cos 150^\circ$

$$= 20 \times \frac{-\sqrt{3}}{2}$$

$$= -10\sqrt{3}$$

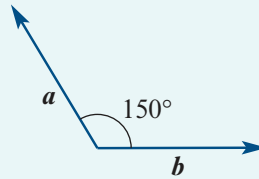
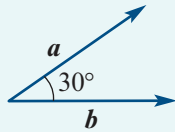

► **Properties of the scalar product**

- $a \cdot b = b \cdot a$
- $a \cdot (b + c) = a \cdot b + a \cdot c$
- If the vectors a and b are perpendicular, then $a \cdot b = 0$.
- If $a \cdot b = 0$ for non-zero vectors a and b , then the vectors a and b are perpendicular.
- For parallel vectors a and b , we have

$$a \cdot b = \begin{cases} |a||b| & \text{if } a \text{ and } b \text{ are parallel and in the same direction} \\ -|a||b| & \text{if } a \text{ and } b \text{ are parallel and in opposite directions} \end{cases}$$

- For the unit vectors i, j and k , we have $i \cdot i = j \cdot j = k \cdot k = 1$ and $i \cdot j = i \cdot k = j \cdot k = 0$.

Example 20

- a** Simplify $a \cdot (b + c) - b \cdot (a - c)$.
b Expand the following:
i $(a + b) \cdot (a + b)$ **ii** $(a + b) \cdot (a - b)$

Solution

a $a \cdot (b + c) - b \cdot (a - c) = a \cdot b + a \cdot c - b \cdot a + b \cdot c$

$$= a \cdot c + b \cdot c$$

b i $(a + b) \cdot (a + b) = a \cdot a + a \cdot b + b \cdot a + b \cdot b$

$$= a \cdot a + 2a \cdot b + b \cdot b$$

ii $(a + b) \cdot (a - b) = a \cdot a - a \cdot b + b \cdot a - b \cdot b$

$$= a \cdot a - b \cdot b$$

Example 21

Solve the equation $(\mathbf{i} + \mathbf{j} - \mathbf{k}) \cdot (3\mathbf{i} - x\mathbf{j} + 2\mathbf{k}) = 4$ for x .

Solution

$$\begin{aligned}(\mathbf{i} + \mathbf{j} - \mathbf{k}) \cdot (3\mathbf{i} - x\mathbf{j} + 2\mathbf{k}) &= 4 \\3 - x - 2 &= 4 \\1 - x &= 4 \\\therefore x &= -3\end{aligned}$$

► Finding the magnitude of the angle between two vectors

The angle between two vectors can be found by using the two forms of the scalar product:

$$\mathbf{a} \cdot \mathbf{b} = |\mathbf{a}||\mathbf{b}|\cos\theta \quad \text{and} \quad \mathbf{a} \cdot \mathbf{b} = a_1b_1 + a_2b_2 + a_3b_3$$

Therefore

$$\cos\theta = \frac{\mathbf{a} \cdot \mathbf{b}}{|\mathbf{a}||\mathbf{b}|} = \frac{a_1b_1 + a_2b_2 + a_3b_3}{|\mathbf{a}||\mathbf{b}|}$$

Example 22

A , B and C are points defined by the position vectors \mathbf{a} , \mathbf{b} and \mathbf{c} respectively, where

$$\mathbf{a} = \mathbf{i} + 3\mathbf{j} - \mathbf{k}, \quad \mathbf{b} = 2\mathbf{i} + \mathbf{j} \quad \text{and} \quad \mathbf{c} = \mathbf{i} - 2\mathbf{j} - 2\mathbf{k}$$

Find the magnitude of $\angle ABC$, correct to one decimal place.

Solution

$\angle ABC$ is the angle between vectors \overrightarrow{BA} and \overrightarrow{BC} .

$$\overrightarrow{BA} = \mathbf{a} - \mathbf{b} = -\mathbf{i} + 2\mathbf{j} - \mathbf{k}$$

$$\overrightarrow{BC} = \mathbf{c} - \mathbf{b} = -\mathbf{i} - 3\mathbf{j} - 2\mathbf{k}$$

We will apply the scalar product:

$$\overrightarrow{BA} \cdot \overrightarrow{BC} = |\overrightarrow{BA}||\overrightarrow{BC}|\cos(\angle ABC)$$

We have

$$\overrightarrow{BA} \cdot \overrightarrow{BC} = 1 - 6 + 2 = -3$$

$$|\overrightarrow{BA}| = \sqrt{1 + 4 + 1} = \sqrt{6}$$

$$|\overrightarrow{BC}| = \sqrt{1 + 9 + 4} = \sqrt{14}$$

Therefore

$$\cos(\angle ABC) = \frac{\overrightarrow{BA} \cdot \overrightarrow{BC}}{|\overrightarrow{BA}||\overrightarrow{BC}|} = \frac{-3}{\sqrt{6}\sqrt{14}}$$

Hence $\angle ABC = 109.1^\circ$, correct to one decimal place.

(Alternatively, we can write $\angle ABC = 1.9^\circ$, correct to one decimal place.)

Exercise 5C

Example 18

1 Let $\mathbf{a} = \mathbf{i} - 4\mathbf{j} + 7\mathbf{k}$, $\mathbf{b} = 2\mathbf{i} + 3\mathbf{j} + 3\mathbf{k}$ and $\mathbf{c} = -\mathbf{i} - 2\mathbf{j} + \mathbf{k}$. Find:

$$\begin{array}{llll} \mathbf{a} & \mathbf{a} \cdot \mathbf{a} & \mathbf{b} & \mathbf{b} \cdot \mathbf{b} & \mathbf{c} & \mathbf{c} \cdot \mathbf{c} & \mathbf{d} & \mathbf{a} \cdot \mathbf{b} \\ \mathbf{e} & \mathbf{a} \cdot (\mathbf{b} + \mathbf{c}) & \mathbf{f} & (\mathbf{a} + \mathbf{b}) \cdot (\mathbf{a} + \mathbf{c}) & \mathbf{g} & (\mathbf{a} + 2\mathbf{b}) \cdot (3\mathbf{c} - \mathbf{b}) \end{array}$$

2 Let $\mathbf{a} = 2\mathbf{i} - \mathbf{j} + 3\mathbf{k}$, $\mathbf{b} = 3\mathbf{i} - 2\mathbf{k}$ and $\mathbf{c} = -\mathbf{i} + 3\mathbf{j} - \mathbf{k}$. Find:

$$\begin{array}{lll} \mathbf{a} & \mathbf{a} \cdot \mathbf{a} & \mathbf{b} & \mathbf{b} \cdot \mathbf{b} & \mathbf{c} & \mathbf{a} \cdot \mathbf{b} \\ \mathbf{d} & \mathbf{a} \cdot \mathbf{c} & \mathbf{e} & \mathbf{a} \cdot (\mathbf{a} + \mathbf{b}) \end{array}$$

Example 19

3 **a** If $|\mathbf{a}| = 6$, $|\mathbf{b}| = 7$ and the angle between \mathbf{a} and \mathbf{b} is 60° , find $\mathbf{a} \cdot \mathbf{b}$.
b If $|\mathbf{a}| = 6$, $|\mathbf{b}| = 7$ and the angle between \mathbf{a} and \mathbf{b} is 120° , find $\mathbf{a} \cdot \mathbf{b}$.

Example 20

4 Expand and simplify:

$$\begin{array}{ll} \mathbf{a} & (\mathbf{a} + 2\mathbf{b}) \cdot (\mathbf{a} + 2\mathbf{b}) & \mathbf{b} & |\mathbf{a} + \mathbf{b}|^2 - |\mathbf{a} - \mathbf{b}|^2 \\ \mathbf{c} & \mathbf{a} \cdot (\mathbf{a} + \mathbf{b}) - \mathbf{b} \cdot (\mathbf{a} + \mathbf{b}) & \mathbf{d} & \frac{\mathbf{a} \cdot (\mathbf{a} + \mathbf{b}) - \mathbf{a} \cdot \mathbf{b}}{|\mathbf{a}|} \end{array}$$

Example 21

5 Solve each of the following equations:

$$\begin{array}{ll} \mathbf{a} & (\mathbf{i} + 2\mathbf{j} - 3\mathbf{k}) \cdot (5\mathbf{i} + x\mathbf{j} + \mathbf{k}) = -6 & \mathbf{b} & (x\mathbf{i} + 7\mathbf{j} - \mathbf{k}) \cdot (-4\mathbf{i} + x\mathbf{j} + 5\mathbf{k}) = 10 \\ \mathbf{c} & (x\mathbf{i} + 5\mathbf{k}) \cdot (-2\mathbf{i} - 3\mathbf{j} + 3\mathbf{k}) = x & \mathbf{d} & x(2\mathbf{i} + 3\mathbf{j} + \mathbf{k}) \cdot (\mathbf{i} + \mathbf{j} + x\mathbf{k}) = 6 \end{array}$$

Example 22

6 If A and B are points defined by the position vectors $\mathbf{a} = \mathbf{i} + 2\mathbf{j} - \mathbf{k}$ and $\mathbf{b} = -\mathbf{i} + \mathbf{j} - 3\mathbf{k}$ respectively, find:

$$\mathbf{a} \quad \overrightarrow{AB} \quad \mathbf{b} \quad |\overrightarrow{AB}| \quad \mathbf{c} \quad \text{the magnitude of the angle between vectors } \overrightarrow{AB} \text{ and } \mathbf{a}.$$

7 Let C and D be points with position vectors \mathbf{c} and \mathbf{d} respectively. If $|\mathbf{c}| = 5$, $|\mathbf{d}| = 7$ and $\mathbf{c} \cdot \mathbf{d} = 4$, find $|\overrightarrow{CD}|$.8 $OABC$ is a rhombus with $\overrightarrow{OA} = \mathbf{a}$ and $\overrightarrow{OC} = \mathbf{c}$.**a** Express the following vectors in terms of \mathbf{a} and \mathbf{c} :

$$\mathbf{i} \quad \overrightarrow{AB} \quad \mathbf{ii} \quad \overrightarrow{OB} \quad \mathbf{iii} \quad \overrightarrow{AC}$$

b Find $\overrightarrow{OB} \cdot \overrightarrow{AC}$.**c** Prove that the diagonals of a rhombus intersect at right angles.

9 From the following list, find three pairs of perpendicular vectors:

$$\mathbf{a} = \mathbf{i} + 3\mathbf{j} - \mathbf{k}$$

$$\mathbf{b} = -4\mathbf{i} + \mathbf{j} + 2\mathbf{k}$$

$$\mathbf{c} = -2\mathbf{i} - 2\mathbf{j} - 3\mathbf{k}$$

$$\mathbf{d} = -\mathbf{i} + \mathbf{j} + \mathbf{k}$$

$$\mathbf{e} = 2\mathbf{i} - \mathbf{j} - \mathbf{k}$$

$$\mathbf{f} = -\mathbf{i} + 4\mathbf{j} - 5\mathbf{k}$$

- 10** Points A and B are defined by the position vectors $\mathbf{a} = \mathbf{i} + 4\mathbf{j} - 4\mathbf{k}$ and $\mathbf{b} = 2\mathbf{i} + 5\mathbf{j} - \mathbf{k}$.
Let P be the point on OB such that AP is perpendicular to OB .
Then $\overrightarrow{OP} = q\mathbf{b}$, for a constant q .

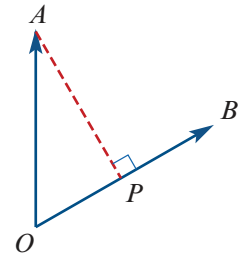

- a** Express \overrightarrow{AP} in terms of q , \mathbf{a} and \mathbf{b} .
b Use the fact that $\overrightarrow{AP} \cdot \overrightarrow{OB} = 0$ to find the value of q .
c Find the coordinates of the point P .
- 11** If $x\mathbf{i} + 2\mathbf{j} + y\mathbf{k}$ is perpendicular to vectors $\mathbf{i} + \mathbf{j} + \mathbf{k}$ and $4\mathbf{i} + \mathbf{j} + 2\mathbf{k}$, find x and y .
- 12** Find the angle, in radians, between each of the following pairs of vectors, correct to three significant figures:
- a** $\mathbf{i} + 2\mathbf{j} - \mathbf{k}$ and $\mathbf{i} - 4\mathbf{j} + \mathbf{k}$ **b** $-2\mathbf{i} + \mathbf{j} + 3\mathbf{k}$ and $-2\mathbf{i} - 2\mathbf{j} + \mathbf{k}$
c $2\mathbf{i} - \mathbf{j} - 3\mathbf{k}$ and $4\mathbf{i} - 2\mathbf{k}$ **d** $7\mathbf{i} + \mathbf{k}$ and $-\mathbf{i} + \mathbf{j} - 3\mathbf{k}$
- 13** Let \mathbf{a} and \mathbf{b} be non-zero vectors such that $\mathbf{a} \cdot \mathbf{b} = 0$. Use the geometric description of the scalar product to show that \mathbf{a} and \mathbf{b} are perpendicular vectors.

For Questions 14–17, find the angles in degrees correct to two decimal places.

- 14** Let A and B be the points defined by the position vectors $\mathbf{a} = \mathbf{i} + \mathbf{j} + \mathbf{k}$ and $\mathbf{b} = 2\mathbf{i} + \mathbf{j} - \mathbf{k}$ respectively. Let M be the midpoint of AB . Find:

a \overrightarrow{OM} **b** $\angle AOM$ **c** $\angle BMO$

- 15** $OABCDEFG$ is a cuboid, set on axes at O , such that $\overrightarrow{OD} = \mathbf{i}$, $\overrightarrow{OA} = 3\mathbf{j}$ and $\overrightarrow{OC} = 2\mathbf{k}$. Find:

a **i** \overrightarrow{GB} **ii** \overrightarrow{GE}
b $\angle BGE$
c the angle between diagonals \overrightarrow{CE} and \overrightarrow{GA}

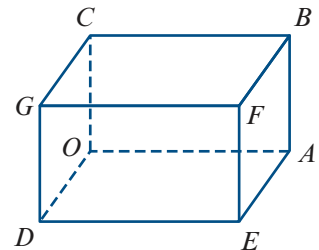

- 16** Let A , B and C be the points defined by the position vectors $4\mathbf{i}$, $5\mathbf{j}$ and $-2\mathbf{i} + 7\mathbf{k}$ respectively. Let M and N be the midpoints of AB and AC respectively. Find:

a **i** \overrightarrow{OM} **ii** \overrightarrow{ON} **b** $\angle MON$ **c** $\angle MOC$

- 17** A parallelepiped is an oblique prism that has a parallelogram cross-section. It has three pairs of parallel and congruent faces.

$OABCDEFG$ is a parallelepiped with $\overrightarrow{OA} = 3\mathbf{j}$, $\overrightarrow{OC} = -\mathbf{i} + \mathbf{j} + 2\mathbf{k}$ and $\overrightarrow{OD} = 2\mathbf{i} - \mathbf{j}$.

Show that the diagonals DB and CE bisect each other, and find the acute angle between them.

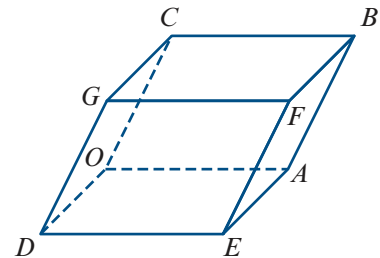

5D Vector projections

It is often useful to decompose a vector \mathbf{a} into a sum of two vectors, one parallel to a given vector \mathbf{b} and the other perpendicular to \mathbf{b} .

From the diagram, it can be seen that

$$\mathbf{a} = \mathbf{u} + \mathbf{w}$$

where $\mathbf{u} = k\mathbf{b}$ and so $\mathbf{w} = \mathbf{a} - \mathbf{u} = \mathbf{a} - k\mathbf{b}$.

For \mathbf{w} to be perpendicular to \mathbf{b} , we must have

$$\mathbf{w} \cdot \mathbf{b} = 0$$

$$(\mathbf{a} - k\mathbf{b}) \cdot \mathbf{b} = 0$$

$$\mathbf{a} \cdot \mathbf{b} - k(\mathbf{b} \cdot \mathbf{b}) = 0$$

Hence $k = \frac{\mathbf{a} \cdot \mathbf{b}}{\mathbf{b} \cdot \mathbf{b}}$ and therefore $\mathbf{u} = \frac{\mathbf{a} \cdot \mathbf{b}}{\mathbf{b} \cdot \mathbf{b}} \mathbf{b}$.

This vector \mathbf{u} is called the **vector projection** (or **vector resolute**) of \mathbf{a} in the direction of \mathbf{b} .

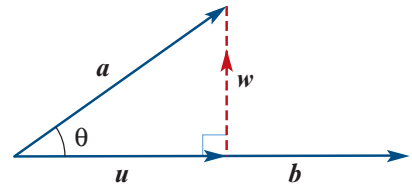

Vector resolute

The **vector resolute** of \mathbf{a} in the direction of \mathbf{b} can be expressed in any one of the following equivalent forms:

$$\mathbf{u} = \frac{\mathbf{a} \cdot \mathbf{b}}{\mathbf{b} \cdot \mathbf{b}} \mathbf{b} = \frac{\mathbf{a} \cdot \mathbf{b}}{|\mathbf{b}|^2} \mathbf{b} = \left(\mathbf{a} \cdot \frac{\mathbf{b}}{|\mathbf{b}|} \right) \left(\frac{\mathbf{b}}{|\mathbf{b}|} \right) = (\mathbf{a} \cdot \hat{\mathbf{b}}) \hat{\mathbf{b}}$$

Note: The quantity $\mathbf{a} \cdot \hat{\mathbf{b}} = \frac{\mathbf{a} \cdot \mathbf{b}}{|\mathbf{b}|}$ is the ‘signed length’ of the vector resolute \mathbf{u} and is called the **scalar resolute** of \mathbf{a} in the direction of \mathbf{b} .

Note that, from our previous calculation, we have $\mathbf{w} = \mathbf{a} - \mathbf{u} = \mathbf{a} - \frac{\mathbf{a} \cdot \mathbf{b}}{\mathbf{b} \cdot \mathbf{b}} \mathbf{b}$.

Expressing \mathbf{a} as the sum of the two components, the first parallel to \mathbf{b} and the second perpendicular to \mathbf{b} , gives

$$\mathbf{a} = \frac{\mathbf{a} \cdot \mathbf{b}}{\mathbf{b} \cdot \mathbf{b}} \mathbf{b} + \left(\mathbf{a} - \frac{\mathbf{a} \cdot \mathbf{b}}{\mathbf{b} \cdot \mathbf{b}} \mathbf{b} \right)$$

This is sometimes described as resolving the vector \mathbf{a} into **rectangular components**.

Example 23

Let $\mathbf{a} = \mathbf{i} + 3\mathbf{j} - \mathbf{k}$ and $\mathbf{b} = \mathbf{i} - \mathbf{j} + 2\mathbf{k}$. Find the vector resolute of:

a \mathbf{a} in the direction of \mathbf{b}

b \mathbf{b} in the direction of \mathbf{a} .

Solution

a $\mathbf{a} \cdot \mathbf{b} = 1 - 3 - 2 = -4$, $\mathbf{b} \cdot \mathbf{b} = 1 + 1 + 4 = 6$

The vector resolute of \mathbf{a} in the direction of \mathbf{b} is

$$\frac{\mathbf{a} \cdot \mathbf{b}}{\mathbf{b} \cdot \mathbf{b}} \mathbf{b} = -\frac{4}{6}(\mathbf{i} - \mathbf{j} + 2\mathbf{k}) = -\frac{2}{3}(\mathbf{i} - \mathbf{j} + 2\mathbf{k})$$

$$\mathbf{b} \cdot \mathbf{a} = \mathbf{a} \cdot \mathbf{b} = -4, \quad \mathbf{a} \cdot \mathbf{a} = 1 + 9 + 1 = 11$$

The vector resolute of \mathbf{b} in the direction of \mathbf{a} is

$$\frac{\mathbf{b} \cdot \mathbf{a}}{\mathbf{a} \cdot \mathbf{a}} \mathbf{a} = -\frac{4}{11}(\mathbf{i} + 3\mathbf{j} - \mathbf{k})$$

Example 24

Find the scalar resolute of $\mathbf{a} = 2\mathbf{i} + 2\mathbf{j} - \mathbf{k}$ in the direction of $\mathbf{b} = -\mathbf{i} + 3\mathbf{k}$.

Solution

$$\mathbf{a} \cdot \mathbf{b} = -2 - 3 = -5$$

$$|\mathbf{b}| = \sqrt{1 + 9} = \sqrt{10}$$

The scalar resolute of \mathbf{a} in the direction of \mathbf{b} is

$$\frac{\mathbf{a} \cdot \mathbf{b}}{|\mathbf{b}|} = \frac{-5}{\sqrt{10}} = -\frac{\sqrt{10}}{2}$$



Example 25

Resolve $\mathbf{i} + 3\mathbf{j} - \mathbf{k}$ into rectangular components, one of which is parallel to $2\mathbf{i} - 2\mathbf{j} - \mathbf{k}$.

Solution

Let $\mathbf{a} = \mathbf{i} + 3\mathbf{j} - \mathbf{k}$ and $\mathbf{b} = 2\mathbf{i} - 2\mathbf{j} - \mathbf{k}$.

The vector resolute of \mathbf{a} in the direction of \mathbf{b} is given by $\frac{\mathbf{a} \cdot \mathbf{b}}{\mathbf{b} \cdot \mathbf{b}} \mathbf{b}$.

We have

$$\mathbf{a} \cdot \mathbf{b} = 2 - 6 + 1 = -3$$

$$\mathbf{b} \cdot \mathbf{b} = 4 + 4 + 1 = 9$$

Therefore the vector resolute is

$$\frac{-3}{9}(2\mathbf{i} - 2\mathbf{j} - \mathbf{k}) = -\frac{1}{3}(2\mathbf{i} - 2\mathbf{j} - \mathbf{k})$$

The perpendicular component is

$$\begin{aligned} \mathbf{a} - \left(-\frac{1}{3}(2\mathbf{i} - 2\mathbf{j} - \mathbf{k})\right) &= (\mathbf{i} + 3\mathbf{j} - \mathbf{k}) + \frac{1}{3}(2\mathbf{i} - 2\mathbf{j} - \mathbf{k}) \\ &= \frac{5}{3}\mathbf{i} + \frac{7}{3}\mathbf{j} - \frac{4}{3}\mathbf{k} \\ &= \frac{1}{3}(5\mathbf{i} + 7\mathbf{j} - 4\mathbf{k}) \end{aligned}$$

Hence we can write

$$\mathbf{i} + 3\mathbf{j} - \mathbf{k} = -\frac{1}{3}(2\mathbf{i} - 2\mathbf{j} - \mathbf{k}) + \frac{1}{3}(5\mathbf{i} + 7\mathbf{j} - 4\mathbf{k})$$

Check: As a check, we verify that the second component is indeed perpendicular to \mathbf{b} .

We have $(5\mathbf{i} + 7\mathbf{j} - 4\mathbf{k}) \cdot (2\mathbf{i} - 2\mathbf{j} - \mathbf{k}) = 10 - 14 + 4 = 0$, as expected.

Exercise 5D

Skillsheet

- 1 Points A and B are defined by the position vectors $\mathbf{a} = \mathbf{i} + 3\mathbf{j} - \mathbf{k}$ and $\mathbf{b} = \mathbf{i} + 2\mathbf{j} + 2\mathbf{k}$.
- a** Find $\hat{\mathbf{a}}$. **b** Find $\hat{\mathbf{b}}$. **c** Find $\hat{\mathbf{c}}$, where $\mathbf{c} = \overrightarrow{AB}$.

- 2 Let $\mathbf{a} = 3\mathbf{i} + 4\mathbf{j} - \mathbf{k}$ and $\mathbf{b} = \mathbf{i} - \mathbf{j} - \mathbf{k}$.

a Find:

i $\hat{\mathbf{a}}$ **ii** $\hat{\mathbf{b}}$

b Find the vector with the same magnitude as \mathbf{b} and with the same direction as \mathbf{a} .

- 3 Points A and B are defined by the position vectors $\mathbf{a} = 2\mathbf{i} - 2\mathbf{j} - \mathbf{k}$ and $\mathbf{b} = 3\mathbf{i} + 4\mathbf{k}$.

a Find:

i $\hat{\mathbf{a}}$ **ii** $\hat{\mathbf{b}}$

b Find the unit vector which bisects $\angle AOB$.

Example 23

- 4 For each pair of vectors, find the vector resolute of \mathbf{a} in the direction of \mathbf{b} :

a $\mathbf{a} = \mathbf{i} + 3\mathbf{j}$ and $\mathbf{b} = \mathbf{i} - 4\mathbf{j} + \mathbf{k}$

b $\mathbf{a} = \mathbf{i} - 3\mathbf{k}$ and $\mathbf{b} = \mathbf{i} - 4\mathbf{j} + \mathbf{k}$

c $\mathbf{a} = 4\mathbf{i} - \mathbf{j} + 3\mathbf{k}$ and $\mathbf{b} = 4\mathbf{i} - \mathbf{k}$

Example 24

- 5 For each of the following pairs of vectors, find the scalar resolute of the first vector in the direction of the second vector:

a $\mathbf{a} = 2\mathbf{i} + \mathbf{j}$ and $\mathbf{b} = \mathbf{i}$

b $\mathbf{a} = 3\mathbf{i} + \mathbf{j} - 3\mathbf{k}$ and $\mathbf{c} = \mathbf{i} - 2\mathbf{j}$

c $\mathbf{b} = 2\mathbf{j} + \mathbf{k}$ and $\mathbf{a} = 2\mathbf{i} + \sqrt{3}\mathbf{j}$

d $\mathbf{b} = \mathbf{i} - \sqrt{5}\mathbf{j}$ and $\mathbf{c} = -\mathbf{i} + 4\mathbf{j}$

Example 25

- 6 For each of the following pairs of vectors, find the resolution of the vector \mathbf{a} into rectangular components, one of which is parallel to \mathbf{b} :

a $\mathbf{a} = 2\mathbf{i} + \mathbf{j} + \mathbf{k}$, $\mathbf{b} = 5\mathbf{i} - \mathbf{k}$

b $\mathbf{a} = 3\mathbf{i} + \mathbf{j}$, $\mathbf{b} = \mathbf{i} + \mathbf{k}$

c $\mathbf{a} = -\mathbf{i} + \mathbf{j} + \mathbf{k}$, $\mathbf{b} = 2\mathbf{i} + 2\mathbf{j} - \mathbf{k}$

- 7 Let A and B be the points defined by the position vectors $\mathbf{a} = \mathbf{i} + 3\mathbf{j} - \mathbf{k}$ and $\mathbf{b} = \mathbf{j} + \mathbf{k}$ respectively. Find:

a the vector resolute of \mathbf{a} in the direction of \mathbf{b}

b a unit vector through A perpendicular to OB

- 8 Let A and B be the points defined by the position vectors $\mathbf{a} = 4\mathbf{i} + \mathbf{j}$ and $\mathbf{b} = \mathbf{i} - \mathbf{j} - \mathbf{k}$ respectively. Find:

a the vector resolute of \mathbf{a} in the direction of \mathbf{b}

b the vector component of \mathbf{a} perpendicular to \mathbf{b}

c the shortest distance from A to line OB

- 9 Points A , B and C have position vectors $\mathbf{a} = \mathbf{i} + 2\mathbf{j} + \mathbf{k}$, $\mathbf{b} = 2\mathbf{i} + \mathbf{j} - \mathbf{k}$ and $\mathbf{c} = 2\mathbf{i} - 3\mathbf{j} + \mathbf{k}$. Find:

a i \overrightarrow{AB} ii \overrightarrow{AC}

b the vector resolute of \overrightarrow{AB} in the direction of \overrightarrow{AC}

c the shortest distance from B to line AC

d the area of triangle ABC

- 10 a Verify that vectors $\mathbf{a} = \mathbf{i} - 3\mathbf{j} - 2\mathbf{k}$ and $\mathbf{b} = 5\mathbf{i} + \mathbf{j} + \mathbf{k}$ are perpendicular to each other.

b If $\mathbf{c} = 2\mathbf{i} - \mathbf{k}$, find:

i \mathbf{d} , the vector resolute of \mathbf{c} in the direction of \mathbf{a}

ii \mathbf{e} , the vector resolute of \mathbf{c} in the direction of \mathbf{b} .

c Find \mathbf{f} such that $\mathbf{c} = \mathbf{d} + \mathbf{e} + \mathbf{f}$.

d Hence show that \mathbf{f} is perpendicular to both vectors \mathbf{a} and \mathbf{b} .



5E Collinearity

Three or more points are **collinear** if they all lie on a single line.



Three distinct points A , B and C are collinear if and only if there exists a non-zero real number m such that $\overrightarrow{AC} = m\overrightarrow{AB}$ (that is, if and only if \overrightarrow{AB} and \overrightarrow{AC} are parallel).

A property of collinearity

Let points A , B and C have position vectors $\mathbf{a} = \overrightarrow{OA}$, $\mathbf{b} = \overrightarrow{OB}$ and $\mathbf{c} = \overrightarrow{OC}$. Then

$$\overrightarrow{AC} = m\overrightarrow{AB} \quad \text{if and only if} \quad \mathbf{c} = (1 - m)\mathbf{a} + m\mathbf{b}$$

Proof If $\overrightarrow{AC} = m\overrightarrow{AB}$, then we have

$$\begin{aligned} \mathbf{c} &= \overrightarrow{OA} + \overrightarrow{AC} \\ &= \overrightarrow{OA} + m\overrightarrow{AB} \\ &= \mathbf{a} + m(\mathbf{b} - \mathbf{a}) \\ &= \mathbf{a} + m\mathbf{b} - m\mathbf{a} \\ &= (1 - m)\mathbf{a} + m\mathbf{b} \end{aligned}$$

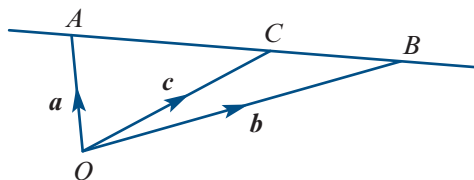

Similarly, we can show that if $\mathbf{c} = (1 - m)\mathbf{a} + m\mathbf{b}$, then $\overrightarrow{AC} = m\overrightarrow{AB}$.

Note: It follows from this result that if distinct points A , B and C are collinear, then we can write $\overrightarrow{OC} = \lambda\overrightarrow{OA} + \mu\overrightarrow{OB}$, where $\lambda + \mu = 1$. If C is between A and B , then $0 < \mu < 1$.

Example 26

For distinct points A and B , let $\mathbf{a} = \overrightarrow{OA}$ and $\mathbf{b} = \overrightarrow{OB}$. Express \overrightarrow{OC} in terms of \mathbf{a} and \mathbf{b} , where C is:

- a** the midpoint of AB
- b** the point of trisection of AB nearer to A
- c** the point C such that $\overrightarrow{AC} = -2\overrightarrow{AB}$.

Solution

$$\mathbf{a} \quad \overrightarrow{AC} = \frac{1}{2}\overrightarrow{AB}$$

$$\mathbf{b} \quad \overrightarrow{AC} = \frac{1}{3}\overrightarrow{AB}$$

$$\mathbf{c} \quad \overrightarrow{AC} = -2\overrightarrow{AB}$$

$$\overrightarrow{OC} = \overrightarrow{OA} + \overrightarrow{AC}$$

$$= \mathbf{a} + \frac{1}{2}\overrightarrow{AB}$$

$$= \mathbf{a} + \frac{1}{2}(\mathbf{b} - \mathbf{a})$$

$$= \frac{1}{2}(\mathbf{a} + \mathbf{b})$$

$$\overrightarrow{OC} = \overrightarrow{OA} + \overrightarrow{AC}$$

$$= \mathbf{a} + \frac{1}{3}\overrightarrow{AB}$$

$$= \mathbf{a} + \frac{1}{3}(\mathbf{b} - \mathbf{a})$$

$$= \frac{2}{3}\mathbf{a} + \frac{1}{3}\mathbf{b}$$

$$\overrightarrow{OC} = \overrightarrow{OA} + \overrightarrow{AC}$$

$$= \mathbf{a} - 2\overrightarrow{AB}$$

$$= \mathbf{a} - 2(\mathbf{b} - \mathbf{a})$$

$$= 3\mathbf{a} - 2\mathbf{b}$$

Note: Alternatively, we could have used the previous result in this example.

Example 27

Let $\overrightarrow{OA} = \mathbf{a}$ and $\overrightarrow{OB} = \mathbf{b}$, where vectors \mathbf{a} and \mathbf{b} are linearly independent.

Let M be the midpoint of OA , let C be the point such that $\overrightarrow{OC} = \frac{4}{3}\overrightarrow{OB}$ and let R be the point of intersection of lines AB and MC .

- a** Find \overrightarrow{OR} in terms of \mathbf{a} and \mathbf{b} .
- b** Hence find $AR : RB$.

Solution

$$\mathbf{a} \quad \text{We have } \overrightarrow{OM} = \frac{1}{2}\mathbf{a} \text{ and } \overrightarrow{OC} = \frac{4}{3}\mathbf{b}.$$

Since M , R and C are collinear, there exists $m \in \mathbb{R}$ with

$$\begin{aligned} \overrightarrow{MR} &= m\overrightarrow{MC} \\ &= m(\overrightarrow{MO} + \overrightarrow{OC}) \\ &= m\left(-\frac{1}{2}\mathbf{a} + \frac{4}{3}\mathbf{b}\right) \end{aligned}$$

$$\begin{aligned} \text{Thus } \overrightarrow{OR} &= \overrightarrow{OM} + \overrightarrow{MR} \\ &= \frac{1}{2}\mathbf{a} + m\left(-\frac{1}{2}\mathbf{a} + \frac{4}{3}\mathbf{b}\right) \\ &= \frac{1-m}{2}\mathbf{a} + \frac{4m}{3}\mathbf{b} \end{aligned}$$

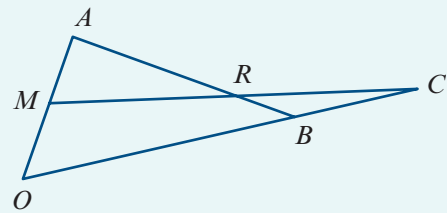

Since A , R and B are collinear, there exists $n \in \mathbb{R}$ with

$$\begin{aligned}\overrightarrow{AR} &= n\overrightarrow{AB} \\ &= n(\overrightarrow{AO} + \overrightarrow{OB}) \\ &= n(-\mathbf{a} + \mathbf{b})\end{aligned}$$

$$\begin{aligned}\text{Thus } \overrightarrow{OR} &= \overrightarrow{OA} + \overrightarrow{AR} \\ &= \mathbf{a} + n(-\mathbf{a} + \mathbf{b}) \\ &= (1 - n)\mathbf{a} + n\mathbf{b}\end{aligned}$$

Hence, since \mathbf{a} and \mathbf{b} are linearly independent, we have

$$\frac{1 - m}{2} = 1 - n \quad \text{and} \quad \frac{4m}{3} = n$$

This gives $m = \frac{3}{5}$ and $n = \frac{4}{5}$. Therefore

$$\overrightarrow{OR} = \frac{1}{5}\mathbf{a} + \frac{4}{5}\mathbf{b}$$

b From part **a**, we have

$$\begin{aligned}\overrightarrow{AR} &= \overrightarrow{AO} + \overrightarrow{OR} \\ &= -\mathbf{a} + \frac{1}{5}\mathbf{a} + \frac{4}{5}\mathbf{b} \\ &= \frac{4}{5}(\mathbf{b} - \mathbf{a}) \\ &= \frac{4}{5}\overrightarrow{AB}\end{aligned}$$

Hence $AR : RB = 4 : 1$.

Exercise 5E

Example 26

1 Points A , B and R are collinear, with $\overrightarrow{OA} = \mathbf{a}$ and $\overrightarrow{OB} = \mathbf{b}$. Express \overrightarrow{OR} in terms of \mathbf{a} and \mathbf{b} , where R is the point:

- a** of trisection of AB nearer to B
- b** between A and B such that $AR : AB = 3 : 2$.

2 Let $\overrightarrow{OA} = 3\mathbf{i} + 4\mathbf{k}$ and $\overrightarrow{OB} = 2\mathbf{i} - 2\mathbf{j} + \mathbf{k}$. Find \overrightarrow{OR} , where R is:

- a** the midpoint of line segment AB
- b** the point such that $\overrightarrow{AR} = \frac{4}{3}\overrightarrow{AB}$
- c** the point such that $\overrightarrow{AR} = -\frac{1}{3}\overrightarrow{AB}$.

- 3** The position vectors of points P , Q and R are \mathbf{a} , $3\mathbf{a} - 4\mathbf{b}$ and $4\mathbf{a} - 6\mathbf{b}$ respectively.
- Show that P , Q and R are collinear.
 - Find $PQ : QR$.
- 4** In triangle OAB , $\overrightarrow{OA} = a\mathbf{i}$ and $\overrightarrow{OB} = x\mathbf{i} + y\mathbf{j}$. Let C be the midpoint of AB .
- Find \overrightarrow{OC} .
 - Deduce, by vector method, the relationship between x , y and a if the vector \overrightarrow{OC} is perpendicular to \overrightarrow{AB} .
- 5** In parallelogram $OAUB$, $\overrightarrow{OA} = \mathbf{a}$ and $\overrightarrow{OB} = \mathbf{b}$. Let $\overrightarrow{OM} = \frac{1}{5}\mathbf{a}$ and $MP : PB = 1 : 5$, where P is on the line segment MB .
- Prove that P is on the diagonal OU .
 - Hence find $OP : PU$.
- 6** $OABC$ is a square with $\overrightarrow{OA} = -4\mathbf{i} + 3\mathbf{j}$ and $\overrightarrow{OC} = 3\mathbf{i} + 4\mathbf{j}$.
- Find \overrightarrow{OB} .
 - Given that D is the point on AB such that $\overrightarrow{BD} = \frac{1}{3}\overrightarrow{BA}$, find \overrightarrow{OD} .
 - Given that OD intersects AC at E and that $\overrightarrow{OE} = (1 - \lambda)\overrightarrow{OA} + \lambda\overrightarrow{OC}$, find λ .
- 7** In triangle OAB , $\overrightarrow{OA} = 3\mathbf{i} + 4\mathbf{k}$ and $\overrightarrow{OB} = \mathbf{i} + 2\mathbf{j} - 2\mathbf{k}$.
- Use the scalar product to show that $\angle AOB$ is an obtuse angle.
 - Find \overrightarrow{OP} , where P is:
 - the midpoint of AB
 - the point on AB such that OP is perpendicular to AB
 - the point where the bisector of $\angle AOB$ intersects AB .



5F Geometric proofs

In this section we use vectors to prove geometric results. The following properties of vectors will be useful:

- For $k \in \mathbb{R}^+$, the vector $k\mathbf{a}$ is in the same direction as \mathbf{a} and has magnitude $k|\mathbf{a}|$, and the vector $-\mathbf{ka}$ is in the opposite direction to \mathbf{a} and has magnitude $k|\mathbf{a}|$.
- If vectors \mathbf{a} and \mathbf{b} are parallel, then $\mathbf{b} = k\mathbf{a}$ for some $k \in \mathbb{R} \setminus \{0\}$. Conversely, if \mathbf{a} and \mathbf{b} are non-zero vectors such that $\mathbf{b} = k\mathbf{a}$ for some $k \in \mathbb{R} \setminus \{0\}$, then \mathbf{a} and \mathbf{b} are parallel.
- If $\overrightarrow{AB} = k\overrightarrow{BC}$ for some $k \in \mathbb{R} \setminus \{0\}$, then A , B and C are collinear.
- Two non-zero vectors \mathbf{a} and \mathbf{b} are perpendicular if and only if $\mathbf{a} \cdot \mathbf{b} = 0$.
- $\mathbf{a} \cdot \mathbf{a} = |\mathbf{a}|^2$

Example 28

Prove that the diagonals of a rhombus are perpendicular.

Solution

$OABC$ is a rhombus.

Let $\mathbf{a} = \overrightarrow{OA}$ and $\mathbf{c} = \overrightarrow{OC}$.

The diagonals of the rhombus are OB and AC .

Now $\overrightarrow{OB} = \overrightarrow{OC} + \overrightarrow{CB}$

$$= \overrightarrow{OC} + \overrightarrow{OA}$$

$$= \mathbf{c} + \mathbf{a}$$

and $\overrightarrow{AC} = \overrightarrow{AO} + \overrightarrow{OC}$

$$= -\mathbf{a} + \mathbf{c}$$

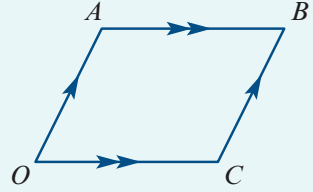

Consider the scalar product of \overrightarrow{OB} and \overrightarrow{AC} :

$$\overrightarrow{OB} \cdot \overrightarrow{AC} = (\mathbf{c} + \mathbf{a}) \cdot (\mathbf{c} - \mathbf{a})$$

$$= \mathbf{c} \cdot \mathbf{c} - \mathbf{a} \cdot \mathbf{a}$$

$$= |\mathbf{c}|^2 - |\mathbf{a}|^2$$

A rhombus has all sides of equal length, and therefore $|\mathbf{c}| = |\mathbf{a}|$. Hence

$$\overrightarrow{OB} \cdot \overrightarrow{AC} = |\mathbf{c}|^2 - |\mathbf{a}|^2 = 0$$

This implies that AC is perpendicular to OB .

Example 29

Prove that the angle subtended by a diameter in a circle is a right angle.

Solution

Let O be the centre of the circle and let AB be a diameter.

Then $|\overrightarrow{OA}| = |\overrightarrow{OB}| = |\overrightarrow{OC}| = r$, where r is the radius.

Let $\mathbf{a} = \overrightarrow{OA}$ and $\mathbf{c} = \overrightarrow{OC}$. Then $\overrightarrow{OB} = -\mathbf{a}$.

We have $\overrightarrow{AC} = \overrightarrow{AO} + \overrightarrow{OC}$ and $\overrightarrow{BC} = \overrightarrow{BO} + \overrightarrow{OC}$.

Thus $\overrightarrow{AC} \cdot \overrightarrow{BC} = (-\mathbf{a} + \mathbf{c}) \cdot (\mathbf{a} + \mathbf{c})$

$$= -\mathbf{a} \cdot \mathbf{a} + \mathbf{c} \cdot \mathbf{c}$$

$$= -|\mathbf{a}|^2 + |\mathbf{c}|^2$$

But $|\mathbf{a}| = |\mathbf{c}|$ and therefore $\overrightarrow{AC} \cdot \overrightarrow{BC} = 0$. Hence $AC \perp BC$.

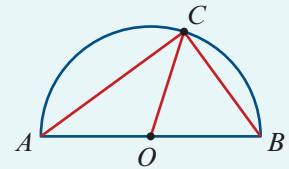



Example 30

Prove that the medians of a triangle are concurrent.

Solution

Consider triangle OAB . Let A' , B' and X be the midpoints of OB , OA and AB respectively.

Let Y be the point of intersection of the medians AA' and BB' .

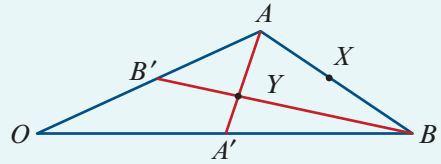

Let $\mathbf{a} = \overrightarrow{OA}$ and $\mathbf{b} = \overrightarrow{OB}$.

We start by showing that $AY : YA' = BY : YB' = 2 : 1$.

We have $\overrightarrow{AY} = \lambda \overrightarrow{AA'}$ and $\overrightarrow{BY} = \mu \overrightarrow{BB'}$, for some $\lambda, \mu \in \mathbb{R}$.

Now $\overrightarrow{AA'} = \overrightarrow{AO} + \frac{1}{2}\overrightarrow{OB}$ and $\overrightarrow{BB'} = \overrightarrow{BO} + \frac{1}{2}\overrightarrow{OA}$

$$= -\mathbf{a} + \frac{1}{2}\mathbf{b} \qquad \qquad = -\mathbf{b} + \frac{1}{2}\mathbf{a}$$

$$\therefore \overrightarrow{AY} = \lambda \left(-\mathbf{a} + \frac{1}{2}\mathbf{b} \right) \qquad \therefore \overrightarrow{BY} = \mu \left(-\mathbf{b} + \frac{1}{2}\mathbf{a} \right)$$

But \overrightarrow{BY} can also be obtained as follows:

$$\begin{aligned} \overrightarrow{BY} &= \overrightarrow{BA} + \overrightarrow{AY} \\ &= \overrightarrow{BO} + \overrightarrow{OA} + \overrightarrow{AY} \\ &= -\mathbf{b} + \mathbf{a} + \lambda \left(-\mathbf{a} + \frac{1}{2}\mathbf{b} \right) \end{aligned}$$

$$\therefore -\mu\mathbf{b} + \frac{\mu}{2}\mathbf{a} = (1 - \lambda)\mathbf{a} + \left(\frac{\lambda}{2} - 1 \right)\mathbf{b}$$

Since \mathbf{a} and \mathbf{b} are independent vectors, we now have

$$\frac{\mu}{2} = 1 - \lambda \quad (1) \qquad \text{and} \qquad -\mu = \frac{\lambda}{2} - 1 \quad (2)$$

Multiply (1) by 2 and add to (2):

$$0 = 2 - 2\lambda + \frac{\lambda}{2} - 1$$

$$1 = \frac{3\lambda}{2}$$

$$\therefore \lambda = \frac{2}{3}$$

Substitute in (1) to find $\mu = \frac{2}{3}$.

We have shown that $AY : YA' = BY : YB' = 2 : 1$.

Now, by symmetry, the point of intersection of the medians AA' and OX must also divide AA' in the ratio $2 : 1$, and therefore must be Y .

Hence the three medians are concurrent at Y .

Exercise 5F

- 1 Prove that the diagonals of a parallelogram bisect each other.
- 2 Prove that if the midpoints of the sides of a rectangle are joined, then a rhombus is formed.
- 3 Prove that if the midpoints of the sides of a square are joined, then another square is formed.
- 4 Prove that the median to the base of an isosceles triangle is perpendicular to the base.
- 5 Prove that if the diagonals of a parallelogram are of equal length, then the parallelogram is a rectangle.
- 6 Prove that the midpoint of the hypotenuse of a right-angled triangle is equidistant from the three vertices of the triangle.
- 7 Prove that the sum of the squares of the lengths of the diagonals of any parallelogram is equal to the sum of the squares of the lengths of the sides.
- 8 Prove that if the midpoints of the sides of a quadrilateral are joined, then a parallelogram is formed.
- 9 $ABCD$ is a parallelogram, M is the midpoint of AB and P is the point of trisection of MD nearer to M . Prove that A , P and C are collinear and that P is a point of trisection of AC .
- 10 $ABCD$ is a parallelogram with $\overrightarrow{AB} = \mathbf{a}$ and $\overrightarrow{AD} = \mathbf{b}$. The point P lies on AD and is such that $AP : PD = 1 : 2$ and the point Q lies on BD and is such that $BQ : QD = 2 : 1$. Show that PQ is parallel to AC .

- 11 AB and CD are diameters of a circle with centre O . Prove that $ACBD$ is a rectangle.

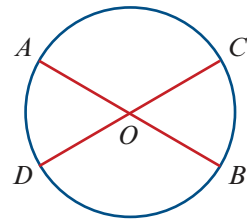

- 12 In triangle AOB , $\mathbf{a} = \overrightarrow{OA}$, $\mathbf{b} = \overrightarrow{OB}$ and M is the midpoint of AB .

a Find:

- i \overrightarrow{AM} in terms of \mathbf{a} and \mathbf{b}
- ii \overrightarrow{OM} in terms of \mathbf{a} and \mathbf{b}

b Find $\overrightarrow{AM} \cdot \overrightarrow{AM} + \overrightarrow{OM} \cdot \overrightarrow{OM}$.

c Hence prove that $OA^2 + OB^2 = 2OM^2 + 2AM^2$.

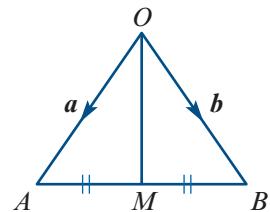

- 13** In the figure, O is the midpoint of AD and B is the midpoint of OC . Let $\mathbf{a} = \overrightarrow{OA}$ and $\mathbf{b} = \overrightarrow{OB}$.

Let P be the point such that $\overrightarrow{OP} = \frac{1}{3}(\mathbf{a} + 4\mathbf{b})$.

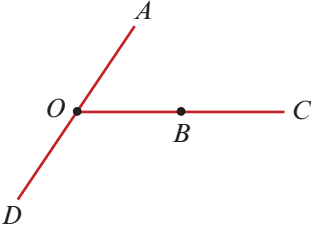
- a** Prove that A , P and C are collinear.
b Prove that D , B and P are collinear.
c Find $DB : BP$.
- 
- 14** In triangle AOB , $\mathbf{a} = \overrightarrow{OA}$ and $\mathbf{b} = \overrightarrow{OB}$. The point P is on AB such that the length of AP is twice the length of BP . The point Q is such that $\overrightarrow{OQ} = 3\overrightarrow{OP}$.
- a** Find each of the following in terms of \mathbf{a} and \mathbf{b} :
- i** \overrightarrow{OP} **ii** \overrightarrow{OQ} **iii** \overrightarrow{AQ}
- b** Hence show that \overrightarrow{AQ} is parallel to \overrightarrow{OB} .
- 15** $ORST$ is a parallelogram, U is the midpoint of RS and V is the midpoint of ST . Relative to the origin O , the position vectors of points R , S , T , U and V are \mathbf{r} , \mathbf{s} , \mathbf{t} , \mathbf{u} and \mathbf{v} respectively.
- a** Express \mathbf{s} in terms of \mathbf{r} and \mathbf{t} .
b Express \mathbf{v} in terms of \mathbf{s} and \mathbf{t} .
c Hence, or otherwise, show that $4(\mathbf{u} + \mathbf{v}) = 3(\mathbf{r} + \mathbf{s} + \mathbf{t})$.

- 16** The points A , B , C , D and E shown in the diagram have position vectors

$$\mathbf{a} = \mathbf{i} + 11\mathbf{j} \quad \mathbf{b} = 2\mathbf{i} + 8\mathbf{j} \quad \mathbf{c} = -\mathbf{i} + 7\mathbf{j}$$

$$\mathbf{d} = -2\mathbf{i} + 8\mathbf{j} \quad \mathbf{e} = -4\mathbf{i} + 6\mathbf{j}$$

respectively. The lines AB and DC intersect at F as shown.

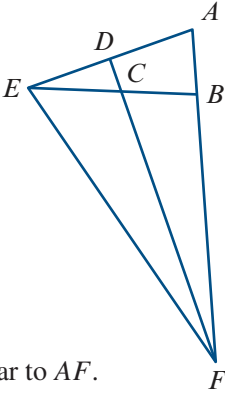
- a** Show that E lies on the lines DA and BC .
b Find \overrightarrow{AB} and \overrightarrow{DC} .
c Find the position vector of the point F .
d Show that FD is perpendicular to EA and that EB is perpendicular to AF .
e Find the position vector of the centre of the circle through E , D , B and F .
- 
- 17** Coplanar points A , B , C , D and E have position vectors \mathbf{a} , \mathbf{b} , \mathbf{c} , \mathbf{d} and \mathbf{e} respectively, relative to an origin O . The point A is the midpoint of OB and the point E divides AC in the ratio $1 : 2$. If $\mathbf{e} = \frac{1}{3}\mathbf{d}$, show that $OCDB$ is a parallelogram.
- 18** The points A and B have position vectors \mathbf{a} and \mathbf{b} respectively, relative to an origin O . The point P divides the line segment OA in the ratio $1 : 3$ and the point R divides the line segment AB in the ratio $1 : 2$. Given that $PRBQ$ is a parallelogram, determine the position of Q .

- 19** $ABCD$ is a parallelogram, AB is extended to E and BA is extended to F such that $BE = AF = BC$. Line segments EC and FD are extended to meet at X .

- a** Prove that the lines EX and FX meet at right angles.
b If $\vec{EX} = \lambda \vec{EC}$, $\vec{FX} = \mu \vec{FD}$ and $|\vec{AB}| = k|\vec{BC}|$, find the values of λ and μ in terms of k .
c Find the values of λ and μ if $ABCD$ is a rhombus.
d If $|\vec{EX}| = |\vec{FX}|$, prove that $ABCD$ is a rectangle.

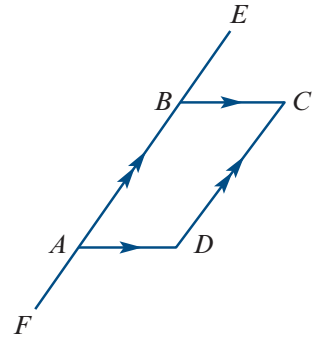

- 20** $OBCDEFGH$ is a parallelepiped. Let $\mathbf{b} = \vec{OB}$, $\mathbf{d} = \vec{OD}$ and $\mathbf{e} = \vec{OE}$.

- a** Express each of the vectors \vec{OG} , \vec{DF} , \vec{BH} and \vec{CE} in terms of \mathbf{b} , \mathbf{d} and \mathbf{e} .
b Find $|\vec{OG}|^2$, $|\vec{DF}|^2$, $|\vec{BH}|^2$ and $|\vec{CE}|^2$ in terms of \mathbf{b} , \mathbf{d} and \mathbf{e} .
c Show that $|\vec{OG}|^2 + |\vec{DF}|^2 + |\vec{BH}|^2 + |\vec{CE}|^2 = 4(|\mathbf{b}|^2 + |\mathbf{d}|^2 + |\mathbf{e}|^2)$.

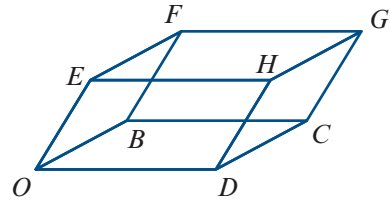

- 21** In the figure, the circle has centre O and radius r . The circle is inscribed in a square $ABCD$, and P is any point on the circle.

- a** Show that $\vec{AP} \cdot \vec{AP} = 3r^2 - 2\vec{OP} \cdot \vec{OA}$.
b Hence find $AP^2 + BP^2 + CP^2 + DP^2$ in terms of r .

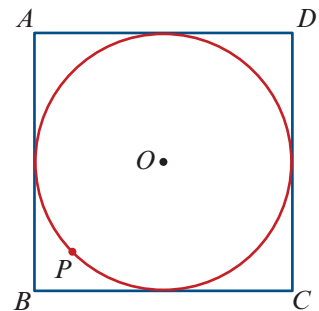

Chapter summary



- A **vector** is a set of equivalent **directed line segments**.
- A directed line segment from a point A to a point B is denoted by \overrightarrow{AB} .
- The **position vector** of a point A is the vector \overrightarrow{OA} , where O is the origin.
- A vector can be written as a column of numbers. The vector $\begin{bmatrix} 2 \\ 3 \end{bmatrix}$ is '2 across and 3 up'.

Basic operations on vectors

■ Addition

- The sum $\mathbf{u} + \mathbf{v}$ is obtained geometrically as shown.
- If $\mathbf{u} = \begin{bmatrix} a \\ b \end{bmatrix}$ and $\mathbf{v} = \begin{bmatrix} c \\ d \end{bmatrix}$, then $\mathbf{u} + \mathbf{v} = \begin{bmatrix} a + c \\ b + d \end{bmatrix}$.

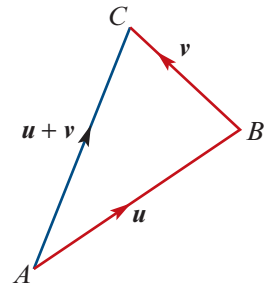

■ Scalar multiplication

- For $k \in \mathbb{R}^+$, the vector $k\mathbf{u}$ has the same direction as \mathbf{u} , but its length is multiplied by a factor of k .
- The vector $-\mathbf{v}$ has the same length as \mathbf{v} , but the opposite direction.
- Two non-zero vectors \mathbf{u} and \mathbf{v} are **parallel** if there exists $k \in \mathbb{R} \setminus \{0\}$ such that $\mathbf{u} = k\mathbf{v}$.

■ Subtraction $\mathbf{u} - \mathbf{v} = \mathbf{u} + (-\mathbf{v})$

Component form

- In two dimensions, each vector \mathbf{u} can be written in the form $\mathbf{u} = x\mathbf{i} + y\mathbf{j}$, where
 - \mathbf{i} is the unit vector in the positive direction of the x -axis
 - \mathbf{j} is the unit vector in the positive direction of the y -axis.
- The **magnitude** of vector $\mathbf{u} = x\mathbf{i} + y\mathbf{j}$ is given by $|\mathbf{u}| = \sqrt{x^2 + y^2}$.

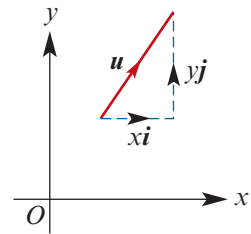

- In three dimensions, each vector \mathbf{u} can be written in the form $\mathbf{u} = x\mathbf{i} + y\mathbf{j} + z\mathbf{k}$, where \mathbf{i} , \mathbf{j} and \mathbf{k} are unit vectors as shown.

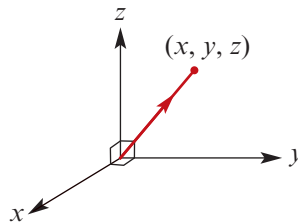

- If $\mathbf{u} = x\mathbf{i} + y\mathbf{j} + z\mathbf{k}$, then $|\mathbf{u}| = \sqrt{x^2 + y^2 + z^2}$.

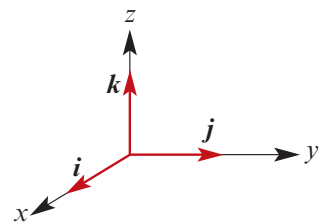

- If the vector $\mathbf{a} = a_1\mathbf{i} + a_2\mathbf{j} + a_3\mathbf{k}$ makes angles α , β and γ with the positive directions of the x -, y - and z -axes respectively, then

$$\cos \alpha = \frac{a_1}{|\mathbf{a}|}, \quad \cos \beta = \frac{a_2}{|\mathbf{a}|} \quad \text{and} \quad \cos \gamma = \frac{a_3}{|\mathbf{a}|}$$

- The **unit vector** in the direction of vector \mathbf{a} is given by

$$\hat{\mathbf{a}} = \frac{1}{|\mathbf{a}|} \mathbf{a}$$

Scalar product and vector projections

- The **scalar product** of vectors $\mathbf{a} = a_1\mathbf{i} + a_2\mathbf{j} + a_3\mathbf{k}$ and $\mathbf{b} = b_1\mathbf{i} + b_2\mathbf{j} + b_3\mathbf{k}$ is given by

$$\mathbf{a} \cdot \mathbf{b} = a_1b_1 + a_2b_2 + a_3b_3$$

- The scalar product is described geometrically by $\mathbf{a} \cdot \mathbf{b} = |\mathbf{a}||\mathbf{b}|\cos\theta$, where θ is the angle between \mathbf{a} and \mathbf{b} .

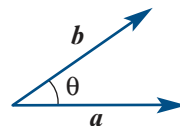

- Therefore $\mathbf{a} \cdot \mathbf{a} = |\mathbf{a}|^2$.

- Two non-zero vectors \mathbf{a} and \mathbf{b} are **perpendicular** if and only if $\mathbf{a} \cdot \mathbf{b} = 0$.

- Resolving a vector \mathbf{a} into rectangular components is expressing the vector \mathbf{a} as a sum of two vectors, one parallel to a given vector \mathbf{b} and the other perpendicular to \mathbf{b} .

- The **vector resolute** of \mathbf{a} in the direction of \mathbf{b} is $\frac{\mathbf{a} \cdot \mathbf{b}}{\mathbf{b} \cdot \mathbf{b}} \mathbf{b}$.

- The **scalar resolute** of \mathbf{a} in the direction of \mathbf{b} is $\frac{\mathbf{a} \cdot \mathbf{b}}{|\mathbf{b}|}$.

Linear dependence and independence

- A set of vectors is said to be **linearly dependent** if at least one of its members can be expressed as a linear combination of other vectors in the set.
- A set of vectors is said to be **linearly independent** if it is not linearly dependent.
- Linear combinations of independent vectors: Let \mathbf{a} and \mathbf{b} be two linearly independent (i.e. not parallel) vectors. Then $m\mathbf{a} + n\mathbf{b} = p\mathbf{a} + q\mathbf{b}$ implies $m = p$ and $n = q$.

Short-answer questions

- $ABCD$ is a parallelogram, where A , B and C have position vectors $\mathbf{i} + 2\mathbf{j} - \mathbf{k}$, $2\mathbf{i} + \mathbf{j} - 2\mathbf{k}$ and $4\mathbf{i} - \mathbf{k}$ respectively. Find:
 - \overrightarrow{AD}
 - the cosine of $\angle BAD$
- Points A , B and C are defined by position vectors $2\mathbf{i} - \mathbf{j} - 4\mathbf{k}$, $-\mathbf{i} + \mathbf{j} + 2\mathbf{k}$ and $\mathbf{i} - 3\mathbf{j} - 2\mathbf{k}$ respectively. Point M is on the line segment AB such that $|\overrightarrow{AM}| = |\overrightarrow{AC}|$.
 - Find:
 - \overrightarrow{AM}
 - the position vector of N , the midpoint of CM
 - Hence show that $\overrightarrow{AN} \perp \overrightarrow{CM}$.
- Let $\mathbf{a} = 4\mathbf{i} + 3\mathbf{j} - \mathbf{k}$, $\mathbf{b} = 2\mathbf{i} - \mathbf{j} + x\mathbf{k}$ and $\mathbf{c} = y\mathbf{i} + z\mathbf{j} - 2\mathbf{k}$. Find:
 - x such that \mathbf{a} and \mathbf{b} are perpendicular to each other
 - y and z such that \mathbf{a} , \mathbf{b} and \mathbf{c} are mutually perpendicular
- Let $\mathbf{a} = \mathbf{i} - 2\mathbf{j} + 2\mathbf{k}$ and let \mathbf{b} be a vector such that the vector resolute of \mathbf{a} in the direction of \mathbf{b} is $\hat{\mathbf{b}}$.
 - Find the cosine of the angle between the directions of \mathbf{a} and \mathbf{b} .
 - Find $|\mathbf{b}|$ if the vector resolute of \mathbf{b} in the direction of \mathbf{a} is $2\hat{\mathbf{a}}$.

- 5** Let $\mathbf{a} = 3\mathbf{i} - 6\mathbf{j} + 4\mathbf{k}$ and $\mathbf{b} = 2\mathbf{i} + \mathbf{j} - 2\mathbf{k}$.
- Find \mathbf{c} , the vector component of \mathbf{a} perpendicular to \mathbf{b} .
 - Find \mathbf{d} , the vector resolute of \mathbf{c} in the direction of \mathbf{a} .
 - Hence show that $|\mathbf{a}||\mathbf{d}| = |\mathbf{c}|^2$.
- 6** Points A and B have position vectors $\mathbf{a} = 2\mathbf{i} + 3\mathbf{j} - 4\mathbf{k}$ and $\mathbf{b} = 2\mathbf{i} - \mathbf{j} + 2\mathbf{k}$. Point C has position vector $\mathbf{c} = 2\mathbf{i} + (1 + 3t)\mathbf{j} + (-1 + 2t)\mathbf{k}$.
- Find in terms of t :
 - \overrightarrow{CA}
 - \overrightarrow{CB}
 - Find the values of t for which $\angle BCA = 90^\circ$.
- 7** $OABC$ is a parallelogram, where A and C have position vectors $\mathbf{a} = 2\mathbf{i} + 2\mathbf{j} - \mathbf{k}$ and $\mathbf{c} = 2\mathbf{i} - 6\mathbf{j} - 3\mathbf{k}$ respectively.
- Find:
 - $|\mathbf{a} - \mathbf{c}|$
 - $|\mathbf{a} + \mathbf{c}|$
 - $(\mathbf{a} - \mathbf{c}) \cdot (\mathbf{a} + \mathbf{c})$
 - Hence find the magnitude of the acute angle between the diagonals of the parallelogram.
- 8** $OABC$ is a trapezium with $\overrightarrow{OC} = 2\overrightarrow{AB}$. If $\overrightarrow{OA} = 2\mathbf{i} - \mathbf{j} - 3\mathbf{k}$ and $\overrightarrow{OC} = 6\mathbf{i} - 3\mathbf{j} + 2\mathbf{k}$, find:
- \overrightarrow{AB}
 - \overrightarrow{BC}
 - the cosine of $\angle BAC$.
- 9** The position vectors of A and B , relative to an origin O , are $6\mathbf{i} + 4\mathbf{j}$ and $3\mathbf{i} + p\mathbf{j}$.
- Express $\overrightarrow{AO} \cdot \overrightarrow{AB}$ in terms of p .
 - Find the value of p for which \overrightarrow{AO} is perpendicular to \overrightarrow{AB} .
 - Find the cosine of $\angle OAB$ when $p = 6$.
- 10** Points A , B and C have position vectors $\mathbf{p} + \mathbf{q}$, $3\mathbf{p} - 2\mathbf{q}$ and $6\mathbf{p} + m\mathbf{q}$ respectively, where \mathbf{p} and \mathbf{q} are non-zero, non-parallel vectors. Find the value of m such that the points A , B and C are collinear.
- 11** If $\mathbf{r} = 3\mathbf{i} + 3\mathbf{j} - 6\mathbf{k}$, $\mathbf{s} = \mathbf{i} - 7\mathbf{j} + 6\mathbf{k}$ and $\mathbf{t} = -2\mathbf{i} - 5\mathbf{j} + 2\mathbf{k}$, find the values of λ and μ such that the vector $\mathbf{r} + \lambda\mathbf{s} + \mu\mathbf{t}$ is parallel to the x -axis.
- 12** Show that the points $A(4, 3, 0)$, $B(5, 2, 3)$, $C(4, -1, 3)$ and $D(2, 1, -3)$ form a trapezium and state the ratio of the parallel sides.
- 13** If $\mathbf{a} = 2\mathbf{i} - \mathbf{j} + 6\mathbf{k}$ and $\mathbf{b} = \mathbf{i} - \mathbf{j} - \mathbf{k}$, show that $\mathbf{a} + \mathbf{b}$ is perpendicular to \mathbf{b} and find the cosine of the angle between the vectors $\mathbf{a} + \mathbf{b}$ and $\mathbf{a} - \mathbf{b}$.
- 14** O , A and B are the points with coordinates $(0, 0)$, $(3, 4)$ and $(4, -6)$ respectively.
- Let C be the point such that $\overrightarrow{OA} = \overrightarrow{OC} + \overrightarrow{OB}$. Find the coordinates of C .
 - Let D be the point $(1, 24)$. If $\overrightarrow{OD} = h\overrightarrow{OA} + k\overrightarrow{OB}$, find the values of h and k .

- 15** Relative to O , the position vectors of A , B and C are \mathbf{a} , \mathbf{b} and \mathbf{c} . Points B and C are the midpoints of AD and OD respectively.

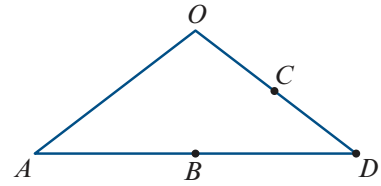

- a** Find \overrightarrow{OD} and \overrightarrow{AD} in terms of \mathbf{a} and \mathbf{c} .
b Find \mathbf{b} in terms of \mathbf{a} and \mathbf{c} .
c Point E on the extension of OA is such that $\overrightarrow{OE} = 4\overrightarrow{AE}$. If $\overrightarrow{CB} = k\overrightarrow{AE}$, find the value of k .

- 16** $\overrightarrow{OP} = \mathbf{p}$ $\overrightarrow{OQ} = \mathbf{q}$
 $\overrightarrow{OR} = \frac{1}{3}\mathbf{p} + k\mathbf{q}$ $\overrightarrow{OS} = h\mathbf{p} + \frac{1}{2}\mathbf{q}$

Given that R is the midpoint of QS , find h and k .

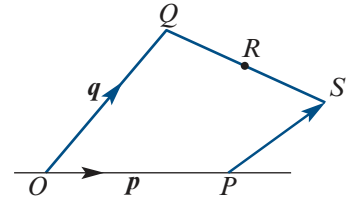

- 17** ABC is a right-angled triangle with the right angle at B . If $\overrightarrow{AC} = 2\mathbf{i} + 4\mathbf{j}$ and \overrightarrow{AB} is parallel to $\mathbf{i} + \mathbf{j}$, find \overrightarrow{AB} .

- 18** In this diagram, $OABC$ is a parallelogram with $\overrightarrow{OA} = 2\overrightarrow{AD}$. Let $\mathbf{a} = \overrightarrow{AD}$ and $\mathbf{c} = \overrightarrow{OC}$.

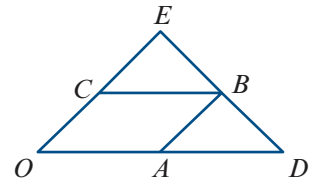

- a** Express \overrightarrow{DB} in terms of \mathbf{a} and \mathbf{c} .
b Use a vector method to prove that $\overrightarrow{OE} = 3\overrightarrow{OC}$.

- 19** For a quadrilateral $OABC$, let D be the point of trisection of OC nearer O and let E be the point of trisection of AB nearer A . Let $\mathbf{a} = \overrightarrow{OA}$, $\mathbf{b} = \overrightarrow{OB}$ and $\mathbf{c} = \overrightarrow{OC}$.

- a** Find:
i \overrightarrow{OD} **ii** \overrightarrow{OE} **iii** \overrightarrow{DE}
b Hence prove that $3\overrightarrow{DE} = 2\overrightarrow{OA} + \overrightarrow{CB}$.

- 20** In triangle OAB , $\mathbf{a} = \overrightarrow{OA}$, $\mathbf{b} = \overrightarrow{OB}$ and T is a point on AB such that $AT = 3TB$.

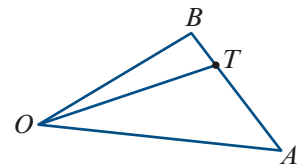

- a** Find \overrightarrow{OT} in terms of \mathbf{a} and \mathbf{b} .
b If M is a point such that $\overrightarrow{OM} = \lambda\overrightarrow{OT}$, where $\lambda > 1$, find:
i \overrightarrow{BM} in terms of \mathbf{a} , \mathbf{b} and λ **ii** λ , if \overrightarrow{BM} is parallel to \overrightarrow{OA} .

- 21** Given that $\mathbf{a} = \mathbf{i} + \mathbf{j} + 3\mathbf{k}$, $\mathbf{b} = \mathbf{i} - 2\mathbf{j} + m\mathbf{k}$ and $\mathbf{c} = -2\mathbf{i} + n\mathbf{j} + 2\mathbf{k}$ are linearly dependent, express m in terms of n .

- 22** Let $\mathbf{a} = 2\mathbf{i} + \mathbf{j} + 2\mathbf{k}$ and $\mathbf{b} = \mathbf{i} + 3\mathbf{k}$.

- a** Find \mathbf{v} , the vector resolute of \mathbf{a} perpendicular to \mathbf{b} .
b Prove that \mathbf{v} , \mathbf{a} and \mathbf{b} are linearly dependent.



Multiple-choice questions



1 If $\vec{OX} = \mathbf{a} + 2\mathbf{b}$ and $\vec{XY} = \mathbf{a} - \mathbf{b}$, then \vec{OY} in terms of \mathbf{a} and \mathbf{b} is equal to

- A** \mathbf{b} **B** $3\mathbf{b}$ **C** $2\mathbf{a} + \mathbf{b}$ **D** $2\mathbf{a} + 3\mathbf{b}$ **E** $3\mathbf{a} + \mathbf{b}$

2 The grid shown is made up of identical parallelograms. Let $\mathbf{a} = \vec{AB}$ and $\mathbf{c} = \vec{CD}$. Then the vector \vec{EF} is equal to

- A** $\mathbf{a} + 3\mathbf{c}$ **B** $-3\mathbf{a} + \mathbf{c}$ **C** $-3\mathbf{a} - \mathbf{c}$
D $3\mathbf{a} - \mathbf{c}$ **E** $3\mathbf{a} + \mathbf{c}$

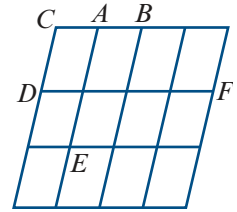

3 $ABCD$ is a parallelogram with $\vec{AB} = \mathbf{u}$ and $\vec{BC} = \mathbf{v}$. If M is the midpoint of AB , then the vector \vec{DM} expressed in terms of \mathbf{u} and \mathbf{v} is equal to

- A** $\frac{1}{2}\mathbf{u} + \mathbf{v}$ **B** $\frac{1}{2}\mathbf{u} - \mathbf{v}$ **C** $\mathbf{u} + \frac{1}{2}\mathbf{v}$ **D** $\mathbf{u} - \frac{1}{2}\mathbf{v}$ **E** $\frac{3}{2}\mathbf{u} - \mathbf{v}$

4 If $A = (3, 6)$ and $B = (11, 1)$, then the vector \vec{AB} in terms of \mathbf{i} and \mathbf{j} is equal to

- A** $3\mathbf{i} + 6\mathbf{j}$ **B** $8\mathbf{i} - 5\mathbf{j}$ **C** $8\mathbf{i} + 5\mathbf{j}$ **D** $14\mathbf{i} + 7\mathbf{j}$ **E** $14\mathbf{i} - 7\mathbf{j}$

5 The angle between the vector $2\mathbf{i} + \mathbf{j} - \sqrt{2}\mathbf{k}$ and $5\mathbf{i} + 8\mathbf{j}$ is approximately

- A** 0.72° **B** 0.77° **C** 43.85° **D** 46.15° **E** 88.34°

6 Let OAB be a triangle such that $\vec{AO} \cdot \vec{AB} = \vec{BO} \cdot \vec{BA}$ and $|\vec{AB}| \neq |\vec{OB}|$. Then triangle OAB must be

- A** scalene **B** equilateral **C** isosceles **D** right-angled **E** obtuse

7 If \mathbf{a} and \mathbf{b} are non-zero, non-parallel vectors such that $x(\mathbf{a} + \mathbf{b}) = 2y\mathbf{a} + (y + 3)\mathbf{b}$, then the values of x and y are

- A** $x = 3, y = 6$ **B** $x = -6, y = -3$ **C** $x = -2, y = -1$
D $x = 2, y = 1$ **E** $x = 6, y = 3$

8 If A and B are points defined by the position vectors $\mathbf{a} = \mathbf{i} + \mathbf{j}$ and $\mathbf{b} = 5\mathbf{i} - 2\mathbf{j} + 2\mathbf{k}$ respectively, then $|\vec{AB}|$ is equal to

- A** 29 **B** $\sqrt{11}$ **C** 11 **D** $\sqrt{21}$ **E** $\sqrt{29}$

9 Let $\mathbf{x} = 3\mathbf{i} - 2\mathbf{j} + 4\mathbf{k}$ and $\mathbf{y} = -5\mathbf{i} + \mathbf{j} + \mathbf{k}$. The scalar resolute of \mathbf{x} in the direction of \mathbf{y} is

- A** $\frac{21}{\sqrt{27}}$ **B** $\frac{-13\sqrt{23}}{23}$ **C** $\frac{-13\sqrt{29}}{29}$ **D** $\frac{-13\sqrt{27}}{27}$ **E** $\frac{-13\sqrt{21}}{21}$

10 Let $ABCD$ be a rectangle such that $|\vec{BC}| = 3|\vec{AB}|$. If $\vec{AB} = \mathbf{a}$, then $|\vec{AC}|$ in terms of $|\mathbf{a}|$ is equal to

- A** $2|\mathbf{a}|$ **B** $\sqrt{10}|\mathbf{a}|$ **C** $4|\mathbf{a}|$ **D** $10|\mathbf{a}|$ **E** $3|\mathbf{a}|$

- 11** Vectors $\mathbf{a} = 2\mathbf{i} - 8\mathbf{j} + 10\mathbf{k}$, $\mathbf{b} = \mathbf{i} - \mathbf{j} + \mathbf{k}$ and $\mathbf{c} = \mathbf{i} + 2\mathbf{j} + a\mathbf{k}$ are linearly dependent. The value of a is
A -2 **B** -4 **C** -3 **D** 2 **E** 9
- 12** If \mathbf{p} , \mathbf{q} and \mathbf{r} are non-zero vectors such that $\mathbf{r} = \frac{1}{4}\mathbf{p} + \frac{3}{4}\mathbf{q}$, then which one of the following statements must be true?
A \mathbf{p} and \mathbf{q} are linearly dependent **B** \mathbf{p} , \mathbf{q} and \mathbf{r} are linearly dependent
C \mathbf{p} and \mathbf{q} are linearly independent **D** \mathbf{p} , \mathbf{q} and \mathbf{r} are parallel
E \mathbf{r} is perpendicular to both \mathbf{p} and \mathbf{q}
- 13** Consider the four vectors $\mathbf{a} = \mathbf{i} + \mathbf{k}$, $\mathbf{b} = \mathbf{i} + 3\mathbf{k}$, $\mathbf{c} = \mathbf{i} + 2\mathbf{k}$ and $\mathbf{d} = 4\mathbf{i} - 2\mathbf{j}$. Which one of the following is a linearly dependent set of vectors?
A $\{\mathbf{a}, \mathbf{b}, \mathbf{d}\}$ **B** $\{\mathbf{a}, \mathbf{c}, \mathbf{d}\}$ **C** $\{\mathbf{b}, \mathbf{c}, \mathbf{d}\}$ **D** $\{\mathbf{a}, \mathbf{b}, \mathbf{c}\}$ **E** $\{\mathbf{a}, \mathbf{b}\}$



Extended-response questions

- 1** A spider builds a web in a garden. Relative to an origin O , the position vectors of the ends A and B of a strand of the web are $\overrightarrow{OA} = 2\mathbf{i} + 3\mathbf{j} + \mathbf{k}$ and $\overrightarrow{OB} = 3\mathbf{i} + 4\mathbf{j} + 2\mathbf{k}$.
- a** **i** Find \overrightarrow{AB} . **ii** Find the length of the strand.
- b** A small insect is at point C , where $\overrightarrow{OC} = 2.5\mathbf{i} + 4\mathbf{j} + 1.5\mathbf{k}$. Unluckily, it flies in a straight line and hits the strand of web between A and B . Let Q be the point at which the insect hits the strand, where $\overrightarrow{AQ} = \lambda\overrightarrow{AB}$.
- i** Find \overrightarrow{CQ} in terms of λ .
ii If the insect hits the strand at right angles, find the value of λ and the vector \overrightarrow{OQ} .
- c** Another strand MN of the web has endpoints M and N with position vectors $\overrightarrow{OM} = 4\mathbf{i} + 2\mathbf{j} - \mathbf{k}$ and $\overrightarrow{ON} = 6\mathbf{i} + 10\mathbf{j} + 9\mathbf{k}$. The spider decides to continue AB to join MN . Find the position vector of the point of contact.
- 2** The position vectors of points A and B are $2\mathbf{i} + 3\mathbf{j} + \mathbf{k}$ and $3\mathbf{i} - 2\mathbf{j} + \mathbf{k}$.
- a** **i** Find $|\overrightarrow{OA}|$ and $|\overrightarrow{OB}|$. **ii** Find \overrightarrow{AB} .
- b** Let X be the midpoint of line segment AB .
i Find \overrightarrow{OX} . **ii** Show that \overrightarrow{OX} is perpendicular to \overrightarrow{AB} .
- c** Find the position vector of a point C such that $OACB$ is a parallelogram.
- d** Show that the diagonal OC is perpendicular to the diagonal AB by considering the scalar product $\overrightarrow{OC} \cdot \overrightarrow{AB}$.
- e** **i** Find a vector of magnitude $\sqrt{195}$ that is perpendicular to both \overrightarrow{OA} and \overrightarrow{OB} .
ii Show that this vector is also perpendicular to \overrightarrow{AB} and \overrightarrow{OC} .
iii Comment on the relationship between the vector found in **e i** and the parallelogram $OACB$.

- 3** Points A , B and C have position vectors

$$\vec{OA} = 5\mathbf{i}, \quad \vec{OB} = \mathbf{i} + 3\mathbf{k}, \quad \text{and} \quad \vec{OC} = \mathbf{i} + 4\mathbf{j}$$

The parallelepiped has OA , OB and OC as three edges and remaining vertices X , Y , Z and D as shown in the diagram.

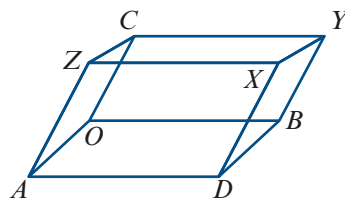

- a** Write down the position vectors of X , Y , Z and D in terms of \mathbf{i} , \mathbf{j} and \mathbf{k} and calculate the lengths of OD and OY .
- b** Calculate the size of angle OZY .
- c** The point P divides CZ in the ratio $\lambda : 1$. That is, $CP : PZ = \lambda : 1$.
- i** Give the position vector of P .
 - ii** Find λ if \vec{OP} is perpendicular to \vec{CZ} .

- 4** ABC is a triangle as shown in the diagram. The points P , Q and R are the midpoints of the sides BC , CA and AB respectively. Point O is the point of intersection of the perpendicular bisectors of CA and AB .

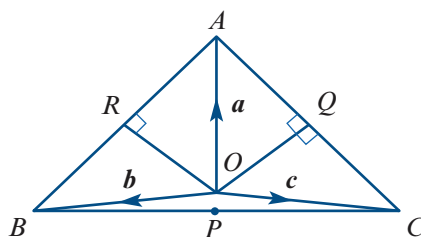

Let $\mathbf{a} = \vec{OA}$, $\mathbf{b} = \vec{OB}$ and $\mathbf{c} = \vec{OC}$.

- a** Express each of the following in terms of \mathbf{a} , \mathbf{b} and \mathbf{c} :
- | | | |
|----------------------|----------------------|-----------------------|
| i \vec{AB} | ii \vec{BC} | iii \vec{CA} |
| iv \vec{OP} | v \vec{OQ} | vi \vec{OR} |
- b** Prove that OP is perpendicular to BC .
- c** Hence prove that the perpendicular bisectors of the sides of a triangle are concurrent.
- d** Prove that $|\mathbf{a}| = |\mathbf{b}| = |\mathbf{c}|$.
- 5** The position vectors of two points B and C , relative to an origin O , are denoted by \mathbf{b} and \mathbf{c} respectively.
- a** In terms of \mathbf{b} and \mathbf{c} , find the position vector of L , the point on BC between B and C such that $BL : LC = 2 : 1$.
- b** Let \mathbf{a} be the position vector of a point A such that O is the midpoint of AL . Prove that $3\mathbf{a} + \mathbf{b} + 2\mathbf{c} = \mathbf{0}$.
- c** Let M be the point on CA between C and A such that $CM : MA = 3 : 2$.
- i** Prove that B , O and M are collinear.
 - ii** Find the ratio $BO : OM$.
- d** Let N be the point on AB such that C , O and N are collinear. Find the ratio $AN : NB$.

- 6** OAB is an isosceles triangle with $OA = OB$.
Let $\mathbf{a} = \overrightarrow{OA}$ and $\mathbf{b} = \overrightarrow{OB}$.

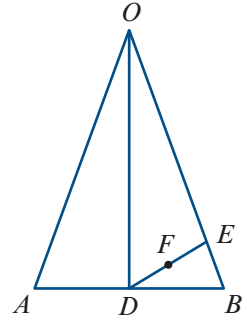

- a** Let D be the midpoint of AB and let E be a point on OB .
Find in terms of \mathbf{a} and \mathbf{b} :
- \overrightarrow{OD}
 - \overrightarrow{DE} if $\overrightarrow{OE} = \lambda \overrightarrow{OB}$
- b** If DE is perpendicular to OB , show that
- $$\lambda = \frac{1}{2} \frac{(\mathbf{a} \cdot \mathbf{b} + \mathbf{b} \cdot \mathbf{b})}{\mathbf{b} \cdot \mathbf{b}}$$
- c** Now assume that DE is perpendicular to OB and that $\lambda = \frac{5}{6}$.
- Show that $\cos \theta = \frac{2}{3}$, where θ is the magnitude of $\angle AOB$.
 - Let F be the midpoint of DE . Show that OF is perpendicular to AE .

- 7** A cuboid is positioned on level ground so that it rests on one of its vertices, O . Vectors \mathbf{i} and \mathbf{j} are on the ground.

$$\overrightarrow{OA} = 3\mathbf{i} - 12\mathbf{j} + 3\mathbf{k}$$

$$\overrightarrow{OB} = 2\mathbf{i} + a\mathbf{j} + 2\mathbf{k}$$

$$\overrightarrow{OC} = x\mathbf{i} + y\mathbf{j} + 2\mathbf{k}$$

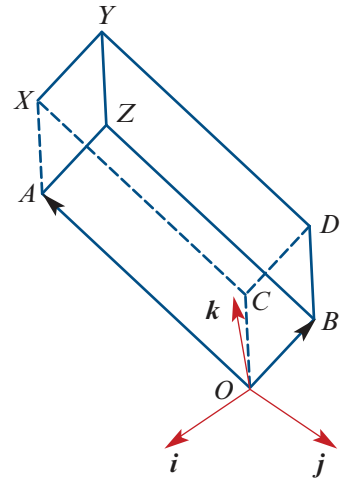

- Find $\overrightarrow{OA} \cdot \overrightarrow{OB}$ in terms of a .
 - Find a .
- Use the fact that \overrightarrow{OA} is perpendicular to \overrightarrow{OC} to write an equation relating x and y .
 - Find the values of x and y .
- Find the position vectors:
 - \overrightarrow{OD}
 - \overrightarrow{OX}
 - \overrightarrow{OY}
- State the height of points X and Y above the ground.

- 8** In the diagram, D is a point on BC with $\frac{BD}{DC} = 3$ and E is a point on AC with $\frac{AE}{EC} = \frac{3}{2}$.
Let P be the point of intersection of AD and BE . Let $\mathbf{a} = \overrightarrow{BA}$ and $\mathbf{c} = \overrightarrow{BC}$.

- a** Find:
- \overrightarrow{BD} in terms of \mathbf{c}
 - \overrightarrow{BE} in terms of \mathbf{a} and \mathbf{c}
 - \overrightarrow{AD} in terms of \mathbf{a} and \mathbf{c}
- b** Let $\overrightarrow{BP} = \mu \overrightarrow{BE}$ and $\overrightarrow{AP} = \lambda \overrightarrow{AD}$.
Find λ and μ .

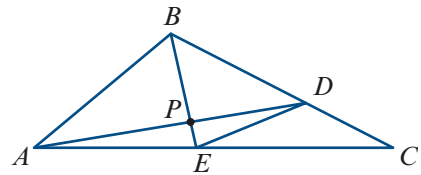

- 9 a** Let $\mathbf{a} = pi + qj$. The vector \mathbf{b} is obtained by rotating \mathbf{a} clockwise through 90° about the origin. The vector \mathbf{c} is obtained by rotating \mathbf{a} anticlockwise through 90° about the origin. Find \mathbf{b} and \mathbf{c} in terms of p, q, \mathbf{i} and \mathbf{j} .

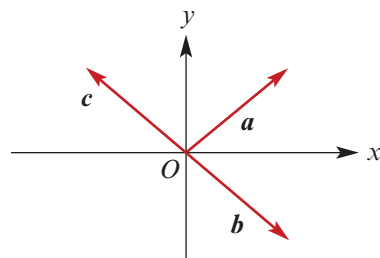

- b** In the diagram, $ABGF$ and $AECD$ are squares with $OB = OC = 1$. Let $\vec{OA} = xi + yj$.
- Find \vec{AB} and \vec{AC} in terms of x, y, \mathbf{i} and \mathbf{j} .
 - Use the results of **a** to find \vec{AE} and \vec{AF} in terms of x, y, \mathbf{i} and \mathbf{j} .
- c**
- Prove that \vec{OA} is perpendicular to \vec{EF} .
 - Prove that $|\vec{EF}| = 2|\vec{OA}|$.

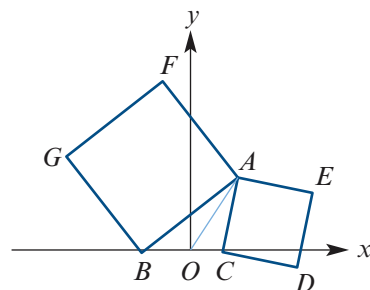

- 10** Triangle ABC is equilateral and $AD = BE = CF$.

- a** Let \mathbf{u}, \mathbf{v} and \mathbf{w} be unit vectors in the directions of \vec{AB}, \vec{BC} and \vec{CA} respectively. Let $\vec{AD} = m\mathbf{u}$ and $\vec{BE} = n\mathbf{v}$.
- Find $\vec{BC}, \vec{BE}, \vec{CA}$ and \vec{CF} .
 - Find $|\vec{AE}|$ and $|\vec{FB}|$ in terms of m and n .

- b** Show that $\vec{AE} \cdot \vec{FB} = \frac{1}{2}(m^2 - mn + n^2)$.

- c** Show that triangle GHK is equilateral. (G is the point of intersection of BF and AE . H is the point of intersection of AE and CD . K is the point of intersection of CD and BF .)

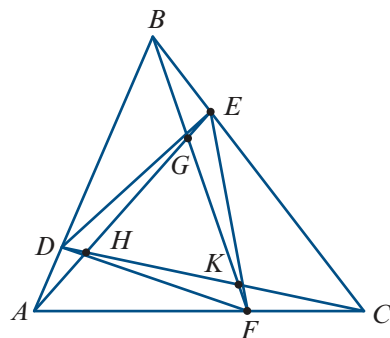

- 11** AOC is a triangle. The medians CF and OE intersect at X .

Let $\mathbf{a} = \vec{OA}$ and $\mathbf{c} = \vec{OC}$.

- a** Find \vec{CF} and \vec{OE} in terms of \mathbf{a} and \mathbf{c} .

- b**
- If \vec{OE} is perpendicular to \vec{AC} , prove that $\triangle OAC$ is isosceles.

- If furthermore \vec{CF} is perpendicular to \vec{OA} , find the magnitude of angle AOC , and hence prove that $\triangle AOC$ is equilateral.

- c** Let H and K be the midpoints of OE and CF respectively.

- Show that $\vec{HK} = \lambda\mathbf{c}$ and $\vec{FE} = \mu\mathbf{c}$, for some $\lambda, \mu \in \mathbb{R} \setminus \{0\}$.

- Give reasons why $\triangle HXK$ is similar to $\triangle EXF$. (Vector method not required.)

- Hence prove that $OX : XE = 2 : 1$.

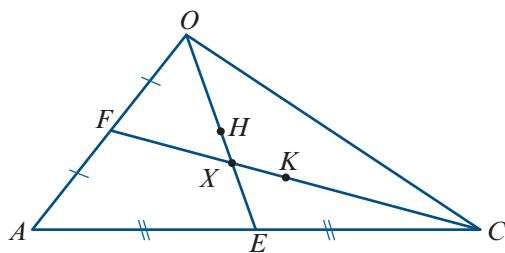

12 $VABCD$ is a square-based pyramid:

- The origin O is the centre of the base.
- The unit vectors \mathbf{i} , \mathbf{j} and \mathbf{k} are in the directions of \overrightarrow{AB} , \overrightarrow{BC} and \overrightarrow{OV} respectively.
- $AB = BC = CD = DA = 4$ cm
- $OV = 2h$ cm, where h is a positive real number.
- P , Q , M and N are the midpoints of AB , BC , VC and VA respectively.

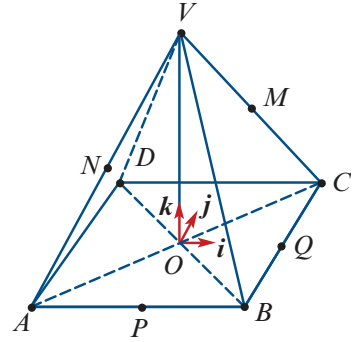

- a Find the position vectors of A , B , C and D relative to O .
- b Find vectors \overrightarrow{PM} and \overrightarrow{QN} in terms of h .
- c Find the position vector \overrightarrow{OX} , where X is the point of intersection of QN and PM .
- d If OX is perpendicular to VB :
 - i find the value of h
 - ii find the acute angle between PM and QN , correct to the nearest degree.
- e i Prove that $NMQP$ is a rectangle.
 - ii Find h if $NMQP$ is a square.

13 $OACB$ is a square with $\overrightarrow{OA} = a\mathbf{j}$ and $\overrightarrow{OB} = a\mathbf{i}$.
Point M is the midpoint of OA .

- a Find in terms of a :
 - i \overrightarrow{OM}
 - ii \overrightarrow{MC}
- b P is a point on MC such that $\overrightarrow{MP} = \lambda\overrightarrow{MC}$.
Find \overrightarrow{MP} , \overrightarrow{BP} and \overrightarrow{OP} in terms of λ and a .
- c If BP is perpendicular to MC :
 - i find the values of λ , $|\overrightarrow{BP}|$, $|\overrightarrow{OP}|$ and $|\overrightarrow{OB}|$
 - ii evaluate $\cos \theta$, where $\theta = \angle PBO$.
- d If $|\overrightarrow{OP}| = |\overrightarrow{OB}|$, find the possible values of λ and illustrate these two cases carefully.
- e In the diagram:
 - $\overrightarrow{OA} = a\mathbf{j}$ and $\overrightarrow{OB} = a\mathbf{i}$
 - M is the midpoint of OA
 - BP is perpendicular to MC
 - $\overrightarrow{PX} = a\mathbf{k}$
 - Y is a point on XC such that PY is perpendicular to XC .

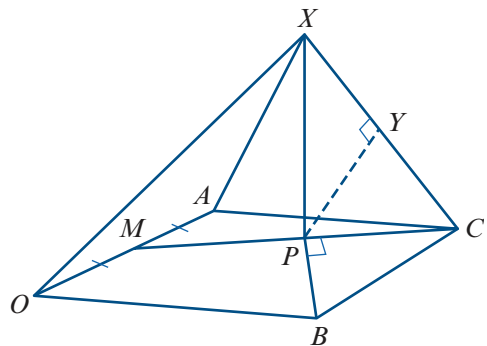
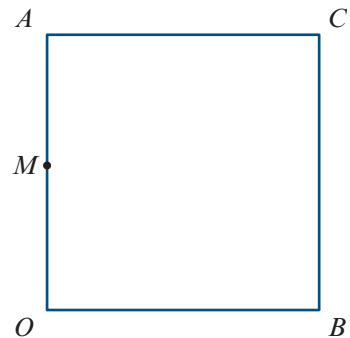

Find \overrightarrow{OY} .



6

Vector equations of lines and planes

Objectives

- ▶ To find a vector equation of a **line** determined by:
 - ▶ a point on the line and a direction vector
 - ▶ two points.
 - ▶ To find a vector equation of the **line segment** between two given points.
 - ▶ To compute the **vector product** of two vectors, and to use the vector product to find a **normal vector** for a plane.
 - ▶ To find a vector equation and Cartesian equation of a **plane** determined by:
 - ▶ a point on the plane and a normal vector
 - ▶ three points.
 - ▶ To determine whether two lines are skew, are parallel or intersect.
 - ▶ To determine whether a line and a plane are parallel or intersect.
 - ▶ To determine whether two planes are parallel or intersect.
 - ▶ To find the **distance** between:
 - ▶ a point and a line
 - ▶ a point and a plane
 - ▶ two parallel planes
 - ▶ two skew lines.
 - ▶ To compute the **angle** between two vectors, lines or planes.
 - ▶ To find and use vector and Cartesian equations of **spheres**.
-

In this chapter, we continue our study of vectors. We use them to investigate the geometric properties of lines and planes in three dimensions.

We know that a line in two-dimensional space can be described very simply by a Cartesian equation of the form $ax + by = c$. We will see that, in three-dimensional space, it is not possible to describe a line via a single Cartesian equation. It is simpler to describe lines in three dimensions using vector equations.

We will study vector equations more generally in Chapter 16.

6A Vector equations of lines

Vector equation of a line given by a point and a direction

A line ℓ in two- or three-dimensional space may be described using two vectors:

- the position vector \mathbf{a} of a point A on the line
- a vector \mathbf{d} parallel to the line.

We can describe the line as

$$\ell = \{ P : \overrightarrow{OP} = \mathbf{a} + t\mathbf{d} \text{ for some } t \in \mathbb{R} \}$$

Usually we omit the set notation. We write $\mathbf{r}(t)$ for the position vector of a point P on the line, and therefore

$$\mathbf{r}(t) = \mathbf{a} + t\mathbf{d}, \quad t \in \mathbb{R}$$

This is a **vector equation** of the line. The variable t is called a **parameter**.

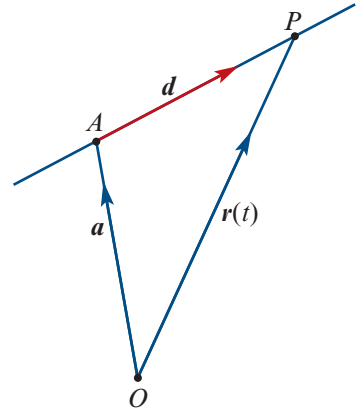

Vector equation of a line given by two points

If the position vectors $\mathbf{a} = \overrightarrow{OA}$ and $\mathbf{b} = \overrightarrow{OB}$ of two points on a line are known, then the line may be described by the vector equation

$$\begin{aligned} \mathbf{r}(t) &= \overrightarrow{OA} + t\overrightarrow{AB} \\ &= \mathbf{a} + t(\mathbf{b} - \mathbf{a}), \quad t \in \mathbb{R} \end{aligned}$$

Note: There is no unique vector equation of a given line. Any point A on the line can be chosen as the ‘starting point’.

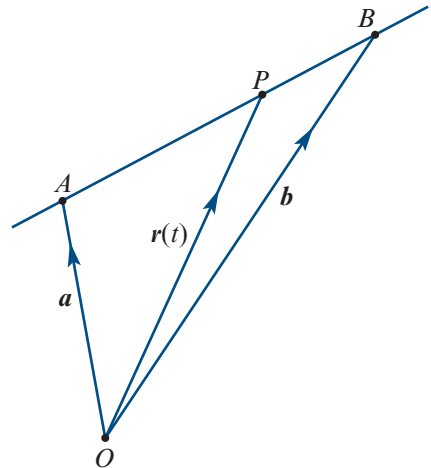

Example 1

Verify that the point $P(-7, 4, -14)$ lies on the line represented by the vector equation

$$\mathbf{r} = 5\mathbf{i} - 2\mathbf{j} + 4\mathbf{k} + t(2\mathbf{i} - \mathbf{j} + 3\mathbf{k}), \quad t \in \mathbb{R}$$

Solution

The point $P(-7, 4, -14)$ has position vector $-7\mathbf{i} + 4\mathbf{j} - 14\mathbf{k}$.

By equating coefficients of \mathbf{i} , \mathbf{j} and \mathbf{k} , we can see that the point P lies on the line if there exists $t \in \mathbb{R}$ such that

$$5 + 2t = -7$$

$$-2 - t = 4$$

$$4 + 3t = -14$$

A solution for each of these equations is $t = -6$. Hence P lies on the line.

Example 2

Find a vector equation of the line AB , where the points A and B have position vectors

$$\vec{OA} = \mathbf{i} + \mathbf{j} - 2\mathbf{k} \quad \text{and} \quad \vec{OB} = 2\mathbf{i} - \mathbf{j} - \mathbf{k}$$

Solution

$$\begin{aligned}\vec{AB} &= \vec{AO} + \vec{OB} \\ &= -(\mathbf{i} + \mathbf{j} - 2\mathbf{k}) + 2\mathbf{i} - \mathbf{j} - \mathbf{k} \\ &= \mathbf{i} - 2\mathbf{j} + \mathbf{k}\end{aligned}$$

Therefore a vector equation of the line is

$$\begin{aligned}\mathbf{r} &= \vec{OA} + t\vec{AB} \\ &= \mathbf{i} + \mathbf{j} - 2\mathbf{k} + t(\mathbf{i} - 2\mathbf{j} + \mathbf{k}), \quad t \in \mathbb{R}\end{aligned}$$

Note: This can also be written as $\mathbf{r} = (1 + t)\mathbf{i} + (1 - 2t)\mathbf{j} + (-2 + t)\mathbf{k}$, $t \in \mathbb{R}$.

**Example 3**

Find a vector equation for each of the following lines:

- a** the line passing through the points $A(1, 2)$ and $B(0, -3)$
- b** the line through $A(1, 2)$ that is parallel to $2\mathbf{i} + 3\mathbf{j}$
- c** the line passing through the points $A(3, -5, 4)$ and $B(-4, 3, 10)$

Solution

$$\begin{aligned}\mathbf{a} \quad \vec{AB} &= \vec{AO} + \vec{OB} \\ &= -(\mathbf{i} + 2\mathbf{j}) - 3\mathbf{j} \\ &= -\mathbf{i} - 5\mathbf{j}\end{aligned}$$

Therefore a vector equation of the line is

$$\begin{aligned}\mathbf{r} &= \vec{OA} + t\vec{AB} \\ &= \mathbf{i} + 2\mathbf{j} + t(-\mathbf{i} - 5\mathbf{j}), \quad t \in \mathbb{R}\end{aligned}$$

Note: This is equivalent to the equation $\mathbf{r} = \mathbf{i} + 2\mathbf{j} + t(\mathbf{i} + 5\mathbf{j})$, $t \in \mathbb{R}$.

b A vector equation of the line is

$$\mathbf{r} = \mathbf{i} + 2\mathbf{j} + t(2\mathbf{i} + 3\mathbf{j}), \quad t \in \mathbb{R}$$

$$\begin{aligned}\mathbf{c} \quad \vec{AB} &= \vec{AO} + \vec{OB} \\ &= -(3\mathbf{i} - 5\mathbf{j} + 4\mathbf{k}) - 4\mathbf{i} + 3\mathbf{j} + 10\mathbf{k} \\ &= -7\mathbf{i} + 8\mathbf{j} + 6\mathbf{k}\end{aligned}$$

Therefore a vector equation of the line is

$$\begin{aligned}\mathbf{r} &= \vec{OA} + t\vec{AB} \\ &= 3\mathbf{i} - 5\mathbf{j} + 4\mathbf{k} + t(-7\mathbf{i} + 8\mathbf{j} + 6\mathbf{k}), \quad t \in \mathbb{R}\end{aligned}$$

► Cartesian equation of a line in two dimensions

From a vector equation to the Cartesian equation

- For example, start with the vector equation

$$\mathbf{r} = \mathbf{i} + 5\mathbf{j} + t(\mathbf{i} + 2\mathbf{j}), \quad t \in \mathbb{R}$$

- Rearrange this equation as

$$\mathbf{r} = (1 + t)\mathbf{i} + (5 + 2t)\mathbf{j}$$

Let $P(x, y)$ be the point on the line with position vector \mathbf{r} , so that $\mathbf{r} = x\mathbf{i} + y\mathbf{j}$. Then, by equating coefficients of \mathbf{i} and \mathbf{j} , we have

$$x = 1 + t \quad \text{and} \quad y = 5 + 2t$$

These are parametric equations for the line.

- Now eliminate t to find y in terms of x . We have $t = x - 1$, so $y = 5 + 2(x - 1) = 2x + 3$. The Cartesian equation of the line is $y = 2x + 3$.

From the Cartesian equation to a vector equation

For example, start with the Cartesian equation $y = 2x + 3$.

A point on the line is $(0, 3)$, with position vector $3\mathbf{j}$. A vector parallel to the line is $\mathbf{i} + 2\mathbf{j}$ (gradient 2). Therefore a vector equation of the line is

$$\mathbf{r} = 3\mathbf{j} + t(\mathbf{i} + 2\mathbf{j}), \quad t \in \mathbb{R}$$

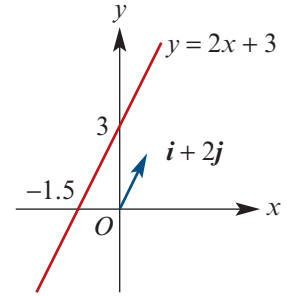

► Cartesian form for a line in three dimensions

From a vector equation to Cartesian form

- For example, the line through the point $(5, -2, 4)$ that is parallel to the vector $2\mathbf{i} - \mathbf{j} + 3\mathbf{k}$ can be described by the vector equation

$$\mathbf{r} = 5\mathbf{i} - 2\mathbf{j} + 4\mathbf{k} + t(2\mathbf{i} - \mathbf{j} + 3\mathbf{k}), \quad t \in \mathbb{R}$$

- Let $P(x, y, z)$ be the point on the line with position vector \mathbf{r} . Then we can write the vector equation as

$$x\mathbf{i} + y\mathbf{j} + z\mathbf{k} = (5 + 2t)\mathbf{i} + (-2 - t)\mathbf{j} + (4 + 3t)\mathbf{k}$$

The corresponding parametric equations are

$$x = 5 + 2t, \quad y = -2 - t \quad \text{and} \quad z = 4 + 3t$$

- Solving each of these equations for t , we have

$$\frac{x - 5}{2} = \frac{y + 2}{-1} = \frac{z - 4}{3} = t$$

This is in **Cartesian form**. You cannot describe a line in three dimensions using a single Cartesian equation.

From Cartesian form to a vector equation To convert from Cartesian form to a vector equation, we can perform these steps in the reverse order.

We have seen that a straight line can be described by a vector equation, by parametric equations or in Cartesian form.

Lines in three dimensions

A line in three-dimensional space can be described in the following three ways, where $\mathbf{a} = a_1\mathbf{i} + a_2\mathbf{j} + a_3\mathbf{k}$ is the position vector of a point A on the line, and $\mathbf{d} = d_1\mathbf{i} + d_2\mathbf{j} + d_3\mathbf{k}$ is a vector parallel to the line.

Vector equation	Parametric equations	Cartesian form
$\mathbf{r} = \mathbf{a} + t\mathbf{d}, \quad t \in \mathbb{R}$	$x = a_1 + d_1t$ $y = a_2 + d_2t$ $z = a_3 + d_3t$	$\frac{x - a_1}{d_1} = \frac{y - a_2}{d_2} = \frac{z - a_3}{d_3}$

► Parallel and perpendicular lines

For two lines $\ell_1: \mathbf{r}_1 = \mathbf{a}_1 + t\mathbf{d}_1, t \in \mathbb{R}$, and $\ell_2: \mathbf{r}_2 = \mathbf{a}_2 + s\mathbf{d}_2, s \in \mathbb{R}$:

- The lines ℓ_1 and ℓ_2 are parallel if and only if \mathbf{d}_1 is parallel to \mathbf{d}_2 .
- The lines ℓ_1 and ℓ_2 are perpendicular if and only if $\mathbf{d}_1 \cdot \mathbf{d}_2 = 0$.

Example 4

Let ℓ be the line with vector equation

$$\mathbf{r} = \mathbf{i} + 2\mathbf{j} + 3\mathbf{k} + t(-\mathbf{i} - 3\mathbf{j}), \quad t \in \mathbb{R}$$

- a Find a vector equation of the line through $A(1, 3, 2)$ that is parallel to the line ℓ .
- b Find a vector equation of the line through $A(1, 3, 2)$ that is perpendicular to the line ℓ and parallel to the x - y plane.

Solution

- a The position vector of A is $\mathbf{i} + 3\mathbf{j} + 2\mathbf{k}$, and a vector parallel to ℓ is $-\mathbf{i} - 3\mathbf{j}$.

Therefore a vector equation of the line through A parallel to ℓ is

$$\mathbf{r} = \mathbf{i} + 3\mathbf{j} + 2\mathbf{k} + s(-\mathbf{i} - 3\mathbf{j}), \quad s \in \mathbb{R}$$

- b If a vector is parallel to the x - y plane, then its \mathbf{k} -component is zero. So we want to find a vector $\mathbf{d} = d_1\mathbf{i} + d_2\mathbf{j}$ that is perpendicular to $-\mathbf{i} - 3\mathbf{j}$.

Therefore we require

$$(d_1\mathbf{i} + d_2\mathbf{j}) \cdot (-\mathbf{i} - 3\mathbf{j}) = 0$$

i.e.
$$-d_1 - 3d_2 = 0$$

We see that we can choose $d_1 = 3$ and $d_2 = -1$. So $\mathbf{d} = 3\mathbf{i} - \mathbf{j}$.

Hence a vector equation of the required line is

$$\mathbf{r} = \mathbf{i} + 3\mathbf{j} + 2\mathbf{k} + s(3\mathbf{i} - \mathbf{j}), \quad s \in \mathbb{R}$$

► Distance between a point and a line

We can use the scalar product to find the distance from a point to a line.

Example 5

Find the distance to the line $\mathbf{r}(t) = (1-t)\mathbf{i} + (2-3t)\mathbf{j} + 2\mathbf{k}$, $t \in \mathbb{R}$, from:

- a** the origin **b** the point $A(1, 3, 2)$.

Solution

The equation of the line can be written as

$$\mathbf{r}(t) = \mathbf{i} + 2\mathbf{j} + 2\mathbf{k} + t(-\mathbf{i} - 3\mathbf{j}), \quad t \in \mathbb{R}$$

So the vector $\mathbf{d} = -\mathbf{i} - 3\mathbf{j}$ is parallel to the line.

- a** The required distance is $|\overrightarrow{OP'}|$, where P' is the point on the line such that OP' is perpendicular to the line.

For a point P on the line with $\overrightarrow{OP} = \mathbf{r}(t)$, we have

$$\begin{aligned} \overrightarrow{OP} \cdot \mathbf{d} &= ((1-t)\mathbf{i} + (2-3t)\mathbf{j} + 2\mathbf{k}) \cdot (-\mathbf{i} - 3\mathbf{j}) \\ &= -(1-t) - 3(2-3t) \\ &= 10t - 7 \end{aligned}$$

If OP' is perpendicular to the line, then

$$\overrightarrow{OP'} \cdot \mathbf{d} = 0 \Rightarrow 10t - 7 = 0 \Rightarrow t = \frac{7}{10}$$

Therefore $\overrightarrow{OP'} = \frac{3}{10}\mathbf{i} - \frac{1}{10}\mathbf{j} + 2\mathbf{k}$.

The distance from the origin to the line is $|\overrightarrow{OP'}| = \frac{\sqrt{410}}{10}$.

- b** The required distance is $|\overrightarrow{AP'}|$, where P' is the point on the line such that AP' is perpendicular to the line.

For a point P on the line with $\overrightarrow{OP} = \mathbf{r}(t)$, we have

$$\begin{aligned} \overrightarrow{AP} &= \overrightarrow{AO} + \overrightarrow{OP} \\ &= -(\mathbf{i} + 3\mathbf{j} + 2\mathbf{k}) + (1-t)\mathbf{i} + (2-3t)\mathbf{j} + 2\mathbf{k} \\ &= -t\mathbf{i} + (-1-3t)\mathbf{j} \end{aligned}$$

$$\begin{aligned} \therefore \overrightarrow{AP} \cdot \mathbf{d} &= (-t\mathbf{i} + (-1-3t)\mathbf{j}) \cdot (-\mathbf{i} - 3\mathbf{j}) \\ &= t - 3(-1-3t) \\ &= 10t + 3 \end{aligned}$$

If $\overrightarrow{AP'} \cdot \mathbf{d} = 0$, then $t = -\frac{3}{10}$ and so $\overrightarrow{AP'} = \frac{3}{10}\mathbf{i} - \frac{1}{10}\mathbf{j}$.

The distance from the point A to the line is $|\overrightarrow{AP'}| = \frac{\sqrt{10}}{10}$.

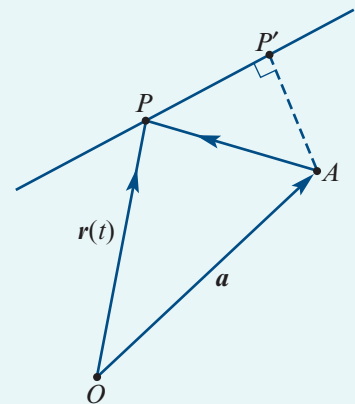
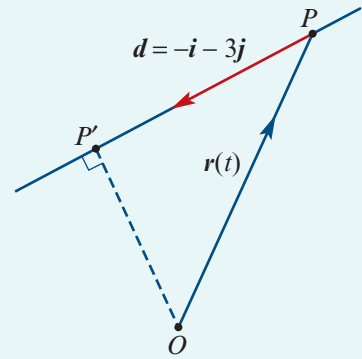

► Describing line segments

We can use a vector equation to describe a line segment by restricting the values of the parameter.



Example 6

Points A and B have position vectors $\mathbf{a} = \mathbf{i} - 4\mathbf{j}$ and $\mathbf{b} = 2\mathbf{i} - 3\mathbf{k}$ respectively.

- Show that the vector equation $\mathbf{r} = \mathbf{i} - 4\mathbf{j} + t(\mathbf{i} + 4\mathbf{j} - 3\mathbf{k})$, $t \in \mathbb{R}$, represents the line through A and B .
- Find the set of values of t which, together with this vector equation, describes the line segment AB .
- Find the set of values of t which, together with this vector equation, describes the line segment AC , where $C(4, 8, -9)$ is a point on the line AB .

Solution

a $\overrightarrow{AB} = \mathbf{b} - \mathbf{a} = \mathbf{i} + 4\mathbf{j} - 3\mathbf{k}$

An equation of the line AB is $\mathbf{r} = \mathbf{i} - 4\mathbf{j} + t(\mathbf{i} + 4\mathbf{j} - 3\mathbf{k})$, $t \in \mathbb{R}$.

b When $t = 0$, $\mathbf{r} = \mathbf{i} - 4\mathbf{j} = \mathbf{a}$.

To find the value of t which gives \mathbf{b} , consider

$$\mathbf{i} - 4\mathbf{j} + t(\mathbf{i} + 4\mathbf{j} - 3\mathbf{k}) = 2\mathbf{i} - 3\mathbf{k}$$

$$(1 + t)\mathbf{i} + 4(t - 1)\mathbf{j} - 3t\mathbf{k} = 2\mathbf{i} - 3\mathbf{k}$$

Therefore $t = 1$.

So the line segment AB is described by $\mathbf{r} = \mathbf{i} - 4\mathbf{j} + t(\mathbf{i} + 4\mathbf{j} - 3\mathbf{k})$, $t \in [0, 1]$.

c To find the value of t which gives \overrightarrow{OC} , consider

$$\mathbf{i} - 4\mathbf{j} + t(\mathbf{i} + 4\mathbf{j} - 3\mathbf{k}) = 4\mathbf{i} + 8\mathbf{j} - 9\mathbf{k}$$

$$(1 + t)\mathbf{i} + 4(t - 1)\mathbf{j} - 3t\mathbf{k} = 4\mathbf{i} + 8\mathbf{j} - 9\mathbf{k}$$

Therefore $t = 3$.

So the line segment AC is described by $\mathbf{r} = \mathbf{i} - 4\mathbf{j} + t(\mathbf{i} + 4\mathbf{j} - 3\mathbf{k})$, $t \in [0, 3]$.

Exercise 6A

Example 1

1 For each of the following, determine whether the point lies on the line:

a $(4, 2, 1)$, $\mathbf{r} = \mathbf{i} + 3\mathbf{j} - \mathbf{k} + t(-3\mathbf{i} + \mathbf{j} - 2\mathbf{k})$, $t \in \mathbb{R}$

b $(3, -3, -4)$, $\mathbf{r} = 6\mathbf{i} + 3\mathbf{j} - \mathbf{k} + t(\mathbf{i} + 2\mathbf{j} + \mathbf{k})$, $t \in \mathbb{R}$

c $(3, -1, -1)$, $\mathbf{r} = -\mathbf{i} + 2\mathbf{j} - 3\mathbf{k} + t(-\mathbf{i} + \mathbf{j} - 2\mathbf{k})$, $t \in \mathbb{R}$

Example 2

2 For each of the following, find a vector equation of the line through the points A and B :

a $\overrightarrow{OA} = \mathbf{i} + \mathbf{j}$, $\overrightarrow{OB} = \mathbf{i} + 3\mathbf{j}$ **b** $\overrightarrow{OA} = \mathbf{i} - 3\mathbf{k}$, $\overrightarrow{OB} = 2\mathbf{i} + \mathbf{j} - \mathbf{k}$

c $\overrightarrow{OA} = 2\mathbf{i} - \mathbf{j} + 2\mathbf{k}$, $\overrightarrow{OB} = \mathbf{i} + \mathbf{j} + \mathbf{k}$ **d** $\overrightarrow{OA} = 2\mathbf{i} - 2\mathbf{j} + \mathbf{k}$, $\overrightarrow{OB} = -2\mathbf{i} + \mathbf{j} + \mathbf{k}$

Example 3 3 For each of the following, find a vector equation of the line that passes through the points A and B :

a $A(3, 1), B(-2, 2)$

b $A(-1, 5), B(2, -1)$

c $A(1, 2, 3), B(2, 0, -1)$

d $A(1, -4, 0), B(2, 3, 1)$

Example 4 4 Find a vector equation of the line through the point $A(2, 1, 0)$ that is:

a parallel to the line $\mathbf{r} = \mathbf{i} + 3\mathbf{j} - \mathbf{k} + t(-3\mathbf{i} + \mathbf{j}), t \in \mathbb{R}$

b perpendicular to the line $\mathbf{r} = \mathbf{i} + 3\mathbf{j} - \mathbf{k} + t(-3\mathbf{i} + \mathbf{j}), t \in \mathbb{R}$, and parallel to the x - y plane.

5 Find a vector equation of the line through the origin that is:

a parallel to the vector $\mathbf{a} = 2\mathbf{j} - \mathbf{k}$

b perpendicular to the line $\mathbf{r} = 2\mathbf{i} + \mathbf{j} + t(2\mathbf{j} - \mathbf{k}), t \in \mathbb{R}$, and in the y - z plane.

6 **a** Find a vector equation of the line AB , where points A and B are defined by the position vectors $\mathbf{a} = 2\mathbf{i} + \mathbf{j}$ and $\mathbf{b} = -\mathbf{i} + 3\mathbf{j}$ respectively.

b Determine which of the following points are on this line:

i $(5, 0)$ **ii** $(0, 7)$ **iii** $(8, -3)$

7 The line ℓ is given by the vector equation

$$\mathbf{r} = \mathbf{i} - 2\mathbf{j} - \mathbf{k} + t(3\mathbf{i} + \mathbf{j} - \mathbf{k}), t \in \mathbb{R}$$

a Find a vector equation of the line which passes through the point $(0, 1, 1)$ and is parallel to the line ℓ .

b Verify that the two equations do not represent the same line ℓ .

c The point $(2, m, n)$ lies on the line ℓ . Find the values of m and n .

8 **a** Let $\mathbf{v} = 3\mathbf{i} - 4\mathbf{j}$. Find a vector that is perpendicular to the vector \mathbf{v} and has the same magnitude as \mathbf{v} .

b Points A and B are given by the position vectors $\mathbf{a} = 2\mathbf{i} - 3\mathbf{j}$ and $\mathbf{b} = -\mathbf{i} + \mathbf{j}$ respectively. Find a vector equation of the line which passes through B and is perpendicular to \overrightarrow{BA} .

c Find the x - and y -axis intercepts of this line.

9 Find parametric equations and Cartesian equations for each line:

a $\mathbf{r} = 2\mathbf{i} + 5\mathbf{j} + 4\mathbf{k} + t(-3\mathbf{i} + \mathbf{j} - 2\mathbf{k}), t \in \mathbb{R}$

b $\mathbf{r} = 2\mathbf{j} - \mathbf{k} + t(2\mathbf{i} + \mathbf{j} + 4\mathbf{k}), t \in \mathbb{R}$

Example 5 10 For each of the following, find the distance from the point to the line:

a $(0, 0, 0), \mathbf{r} = 4\mathbf{i} + \mathbf{j} - 3\mathbf{k} + t(-3\mathbf{i} + 2\mathbf{j} + 5\mathbf{k}), t \in \mathbb{R}$

b $(1, 10, -2), \mathbf{r} = 4\mathbf{i} + \mathbf{j} - 3\mathbf{k} + t(-3\mathbf{i} + 2\mathbf{j} + 5\mathbf{k}), t \in \mathbb{R}$

Example 6 **11** Points A , B and C are defined by the position vectors $\mathbf{a} = \mathbf{i} - 4\mathbf{j} + \mathbf{k}$, $\mathbf{b} = 3\mathbf{i} - \mathbf{k}$ and $\mathbf{c} = -2\mathbf{i} - 10\mathbf{j} + 4\mathbf{k}$ respectively.

- a** Show that the vector equation $\mathbf{r} = \mathbf{i} - 4\mathbf{j} + \mathbf{k} + t(\mathbf{i} + 2\mathbf{j} - \mathbf{k})$, $t \in \mathbb{R}$, represents the line through the points A and B .
- b** Show that the point C is also on this line.
- c** Find the set of values of t which, together with the vector equation, describes the line segment BC .
- 12** Find the coordinates of the point where the line through $A(3, 4, 1)$ and $B(5, 1, 6)$ crosses the x - y plane.
- 13** The line ℓ passes through the points $A(-1, -3, -3)$ and $B(5, 0, 6)$. Find a vector equation of the line ℓ , and find the distance from the origin to the line.
- 14** Find the distance from the point $A(1, 2, 3)$ to the line represented by the vector equation $\mathbf{r} = 3\mathbf{i} + 4\mathbf{j} - 2\mathbf{k} + t(\mathbf{i} - 2\mathbf{j} + 2\mathbf{k})$, $t \in \mathbb{R}$.
- 15** Find the distance from the point $A(1, 1, 4)$ to the line represented by the vector equation $\mathbf{r} = \mathbf{i} - 2\mathbf{j} + \mathbf{k} + t(-2\mathbf{i} + \mathbf{j} + 2\mathbf{k})$, $t \in \mathbb{R}$.
- 16** Find the coordinates of the nearest point to $(2, 1, 3)$ on the line given by the equation $\mathbf{r} = \mathbf{i} + 2\mathbf{j} + t(\mathbf{i} - \mathbf{j} + 2\mathbf{k})$, $t \in \mathbb{R}$.
- 17** Find a vector equation to represent the line through the point $(-2, 2, 1)$ that is parallel to the x -axis.
- 18** Find the distance from the origin to the line that passes through the point $(3, 1, 5)$ and is parallel to the vector $2\mathbf{i} - \mathbf{j} + \mathbf{k}$.
- 19** Give the coordinates of the endpoints of the line segment described by
- $$\mathbf{r} = \mathbf{i} - 2\mathbf{j} + \mathbf{k} + t(-2\mathbf{i} + \mathbf{j} + 2\mathbf{k}), \quad t \in [1, 3]$$
- 20** Give the coordinates of the endpoints of the line segment described by
- $$\mathbf{r} = 3\mathbf{i} + 4\mathbf{j} - 2\mathbf{k} + t(\mathbf{i} - 2\mathbf{j} + 2\mathbf{k}), \quad t \in [-1, 2]$$
- 21** A line is given by the vector equation $\mathbf{r} = \mathbf{i} - 4\mathbf{j} + \mathbf{k} + t(\mathbf{i} + 2\mathbf{j} - \mathbf{k})$, $t \in \mathbb{R}$.
- a** Find the vector \overrightarrow{OB} in terms of t , where B is a point on the line.
- b** Find $|\overrightarrow{OB}|$ in terms of t .
- c** Hence find the minimum value of $|\overrightarrow{OB}|$. That is, find the shortest distance from the origin to a point on the line.
- d** Let A be the point $(1, 3, 2)$. Find the shortest distance from A to a point on the line.



6B Intersection of lines and skew lines

► Lines in two-dimensional space

In Mathematical Methods, you have seen that there are two situations to consider for two distinct straight lines in the plane:

- the lines are parallel
- the lines meet at a single point.

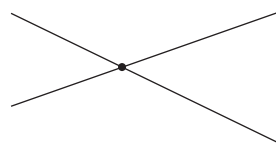
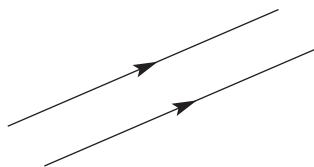

In two-dimensional space, a pair of lines are parallel, intersect or coincide.

For example, the two lines

$$\ell_1: \mathbf{r}_1 = 2\mathbf{i} + 2\mathbf{j} + \lambda(\mathbf{i} - \mathbf{j}), \lambda \in \mathbb{R} \quad \text{and} \quad \ell_2: \mathbf{r}_2 = 2\mathbf{i} + 3\mathbf{j} + \mu(2\mathbf{i} - 2\mathbf{j}), \mu \in \mathbb{R}$$

are parallel, since the direction vectors $\mathbf{i} - \mathbf{j}$ and $2\mathbf{i} - 2\mathbf{j}$ are parallel.

We can check whether these lines coincide by asking if the point on line ℓ_2 with position vector $2\mathbf{i} + 3\mathbf{j}$ also lies on line ℓ_1 . If it did, then we could find a value of λ such that

$$2 + \lambda = 2 \quad \text{and} \quad 2 - \lambda = 3$$

Clearly, no such λ exists, so the lines are parallel and distinct.

Example 7

Find the position vector of the point of intersection of the lines

$$\mathbf{r}_1 = 2\mathbf{i} + 2\mathbf{j} + \lambda(\mathbf{i} - \mathbf{j}), \lambda \in \mathbb{R} \quad \text{and} \quad \mathbf{r}_2 = -\mathbf{j} + \mu(3\mathbf{i} + 2\mathbf{j}), \mu \in \mathbb{R}$$

Solution

At the point of intersection, we have $\mathbf{r}_1 = \mathbf{r}_2$ and so

$$2\mathbf{i} + 2\mathbf{j} + \lambda(\mathbf{i} - \mathbf{j}) = -\mathbf{j} + \mu(3\mathbf{i} + 2\mathbf{j})$$

$$\therefore (2 + \lambda)\mathbf{i} + (2 - \lambda)\mathbf{j} = 3\mu\mathbf{i} + (-1 + 2\mu)\mathbf{j}$$

Equate coefficients of \mathbf{i} and \mathbf{j} :

$$2 + \lambda = 3\mu \quad (1)$$

$$2 - \lambda = -1 + 2\mu \quad (2)$$

Solve simultaneously by adding (1) and (2):

$$4 = -1 + 5\mu$$

Hence $\mu = 1$ and so $\lambda = 1$.

Substituting $\lambda = 1$ into the equation $\mathbf{r}_1 = 2\mathbf{i} + 2\mathbf{j} + \lambda(\mathbf{i} - \mathbf{j})$ gives $\mathbf{r}_1 = 3\mathbf{i} + \mathbf{j}$.

The point of intersection has position vector $3\mathbf{i} + \mathbf{j}$.

► Lines in three-dimensional space

In three dimensions, a pair of lines are parallel, intersect, coincide or are **skew**.

Skew lines

Two lines are **skew lines** if they do not intersect and are not parallel.

Two lines are skew if and only if they do not lie in the same plane.

The situation in three dimensions can be illustrated through considering a cube $ABCDEFGH$ as shown.

Lines AB and FG are skew. We can easily see that AB and FG do not lie in the same plane.

Lines AD and BH are also skew.

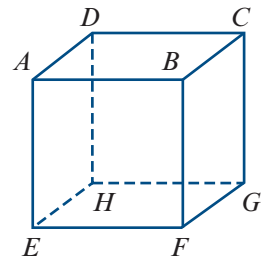

Parallel lines

Two lines $r_1 = a_1 + \lambda d_1$ and $r_2 = a_2 + \mu d_2$ are parallel or coincide if $d_1 = kd_2$ for some $k \in \mathbb{R}$.

Two parallel lines coincide if there is a point in common to both lines. To check this, we can attempt to find a value of μ such that $a_1 = a_2 + \mu d_2$. If such a μ exists, then the lines coincide. If such a μ does not exist, then the lines are parallel and distinct.

Example 8

Find the point of intersection of the lines

$$r_1 = 5i + 2j + \lambda(2i + j + k) \quad \text{and} \quad r_2 = -3i + 4j + 6k + \mu(i - j - 2k)$$

Solution

If $r_1 = r_2$, then

$$5i + 2j + \lambda(2i + j + k) = -3i + 4j + 6k + \mu(i - j - 2k)$$

Equate coefficients of i , j and k :

$$5 + 2\lambda = -3 + \mu \quad (1)$$

$$2 + \lambda = 4 - \mu \quad (2)$$

$$\lambda = 6 - 2\mu \quad (3)$$

From (1) and (2), we have

$$7 + 3\lambda = 1$$

$$\therefore \lambda = -2$$

Substitute in (1) to find $\mu = 4$.

Now we must check that these values also satisfy equation (3):

$$\text{RHS} = 6 - 2 \times 4 = -2 = \text{LHS}$$

Hence the lines intersect. The lines intersect at the point $(1, 0, -2)$

Example 9

Show that the following two lines are skew lines:

$$\mathbf{r}_1 = \mathbf{i} + \mathbf{k} + \lambda(\mathbf{i} + 3\mathbf{j} + 4\mathbf{k}), \quad \lambda \in \mathbb{R}$$

$$\mathbf{r}_2 = 2\mathbf{i} + 3\mathbf{j} + \mu(4\mathbf{i} - \mathbf{j} + \mathbf{k}), \quad \mu \in \mathbb{R}$$

Solution

We first note that the lines are not parallel, since $\mathbf{i} + 3\mathbf{j} + 4\mathbf{k} \neq m(4\mathbf{i} - \mathbf{j} + \mathbf{k})$, for all $m \in \mathbb{R}$.

We now show that the lines do not meet. If they did meet, then equating coefficients of \mathbf{i} , \mathbf{j} and \mathbf{k} would give

$$1 + \lambda = 2 + 4\mu \quad (1)$$

$$3\lambda = 3 - \mu \quad (2)$$

$$1 + 4\lambda = \mu \quad (3)$$

From (1) and (2), we have $\lambda = 1$ and $\mu = 0$. But this is not consistent with equation (3). So there are no values of λ and μ such that $\mathbf{r}_1 = \mathbf{r}_2$.

The two lines are skew, as they are not parallel and do not intersect.

► Concurrence of three lines

A point of **concurrence** is where three or more lines meet.

Example 10

Find the point of concurrence of the following three lines:

$$\ell_1: \quad \mathbf{r}_1 = -2\mathbf{i} + \mathbf{j} + t(\mathbf{i} + \mathbf{j}), \quad t \in \mathbb{R}$$

$$\ell_2: \quad \mathbf{r}_2 = \mathbf{j} + s(\mathbf{i} + 2\mathbf{j}), \quad s \in \mathbb{R}$$

$$\ell_3: \quad \mathbf{r}_3 = 8\mathbf{i} + 3\mathbf{j} + u(-3\mathbf{i} + \mathbf{j}), \quad u \in \mathbb{R}$$

Solution

The point of intersection of lines ℓ_1 and ℓ_2 can be found from the values of s and t such that $\mathbf{r}_1 = \mathbf{r}_2$. Equating coefficients of \mathbf{i} and \mathbf{j} , we obtain

$$-2 + t = s \quad (1)$$

$$1 + t = 1 + 2s \quad (2)$$

Solving simultaneously gives $s = 2$ and $t = 4$. Substituting in \mathbf{r}_1 gives $2\mathbf{i} + 5\mathbf{j}$.

Thus lines ℓ_1 and ℓ_2 intersect at the point $(2, 5)$.

For this to be a point of concurrence, the point must also lie on ℓ_3 . We must find a value of u such that

$$2\mathbf{i} + 5\mathbf{j} = 8\mathbf{i} + 3\mathbf{j} + u(-3\mathbf{i} + \mathbf{j})$$

We see that $u = 2$ gives the result. The three lines are concurrent at the point $(2, 5)$.

► Angle between two lines

If two lines have equations $\mathbf{r}_1 = \mathbf{a}_1 + \lambda \mathbf{d}_1$ and $\mathbf{r}_2 = \mathbf{a}_2 + \mu \mathbf{d}_2$, then they are in the directions of vectors \mathbf{d}_1 and \mathbf{d}_2 respectively. The angle θ between the two vectors \mathbf{d}_1 and \mathbf{d}_2 can be found using the scalar product:

$$\cos \theta = \frac{\mathbf{d}_1 \cdot \mathbf{d}_2}{|\mathbf{d}_1| |\mathbf{d}_2|}$$

The angle between the two lines is θ or $180^\circ - \theta$, whichever is in the interval $[0^\circ, 90^\circ]$.

This applies to a pair of skew lines, as well as to a pair of intersecting lines. The two lines are perpendicular if and only if $\mathbf{d}_1 \cdot \mathbf{d}_2 = 0$.

Example 11

Find the acute angle between the following two straight lines:

$$\mathbf{r}_1 = \mathbf{i} + 2\mathbf{j} + \lambda(5\mathbf{i} + 3\mathbf{j} - 2\mathbf{k})$$

$$\mathbf{r}_2 = 2\mathbf{i} - \mathbf{j} + 3\mathbf{k} + \mu(-2\mathbf{i} + 3\mathbf{j} + 5\mathbf{k})$$

Solution

The vectors $\mathbf{d}_1 = 5\mathbf{i} + 3\mathbf{j} - 2\mathbf{k}$ and $\mathbf{d}_2 = -2\mathbf{i} + 3\mathbf{j} + 5\mathbf{k}$ give the directions of the two lines.

We have $|\mathbf{d}_1| = \sqrt{38}$, $|\mathbf{d}_2| = \sqrt{38}$ and $\mathbf{d}_1 \cdot \mathbf{d}_2 = -11$.

Let θ be the angle between \mathbf{d}_1 and \mathbf{d}_2 . Then $\cos \theta = -\frac{11}{38}$.

The acute angle between the lines is 73.17° , correct to two decimal places.

Exercise 6B

- Example 7** 1 Find the position vector of the point of intersection of the lines with equations $\mathbf{r}_1 = 3\mathbf{i} + 5\mathbf{j} + \lambda(2\mathbf{i} - \mathbf{j})$ and $\mathbf{r}_2 = -2\mathbf{j} + \mu(4\mathbf{i} + 2\mathbf{j})$.
- Example 8** 2 Find the coordinates of the point of intersection of the lines with equations $\mathbf{r}_1 = \mathbf{i} + 3\mathbf{j} + \mathbf{k} + \lambda(-2\mathbf{i} - \mathbf{j} + 2\mathbf{k})$ and $\mathbf{r}_2 = -3\mathbf{i} + 4\mathbf{j} + 7\mathbf{k} + \mu(\mathbf{i} - \mathbf{j} - 2\mathbf{k})$.
- Example 9** 3 Show that $\mathbf{r}_1 = 3\mathbf{i} + 2\mathbf{j} + \mathbf{k} + \lambda(2\mathbf{i} - 3\mathbf{j} + \mathbf{k})$ and $\mathbf{r}_2 = \mathbf{i} - 3\mathbf{j} + 2\mathbf{k} + \mu(\mathbf{i} - 2\mathbf{j} + 3\mathbf{k})$ are skew lines.
- 4 For each pair of lines, answer the following questions:
- Are the lines parallel?
 - Are the lines perpendicular?
 - Do the lines coincide?
 - If they intersect at a point, what is the point of intersection?
- a** $\mathbf{r}_1 = \mathbf{i} + 2\mathbf{j} + t(\mathbf{i} + \mathbf{j})$
 $\mathbf{r}_2 = -\mathbf{i} + 6\mathbf{j} + s(\mathbf{i} + 2\mathbf{j})$
- b** $\mathbf{r}_1 = -\mathbf{i} + \mathbf{j} + t(\mathbf{i} + 2\mathbf{j})$
 $\mathbf{r}_2 = 3\mathbf{i} - \mathbf{j} + s(-2\mathbf{i} + \mathbf{j})$

$$\begin{aligned} \mathbf{c} \quad r_1 &= 5i + 9j + t(-2i - 3j) \\ r_2 &= i + 3j + s(4i + 6j) \end{aligned}$$

$$\begin{aligned} \mathbf{e} \quad r_1 &= 5i + 5j - 4k + t(i + 2j - k) \\ r_2 &= 4j + k + s(i - j - k) \end{aligned}$$

$$\begin{aligned} \mathbf{g} \quad r_1 &= 6i - 6j + 5k + t(i - 2j + 2k) \\ r_2 &= i + 2j - 5k + s(i - j + 2k) \end{aligned}$$

$$\begin{aligned} \mathbf{i} \quad r_1 &= -3i - j + t(3i + 2j - 2k) \\ r_2 &= 4i + j - 6k + s(i - k) \end{aligned}$$

$$\begin{aligned} \mathbf{d} \quad r_1 &= i - 4j + t(2i - j) \\ r_2 &= 7i + 8j + s(-2i + j) \end{aligned}$$

$$\begin{aligned} \mathbf{f} \quad r_1 &= 7i + 4j + 5k + t(3i + j - k) \\ r_2 &= j - 3k + s(i + 4j + 2k) \end{aligned}$$

$$\begin{aligned} \mathbf{h} \quad r_1 &= 4i - 5j + k + t(2i - 4j - 2k) \\ r_2 &= -i + 5j + 6k + s(-i + 2j + k) \end{aligned}$$

$$\begin{aligned} \mathbf{j} \quad r_1 &= 7i - 6j + t(2i - 2j + k) \\ r_2 &= -3i + 4j - 5k + s(2i - 2j + k) \end{aligned}$$

Example 10

5 For each of the following, find the point of concurrence (if it exists) of the lines:

$$\begin{aligned} \mathbf{a} \quad r_1 &= 3i + 2j - 3k + t(i - k) \\ r_2 &= 2i + 3j + s(i + j + k) \\ r_3 &= -i + 4j + 3k + u(-i + j + 2k) \end{aligned}$$

$$\begin{aligned} \mathbf{b} \quad r_1 &= 2i + j - 3k + t(i - j + k) \\ r_2 &= 25i + 6j - 2k + s(i + 3j) \\ r_3 &= 5i + j - k + u(2i + j + k) \end{aligned}$$

$$\begin{aligned} \mathbf{c} \quad r_1 &= 5i - j + t(i + k) \\ r_2 &= 10i + 5j - k + s(i + 2j - k) \\ r_3 &= 5i - 2j - k + u(2i + j + 2k) \end{aligned}$$

$$\begin{aligned} \mathbf{d} \quad r_1 &= -5i - 2j + 8k + t(2i - k) \\ r_2 &= 2i - 3j + 4k + s(i - j - k) \\ r_3 &= 5i + 8j + u(2i + j + 2k) \end{aligned}$$

Example 11

6 Find the acute angle between each of the following pairs of lines:

$$\begin{aligned} \mathbf{a} \quad r_1 &= 3i + 2j - 4k + t(i + 2j + 2k) \\ r_2 &= 5j - 2k + s(3i + 2j + 6k) \end{aligned}$$

$$\begin{aligned} \mathbf{b} \quad r_1 &= 4i - j + t(i + 2j - 2k) \\ r_2 &= i - j + 2k - s(2i + 4j - 4k) \end{aligned}$$

7 The lines ℓ_1 and ℓ_2 are given by the equations

$$\begin{aligned} \ell_1: \quad r_1 &= i + 6j + 3k + t(2i - j + k) \\ \ell_2: \quad r_2 &= 3i + 3j + 8k + s(i + k) \end{aligned}$$

a Find the acute angle between the lines. **b** Show that the lines are skew lines.

8 The lines ℓ_1 and ℓ_2 are given by the equations

$$\begin{aligned} \ell_1: \quad r_1 &= 3i + j + t(2j + k) \\ \ell_2: \quad r_2 &= 4k + s(i + j - k) \end{aligned}$$

a Find the coordinates of the point of intersection of the lines.
b Find the cosine of the angle between the lines.

9 Three lines are represented by vector equations as follows:

$$\begin{aligned} \ell_1: \quad r_1 &= i - 2k + t_1(i + 3j + k), & t_1 &\in \mathbb{R} \\ \ell_2: \quad r_2 &= 2i - j + k + t_2(-i + 2j + k), & t_2 &\in \mathbb{R} \\ \ell_3: \quad r_3 &= 3i - j - k + t_3(i - 4j), & t_3 &\in \mathbb{R} \end{aligned}$$



For each pair of lines, determine whether they intersect or not. If they intersect, then find their point of intersection.

6C Vector product

Vector product is an operation that takes two vectors and produces another vector.

► Geometric definition of vector product

Definition of vector product

The **vector product** of \mathbf{a} and \mathbf{b} is denoted by $\mathbf{a} \times \mathbf{b}$.

- The magnitude of $\mathbf{a} \times \mathbf{b}$ is equal to $|\mathbf{a}||\mathbf{b}|\sin\theta$, where θ is the angle between \mathbf{a} and \mathbf{b} .
- The direction of $\mathbf{a} \times \mathbf{b}$ is perpendicular to the plane containing \mathbf{a} and \mathbf{b} , in the sense of a right-hand screw turned from \mathbf{a} to \mathbf{b} . (This is explained below.)

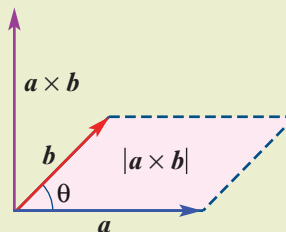

Note: Vector product is often called **cross product**.

The magnitude of $\mathbf{a} \times \mathbf{b}$

By definition, we have $|\mathbf{a} \times \mathbf{b}| = |\mathbf{a}||\mathbf{b}|\sin\theta$, where θ is the angle between \mathbf{a} and \mathbf{b} .

From the diagram on the right, we see that $|\mathbf{a} \times \mathbf{b}|$ is the area of the parallelogram ‘spanned’ by the vectors \mathbf{a} and \mathbf{b} .

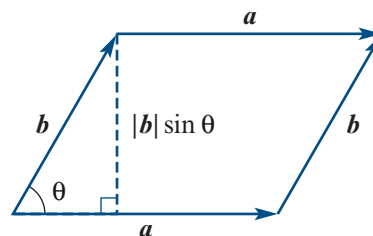

The direction of $\mathbf{a} \times \mathbf{b}$

To find the direction of the vector $\mathbf{a} \times \mathbf{b}$, curl the fingers of your right hand from the direction of \mathbf{a} around to the direction of \mathbf{b} . Your thumb will be pointing in the direction of $\mathbf{a} \times \mathbf{b}$.

The following two diagrams show $\mathbf{a} \times \mathbf{b}$ and $\mathbf{b} \times \mathbf{a}$.

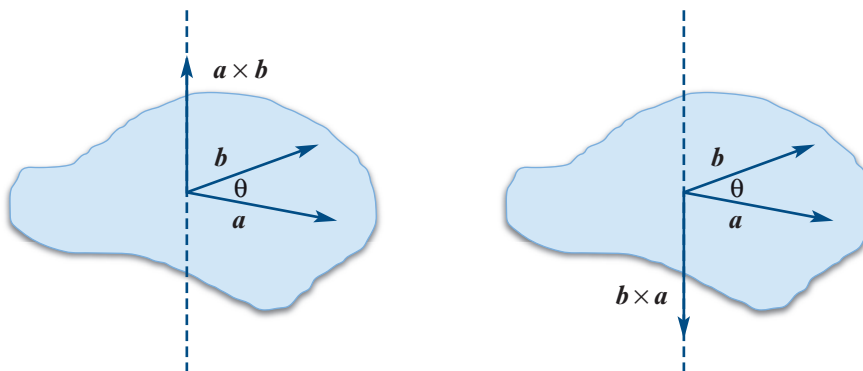

The vector $\mathbf{b} \times \mathbf{a}$ has the same magnitude as $\mathbf{a} \times \mathbf{b}$, but the opposite direction. We can see that

$$\mathbf{b} \times \mathbf{a} = -(\mathbf{a} \times \mathbf{b})$$

Thus vector product is *not* commutative.

Note: Vector product is also not associative: in general, we have $(\mathbf{a} \times \mathbf{b}) \times \mathbf{c} \neq \mathbf{a} \times (\mathbf{b} \times \mathbf{c})$.

Vector product of parallel vectors

If \mathbf{a} and \mathbf{b} are parallel vectors, then $\mathbf{a} \times \mathbf{b} = \mathbf{0}$, since $|\mathbf{a} \times \mathbf{b}| = |\mathbf{a}||\mathbf{b}|\sin 0^\circ = 0$.

Vector product of perpendicular vectors

If \mathbf{a} and \mathbf{b} are perpendicular vectors, then

$$\begin{aligned} |\mathbf{a} \times \mathbf{b}| &= |\mathbf{a}||\mathbf{b}|\sin 90^\circ \\ &= |\mathbf{a}||\mathbf{b}| \end{aligned}$$

The three vectors \mathbf{a} , \mathbf{b} and $\mathbf{a} \times \mathbf{b}$ form a right-handed system of mutually perpendicular vectors, as shown in the diagram.

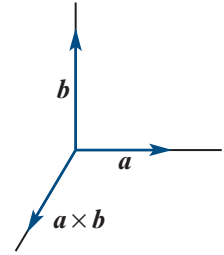

► Vector product in component form

Using these observations about the vector product of parallel and perpendicular vectors:

$$\begin{array}{lll} \blacksquare \mathbf{i} \times \mathbf{i} = \mathbf{0} & \blacksquare \mathbf{j} \times \mathbf{j} = \mathbf{0} & \blacksquare \mathbf{k} \times \mathbf{k} = \mathbf{0} \\ \blacksquare \mathbf{i} \times \mathbf{j} = \mathbf{k} & \blacksquare \mathbf{j} \times \mathbf{k} = \mathbf{i} & \blacksquare \mathbf{k} \times \mathbf{i} = \mathbf{j} \\ \blacksquare \mathbf{j} \times \mathbf{i} = -\mathbf{k} & \blacksquare \mathbf{k} \times \mathbf{j} = -\mathbf{i} & \blacksquare \mathbf{i} \times \mathbf{k} = -\mathbf{j} \end{array}$$

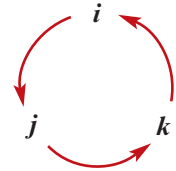

Vector product distributes over addition. That is:

$$\mathbf{a} \times (\mathbf{b} + \mathbf{c}) = \mathbf{a} \times \mathbf{b} + \mathbf{a} \times \mathbf{c}$$

These facts can be used to establish the following result.

Vector product in component form

If $\mathbf{a} = a_1\mathbf{i} + a_2\mathbf{j} + a_3\mathbf{k}$ and $\mathbf{b} = b_1\mathbf{i} + b_2\mathbf{j} + b_3\mathbf{k}$, then

$$\mathbf{a} \times \mathbf{b} = (a_2b_3 - a_3b_2)\mathbf{i} - (a_1b_3 - a_3b_1)\mathbf{j} + (a_1b_2 - a_2b_1)\mathbf{k}$$

Note: A way of remembering this formula is to use the ‘determinant’ of the 3×3 matrix

$$\begin{bmatrix} \mathbf{i} & \mathbf{j} & \mathbf{k} \\ a_1 & a_2 & a_3 \\ b_1 & b_2 & b_3 \end{bmatrix}$$

This can be ‘evaluated’ as

$$\begin{aligned} \mathbf{a} \times \mathbf{b} &= \begin{vmatrix} \mathbf{i} & \mathbf{j} & \mathbf{k} \\ a_1 & a_2 & a_3 \\ b_1 & b_2 & b_3 \end{vmatrix} = \begin{vmatrix} a_2 & a_3 \\ b_2 & b_3 \end{vmatrix} \mathbf{i} - \begin{vmatrix} a_1 & a_3 \\ b_1 & b_3 \end{vmatrix} \mathbf{j} + \begin{vmatrix} a_1 & a_2 \\ b_1 & b_2 \end{vmatrix} \mathbf{k} \\ &= (a_2b_3 - a_3b_2)\mathbf{i} - (a_1b_3 - a_3b_1)\mathbf{j} + (a_1b_2 - a_2b_1)\mathbf{k} \end{aligned}$$

To obtain the \mathbf{i} -component, we ‘delete’ the \mathbf{i} -row and the \mathbf{i} -column of the 3×3 matrix. Likewise for the \mathbf{j} - and \mathbf{k} -components.

The final step of this method uses the determinant of a 2×2 matrix, which may be familiar to you from Specialist Mathematics Year 11. (Here we are using $|\mathbf{A}|$ to denote the determinant of a square matrix \mathbf{A} .)

Example 12

Find the vector product of $\mathbf{a} = 3\mathbf{i} + 3\mathbf{j} + 8\mathbf{k}$ and $\mathbf{b} = \mathbf{i} - 3\mathbf{j} + 2\mathbf{k}$, and hence find a unit vector that is perpendicular to both \mathbf{a} and \mathbf{b} .

Solution

The vector product can be ‘evaluated’ as follows:

$$\begin{aligned} \mathbf{a} \times \mathbf{b} &= \begin{vmatrix} \mathbf{i} & \mathbf{j} & \mathbf{k} \\ 3 & 3 & 8 \\ 1 & -3 & 2 \end{vmatrix} = \begin{vmatrix} 3 & 8 \\ -3 & 2 \end{vmatrix} \mathbf{i} - \begin{vmatrix} 3 & 8 \\ 1 & 2 \end{vmatrix} \mathbf{j} + \begin{vmatrix} 3 & 3 \\ 1 & -3 \end{vmatrix} \mathbf{k} \\ &= (3 \times 2 - 8 \times (-3))\mathbf{i} - (3 \times 2 - 8 \times 1)\mathbf{j} + (3 \times (-3) - 3 \times 1)\mathbf{k} \\ &= 30\mathbf{i} + 2\mathbf{j} - 12\mathbf{k} \end{aligned}$$

The magnitude of $\mathbf{a} \times \mathbf{b}$ is $\sqrt{30^2 + 2^2 + 12^2} = 2\sqrt{262}$.

Hence a unit vector perpendicular to both \mathbf{a} and \mathbf{b} is $\frac{1}{2\sqrt{262}}(30\mathbf{i} + 2\mathbf{j} - 12\mathbf{k})$.

Using the TI-Nspire

- Define (assign) the vectors $\mathbf{a} = 3\mathbf{i} + 3\mathbf{j} + 8\mathbf{k}$ and $\mathbf{b} = \mathbf{i} - 3\mathbf{j} + 2\mathbf{k}$ as shown.
- Find the vector product using **(menu) > Matrix & Vector > Vector > Cross Product**. The vector product is $30\mathbf{i} + 2\mathbf{j} - 12\mathbf{k}$.
- The scalar product of two vectors can also be found, using **(menu) > Matrix & Vector > Vector > Dot Product**.

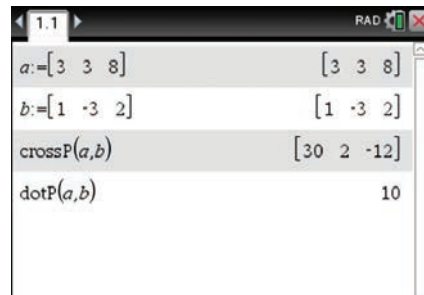

Note: You can enter the matrices directly into the vector commands if preferred.

Using the Casio ClassPad

To find the vector product of two vectors:

- In $\sqrt{\alpha}$, go to **Interactive > Vector > crossP**.
- Tap the cursor in the first entry box.
- Select the vector icon [] from the **(Math3)** keyboard.
- Enter the components of the first vector, separated by commas.
- Tap the cursor in the second entry box, enter the second vector and tap OK.

Note: The scalar product of two vectors can be found similarly using **Interactive > Vector > dotP**.

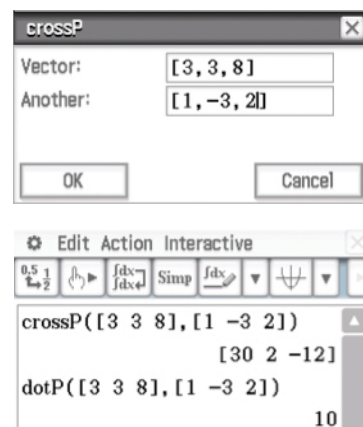

Example 13

a Simplify:

i $a \times (a - b)$ **ii** $(a \times b) \cdot a$

b Given that $a \times b = c \times a$, with $a \neq \mathbf{0}$, show that $b = -c$ or $a = k(b + c)$ for some $k \in \mathbb{R}$.

Solution

a i $a \times (a - b) = a \times a - a \times b = -a \times b$

ii Since $a \times b$ is perpendicular to a , we have $(a \times b) \cdot a = 0$.

b By assumption, we have

$$a \times b = c \times a$$

$$a \times b - c \times a = \mathbf{0}$$

$$a \times b + a \times c = \mathbf{0}$$

$$\therefore a \times (b + c) = \mathbf{0}$$

Since $a \neq \mathbf{0}$, it follows that either $b + c = \mathbf{0}$ or the vectors a and $b + c$ are parallel.

Hence we must have $b = -c$ or $a = k(b + c)$ for some $k \in \mathbb{R}$.

Exercise 6C

Skillsheet

1 Use the vector product to find a vector perpendicular to the two given vectors:

Example 12

a $i - 4j + k$ and $4i + 3j$

b $3i + j - k$ and $i - j + 2k$

c $i + j - k$ and k

d $2i + 2j - k$ and $2j$

2 Use the vector product to find a vector perpendicular to the two given vectors:

a $2i - 3j + 5k$ and $-4i + 3k$

b $3i + j - 2k$ and $-i - j + 2k$

c $-2i + j - 2k$ and i

d $-2i - k$ and $2j$

Example 13

3 Simplify:

a $(a + b) \times b$

b $(a + b) \times (a + b)$

c $(a - b) \times (a + b)$

d $(a \times (b + c)) \cdot b$

e $a \cdot ((b + c) \times a)$

f $((a \times b) \cdot a) + (b \cdot (a \times b))$

4 Find a vector of magnitude 5 that is perpendicular to $a = 2i + 3j - k$ and $b = i - 2j + 2k$.

5 The three vertices of a triangle have position vectors a , b and c . Show that the area of the triangle is $\frac{1}{2}|a \times b + b \times c + c \times a|$.

6 A parallelogram $OABC$ has one vertex at the origin O and two other vertices at the points $A(0, 1, 3)$ and $B(0, 2, 5)$. Find the area of $OABC$.

7 Find the area of the triangle PQR with vertices $P(1, 5, -2)$, $Q(0, 0, 0)$ and $R(3, 5, 1)$.

8 Let v be a vector parallel to a line ℓ , and let u be a vector from any point on the line to a point P not on the line. Show that the distance from the point P to the line ℓ is $\frac{|u \times v|}{|v|}$.



6D Vector equations of planes

► Normal vectors to planes

For any smooth surface, at each point on the surface there is a line perpendicular to the surface. For a plane, these perpendiculars are all in the same direction.

A vector that is perpendicular to a plane is called a **normal** to the plane.

Note: There is not a unique normal vector for a given plane.

If the vector \mathbf{n} is normal to the plane, then so are the vectors $k\mathbf{n}$ and $-\mathbf{n}$, for all $k \in \mathbb{R}^+$.

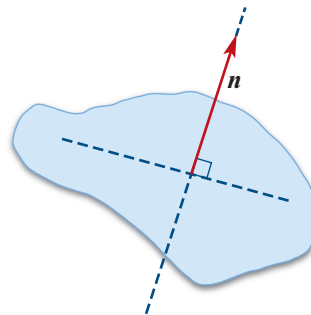

► Equations of planes

A plane Π in three-dimensional space may be described using two vectors:

- the position vector \mathbf{a} of a point A on the plane
- a vector \mathbf{n} that is normal to the plane.

Let \mathbf{r} be the position vector of any other point P on the plane. Then the vector $\overrightarrow{AP} = \mathbf{r} - \mathbf{a}$ lies in the plane, and is therefore perpendicular to \mathbf{n} . Hence

$$(\mathbf{r} - \mathbf{a}) \cdot \mathbf{n} = 0$$

This can be written as

$$\mathbf{r} \cdot \mathbf{n} = \mathbf{a} \cdot \mathbf{n}$$

This is a **vector equation** of the plane.

If we write the position vector of the point P as $\mathbf{r} = xi + yj + zk$ and write the normal vector as $\mathbf{n} = n_1\mathbf{i} + n_2\mathbf{j} + n_3\mathbf{k}$, then we obtain a **Cartesian equation** of the plane:

$$n_1x + n_2y + n_3z = \mathbf{a} \cdot \mathbf{n}$$

This is often written as

$$n_1x + n_2y + n_3z = k$$

where $k = \mathbf{a} \cdot \mathbf{n}$.

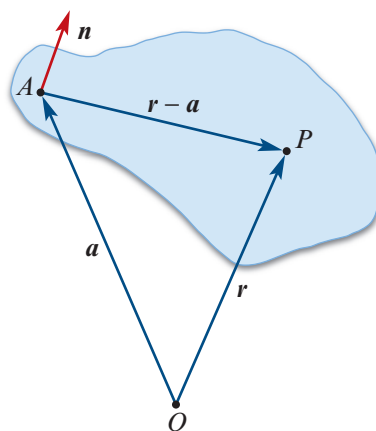

Planes in three dimensions

A plane in three-dimensional space can be described as follows, where \mathbf{a} is the position vector of a point A on the plane, the vector $\mathbf{n} = n_1\mathbf{i} + n_2\mathbf{j} + n_3\mathbf{k}$ is normal to the plane, and $k = \mathbf{a} \cdot \mathbf{n}$.

Vector equation	Cartesian equation
$\mathbf{r} \cdot \mathbf{n} = \mathbf{a} \cdot \mathbf{n}$	$n_1x + n_2y + n_3z = k$

Finding the plane determined by a point and a normal vector

The following example illustrates two methods for finding an equation of a plane.



Example 14

For a plane Π , the vector $-i + 5j - 3k$ is normal to the plane and the point A with position vector $-3i + 4j + 6k$ is on the plane. Find a vector equation and a Cartesian equation of the plane.

Solution

Method 1: Finding a vector equation first

Using the form $\mathbf{r} \cdot \mathbf{n} = \mathbf{a} \cdot \mathbf{n}$, a vector equation is

$$\mathbf{r} \cdot (-i + 5j - 3k) = (-3i + 4j + 6k) \cdot (-i + 5j - 3k)$$

i.e. $\mathbf{r} \cdot (-i + 5j - 3k) = 5$

For a Cartesian equation, write $\mathbf{r} = xi + yj + zk$. Then

$$(xi + yj + zk) \cdot (-i + 5j - 3k) = 5$$

i.e. $-x + 5y - 3z = 5$

Method 2: Finding a Cartesian equation first

The vector $\mathbf{n} = -i + 5j - 3k$ is normal to the plane, so a Cartesian equation is

$$-x + 5y - 3z = k$$

for some $k \in \mathbb{R}$. Since the point $A(-3, 4, 6)$ is on the plane, we have

$$-(-3) + 5(4) - 3(6) = k$$

Therefore $k = 5$, and a Cartesian equation is $-x + 5y - 3z = 5$.

Hence a vector equation is $\mathbf{r} \cdot (-i + 5j - 3k) = 5$.

Finding the plane determined by three points

Three points determine a plane provided they are not collinear.

Example 15

Consider the plane containing the points $A(0, 1, 1)$, $B(2, 1, 0)$ and $C(-2, 0, 3)$.

- Find a Cartesian equation of the plane.
- Find the axis intercepts of the plane, and hence sketch a graph of the plane.

Solution

a $\overrightarrow{AB} = 2i - k$ and $\overrightarrow{AC} = -2i - j + 2k$

The vector product $\overrightarrow{AB} \times \overrightarrow{AC}$ is $-i - 2j - 2k$.

Therefore the vector $\mathbf{n} = -i - 2j - 2k$ is normal to the plane.

Using the point A and the normal \mathbf{n} , we can use either of the two methods to find the Cartesian equation $-x - 2y - 2z = -4$.

b We can write the Cartesian equation of the plane more neatly as $x + 2y + 2z = 4$.

x-axis intercept: Let $y = z = 0$. Then $x = 4$.

y-axis intercept: Let $x = z = 0$. Then $2y = 4$, so $y = 2$.

z-axis intercept: Let $x = y = 0$. Then $2z = 4$, so $z = 2$.

The axis intercepts of the plane are $(4, 0, 0)$, $(0, 2, 0)$ and $(0, 0, 2)$.

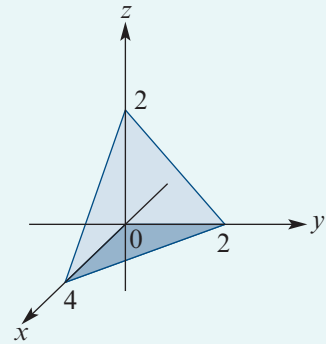

Using the TI-Nspire

To find a Cartesian equation of the plane containing $A(0, 1, 1)$, $B(2, 1, 0)$ and $C(-2, 0, 3)$:

- Define (assign) the three matrices as shown.
- Find the vector product using **menu** > **Matrix & Vector** > **Vector** > **Cross Product**.
- Display the Cartesian equation using the **Dot Product** command as shown.

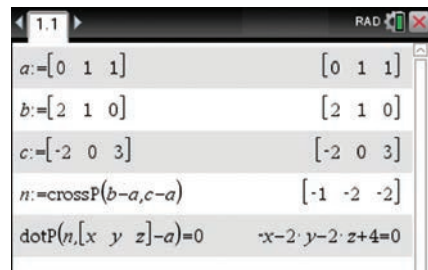

To plot the Cartesian equation as a plane:

- Solve the Cartesian equation for z .
- In a **Graphs** application, use **menu** > **View** > **3D Graphing**. Enter the expression for z in $z1(x, y)$, i.e. $z1(x, y) = \frac{-(x+2(y-2))}{2}$
- To rotate the view of the plane, use **menu** > **Actions** > **Rotate** (or press **r**) and then use the arrow keys.
- Use **menu** to change other attributes as desired.

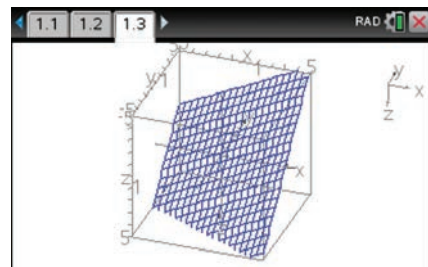
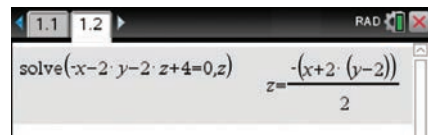

Using the Casio ClassPad

To find a Cartesian equation of the plane containing $A(0, 1, 1)$, $B(2, 1, 0)$ and $C(-2, 0, 3)$:

- Store the position vectors by assigning them to the variables a , b and c as shown.
- Go to **Interactive** > **Vector** > **crossP**. Enter $b - a$ as the first vector, and $c - a$ as the second vector. Tap **OK**.
- Assign the vector product to the variable n as shown.

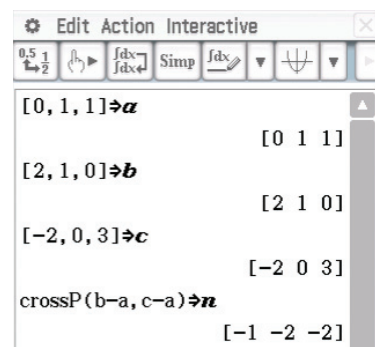





- Go to **Interactive > Vector > dotP**. Enter \mathbf{n} as the first vector, and $[x, y, z] - \mathbf{a}$ as the second vector. Tap OK.
- At the end of the dotP expression, type $= 0$. Highlight and simplify to obtain the equation.

$$\text{simplify}(\text{dotP}(\mathbf{n}, [x \ y \ z] - \mathbf{a}) = 0)$$

$$-x - 2 \cdot y - 2 \cdot z + 4 = 0$$

To plot the Cartesian equation as a plane:

- Solve the Cartesian equation for z .
- Copy the equation. Then open the menu  and select **3D Graph** .
- Paste the equation in $z1$ and tap the circle.
- Tap  to view the graph.
- Tap in the graph window; then tap  to reveal the axes or box.
- Tap on the diamond in the menu bar to select the desired rotation option.

$$\text{solve}(-x - 2 \cdot y - 2 \cdot z + 4 = 0, z)$$

$$\left\{ z = \frac{-x}{2} - y + 2 \right\}$$

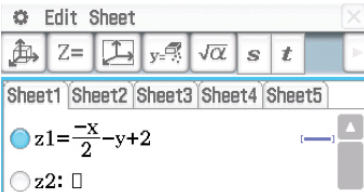
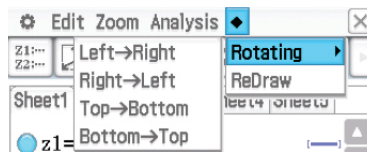
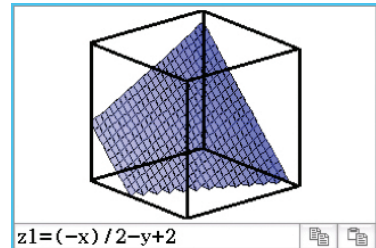
Finding the plane determined by two intersecting lines

Two lines that intersect at a single point can be used to determine a plane.

Example 16

Find a vector equation and a Cartesian equation of the plane containing the lines

$$\mathbf{r}_1 = 5\mathbf{i} + 2\mathbf{j} + \lambda(2\mathbf{i} + \mathbf{j} + \mathbf{k})$$

$$\mathbf{r}_2 = -3\mathbf{i} + 4\mathbf{j} + 6\mathbf{k} + \mu(\mathbf{i} - \mathbf{j} - 2\mathbf{k})$$

Note: From Example 8, we know that these lines intersect at the point $(1, 0, -2)$.

Solution

We know that $\mathbf{a} = 5\mathbf{i} + 2\mathbf{j}$ is the position vector of a point on the plane.

We want to find a normal vector. It must be perpendicular to both $\mathbf{d}_1 = 2\mathbf{i} + \mathbf{j} + \mathbf{k}$ and $\mathbf{d}_2 = \mathbf{i} - \mathbf{j} - 2\mathbf{k}$, so we can choose

$$\mathbf{n} = \mathbf{d}_1 \times \mathbf{d}_2 = -\mathbf{i} + 5\mathbf{j} - 3\mathbf{k}$$

Hence a vector equation of the plane is

$$\mathbf{r} \cdot \mathbf{n} = \mathbf{a} \cdot \mathbf{n}$$

i.e. $\mathbf{r} \cdot (-\mathbf{i} + 5\mathbf{j} - 3\mathbf{k}) = 5$

The corresponding Cartesian equation is $-x + 5y - 3z = 5$.

Exercise 6D

Skillsheet

Example 14

- 1 In each of the following, a vector \mathbf{n} normal to the plane and a point A on the plane are given. Find a vector equation and a Cartesian equation of each plane.

a $\mathbf{n} = \mathbf{i} + \mathbf{j} + \mathbf{k}$, $A(1, -2, 4)$

b $\mathbf{n} = \mathbf{i} - 2\mathbf{k}$, $A(3, 1, 0)$

c $\mathbf{n} = 2\mathbf{i} + 3\mathbf{j} - \mathbf{k}$, $A(2, -3, -5)$

d $\mathbf{n} = \mathbf{i} + 3\mathbf{j} - \mathbf{k}$, $A(1, -2, 3)$

Example 15

- 2 Points $A = (2, 1, -1)$, $B = (1, 3, 1)$ and $C = (3, -2, 2)$ lie in a plane. Find a unit vector normal to this plane and find a vector equation of this plane.

Example 16

- 3 Find a vector equation and a Cartesian equation of the plane containing the lines $\mathbf{r}_1 = \mathbf{i} - 10\mathbf{j} + 4\mathbf{k} + \lambda(2\mathbf{i} - \mathbf{j} + \mathbf{k})$ and $\mathbf{r}_2 = -3\mathbf{i} - 2\mathbf{j} + \mu(\mathbf{i} - 2\mathbf{j} + \mathbf{k})$.

- 4 The point $A = (-3, 1, 1)$ and the line ℓ lie in the same plane. The line ℓ is defined by the equation $\mathbf{r} = \mathbf{i} - 4\mathbf{j} + \mathbf{k} + t(\mathbf{i} + 2\mathbf{j} - \mathbf{k})$, $t \in \mathbb{R}$.

a Find a vector normal to this plane.

b Find a vector equation of the line through A that is normal to this plane.

- 5 Points $A = (1, 1, 3)$, $B = (1, 5, -2)$ and $C = (0, 3, -1)$ lie in a plane. Find a unit vector normal to this plane and find a vector equation of this plane.

- 6 A plane is defined by the vector equation $\mathbf{r} \cdot (2\mathbf{i} - \mathbf{j} - 3\mathbf{k}) = 7$. Show that each of the following is the position vector of a point on this plane:

a $\mathbf{i} - 2\mathbf{j} - \mathbf{k}$

b $3\mathbf{i} - 4\mathbf{j} + \mathbf{k}$

c $-\mathbf{i} + 3\mathbf{j} - 4\mathbf{k}$

d $2\mathbf{j} - 3\mathbf{k}$

- 7 A plane is defined by the vector equation $\mathbf{r} \cdot (3\mathbf{i} + \mathbf{j} - \mathbf{k}) = 10$. Show that each of the following is a point on this plane:

a $(2, 2, -2)$

b $(1, 5, -2)$

c $(3, 4, 3)$

d $(2, 0, -4)$

- 8 Find x in each of the following:

a The point $(1, x, 2)$ lies on the plane given by the equation $\mathbf{r} \cdot (-\mathbf{i} + \mathbf{j} + 3\mathbf{k}) = 5$.

b The point $(2, -1, 0)$ lies on the plane given by the equation $\mathbf{r} \cdot (3\mathbf{i} + 2\mathbf{k}) = x$.

c The point $(1, -3, 2)$ lies on the plane given by the equation $\mathbf{r} \cdot (2\mathbf{i} + x\mathbf{k}) = 8$.

d The point $(x, 1, -2)$ lies on the plane given by the equation $\mathbf{r} \cdot (\mathbf{i} + 3\mathbf{j} + \mathbf{k}) = 5$.

- 9 Find a Cartesian equation of the plane containing the three points $A(0, 3, 4)$, $B(1, 2, 0)$ and $C(-1, 6, 4)$.

- 10 Find a Cartesian equation of the plane that is at right angles to the line given by $x = 4 + t$, $y = 1 - 2t$, $z = 8t$ and goes through the point $P(3, 2, 1)$.

- 11 Find a Cartesian equation of the plane that is parallel to the plane with equation $5x - 3y + 2z = 6$ and goes through the point $P(4, -1, 2)$.

- 12 Find a Cartesian equation of the plane that contains the intersecting lines given by $x = 4 + t_1$, $y = 2t_1$, $z = 1 - 3t_1$ and $x = 4 - 3t_2$, $y = 3t_2$, $z = 1 + 2t_2$.



- 13 Find a Cartesian equation of the plane that is at right angles to the plane with equation $3x + 2y - z = 4$ and goes through the points $P(1, 2, 4)$ and $Q(-1, 3, 2)$.

6E Distances, angles and intersections

► Distance from a point to a plane

The distance from a point P to a plane Π is given by

$$d = |\overrightarrow{PQ} \cdot \hat{n}|$$

where \hat{n} is a unit vector normal to the plane and Q is any point on the plane.

Proof For the situation shown in the diagram, we can see that the distance from P to the plane is

$$d = |\overrightarrow{PQ}| \cos \theta$$

where θ is the angle between \overrightarrow{PQ} and \hat{n} . Therefore

$$d = |\overrightarrow{PQ}| |\hat{n}| \cos \theta = \overrightarrow{PQ} \cdot \hat{n}$$

The other situation is where the unit normal \hat{n} points in the opposite direction. In this case, we will obtain $d = -\overrightarrow{PQ} \cdot \hat{n}$. Hence, in general, the distance is the absolute value of $\overrightarrow{PQ} \cdot \hat{n}$.

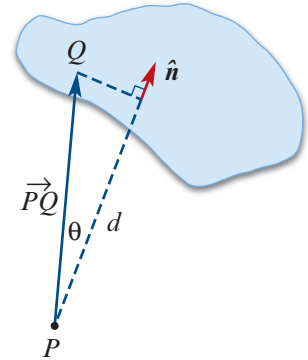

Example 17

Find the distance from the point $P(1, -4, -3)$ to the plane $\Pi: 2x - 3y + 6z = -1$.

Solution

A normal vector to the plane is $\mathbf{n} = 2\mathbf{i} - 3\mathbf{j} + 6\mathbf{k}$. So a unit vector normal to the plane is

$$\hat{n} = \frac{1}{7}(2\mathbf{i} - 3\mathbf{j} + 6\mathbf{k})$$

Let $Q(x, y, z)$ be any point on the plane. Note that this implies $2x - 3y + 6z = -1$.

We want to find the projection of \overrightarrow{PQ} onto \hat{n} . We have

$$\begin{aligned} \overrightarrow{PQ} &= \overrightarrow{OQ} - \overrightarrow{OP} \\ &= (x-1)\mathbf{i} + (y+4)\mathbf{j} + (z+3)\mathbf{k} \end{aligned}$$

Therefore

$$\begin{aligned} \overrightarrow{PQ} \cdot \hat{n} &= \frac{1}{7}(2(x-1) - 3(y+4) + 6(z+3)) \\ &= \frac{1}{7}(2x - 3y + 6z - 2 - 12 + 18) \\ &= \frac{1}{7}(-1 + 4) && \text{(since } 2x - 3y + 6z = -1) \\ &= \frac{3}{7} \end{aligned}$$

The distance from the point P to the plane Π is $\frac{3}{7}$.

► Distance of a plane from the origin

A plane that does not pass through the origin is described by a vector equation of the form $\mathbf{r} \cdot \mathbf{n} = k$, where $k \neq 0$.

The point M on the plane that is closest to the origin has a position vector of the form $\overrightarrow{OM} = m\hat{\mathbf{n}}$, where $|m|$ is the distance of the plane from the origin.

If \mathbf{n} points towards the plane from the origin, then $m > 0$, and if \mathbf{n} points away from the plane, then $m < 0$. So we can say that m is the ‘signed distance’ of the plane from the origin (relative to the normal vector \mathbf{n}).

Since the point M lies on the plane, we know that $(m\hat{\mathbf{n}}) \cdot \mathbf{n} = k$. But $(m\hat{\mathbf{n}}) \cdot \mathbf{n} = m(\hat{\mathbf{n}} \cdot \mathbf{n}) = m|\mathbf{n}|$. So we have $m|\mathbf{n}| = k$ and therefore $m = \frac{k}{|\mathbf{n}|}$.

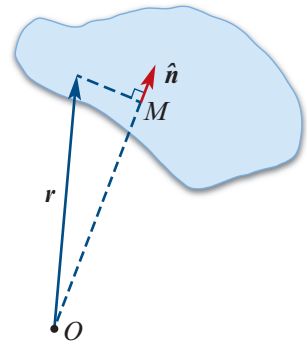

For a plane with vector equation $\mathbf{r} \cdot \mathbf{n} = k$, where $k \neq 0$, the signed distance of the plane from the origin (relative to the normal vector \mathbf{n}) is given by $\frac{k}{|\mathbf{n}|}$.

► Distance between two parallel planes

To find the distance between parallel planes Π_1 and Π_2 , we can choose any point P on Π_1 and then find the distance from the point P to the plane Π_2 .

In the following example, we use an alternative method.

Example 18

Consider the parallel planes given by the equations

$$\Pi_1: 2x - y + 2z = 5 \quad \text{and} \quad \Pi_2: 2x - y + 2z = -2$$

- Find the distance of each plane from the origin.
- Find the distance between the two planes.

Solution

The vector $\mathbf{n} = 2\mathbf{i} - \mathbf{j} + 2\mathbf{k}$ is normal to both planes, with $|\mathbf{n}| = 3$.

- Relative to \mathbf{n} , the signed distance of plane Π_1 from the origin is $\frac{5}{|\mathbf{n}|} = \frac{5}{3}$.
So the distance of plane Π_1 from the origin is $\frac{5}{3}$.

Relative to \mathbf{n} , the signed distance of plane Π_2 from the origin is $\frac{-2}{|\mathbf{n}|} = -\frac{2}{3}$.
So the distance of plane Π_2 from the origin is $\frac{2}{3}$.

- Relative to the normal vector \mathbf{n} , the two planes are on different sides of the origin. So the distance between them is $\frac{5}{3} + \frac{2}{3} = \frac{7}{3}$.

► Intersections and angles

Using normal vectors

- To find the angle between two planes, we first find the angle θ between two vectors \mathbf{n}_1 and \mathbf{n}_2 that are normal to the two planes. The angle between the planes is θ or $180^\circ - \theta$, whichever is in the interval $[0^\circ, 90^\circ]$.
- Two planes are parallel if and only if the two normal vectors are parallel.
- Two planes are perpendicular if and only if the two normal vectors are perpendicular.
- The angle between a line and a plane is equal to $90^\circ - \theta$, where θ is the angle between the line and a normal to the plane.

Intersection of a line and a plane

A line and a plane that are not parallel will intersect at a single point.

Example 19

Consider the line represented by the equation $\mathbf{r} = 3\mathbf{i} - \mathbf{j} - \mathbf{k} + t(\mathbf{i} + 2\mathbf{j} - \mathbf{k})$ and the plane represented by the equation $\mathbf{r} \cdot (\mathbf{i} + \mathbf{j} + 2\mathbf{k}) = 2$.

- a Find the point of intersection of the line and the plane.
- b Find the angle between the line and the plane.

Solution

- a To find the point of intersection, we want to find the value of t for which

$$\mathbf{r} = 3\mathbf{i} - \mathbf{j} - \mathbf{k} + t(\mathbf{i} + 2\mathbf{j} - \mathbf{k})$$

represents a point on the plane. That is,

$$(3\mathbf{i} - \mathbf{j} - \mathbf{k} + t(\mathbf{i} + 2\mathbf{j} - \mathbf{k})) \cdot (\mathbf{i} + \mathbf{j} + 2\mathbf{k}) = 2$$

$$(3 + t) + (-1 + 2t) + 2(-1 - t) = 2$$

$$\therefore t = 2$$

The point of intersection has position vector

$$\mathbf{r} = 3\mathbf{i} - \mathbf{j} - \mathbf{k} + 2(\mathbf{i} + 2\mathbf{j} - \mathbf{k}) = 5\mathbf{i} + 3\mathbf{j} - 3\mathbf{k}$$

The point of intersection is $(5, 3, -3)$.

- b We first find the angle between the line and the normal to the plane.

The vector $\mathbf{d} = \mathbf{i} + 2\mathbf{j} - \mathbf{k}$ is parallel to the line, and the vector $\mathbf{n} = \mathbf{i} + \mathbf{j} + 2\mathbf{k}$ is normal to the plane. Let θ be the angle between \mathbf{d} and \mathbf{n} . Then

$$\mathbf{d} \cdot \mathbf{n} = |\mathbf{d}| |\mathbf{n}| \cos \theta$$

$$(\mathbf{i} + 2\mathbf{j} - \mathbf{k}) \cdot (\mathbf{i} + \mathbf{j} + 2\mathbf{k}) = \sqrt{6} \sqrt{6} \cos \theta$$

$$\therefore 1 = 6 \cos \theta$$

So $\theta = 80.4^\circ$, correct to one decimal place.

Hence the angle between the line and the plane is $90^\circ - 80.4^\circ = 9.6^\circ$, correct to one decimal place.

Intersection of two planes

Two planes that are not parallel will intersect in a line.



Example 20

Let Π_1 and Π_2 be the planes represented by the vector equations

$$\Pi_1: \mathbf{r} \cdot (\mathbf{i} + \mathbf{j} - 3\mathbf{k}) = 6 \quad \text{and} \quad \Pi_2: \mathbf{r} \cdot (2\mathbf{i} - \mathbf{j} + \mathbf{k}) = 4$$

- Find the angle between the planes.
- Find a vector equation of the line of intersection of the planes.

Solution

- The angle between the planes is equal to the angle between normals to the planes.

A normal to plane Π_1 is $\mathbf{n}_1 = \mathbf{i} + \mathbf{j} - 3\mathbf{k}$, and a normal to plane Π_2 is $\mathbf{n}_2 = 2\mathbf{i} - \mathbf{j} + \mathbf{k}$.

Let θ be the angle between \mathbf{n}_1 and \mathbf{n}_2 . Then

$$\mathbf{n}_1 \cdot \mathbf{n}_2 = |\mathbf{n}_1| |\mathbf{n}_2| \cos \theta$$

$$(\mathbf{i} + \mathbf{j} - 3\mathbf{k}) \cdot (2\mathbf{i} - \mathbf{j} + \mathbf{k}) = \sqrt{11} \sqrt{6} \cos \theta$$

$$\therefore -2 = \sqrt{66} \cos \theta$$

Hence $\theta \approx 104.25^\circ$. The acute angle between the planes is $180^\circ - 104.25^\circ = 75.75^\circ$, correct to two decimal places.

- Consider Cartesian equations for the two planes:

$$x + y - 3z = 6 \quad (1)$$

$$2x - y + z = 4 \quad (2)$$

Add (1) and (2):

$$3x - 2z = 10 \quad (3)$$

Let $x = \lambda$. Then $z = \frac{3\lambda - 10}{2}$, from (3), and $y = \frac{7\lambda - 18}{2}$, from (2).

This gives us parametric equations for the line of intersection:

$$x = \lambda, \quad y = \frac{7\lambda - 18}{2}, \quad z = \frac{3\lambda - 10}{2}$$

These convert to the vector equation

$$\mathbf{r} = -9\mathbf{j} - 5\mathbf{k} + \lambda \left(\mathbf{i} + \frac{7}{2}\mathbf{j} + \frac{3}{2}\mathbf{k} \right), \quad \lambda \in \mathbb{R}$$

Note: Alternatively, we can use the parametric equations to find a point $A(0, -9, -5)$ on the line. A vector \mathbf{d} parallel to the line must be perpendicular to the two normals \mathbf{n}_1 and \mathbf{n}_2 . Hence we can use the vector product:

$$\mathbf{n}_1 \times \mathbf{n}_2 = -2\mathbf{i} - 7\mathbf{j} - 3\mathbf{k}$$

We can choose $\mathbf{d} = 2\mathbf{i} + 7\mathbf{j} + 3\mathbf{k}$, giving $\mathbf{r} = -9\mathbf{j} - 5\mathbf{k} + \lambda(2\mathbf{i} + 7\mathbf{j} + 3\mathbf{k})$, $\lambda \in \mathbb{R}$.

► Distance between two skew lines

Given two skew lines, it can be shown that there is a unique line segment PQ joining the two lines that is perpendicular to both lines. The distance between the two lines is the length PQ .

We can find the distance between a pair of skew lines $\ell_1: \mathbf{r}_1 = \mathbf{a}_1 + \lambda \mathbf{d}_1$ and $\ell_2: \mathbf{r}_2 = \mathbf{a}_2 + \mu \mathbf{d}_2$ as follows.

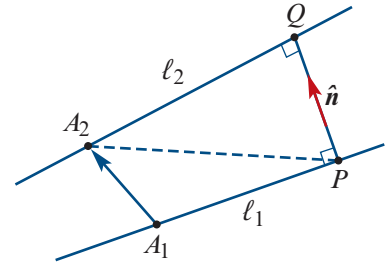

Steps	Explanation
1 Let P and Q be the points on ℓ_1 and ℓ_2 such that PQ is the distance between ℓ_1 and ℓ_2 .	
2 A unit vector parallel to \overrightarrow{PQ} is $\hat{\mathbf{n}} = \frac{\mathbf{d}_1 \times \mathbf{d}_2}{ \mathbf{d}_1 \times \mathbf{d}_2 }$	Vector \overrightarrow{PQ} is perpendicular to both lines and thus parallel to $\mathbf{d}_1 \times \mathbf{d}_2$.
3 The distance between the skew lines is $d = (\mathbf{a}_2 - \mathbf{a}_1) \cdot \hat{\mathbf{n}} $	The magnitude of the projection of $\overrightarrow{PA_2}$ onto $\hat{\mathbf{n}}$ will give the distance, and $\overrightarrow{PA_2} \cdot \hat{\mathbf{n}} = (\overrightarrow{PA_1} + \overrightarrow{A_1A_2}) \cdot \hat{\mathbf{n}} = \overrightarrow{A_1A_2} \cdot \hat{\mathbf{n}}.$

Example 21

Find the distance between the two skew lines

$$\ell_1: \mathbf{r}_1 = \mathbf{i} + \mathbf{j} + \lambda(2\mathbf{i} - \mathbf{j} + \mathbf{k}) \quad \text{and} \quad \ell_2: \mathbf{r}_2 = 2\mathbf{i} + \mathbf{j} - \mathbf{k} + \mu(3\mathbf{i} - 5\mathbf{j} + 2\mathbf{k})$$

Solution

Here we have

$$\begin{aligned} \mathbf{a}_1 &= \mathbf{i} + \mathbf{j} & \mathbf{d}_1 &= 2\mathbf{i} - \mathbf{j} + \mathbf{k} \\ \mathbf{a}_2 &= 2\mathbf{i} + \mathbf{j} - \mathbf{k} & \mathbf{d}_2 &= 3\mathbf{i} - 5\mathbf{j} + 2\mathbf{k} \end{aligned}$$

Step 1 Let P and Q be the points on ℓ_1 and ℓ_2 such that PQ is the distance between ℓ_1 and ℓ_2 .

Step 2 A unit vector parallel to \overrightarrow{PQ} is $\hat{\mathbf{n}} = \frac{\mathbf{d}_1 \times \mathbf{d}_2}{|\mathbf{d}_1 \times \mathbf{d}_2|}$.

Here $\mathbf{d}_1 \times \mathbf{d}_2 = 3\mathbf{i} - \mathbf{j} - 7\mathbf{k}$ and $|\mathbf{d}_1 \times \mathbf{d}_2| = \sqrt{59}$, so

$$\hat{\mathbf{n}} = \frac{1}{\sqrt{59}}(3\mathbf{i} - \mathbf{j} - 7\mathbf{k})$$

Step 3 The distance between the skew lines is $d = |(\mathbf{a}_2 - \mathbf{a}_1) \cdot \hat{\mathbf{n}}|$.

Since $\mathbf{a}_2 - \mathbf{a}_1 = \mathbf{i} - \mathbf{k}$, we have

$$d = |(\mathbf{i} - \mathbf{k}) \cdot \frac{1}{\sqrt{59}}(3\mathbf{i} - \mathbf{j} - 7\mathbf{k})| = \frac{10}{\sqrt{59}}$$

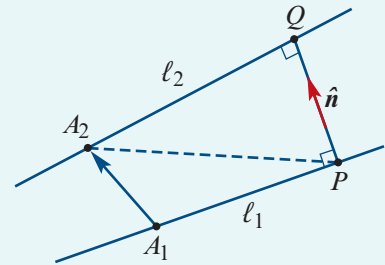

Exercise 6E

Example 17

1 Find the distance from the point $(1, 3, 2)$ to each of the following planes:

a $\mathbf{r} \cdot (7\mathbf{i} + 4\mathbf{j} + 4\mathbf{k}) = 9$

b $6x + 6y + 3z = 8$

Example 18

2 Find the distance between the pair of parallel planes $\Pi_1: x + 2y - 2z = 4$ and $\Pi_2: x + 2y - 2z = 12$.

Example 19

3 Consider the line represented by the equation $\mathbf{r} = 3\mathbf{i} - \mathbf{j} - \mathbf{k} + t(\mathbf{i} + 2\mathbf{j} - 2\mathbf{k})$ and the plane represented by the equation $\mathbf{r} \cdot (\mathbf{i} + \mathbf{j} + 2\mathbf{k}) = 4$.

a Find the point of intersection of the line and the plane.

b Find the angle between the line and the plane.

Example 20

4 Let Π_1 and Π_2 be the planes represented by the vector equations

$$\Pi_1: \mathbf{r} \cdot (2\mathbf{i} + \mathbf{j} - \mathbf{k}) = 8 \quad \text{and} \quad \Pi_2: \mathbf{r} \cdot (\mathbf{i} - \mathbf{j} + 2\mathbf{k}) = 6$$

a Find the angle between the planes.

b Find a vector equation of the line of intersection of the planes.

5 Let $A = (2, 0, -1)$, $B = (1, -3, 1)$, $C = (0, -1, 2)$ and $D = (3, -2, 2)$.

a Find a vector normal to the plane containing points A , B and C .

b Find a vector normal to the plane containing points B , C and D .

c Use the two normal vectors to find the angle between these two planes.

6 In each of the following, a pair of vector equations is given that represent a line and a plane respectively. Find the point of intersection of the line and the plane and find the angle between the line and the plane, correct to two decimal places.

a $\mathbf{r} = \mathbf{i} - 3\mathbf{j} + 2\mathbf{k} + t(\mathbf{i} + \mathbf{j} - 3\mathbf{k})$

b $\mathbf{r} = 3\mathbf{i} - \mathbf{j} - 2\mathbf{k} + t(-\mathbf{i} + \mathbf{j} + \mathbf{k})$

$\mathbf{r} \cdot (2\mathbf{i} - \mathbf{j} - \mathbf{k}) = 7$

$\mathbf{r} \cdot (\mathbf{i} - 4\mathbf{j} + \mathbf{k}) = 7$

c $\mathbf{r} = -\mathbf{i} + 2\mathbf{j} - 4\mathbf{k} + t(3\mathbf{i} - \mathbf{j} + \mathbf{k})$

d $\mathbf{r} = -\mathbf{i} - 5\mathbf{j} + 3\mathbf{k} + t(2\mathbf{i} - 3\mathbf{j} + 2\mathbf{k})$

$\mathbf{r} \cdot (-2\mathbf{i} + \mathbf{j} - \mathbf{k}) = 4$

$\mathbf{r} \cdot (3\mathbf{i} + 2\mathbf{j} - \mathbf{k}) = -10$

7 The vector $\mathbf{i} - 2\mathbf{j} + 6\mathbf{k}$ is normal to a plane Π which contains the point $A(5, 4, -1)$.

a Find a vector equation of the plane.

b Find the distance of the plane from the origin.

8 a Find the distance from the origin to the plane $\mathbf{r} \cdot (2\mathbf{i} - \mathbf{j} - 2\mathbf{k}) = 7$.

b Find the vector projection of $\mathbf{i} + \mathbf{j} - \mathbf{k}$ in the direction of $2\mathbf{i} - \mathbf{j} - 2\mathbf{k}$.

c Find the magnitude of this vector projection.

d Hence find the distance from the point $(1, 1, -1)$ to the given plane.

9 Using the method of Question 8, find the distance from the point $(2, -1, 3)$ to the plane given by the equation $\mathbf{r} \cdot (-\mathbf{i} + 2\mathbf{j} + 2\mathbf{k}) = -3$.

- 10** **a** Find the point of intersection of the line $r = i - j + k + t(2i - k)$ and the plane $r \cdot (3i + 2j + 2k) = 11$.
- b** Find the acute angle between the line and the plane, correct to one decimal place.
- 11** Points A , B and C have position vectors $a = 3i - j + 2k$, $b = 3i - 3j + 4k$ and $c = i - j + 4k$ respectively.
- a** Find a Cartesian equation of the plane containing A , B and C .
- b** Find the area of triangle ABC .
- c** Find the position vector of the foot of the perpendicular from the origin O to the plane ABC .
- 12** Let Π_1 and Π_2 be the planes represented by the vector equations
- $$\Pi_1: r \cdot (3i + 6j - 2k) = 3 \quad \text{and} \quad \Pi_2: r \cdot (8i - 4j + k) = 1$$
- a** Find the angle between the planes.
- b** Find a vector equation of the line of intersection of the planes.
- 13** Let $A = (0, 2, -1)$, $B = (1, 1, 1)$, $C = (-1, 0, 2)$ and $D = (2, -2, 2)$.
- a** Find a vector normal to the plane containing points A , B and C .
- b** Find a vector normal to the plane containing points B , C and D .
- c** Use the two normal vectors to find the angle between these two planes.
- 14** **a** Find a vector which is perpendicular to the two lines given by
- $$r_1 = 2i + j - 2k + t_1(i - j + 2k), \quad t_1 \in \mathbb{R}$$
- $$r_2 = 2i + j - 2k + t_2(-i + 2j + 2k), \quad t_2 \in \mathbb{R}$$
- b** Find a vector equation of the line which is normal to the plane containing these two lines and which passes through their point of intersection.

Example 21 **15** Find the distance between the two skew lines:

$$r_1 = (1 + t)i + (1 + 6t)j + 2tk$$

$$r_2 = (1 + 2s)i + (5 + 15s)j + (-2 + 6s)k$$

16 Find the distance between the two skew lines:

$$r_1 = (1 + t)i + (2 - t)j + (1 + t)k$$

$$r_2 = (2 + 2s)i + (-1 + s)j + (-1 + 2s)k$$

17 Find the distance between the two skew lines:

$$r_1 = (1 - t)i + (t - 2)j + (3 - 2t)k$$

$$r_2 = (1 + s)i + (-1 + 2s)j + (-1 + 2s)k$$



6F Equations of spheres

In three-dimensional space, the **unit sphere** is the sphere with centre the origin and radius 1.

Let $P(x, y, z)$ be a point on the unit sphere. Then $|\vec{OP}| = 1$ and therefore

$$x^2 + y^2 + z^2 = 1$$

Conversely, any point $P(x, y, z)$ which satisfies $x^2 + y^2 + z^2 = 1$ lies on the unit sphere.

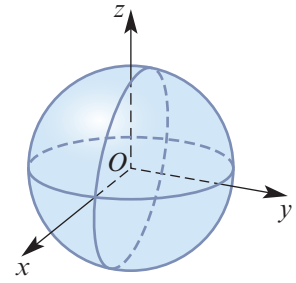

Similarly, we can obtain the general Cartesian equation of a sphere.

Cartesian equation of a sphere

The sphere with centre $C(h, k, \ell)$ and radius a has Cartesian equation

$$(x - h)^2 + (y - k)^2 + (z - \ell)^2 = a^2$$

We note that this again depends on the idea of a set of points which are equidistant from a given point. The vector equation of a sphere is also derived from this observation.

Vector equation of a sphere

The sphere with centre C and radius a has vector equation

$$|\mathbf{r} - \vec{OC}| = a$$

A point P lies on the sphere if and only if its position vector \mathbf{r} satisfies this condition.

Example 22

For the sphere with centre $(1, -2, 3)$ and radius 6, find:

a the Cartesian equation

b the vector equation.

Solution

a $(x - 1)^2 + (y + 2)^2 + (z - 3)^2 = 36$

b $|\mathbf{r} - (\mathbf{i} - 2\mathbf{j} + 3\mathbf{k})| = 6$

Example 23

Find the intersection of the line $\mathbf{r} = t(2\mathbf{i} + \mathbf{j} - 2\mathbf{k})$, $t \in \mathbb{R}$, and the sphere $x^2 + y^2 + z^2 = 9$.

Solution

The line $\mathbf{r} = t(2\mathbf{i} + \mathbf{j} - 2\mathbf{k})$ is described by the parametric equations

$$x = 2t, \quad y = t, \quad z = -2t$$

Substituting in the equation of the sphere gives

$$4t^2 + t^2 + 4t^2 = 9$$

Therefore $t = \pm 1$. The points of intersection are $(2, 1, -2)$ and $(-2, -1, 2)$.

Exercise 6F

Example 22

1 For the sphere with centre $(-1, 3, 2)$ and radius 2, find:

- a** the Cartesian equation
- b** the vector equation.

2 For the sphere with centre $(-1, -3, 1)$ and radius 4, find:

- a** the Cartesian equation
- b** the vector equation.

Example 23

3 Find the intersection of the line $x = 2t$, $y = 3t$, $z = -2t$ and the sphere $x^2 + y^2 + z^2 = 16$.

4 Find the intersection of the line $\mathbf{r} = \mathbf{i} + \mathbf{j} + \mathbf{k} + t(\mathbf{i} + \mathbf{j} - 2\mathbf{k})$, $t \in \mathbb{R}$, and the sphere $x^2 + y^2 + z^2 = 36$.

5 Find the intersection of the line $\mathbf{r} = 2\mathbf{i} + 3\mathbf{j} + 4\mathbf{k} + t(\mathbf{i} + \mathbf{j})$, $t \in \mathbb{R}$, and the sphere $(x - 2)^2 + (y - 3)^2 + (z - 4)^2 = 36$.

6 For each of the following, give the coordinates of the centre and the radius of the circle formed by the given plane cutting the sphere $x^2 + y^2 + z^2 = 36$:

- a** $z = 3$
- b** $x = 3$
- c** $y = x$

7 The equation of a sphere is

$$x^2 + y^2 + z^2 - 2x - 4y + 8z + 17 = 0$$

Find the coordinates of the centre and the radius of the sphere.

8 Find the Cartesian equation of each of the following spheres:

- a** centre $(1, 0, -1)$ and radius 4
- b** centre $(1, -3, 2)$ and passes through the origin
- c** centre $(3, -2, 4)$ and passes through $(7, 2, 3)$
- d** centre the origin and passes through $(1, 2, 2)$

9 The equation of a sphere is $(x - 2)^2 + (y - 3)^2 + (z - 4)^2 = 29$.

- a** Find the intercepts with each of the axes.
- b** Find a vector equation of the line which passes through the centre of the sphere and the point $X(4, 0, 0)$.
- c** Find a Cartesian equation of the plane which contains the point $X(4, 0, 0)$ and is perpendicular to the radius joining the centre of the sphere to X .



Chapter summary



Lines A line in three dimensions can be described as follows, where $\mathbf{a} = a_1\mathbf{i} + a_2\mathbf{j} + a_3\mathbf{k}$ is the position vector of a point A on the line, and $\mathbf{d} = d_1\mathbf{i} + d_2\mathbf{j} + d_3\mathbf{k}$ is parallel to the line.

Vector equation	Parametric equations	Cartesian form
$\mathbf{r} = \mathbf{a} + t\mathbf{d}, \quad t \in \mathbb{R}$	$x = a_1 + d_1t$ $y = a_2 + d_2t$ $z = a_3 + d_3t$	$\frac{x - a_1}{d_1} = \frac{y - a_2}{d_2} = \frac{z - a_3}{d_3}$

Planes A plane in three dimensions can be described as follows, where \mathbf{a} is the position vector of a point A on the plane, $\mathbf{n} = n_1\mathbf{i} + n_2\mathbf{j} + n_3\mathbf{k}$ is normal to the plane, and $k = \mathbf{a} \cdot \mathbf{n}$.

Vector equation	Cartesian equation
$\mathbf{r} \cdot \mathbf{n} = \mathbf{a} \cdot \mathbf{n}$	$n_1x + n_2y + n_3z = k$

Spheres A sphere in three dimensions can be described as follows, where $\mathbf{c} = c_1\mathbf{i} + c_2\mathbf{j} + c_3\mathbf{k}$ is the position vector of the centre C , and a is the radius.

Vector equation	Cartesian equation
$ \mathbf{r} - \mathbf{c} = a$	$(x - c_1)^2 + (y - c_2)^2 + (z - c_3)^2 = a^2$

Vector product

- If $\mathbf{a} = a_1\mathbf{i} + a_2\mathbf{j} + a_3\mathbf{k}$ and $\mathbf{b} = b_1\mathbf{i} + b_2\mathbf{j} + b_3\mathbf{k}$, then

$$\mathbf{a} \times \mathbf{b} = (a_2b_3 - a_3b_2)\mathbf{i} - (a_1b_3 - a_3b_1)\mathbf{j} + (a_1b_2 - a_2b_1)\mathbf{k}$$
- The magnitude of $\mathbf{a} \times \mathbf{b}$ is equal to $|\mathbf{a}||\mathbf{b}|\sin\theta$, where θ is the angle between \mathbf{a} and \mathbf{b} .
- The direction of $\mathbf{a} \times \mathbf{b}$ is perpendicular to both \mathbf{a} and \mathbf{b} (provided \mathbf{a} and \mathbf{b} are non-zero vectors and not parallel).

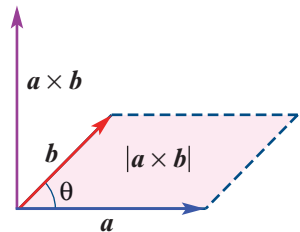

Distances and angles

- **Distance from a point to a line** The distance from a point P to a line ℓ is given by $|\overrightarrow{PQ}|$, where Q is the point on the line such that PQ is perpendicular to the line.
- **Distance from a point to a plane** The distance from a point P to a plane Π is given by $|\overrightarrow{PQ} \cdot \hat{\mathbf{n}}|$, where $\hat{\mathbf{n}}$ is a unit vector normal to the plane and Q is any point on the plane.
- **Angle between two lines** First find the angle θ between two vectors \mathbf{d}_1 and \mathbf{d}_2 that are parallel to the two lines. The angle between the lines is θ or $180^\circ - \theta$, whichever is in the interval $[0^\circ, 90^\circ]$.
- **Angle between two planes** First find the angle θ between two vectors \mathbf{n}_1 and \mathbf{n}_2 that are normal to the two planes. The angle between the planes is θ or $180^\circ - \theta$, whichever is in the interval $[0^\circ, 90^\circ]$.
- **Angle between a line and a plane** The angle between a line ℓ and a plane Π is $90^\circ - \theta$, where θ is the angle between the line and a normal to the plane.

Short-answer questions

- 1 Find the position vector of the point of intersection of the lines $r_1 = i + j - k + \lambda(3i - j)$ and $r_2 = 4i - k + \mu(2i + 3k)$.
- 2 Show that the lines $r_1 = i - j + \lambda(2i + k)$ and $r_2 = 2i - j + \mu(i + j - k)$ do not intersect.
- 3 Find a Cartesian equation of the plane through the point $(1, 2, 3)$ with normal vector $4i + 5j + 6k$.
- 4 Find a vector equation of the line parallel to the x -axis that contains the point $(-2, 2, 1)$.
- 5 Find the coordinates of the nearest point to $(2, 1, 3)$ on the line $r = i + 2j + t(i - j + 2k)$.
- 6 Find the distance from the origin to the line passing through the point $(3, 1, 5)$ parallel to the vector $2i - j + k$.
- 7 Find the coordinates of the point of intersection of the line $r = i + k + t(2i + j - 3k)$, $t \in \mathbb{R}$, and the plane $r \cdot (i - 2j + 3k) = 13$.
- 8 Find a vector that is perpendicular to the vectors $8i - 3j + k$ and $7i - 2j$.
- 9 The line ℓ passes through the points $A(-1, -3, -3)$ and $B(5, 0, 6)$. Find a vector equation of the line ℓ . Find the point P on the line ℓ such that OP is perpendicular to the line, where O is the origin.
- 10 Show that the lines $r_1 = 3i + 4j + k + \lambda(2i - j + k)$ and $r_2 = i + 5j + 7k + \mu(i + k)$ are skew lines. Find the cosine of the angle between the lines.
- 11 Determine a Cartesian equation of the plane that contains the points $P(1, -2, 0)$, $Q(3, 1, 4)$ and $R(0, -1, 2)$.
- 12 Determine a Cartesian equation of the plane that contains the points $P(1, -2, 1)$, $Q(-2, 5, 0)$ and $R(-4, 3, 2)$.
- 13 Find an equation of the plane through $A(-1, 2, 0)$, $B(3, 1, 1)$ and $C(1, 0, 3)$ in:
 - a vector form
 - b Cartesian form.
- 14
 - a Find a Cartesian equation of the plane passing through the origin O and the points $A(1, 1, 1)$ and $B(0, 1, 2)$.
 - b Find the area of triangle OAB .
 - c Show that the point $C(-2, 2, 6)$ lies on the plane and find the point of intersection of the lines OB and AC .
- 15 The origin O and the point $A(2, -1, -1)$ are two vertices of an equilateral triangle OAB in the plane $x + y + z = 0$. Find the coordinates of the vertex B .
- 16 Show that the four points $(1, 0, 0)$, $(2, 1, 0)$, $(3, 2, 1)$ and $(4, 3, 2)$ are coplanar.
- 17 For vectors a , b and c such that $a + b + c = \mathbf{0}$, show that $a \times b = b \times c = c \times a$.



Multiple-choice questions



- 1 The three vertices of a triangle have position vectors \mathbf{a} , \mathbf{b} and \mathbf{c} . The area of the triangle is equal to
- A $\mathbf{a} \times \mathbf{b}$ B $\frac{1}{2}|\mathbf{b} \times \mathbf{c}|$ C $\frac{1}{2}|(\mathbf{a} - \mathbf{b}) \times (\mathbf{b} - \mathbf{c})|$
D $(\mathbf{b} - \mathbf{c}) \times (\mathbf{a} - \mathbf{b})$ E $|(\mathbf{c} - \mathbf{a}) \times (\mathbf{a} - \mathbf{b})|$
- 2 A plane has equation $\mathbf{r} \cdot (\mathbf{i} + \mathbf{j} - 2\mathbf{k}) = 5$. The distance from the origin to this plane is
- A 5 B $\frac{5}{4}$ C $\frac{5}{6}$ D $\frac{5}{\sqrt{6}}$ E $\sqrt{5}$
- 3 Which of the following is a Cartesian equation of the plane that has axis intercepts at $x = 1$, $y = 2$ and $z = 3$?
- A $x + 2y + 3z = 0$ B $x + 2y + 3z = 1$ C $x + 2y + 3z = 6$
D $6x + 3y + 2z = 6$ E $6x + 3y + 2z = 0$
- 4 The line given by $\mathbf{r} = 5\mathbf{i} - 3\mathbf{j} + \mathbf{k} + \lambda(2\mathbf{i} - 2\mathbf{j} - \mathbf{k})$, $\lambda \in \mathbb{R}$, intersects the plane given by $\mathbf{r} \cdot (2\mathbf{i} + \mathbf{j} - 3\mathbf{k}) = -6$ at the point with position vector
- A $2\mathbf{i} + \mathbf{j} - 3\mathbf{k}$ B $5\mathbf{i} - 7\mathbf{j} - 3\mathbf{k}$ C $3\mathbf{i} - 5\mathbf{j}$ D $\mathbf{i} + \mathbf{j} + 3\mathbf{k}$ E $5\mathbf{i} - 4\mathbf{j} - 3\mathbf{k}$
- 5 The distance from the point $P(1, 5)$ to the line that passes through $(0, 0)$ and $(1, 1)$ is
- A 1 B $\sqrt{2}$ C 2 D $2\sqrt{2}$ E 3
- 6 Which of the following vector equations does *not* describe the line passing through the points $(2, 0, 1)$ and $(3, 3, 3)$?
- A $\mathbf{r} = (2 + t)\mathbf{i} + 3t\mathbf{j} + (1 + 2t)\mathbf{k}$ B $\mathbf{r} = (3 - t)\mathbf{i} + (3 - 3t)\mathbf{j} + (3 - 2t)\mathbf{k}$
C $\mathbf{r} = (2 + 3t)\mathbf{i} + 3t\mathbf{j} + (1 + 3t)\mathbf{k}$ D $\mathbf{r} = (1 + t)\mathbf{i} + (-3 + 3t)\mathbf{j} + (-1 + 2t)\mathbf{k}$
E $\mathbf{r} = (2 + 2t)\mathbf{i} + 6t\mathbf{j} + (1 + 4t)\mathbf{k}$
- 7 Which of the following equations describes the plane that contains the points $(0, 0, 1)$, $(1, 1, 1)$ and $(2, 0, 0)$?
- A $x - y + 2z = 2$ B $x - y + z = 1$ C $x + 3y - z = 4$
D $x - y = 0$ E $x + y + z = 3$
- 8 Which of the following vectors is parallel to the line of intersection of the planes $2x + y + z = 6$ and $x + z = 0$?
- A $2\mathbf{i} + \mathbf{j} + \mathbf{k}$ B $\mathbf{i} + \mathbf{k}$ C $3\mathbf{i} + \mathbf{j} + 2\mathbf{k}$
D $-3\mathbf{i} + 3\mathbf{j} + 3\mathbf{k}$ E $6\mathbf{i} + 2\mathbf{j} + \mathbf{k}$
- 9 The distance from the origin to the plane $x + 2y + 2z = 5$ is
- A 0 B $\frac{1}{5}$ C $\frac{1}{3}$ D 1 E $\frac{5}{3}$
- 10 The triangle with vertices $(0, 0, 1)$, $(1, 1, 1)$ and $(2, 3, 2)$ has area
- A $\frac{1}{5}$ B $\frac{\sqrt{2}}{2}$ C $\frac{\sqrt{3}}{2}$ D 1 E $\sqrt{2}$



Extended-response questions

- 1** Two lines are represented by vector equations $\mathbf{r}_1 = \mathbf{i} + \mathbf{j} - 2\mathbf{k} + t_1(\mathbf{i} - \mathbf{j} + 2\mathbf{k})$, $t_1 \in \mathbb{R}$, and $\mathbf{r}_2 = 2\mathbf{i} + \mathbf{j} + 4\mathbf{k} + t_2(-\mathbf{i} + 2\mathbf{j} + 2\mathbf{k})$, $t_2 \in \mathbb{R}$.

- a** Show that these lines intersect and find their point of intersection, P .
b The vector equation $\mathbf{r}_3 = t_3(\mathbf{i} - \mathbf{j} + 2\mathbf{k})$, $t_3 \in \mathbb{R}$, represents a line through the origin. Find the distance from the point of intersection P to this line.

- 2** The points A , B and C have position vectors $\vec{OA} = 5\mathbf{i} + 3\mathbf{j} + \mathbf{k}$, $\vec{OB} = -\mathbf{i} + \mathbf{j} + 3\mathbf{k}$ and $\vec{OC} = 3\mathbf{i} + 4\mathbf{j} + 7\mathbf{k}$. The plane Π_1 has vector equation $\mathbf{r} \cdot (3\mathbf{i} + \mathbf{j} - \mathbf{k}) = 6$.

- a** Show that the point C is on the plane Π_1 .
b Show that the point B is the reflection in the plane Π_1 of the point A .
c Find the length of the projection of \vec{AC} onto the plane Π_1 .

The plane Π_2 has Cartesian equation $12x - 4y + 3z = k$, where k is a positive constant.

- d** Find the acute angle between planes Π_1 and Π_2 .
e Given that the distance from the point C to the plane Π_2 is 3, find the value of k .
- 3** Consider the two lines given by

$$\ell_1: \quad \mathbf{r}_1 = 3\mathbf{i} + 2\mathbf{j} + \mathbf{k} + t(5\mathbf{i} + 4\mathbf{j} + 3\mathbf{k}), \quad t \in \mathbb{R}$$

$$\ell_2: \quad \mathbf{r}_2 = 16\mathbf{i} - 10\mathbf{j} + 2\mathbf{k} + s(3\mathbf{i} + 2\mathbf{j} - \mathbf{k}), \quad s \in \mathbb{R}$$

- a** Show that ℓ_1 and ℓ_2 are skew lines.
b Verify that both ℓ_1 and ℓ_2 are perpendicular to the vector $\mathbf{n} = 5\mathbf{i} - 7\mathbf{j} + \mathbf{k}$.
c The point $A(3, 2, 1)$ lies on line ℓ_1 . Write down a vector equation of the line ℓ_3 through A in the direction of \mathbf{n} .
d Find the point of intersection, B , of the lines ℓ_2 and ℓ_3 , and find the length of the line segment AB .

- 4** The point O is the origin and the points A , B , C and D have position vectors

$$\vec{OA} = 4\mathbf{i} + 3\mathbf{j} + 4\mathbf{k}, \quad \vec{OB} = 6\mathbf{i} + \mathbf{j} + 2\mathbf{k}, \quad \vec{OC} = 9\mathbf{j} - 6\mathbf{k}, \quad \vec{OD} = -\mathbf{i} + \mathbf{j} + \mathbf{k}$$

Prove that:

- a** the triangle OAB is isosceles
b the point D lies in the plane OAB
c the line CD is perpendicular to the plane OAB
d the line AC is inclined at an angle of 60° to the plane OAB .
- 5** A Cartesian equation of the plane Π_1 is $y + z = 0$ and a vector equation of the line ℓ is $\mathbf{r} = 5\mathbf{i} + 2\mathbf{j} + 2\mathbf{k} + t(2\mathbf{i} - \mathbf{j} + 3\mathbf{k})$, where $t \in \mathbb{R}$. Find:
- a** the position vector of the point of intersection of the line ℓ and the plane Π_1
b the length of the perpendicular from the origin to the line ℓ
c a Cartesian equation of the plane Π_2 which contains the line ℓ and the origin
d the acute angle between the planes Π_1 and Π_2 , correct to one decimal place.



7

Systems of linear equations

Objectives

- ▶ To recognise the general form of a **system of linear equations** in several variables.
- ▶ To investigate the three cases for a system of linear equations:
 - ▶ no solutions
 - ▶ a unique solution
 - ▶ infinitely many solutions.
- ▶ To solve a system of linear equations using **elimination**.
- ▶ To represent a system of linear equations as an **augmented matrix**.
- ▶ To give a geometric interpretation of the solution of a system of linear equations in two variables using lines in two-dimensional space.
- ▶ To give a geometric interpretation of the solution of a system of linear equations in three variables using planes in three-dimensional space.

From the previous chapter, we know that:

- a line in two-dimensional space has a Cartesian equation of the form $ax + by = c$
- a plane in three-dimensional space has a Cartesian equation of the form $ax + by + cz = d$.

These are both called linear equations, since the power of each variable is 1.

In this chapter, we consider systems of simultaneous linear equations such as

$$\begin{array}{ll}
 a_1x + b_1y = c_1 & a_1x + b_1y + c_1z = d_1 \\
 a_2x + b_2y = c_2 & a_2x + b_2y + c_2z = d_2 \\
 & a_3x + b_3y + c_3z = d_3
 \end{array}$$

The system on the left represents two lines, and the system on the right represents three planes. We will look at methods for solving such systems of equations, and the geometric interpretation of the solutions.

Systems of linear equations have important applications in many different fields, including economics, biology and physics.

7A Simultaneous linear equations with two variables

In the plane, two distinct straight lines are either parallel or meet at a point.



There are three cases for a system of two linear equations in two variables.

	Example	Solutions	Geometry
Case 1	$2x + y = 5$ $x - y = 4$	Unique solution: $x = 3, y = -1$	Two lines meeting at a point
Case 2	$2x + y = 5$ $2x + y = 7$	No solutions	Distinct parallel lines
Case 3	$2x + y = 5$ $4x + 2y = 10$	Infinitely many solutions	Two copies of the same line

Example 1

Explain why the simultaneous equations $2x + 3y = 6$ and $4x + 6y = 24$ have no solution.

Solution

First write the two equations in the form $y = mx + c$. They become

$$y = -\frac{2}{3}x + 2 \quad \text{and} \quad y = -\frac{2}{3}x + 4$$

Both lines have gradient $-\frac{2}{3}$. The y -axis intercepts are 2 and 4 respectively.

The equations have no solution as they correspond to distinct parallel lines.

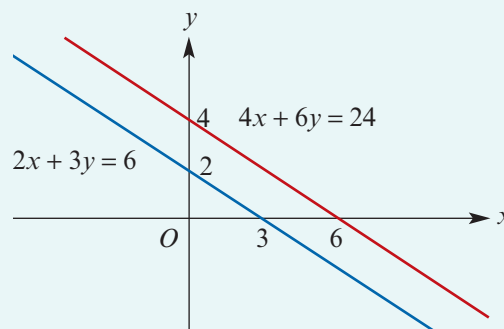

Example 2

The simultaneous equations $2x + 3y = 6$ and $4x + 6y = 12$ have infinitely many solutions. Describe these solutions through the use of a parameter.

Solution

The two lines coincide, and so the solutions are all points on this line.

We make use of a third variable λ as the parameter. If $y = \lambda$, then $x = \frac{6 - 3\lambda}{2}$.

We can write the solutions as $x = \frac{6 - 3\lambda}{2}$ and $y = \lambda$, for $\lambda \in \mathbb{R}$. (This gives a parametric description of the line.)

Using the TI-Nspire

Simultaneous equations can be solved in a **Calculator** application.

- Use **menu** > **Algebra** > **Solve System of Equations** > **Solve System of Equations**.
- Complete the pop-up screen.

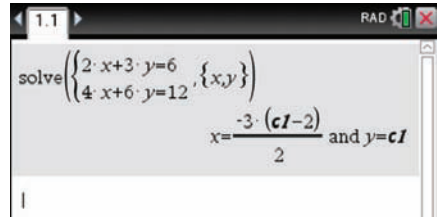

The solution to this system of equations is given by the calculator as shown. The variable cI takes the place of λ .

Using the Casio ClassPad

To solve the simultaneous equations $2x + 3y = 6$ and $4x + 6y = 12$:

- Open the **Math1** keyboard.
- Select the simultaneous equations icon .
- Enter the two equations into the two lines and type x, y in the bottom-right square to indicate the variables. Select **EXE**.

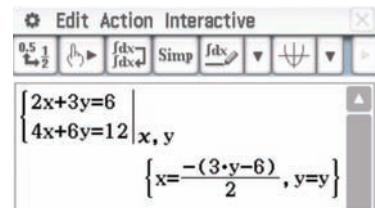

Choose $y = \lambda$ to obtain the solution $x = \frac{6 - 3\lambda}{2}$, $y = \lambda$ where λ is any real number.

Example 3

Consider the simultaneous linear equations $(m - 2)x + y = 2$ and $mx + 2y = k$.

Find the values of m and k such that the system of equations has:

- a** a unique solution **b** no solution **c** infinitely many solutions.

Solution

$$(m - 2)x + y = 2 \quad (1)$$

$$mx + 2y = k \quad (2)$$

Multiply equation (1) by 2 and subtract from equation (2):

$$(m - 2(m - 2))x = k - 4$$

$$\therefore x = \frac{4 - k}{m - 4} \quad (\text{for } m \neq 4)$$

Substitute in (1):

$$\begin{aligned} y &= 2 - (m - 2)x \\ &= 2 - (m - 2) \frac{4 - k}{m - 4} \\ &= \frac{k(m - 2) - 2m}{m - 4} \end{aligned}$$

For $m \neq 4$, we obtain the solution

$$x = \frac{4 - k}{m - 4} \quad \text{and} \quad y = \frac{k(m - 2) - 2m}{m - 4}$$

a There is a unique solution if $m \neq 4$ and k is any real number.

b If $m = 4$, the equations become

$$2x + y = 2 \quad \text{and} \quad 4x + 2y = k$$

There is no solution if $m = 4$ and $k \neq 4$.

c If $m = 4$ and $k = 4$, there are infinitely many solutions as the equations are the same.

Exercise 7A

1 Solve each of the following pairs of simultaneous linear equations:

a $3x + 2y = 6$	b $2x + 6y = 0$	c $4x - 2y = 7$	d $2x - y = 6$
$x - y = 7$	$y - x = 2$	$5x + 7y = 1$	$4x - 7y = 5$

2 For each of the following, state whether the simultaneous equations have no solution, one solution or infinitely many solutions:

a $3x + 2y = 6$	b $x + 2y = 6$	c $x - 2y = 3$
$3x - 2y = 12$	$2x + 4y = 12$	$2x - 4y = 12$

Example 1

3 Explain why the simultaneous equations $2x + 3y = 6$ and $4x + 6y = 10$ have no solution.

Example 2

4 The simultaneous equations $x - y = 6$ and $2x - 2y = 12$ have infinitely many solutions. Describe these solutions through the use of a parameter.

Example 3

5 Find the value of m for which the simultaneous equations

$$\begin{aligned} 3x + my &= 5 \\ (m + 2)x + 5y &= m \end{aligned}$$

a have infinitely many solutions **b** have no solution.

6 Find the value of m for which the following simultaneous equations have no solution:

$$\begin{aligned} (m + 3)x + my &= 12 \\ (m - 1)x + (m - 3)y &= 7 \end{aligned}$$

7 Consider the simultaneous equations $mx + 2y = 8$ and $4x - (2 - m)y = 2m$.

a Find the values of m for which there are:

i no solutions **ii** infinitely many solutions.

b Solve the equations in terms of m , for suitable values of m .

8 a Solve the simultaneous equations $2x - 3y = 4$ and $x + ky = 2$, where k is a constant.

b Find the value of k for which there is not a unique solution.

- 9 Find the values of b and c for which the equations $x + 5y = 4$ and $2x + by = c$ have:
- a** a unique solution **b** an infinite set of solutions **c** no solution.
- 10 For each of the following systems of equations:
- i** Find the values of $b \in \mathbb{R}$ for which there is a unique solution.
ii Find the values of $b \in \mathbb{R}$ for which there are infinitely many solutions.
iii Find the values of $b \in \mathbb{R}$ for which there are no solutions.
iv In the cases where solutions exist, express the solutions in terms of b .



a $x + y = 4$
 $2x + 2y = b$

b $x + y = 4$
 $2x + y = b$

c $x + y = 4$
 $bx + y = 8$

7B Simultaneous linear equations with more than two variables

► Linear equations in three variables

Consider the general system of three linear equations in three variables:

$$a_1x + b_1y + c_1z = d_1$$

$$a_2x + b_2y + c_2z = d_2$$

$$a_3x + b_3y + c_3z = d_3$$

In this section and the next, we look at how to solve such systems of simultaneous equations. In some cases, this can be done easily by elimination, as shown in Examples 4 and 5. Other cases require a more systematic method, which is introduced in the next section.

Example 4

Solve the following system of three equations in three variables:

$$2x + y + z = -1 \quad (1)$$

$$3y + 4z = -7 \quad (2)$$

$$6x + z = 8 \quad (3)$$

Solution

Subtract (1) from (3):

$$4x - y = 9 \quad (4)$$

Subtract (2) from $4 \times (3)$:

$$24x - 3y = 39$$

$$8x - y = 13 \quad (5)$$

Subtract (4) from (5) to obtain $4x = 4$. Hence $x = 1$.

Substitute in (4) to find $y = -5$, and substitute in (3) to find $z = 2$.

Explanation

The aim is first to eliminate z and obtain two simultaneous equations in x and y only.

Having obtained equations (4) and (5), we solve for x and y . Then substitute to find z .

It should be noted that, just as for two linear equations in two variables, there is a geometric interpretation for three linear equations in three variables. There is only a unique solution if the three equations represent three planes intersecting at a point.

Example 5

Solve the following simultaneous linear equations for x , y and z :

$$x - y + z = 6, \quad 2x + z = 4, \quad 3x + 2y - z = 6$$

Solution

$$x - y + z = 6 \quad (1)$$

$$2x + z = 4 \quad (2)$$

$$3x + 2y - z = 6 \quad (3)$$

Eliminate z to find two simultaneous equations in x and y :

$$x + y = -2 \quad (4) \quad \text{subtracted (1) from (2)}$$

$$5x + 2y = 10 \quad (5) \quad \text{added (2) to (3)}$$

$$\text{Solve to find } x = \frac{14}{3}, \quad y = -\frac{20}{3}, \quad z = -\frac{16}{3}.$$

A CAS calculator can be used to solve a system of three equations in the same way as for solving two simultaneous equations.

Using the TI-Nspire

Use the simultaneous equations template (**menu** > **Algebra** > **Solve System of Equations** > **Solve System of Equations**) as shown.

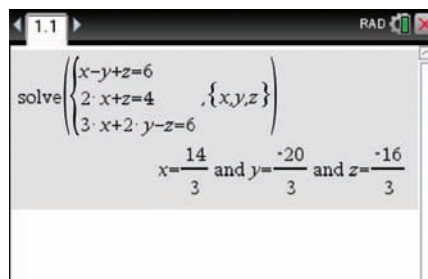
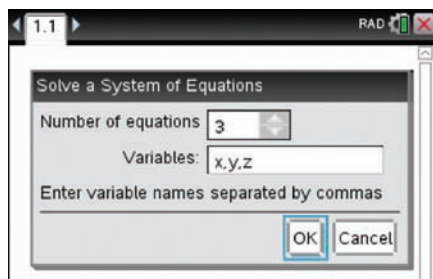

Using the Casio ClassPad

- From the **Math1** keyboard, tap **{}** twice to create a template for three simultaneous equations.
- Enter the equations using the **Var** keyboard.

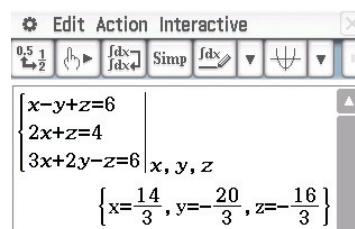

► Geometric interpretation of linear equations in three variables

We have seen in Chapter 6 that an equation of the form

$$ax + by + cz = d$$

defines a plane in three-dimensional space (provided a , b and c are not all zero).

The solution of a system of three linear equations in three variables can correspond to:

- a point
- a line
- a plane.

There also may be no solution. The situations are as shown in the following diagrams.

Examples 4 and 5 provide examples of three planes intersecting at a point (Diagram 1).

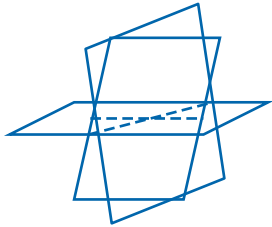

Diagram 1:
Intersection at a point

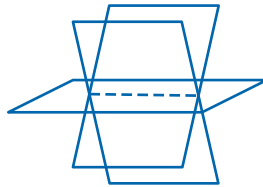

Diagram 2:
Intersection in a line

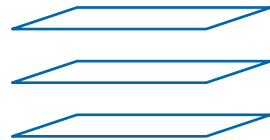

Diagram 3:
No intersection

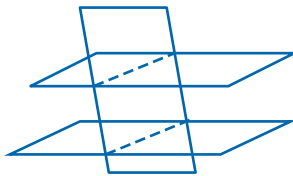

Diagram 4:
No common intersection

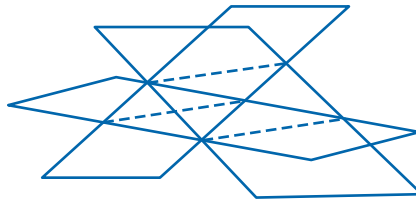

Diagram 5:
No common intersection

Example 6

The simultaneous equations $x + 2y + 3z = 13$, $-x - 3y + 2z = 2$ and $-x - 4y + 7z = 17$ have infinitely many solutions.

- Describe these solutions through the use of a parameter. (Use a CAS calculator.)
- Give a geometric interpretation of the solution.

Solution

- We can use a CAS calculator to find all the solutions in terms of a parameter λ .

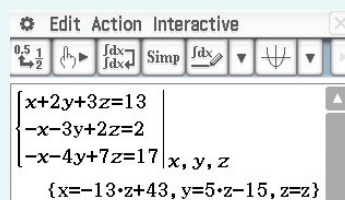
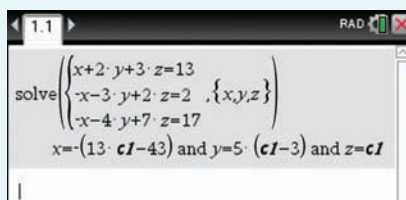

The solutions are given by $x = 43 - 13\lambda$, $y = 5\lambda - 15$ and $z = \lambda$, for $\lambda \in \mathbb{R}$.

b The system of equations represents three planes that intersect along a line. (This is the situation shown in Diagram 2.)

The line of intersection has parametric equations $x = 43 - 13\lambda$, $y = 5\lambda - 15$, $z = \lambda$.

A vector equation of this line is $\mathbf{r} = 43\mathbf{i} - 15\mathbf{j} + \lambda(-13\mathbf{i} + 5\mathbf{j} + \mathbf{k})$, $\lambda \in \mathbb{R}$.

We will investigate the geometric interpretation of systems of linear equations further in the next section.

► Linear equations in more than three variables

In general, we can consider a system of m linear equations in n variables:

$$\begin{array}{ccccccc} a_{11}x_1 + a_{12}x_2 + \cdots + a_{1n}x_n & = & b_1 \\ a_{21}x_1 + a_{22}x_2 + \cdots + a_{2n}x_n & = & b_2 \\ \vdots & & \vdots & \ddots & \vdots & & \vdots \\ a_{m1}x_1 + a_{m2}x_2 + \cdots + a_{mn}x_n & = & b_m \end{array}$$

Such a system of equations has a geometric interpretation involving the intersection of ‘hyperplanes’ in n -dimensional space.

A system of linear equations in several variables can be solved using a CAS calculator or using the method introduced in the next section. Applications of linear equations in economics and biology can involve hundreds or even thousands of variables.

Exercise 7B

Example 4, 5

1 Solve each of the following systems of simultaneous equations:

a $2x + 3y - z = 12$
 $2y + z = 7$
 $2y - z = 5$

b $x + 2y + 3z = 13$
 $-x - y + 2z = 2$
 $-x + 3y + 4z = 26$

c $x + y = 5$
 $y + z = 7$
 $z + x = 12$

d $x - y - z = 0$
 $5x + 20z = 50$
 $10y - 20z = 30$

Example 6

2 Consider the simultaneous equations $x + 2y - 3z = 4$ and $x + y + z = 6$.

- a** Subtract the second equation from the first to find y in terms of z .
b Let $z = \lambda$. Solve the equations to give the solution in terms of λ .

3 Solve each of the following pairs of simultaneous equations, giving your answer in terms of a parameter λ . Use the technique introduced in Question 2.

a $x - y + z = 4$
 $-x + y + z = 6$

b $2x - y + z = 6$
 $x - z = 3$

c $4x - 2y + z = 6$
 $x + y + z = 4$

4 Consider the simultaneous equations

$$x + 2y + 3z = 13 \quad (1)$$

$$-x - 3y + 2z = 2 \quad (2)$$

$$-x - 4y + 7z = 17 \quad (3)$$

- a** Add equation (2) to equation (1) and subtract equation (2) from equation (3).
b Comment on the equations obtained in part **a**.
c Let $z = \lambda$ and find y in terms of λ .
d Substitute for z and y in terms of λ in equation (1) to find x in terms of λ .

5 The system of equations

$$x + y + z + w = 4$$

$$x + 3y + 3z = 2$$

$$x + y + 2z - w = 6$$

has infinitely many solutions. Describe this family of solutions and give the unique solution when $w = 6$.

6 Find all solutions for each of the following systems of equations:

a $3x - y + z = 4$

b $x - y - z = 0$

c $2x - y + z = 0$

$x + 2y - z = 2$

$3y + 3z = -5$

$y + 2z = 2$

$-x + y - z = -2$



7C Using augmented matrices for systems of equations

We now introduce a more systematic method for solving simultaneous equations. We focus on the case where there are three variables, but the method applies in general.

We can represent a system of linear equations by what is called an **augmented matrix**. Here is an example of an augmented matrix and the corresponding system of equations:

$$\left[\begin{array}{ccc|c} 1 & 1 & 2 & 9 \\ 2 & 4 & -3 & 1 \\ 3 & 6 & -5 & 0 \end{array} \right] \quad \begin{array}{l} x + y + 2z = 9 \\ 2x + 4y - 3z = 1 \\ 3x + 6y - 5z = 0 \end{array}$$

Our aim is to form a new system of equations that is equivalent to this system but has a simpler form, so that we can easily ‘read off’ the solutions.

We are allowed to use the following operations on the augmented matrix.

Elementary row operations

- Interchange two rows.
- Multiply a row by a non-zero number.
- Add a multiple of one row to another row.

We apply the elementary row operations to form a new augmented matrix such that all the entries below the main diagonal (top left to bottom right) are **zero**.

Step 1 Form the augmented matrix for the original equations:

$$\left[\begin{array}{ccc|c} 1 & 1 & 2 & 9 \\ 2 & 4 & -3 & 1 \\ 3 & 6 & -5 & 0 \end{array} \right] \quad \begin{array}{l} x + y + 2z = 9 \\ 2x + 4y - 3z = 1 \\ 3x + 6y - 5z = 0 \end{array}$$

Step 2 Subtract $2 \times$ row 1 from row 2:

$$\left[\begin{array}{ccc|c} 1 & 1 & 2 & 9 \\ 0 & 2 & -7 & -17 \\ 3 & 6 & -5 & 0 \end{array} \right] \quad R'_2 = R_2 - 2 \times R_1 \quad \begin{array}{l} x + y + 2z = 9 \\ 2y - 7z = -17 \\ 3x + 6y - 5z = 0 \end{array}$$

Step 3 Subtract $3 \times$ row 1 from row 3:

$$\left[\begin{array}{ccc|c} 1 & 1 & 2 & 9 \\ 0 & 2 & -7 & -17 \\ 0 & 3 & -11 & -27 \end{array} \right] \quad R'_3 = R_3 - 3 \times R_1 \quad \begin{array}{l} x + y + 2z = 9 \\ 2y - 7z = -17 \\ 3y - 11z = -27 \end{array}$$

Step 4 Multiply row 2 by 3 and multiply row 3 by 2:

$$\left[\begin{array}{ccc|c} 1 & 1 & 2 & 9 \\ 0 & 6 & -21 & -51 \\ 0 & 6 & -22 & -54 \end{array} \right] \quad \begin{array}{l} R'_2 = 3 \times R_2 \\ R'_3 = 2 \times R_3 \end{array} \quad \begin{array}{l} x + y + 2z = 9 \\ 6y - 21z = -51 \\ 6y - 22z = -54 \end{array}$$

Step 5 Subtract row 2 from row 3:

$$\left[\begin{array}{ccc|c} 1 & 1 & 2 & 9 \\ 0 & 6 & -21 & -51 \\ 0 & 0 & -1 & -3 \end{array} \right] \quad R'_3 = R_3 - R_2 \quad \begin{array}{l} x + y + 2z = 9 \quad (1) \\ 6y - 21z = -51 \quad (2) \\ -z = -3 \quad (3) \end{array}$$

We can now find the solution: $z = 3$ from equation (3), so $y = 2$ from (2) and $x = 1$ from (1).

Row-echelon form

The first non-zero entry of a row is called the **row leader**. In our final augmented matrix, the row leaders are 1, 6 and -1 .

This augmented matrix is said to be in **row-echelon form**: each successive row leader is further to the right, and so each row leader has only 0s below.

$$\left[\begin{array}{ccc|c} 1 & 1 & 2 & 9 \\ 0 & 6 & -21 & -51 \\ 0 & 0 & -1 & -3 \end{array} \right]$$

If we continue with elementary row operations, we can obtain an even simpler form:

$$\left[\begin{array}{ccc|c} 1 & 0 & 0 & 1 \\ 0 & 1 & 0 & 2 \\ 0 & 0 & 1 & 3 \end{array} \right] \quad \begin{array}{l} x = 1 \\ y = 2 \\ z = 3 \end{array}$$

This augmented matrix is in **reduced row-echelon form**: each successive row leader is further to the right, each row leader is 1, and each row leader has only 0s above and below.

Using row operations on augmented matrices provides us with a technique for solving simultaneous linear equations that can be applied in all cases. We illustrate the method by investigating some different cases for a system of three equations in three variables.

Three planes intersecting at a point



Example 7

The simultaneous equations $x + 2z = 6$, $-3x + 4y + 6z = 30$ and $-x - 2y + 3z = 8$ have a unique solution.

- Find this solution.
- Give a geometric interpretation of the solution.

Solution

We will obtain an augmented matrix in row-echelon form.

Step 1 Form the augmented matrix for the original equations:

$$\left[\begin{array}{ccc|c} 1 & 0 & 2 & 6 \\ -3 & 4 & 6 & 30 \\ -1 & -2 & 3 & 8 \end{array} \right] \quad \begin{array}{l} x + 2z = 6 \\ -3x + 4y + 6z = 30 \\ -x - 2y + 3z = 8 \end{array}$$

Step 2 Add $3 \times$ row 1 to row 2, and add row 1 to row 3:

$$\left[\begin{array}{ccc|c} 1 & 0 & 2 & 6 \\ 0 & 4 & 12 & 48 \\ 0 & -2 & 5 & 14 \end{array} \right] \quad \begin{array}{l} R'_2 = R_2 + 3 \times R_1 \\ R'_3 = R_3 + R_1 \end{array} \quad \begin{array}{l} x + 2z = 6 \\ 4y + 12z = 48 \\ -2y + 5z = 14 \end{array}$$

Step 3 Add $\frac{1}{2} \times$ row 2 to row 3:

$$\left[\begin{array}{ccc|c} 1 & 0 & 2 & 6 \\ 0 & 4 & 12 & 48 \\ 0 & 0 & 11 & 38 \end{array} \right] \quad R'_3 = R_3 + \frac{1}{2} \times R_2 \quad \begin{array}{l} x + 2z = 6 \\ 4y + 12z = 48 \\ 11z = 38 \end{array}$$

a From the final system of equations, we obtain the solution

$$z = \frac{38}{11}, \quad y = \frac{18}{11}, \quad x = -\frac{10}{11}$$

b The equations represent three planes that intersect at the point $\left(-\frac{10}{11}, \frac{18}{11}, \frac{38}{11}\right)$.

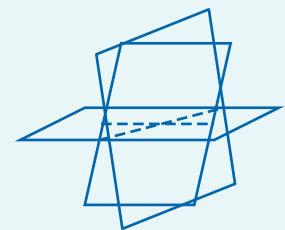

Note: If only one row operation is applied at each step, then the resulting system will be equivalent to the original system (i.e. the solution set will be the same).

Applying two row operations in one step can sometimes change the system. However, it is safe to use one row to modify two other rows. (In this example, we used row 1 to modify both row 2 and row 3 in Step 2.)

Three planes intersecting in a line

We now show how this method can be used when there are infinitely many solutions by repeating Example 6.

Example 8

The simultaneous equations $x + 2y + 3z = 13$, $-x - 3y + 2z = 2$ and $-x - 4y + 7z = 17$ have infinitely many solutions.

- Describe these solutions through the use of a parameter.
- Give a geometric interpretation of the solution.

Solution

We will obtain an augmented matrix in reduced row-echelon form.

Step 1 Form the augmented matrix for the original equations:

$$\left[\begin{array}{ccc|c} 1 & 2 & 3 & 13 \\ -1 & -3 & 2 & 2 \\ -1 & -4 & 7 & 17 \end{array} \right] \quad \begin{array}{l} x + 2y + 3z = 13 \\ -x - 3y + 2z = 2 \\ -x - 4y + 7z = 17 \end{array}$$

Step 2 Use row 1 to obtain 0s below the row leader of row 1:

$$\left[\begin{array}{ccc|c} 1 & 2 & 3 & 13 \\ 0 & -1 & 5 & 15 \\ 0 & -2 & 10 & 30 \end{array} \right] \quad \begin{array}{l} R'_2 = R_2 + R_1 \\ R'_3 = R_3 + R_1 \end{array}$$

Step 3 Obtain 1 as the row leader of row 2:

$$\left[\begin{array}{ccc|c} 1 & 2 & 3 & 13 \\ 0 & 1 & -5 & -15 \\ 0 & -2 & 10 & 30 \end{array} \right] \quad R'_2 = -R_2$$

Step 4 Use row 2 to obtain 0s above and below the row leader of row 2:

$$\left[\begin{array}{ccc|c} 1 & 0 & 13 & 43 \\ 0 & 1 & -5 & -15 \\ 0 & 0 & 0 & 0 \end{array} \right] \quad \begin{array}{l} R'_1 = R_1 - 2R_2 \\ R'_3 = R_3 + 2R_2 \end{array} \quad \begin{array}{l} x + 13z = 43 \\ y - 5z = -15 \\ 0 = 0 \end{array}$$

a We can find the solutions from the final system of equations.

Let $z = \lambda$. Then $y = 5\lambda - 15$ and $x = 43 - 13\lambda$.

b The equations represent three planes that intersect along the line given by the parametric equations $x = 43 - 13\lambda$, $y = 5\lambda - 15$, $z = \lambda$.

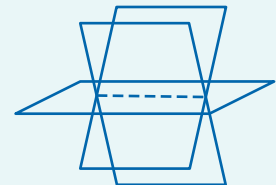

Note: To obtain the solutions from the final augmented matrix, we use a parameter for each variable without a row leader in its column. We then use the final equations to express the other variables in terms of these parameters.

Three planes with no common intersection



Example 9

Consider the system of equations $2x + y - z = 1$, $x - y + z = 3$ and $x + 5y - 5z = 2$.

- a** Show that this system of equations has no solution.
b Give a geometric interpretation of these equations.

Solution

$$\mathbf{a} \quad \begin{bmatrix} 2 & 1 & -1 & | & 1 \\ 1 & -1 & 1 & | & 3 \\ 1 & 5 & -5 & | & 2 \end{bmatrix} \quad \begin{array}{l} 2x + y - z = 1 \\ x - y + z = 3 \\ x + 5y - 5z = 2 \end{array}$$

$$\begin{bmatrix} 1 & \frac{1}{2} & -\frac{1}{2} & | & \frac{1}{2} \\ 1 & -1 & 1 & | & 3 \\ 1 & 5 & -5 & | & 2 \end{bmatrix} \quad R'_1 = \frac{1}{2}R_1$$

$$\begin{bmatrix} 1 & \frac{1}{2} & -\frac{1}{2} & | & \frac{1}{2} \\ 0 & -\frac{3}{2} & \frac{3}{2} & | & \frac{5}{2} \\ 0 & \frac{9}{2} & -\frac{9}{2} & | & \frac{3}{2} \end{bmatrix} \quad \begin{array}{l} R'_2 = R_2 - R_1 \\ R'_3 = R_3 - R_1 \end{array}$$

$$\begin{bmatrix} 1 & \frac{1}{2} & -\frac{1}{2} & | & \frac{1}{2} \\ 0 & 1 & -1 & | & -\frac{5}{3} \\ 0 & 1 & -1 & | & \frac{1}{3} \end{bmatrix} \quad \begin{array}{l} R'_2 = -\frac{2}{3}R_2 \\ R'_3 = \frac{2}{9}R_3 \end{array}$$

$$\begin{bmatrix} 1 & \frac{1}{2} & -\frac{1}{2} & | & \frac{1}{2} \\ 0 & 1 & -1 & | & -\frac{5}{3} \\ 0 & 0 & 0 & | & 2 \end{bmatrix} \quad \begin{array}{l} x + \frac{1}{2}y - \frac{1}{2}z = \frac{1}{2} \\ y - z = -\frac{5}{3} \\ 0 = 2 \end{array}$$

The final row corresponds to the equation $0x + 0y + 0z = 2$. There are no values of x , y and z that satisfy this equation, as $0 \neq 2$. So the system of equations has no solutions.

- b** The equations represent three planes that do not have any common intersection.

(Each pair of planes is non-parallel and therefore intersects in a line, but there is no point in common to the three planes.)

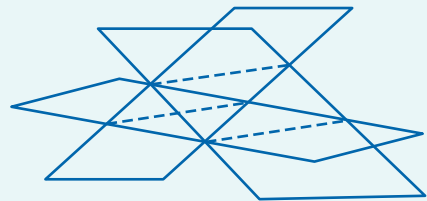

Further examples

So far we have seen three cases for a system of linear equations in three variables:

- unique solution (planes intersect at a point)
- infinitely many solutions with one parameter (planes intersect in a line)
- no solutions (planes have no common intersection).

A system of linear equations in three variables can also represent multiple copies of the same plane. For example:

$$x + 2y + 4z = 1$$

$$2x + 4y + 8z = 2$$

These two planes coincide, and the solution is the set of all points on the plane. We need to use two parameters. A possible form of the solution is

$$x = \lambda, \quad y = \mu, \quad z = \frac{1}{4}(1 - \lambda - 2\mu)$$

for $\lambda \in \mathbb{R}$ and $\mu \in \mathbb{R}$.



Example 10

Consider the system of equations

$$x + 2y - z = 2$$

$$2x + 5y - (a + 2)z = 3$$

$$-x + (a - 5)y + z = 1$$

- a** Represent the system of equations as an augmented matrix in row-echelon form.
- b** Find the values of a for which:
- i** there is a unique solution
 - ii** there are infinitely many solutions
 - iii** there are no solutions.
- c**
- i** Find the solution, in terms of a , when a satisfies the conditions of **b i**.
 - ii** Find the solutions when a satisfies the conditions of **b ii**.

Solution

$$\mathbf{a} \quad \left[\begin{array}{ccc|c} 1 & 2 & -1 & 2 \\ 2 & 5 & -(a+2) & 3 \\ -1 & a-5 & 1 & 1 \end{array} \right] \rightarrow \left[\begin{array}{ccc|c} 1 & 2 & -1 & 2 \\ 0 & 1 & -a & -1 \\ 0 & a-3 & 0 & 3 \end{array} \right] \begin{array}{l} R'_2 = R_2 - 2R_1 \\ R'_3 = R_3 + R_1 \end{array}$$

$$\rightarrow \left[\begin{array}{ccc|c} 1 & 2 & -1 & 2 \\ 0 & 1 & -a & -1 \\ 0 & 0 & a(a-3) & a \end{array} \right] \begin{array}{l} R'_3 = R_3 - (a-3)R_2 \end{array}$$

- b** From the last row of the augmented matrix, we have $a(a-3)z = a$.
- i** There is a unique solution if $a \neq 0$ and $a \neq 3$.
 - ii** There are infinitely many solutions if $a = 0$.
 - iii** There are no solutions if $a = 3$. In this case, the last row tells us that $0 = 3$.
- c**
- i** If $a \neq 0$ and $a \neq 3$, then the solution is $z = \frac{1}{a-3}$, $y = \frac{3}{a-3}$, $x = \frac{2a-11}{a-3}$.
 - ii** If $a = 0$, then we have $y = -1$. The first equation becomes $x - z = 4$. Let $z = \lambda$. Then $x = \lambda + 4$. The solutions give the line defined by $x = \lambda + 4$, $y = -1$, $z = \lambda$.

Exercise 7C

Skillsheet

1 Solve each of the following systems of linear equations using augmented matrices:

Example 7

a $2x - y + z = -7$	b $x + y - 3z = 6$	c $x + y + z = 10$
$x + 2y - 2z = 7$	$2x + 3y + 2z = 2$	$2x - y - 5z = 3$
$-2x + y + 3z = -1$	$x - 2y + z = -6$	$x + 2y - z = 1$

Example 8

2 Solve each of the following systems of linear equations using augmented matrices. Express the solutions using a parameter.

a $x + 2y - 5z = 7$	b $x + 2y = 10$	c $2x - y + z = 0$
$x + y - 2z = 5$	$3x + 2y - 4z = 18$	$y + 2z = 2$
$2x - 3y + 11z = 0$	$y + z = 3$	

Example 9

3 Show that the system of equations

$$\begin{aligned} 3x - y - 2z &= 0 \\ x - y - z &= -1 \\ 2x + 8y + 3z &= 10 \end{aligned}$$

has no solution.

4 For each of the following systems of equations:

- i** Determine whether the system has a unique solution, infinitely many solutions or no solutions.
- ii** Find the solutions if they exist.

a $x + y + 2z = 11$	b $2x - y + z = 4$
$2x + 4y - 3z = -2$	$x - 3y = 3$
$3x + 6y - 5z = -5$	$3x - 2y + z = 7$
c $2x - 3y + 5z = 7$	d $x + y + z = 7$
$9x - y + z = -1$	$2x - y + 3z = 15$
$x + 5y + 4z = 0$	$x - 8y + 4z = 6$

Example 10

5 a For which values of a will the following system have a unique solution, infinitely many solutions or no solutions?

$$\begin{aligned} x + 2y - 3z &= 4 \\ 3x - y + 5z &= 2 \\ 4x + y + (a^2 - 14)z &= a + 2 \end{aligned}$$

b Find the solutions (if any) in terms of a in each case.

- 6 a** For which values of a will the following system have a unique solution, infinitely many solutions or no solutions?

$$x + y + z = 4$$

$$2x + 3y + 3z = 10$$

$$x + y + (a^2 - 3)z = a + 2$$

- b** Find the solutions (if any) in terms of a in each case.
- 7** For each of the following pairs of planes, find a vector equation of the line of intersection:
- a** $2x + 3y + 3z = 10$, $x + 3y + 2z = 4$
- b** $2x - 5y - z = -3$, $x + 3y + z = 7$
- 8 a** For which value of a will the following system of equations, corresponding to three planes, have solutions?

$$2x + y + 3z = 1$$

$$x - 3y - z = 5$$

$$3x - 2y + 2z = a$$

- b** For this value of a , explain how these planes intersect with each other.
- c** For all other values of a , explain geometrically why the third plane does not intersect at the line of intersection of the other two planes.
- 9** Explain why the following planes do not have any common points of intersection:

$$x - 3y + 3z = 6$$

$$2x - 6y + 4z = 10$$

$$x - 3y + 2z = 4$$

- 10** Solve each of the following systems of linear equations using augmented matrices:

a $2x + 2y + 4z = 0$ **b** $x + 2y + 4z + w = 0$ **c** $5x + y + 4z + w = 0$

$-y - 3z + w = 0$ $2x + 3y + z + w = 0$ $2z - w = 0$

$3x + y + z + 2w = 0$ $3x - y + 2z + w = 0$ $z + w = 0$

$x + 3y - 2z - 2w = 0$ $7w = 0$

- 11** Find an equation of the form $ax + by + cz + d = 0$ to describe the plane containing the three points $(1, 2, -1)$, $(2, 3, 1)$ and $(3, -1, 2)$ by solving a system of three linear equations in a , b , c and d .



- 12** Find an equation of the form $ax + by + cz + d = 0$ to describe the plane containing the three points $(5, 4, 3)$, $(4, 3, 1)$ and $(1, 5, 4)$ by solving a system of three linear equations in a , b , c and d .



Chapter summary



General system of linear equations

$$\begin{array}{ccccccc} a_{11}x_1 + a_{12}x_2 + \cdots + a_{1n}x_n & = & b_1 \\ a_{21}x_1 + a_{22}x_2 + \cdots + a_{2n}x_n & = & b_2 \\ \vdots & & \vdots & \ddots & \vdots & & \vdots \\ a_{m1}x_1 + a_{m2}x_2 + \cdots + a_{mn}x_n & = & b_m \end{array}$$

Linear equations in two variables

- A linear equation of the form $ax + by = c$ represents a line in two-dimensional space (provided a and b are not both zero).
- There are three cases for a system of two linear equations in two variables:
 - unique solution (lines intersect at a point)
 - infinitely many solutions (lines coincide)
 - no solutions (lines are parallel).

Linear equations in three variables

- A linear equation of the form $ax + by + cz = d$ represents a plane in three-dimensional space (provided a , b and c are not all zero).
- There are four cases for a system of linear equations in three variables:
 - unique solution (planes intersect at a point)
 - infinitely many solutions with one parameter (planes intersect in a line)
 - infinitely many solutions with two parameters (planes coincide)
 - no solutions (planes have no common intersection).

Augmented matrices

- A system of three linear equations in three variables can be represented by an augmented matrix as shown:

$$\begin{array}{l} a_1x + b_1y + c_1z = d_1 \\ a_2x + b_2y + c_2z = d_2 \\ a_3x + b_3y + c_3z = d_3 \end{array} \quad \left[\begin{array}{ccc|c} a_1 & b_1 & c_1 & d_1 \\ a_2 & b_2 & c_2 & d_2 \\ a_3 & b_3 & c_3 & d_3 \end{array} \right]$$

- Each of the following **row operations** produces an equivalent system of equations (i.e. the solution set is the same):
 - Interchange two rows.
 - Multiply a row by a non-zero number.
 - Add a multiple of one row to another row.
- An augmented matrix is in **row-echelon form** if each successive row leader is further to the right, and so each row leader has only 0s below.
- An augmented matrix is in **reduced row-echelon form** if each successive row leader is further to the right, each row leader is 1, and each row leader has only 0s above and below.

Short-answer questions

- 1 Find the values of k for which the following system of equations has a unique solution:

$$2x - 3y = 4$$

$$x + ky = 2$$

- 2 Find the values of a for which the following system of equations has a unique solution:

$$ax + 3y + z = 2$$

$$5x - y - z = 1$$

$$x + 4y + 2z = 3$$

- 3 The augmented matrix of a system of equations has been converted to row-echelon form as follows.

$$\left[\begin{array}{ccc|c} 1 & 2 & 3 & 5 \\ 0 & a-2 & 0 & a^2-2a \\ 0 & 0 & a+1 & 3 \end{array} \right]$$

Find the values of a for which:

- a there are no solutions
 - b there are infinitely many solutions
 - c there is a unique solution.
- 4 Find the equation of the parabola $y = ax^2 + bx + c$ that passes through the three points $(-2, 40)$, $(1, 7)$ and $(3, 15)$.

- 5 Show that the following system of equations has a solution if and only if $a = 6$.

$$2x + 3y + 4z = 3$$

$$x + y - 8z = 1$$

$$5x + 6y - 20z = a$$

- 6 Consider the system of equations

$$x + y - z = 1$$

$$x + 2y + az = 3$$

$$x + ay + 2z = 4$$

Find the values of a for which there is:

- a a unique solution
 - b no solution
 - c more than one solution.
- 7 a Find a vector equation of the line of intersection of the planes with Cartesian equations $x - y + z = 1$ and $x + y - z = 3$.
- b Determine the points of intersection of this line with the sphere $x^2 + y^2 + z^2 = 9$.



Multiple-choice questions



- 1 Consider the system of simultaneous linear equations

$$\begin{aligned}bx + 3y &= 0 \\ 4x + (b + 1)y &= 0\end{aligned}$$

where b is a real constant. This system has infinitely many solutions for

- A** $b \in \mathbb{R}$ **B** $b \in \{-3, 4\}$ **C** $b \in \mathbb{R} \setminus \{-3, 4\}$
D $b \in \{-4, 3\}$ **E** $b \in \mathbb{R} \setminus \{-4, 3\}$
- 2 The simultaneous equations
- $$\begin{aligned}(a - 1)x + 5y &= 7 \\ 3x + (a - 3)y &= a\end{aligned}$$
- have a unique solution for
- A** $a \in \mathbb{R} \setminus \{-2, 6\}$ **B** $a \in \mathbb{R} \setminus \{0\}$ **C** $a \in \mathbb{R} \setminus \{6\}$
D $a = 6$ **E** $a = -2$
- 3 The solution of the two simultaneous equations $ax - 5by = 11$ and $4ax + 10by = 2$ for x and y , in terms of a and b , is
- A** $x = -\frac{10}{a}$, $y = -\frac{21}{5b}$ **B** $x = \frac{4}{a}$, $y = -\frac{7}{5b}$ **C** $x = \frac{13}{5a}$, $y = -\frac{42}{25b}$
D $x = \frac{13}{2a}$, $y = -\frac{9}{10b}$ **E** $x = -\frac{3}{a}$, $y = -\frac{14}{5b}$
- 4 Cara, Mai and Luke have purchased identical pencils and, while playing, got them all mixed up. Now the children need to divide 22 pencils between themselves. Luckily, Cara remembers that she had three more pencils than Mai did. Luke remembers that he had as many pencils as the other two combined. How many pencils did Cara have?
- A** 2 **B** 5 **C** 7 **D** 3 **E** 12

- 5 The system of equations

$$\begin{aligned}x - 2y + z &= 3 \\ 2x - 4y + 2z &= 7 \\ x + 3y - z &= 4\end{aligned}$$

can be interpreted geometrically as

- A** three planes that intersect at a point
B three planes that intersect in a line
C three parallel planes
D three planes with no common intersection, where two of the planes are parallel
E three planes with no common intersection, where no two of the planes are parallel

- 6** A system of linear equations corresponds to the augmented matrix in row-echelon form as shown.

$$\begin{array}{r} x + 2y - 3z = 3 \\ 2x - y - 4z = -2 \\ -2x + 5y + z = 7 \end{array} \quad \left[\begin{array}{ccc|c} 1 & 2 & -3 & 3 \\ 0 & -5 & 2 & -8 \\ 0 & 0 & -7 & -7 \end{array} \right]$$

A solution of this system of equations is

- A** $x = 2, y = 2, z = 1$ **B** $x = 3, y = 1, z = 1$ **C** $x = 3, y = 3, z = 2$
D $x = 2, y = 2, z = -1$ **E** $x = 3, y = 2, z = 3$

- 7** A system of linear equations corresponds to the augmented matrix in row-echelon form as shown.

$$\begin{array}{r} x + 2y - z = -3 \\ 3x + 5y + kz = -4 \\ 9x + (k + 13)y + 6z = 9 \end{array} \quad \left[\begin{array}{ccc|c} 1 & 2 & -1 & -3 \\ 0 & 1 & -k - 3 & -5 \\ 0 & 0 & k^2 - 2k & 5k + 11 \end{array} \right]$$

The system has a unique solution for

- A** $k \in \mathbb{R}$ **B** $k \in \mathbb{R} \setminus \{-3, 0, 2\}$ **C** $k = -3$
D $k = 0$ or $k = -2$ **E** $k \in \mathbb{R} \setminus \{0, 2\}$
- 8** A system of linear equations corresponds to the given augmented matrix after some elementary row operations have taken place.

$$\begin{array}{r} x - 2y + z = 11 \\ 3x + y - 2z = -2 \\ 4x + 3y + 4z = -11 \end{array} \quad \left[\begin{array}{ccc|c} 1 & -2 & 1 & 11 \\ 0 & 7 & m & -35 \\ 0 & 11 & n & -55 \end{array} \right]$$

The values of m and n are

- A** $m = -5, n = 0$ **B** $m = 5, n = 1$ **C** $m = 3, n = -1$
D $m = 0, n = 5$ **E** $m = -4, n = 2$
- 9** The planes with equations $x - y - z = 0$ and $2x + 4y - z = 0$ intersect along a straight line through the origin. A vector equation of this line is
- A** $t(5i - j + 6k), t \in \mathbb{R}$ **B** $t(i - 5j + k), t \in \mathbb{R}$
C $\frac{t}{6}(5i + j + 6k), t \in \mathbb{R}$ **D** $i - j - k + t(2i + 4j - k), t \in \mathbb{R}$
E $2i + 4j - k + t(i - j - k), t \in \mathbb{R}$
- 10** The planes $x - y - z = 0$ and $2x + 4y + z = 0$ intersect along a straight line through the origin. This line intersects the sphere with equation $x^2 + y^2 + z^2 = 6$ at the points

- A** $(\sqrt{6}, 0, 0), (0, \sqrt{6}, 0)$ **B** $(2, 1, 1), (2, 1, -1)$
C $(0, \sqrt{6}, 0), (0, -\sqrt{6}, 0)$ **D** $(1, -1, 2), (-1, 1, -2)$
E $(-1, -1, -2), (1, 1, 2)$



Extended-response questions

- 1** Bronwyn and Noel have a clothing warehouse in Summerville. They are supplied by three contractors: Brad, Flynn and Lina. The matrix shows the number of dresses, pants and shirts that one worker, for each of the contractors, can produce in a week.

	Brad	Flynn	Lina
Dresses	5	6	10
Pants	3	4	5
Shirts	2	6	5

- The number produced varies because of the different equipment used by the contractors. The warehouse requires 310 dresses, 175 pants and 175 shirts in a week.
- a** Write down a system of linear equations in three variables (the numbers x , y and z of workers for the contractors Brad, Flynn and Lina respectively).
- b** Write this system as an augmented matrix.
- c** How many workers should each contractor employ to meet the requirement exactly?
- 2** A quadratic function f has a rule of the form $f(x) = ax^2 + bx + c$. It is known that the points $(2, 0)$ and $(1, 1)$ are on the graph of f .
- a** Write down two linear equations satisfied by a , b and c .
- b** Find a and b in terms of c .
- c** Find the values of a , b and c if $f(-1) = 4$.
- 3** A quartic function f has a rule of the form $f(x) = ax^4 + bx^3 + cx^2 + dx$. The graph has a stationary point at $(1, 1)$ and passes through the point $(-1, 4)$.
- a** Write down three linear equations satisfied by a , b , c and d .
- b** Find a , b and c in terms of d .
- c** Find the value of d for which the graph has a stationary point where $x = 4$.
- 4** **a** Solve the simultaneous linear equations $x + 2y - z = 2$ and $2x - y + 3z = -1$.
- b** A third equation is $3x + p^2y - z = p + 4$. Find the values of p for which the system of three equations has:
- i** no solution **ii** a unique solution **iii** infinitely many solutions.
- 5** **a** Find a vector equation of the line of intersection of the two planes given by the equations $x - y - z = 1$ and $2x + 4y + z = 5$.
- b** A third plane has equation $3x + p^2y - z = p + 4$.
- i** Find the values of p for which the three planes intersect at a point, and give the coordinates of this point in terms of p .
- ii** Find the value of p for which the three planes intersect in a line.
- iii** Find the value of p for which the three planes intersect at the point $(1, 1, -1)$.
- c** Find the axis intercepts of the sphere $(x - 1)^2 + (y - 1)^2 + (z + 1)^2 = 3$.
- d** Find the coordinates of the points of intersection of the line found in part **a** with the sphere.



8

Complex numbers

Objectives

- ▶ To understand the **imaginary number** i and the set of **complex numbers** \mathbb{C} .
- ▶ To find the **real part** and the **imaginary part** of a complex number.
- ▶ To perform **addition, subtraction, multiplication** and **division** of complex numbers.
- ▶ To understand the concept of the **complex conjugate**.
- ▶ To represent complex numbers graphically on an **Argand diagram**.
- ▶ To work with complex numbers in **polar form**, and to understand the geometric interpretation of multiplication and division of complex numbers in this form.
- ▶ To understand and apply **De Moivre's theorem**.
- ▶ To **factorise** polynomial expressions over \mathbb{C} and to **solve** polynomial equations over \mathbb{C} .
- ▶ To sketch subsets of the **complex plane**, including lines, rays and circles.

In the sixteenth century, mathematicians including Girolamo Cardano began to consider square roots of negative numbers. Although these numbers were regarded as ‘impossible’, they arose in calculations to find real solutions of cubic equations.

For example, the cubic equation $x^3 - 15x - 4 = 0$ has three real solutions. Cardano's formula gives the solution

$$x = \sqrt[3]{2 + \sqrt{-121}} + \sqrt[3]{2 - \sqrt{-121}}$$

which you can show equals 4.

Today complex numbers are widely used in physics and engineering, such as in the study of aerodynamics.

8A Starting to build the complex numbers

Mathematicians in the eighteenth century introduced the imaginary number i with the property that

$$i^2 = -1$$

The equation $x^2 = -1$ has two solutions, namely i and $-i$.

By declaring that $i = \sqrt{-1}$, we can find square roots of all negative numbers.

For example:

$$\begin{aligned}\sqrt{-4} &= \sqrt{4 \times (-1)} \\ &= \sqrt{4} \times \sqrt{-1} \\ &= 2i\end{aligned}$$

Note: The identity $\sqrt{a} \times \sqrt{b} = \sqrt{ab}$ holds for positive real numbers a and b , but does not hold when both a and b are negative. In particular, $\sqrt{-1} \times \sqrt{-1} \neq \sqrt{(-1) \times (-1)}$.

► The set of complex numbers

A **complex number** is an expression of the form $a + bi$, where a and b are real numbers.

The set of all complex numbers is denoted by \mathbb{C} . That is,

$$\mathbb{C} = \{a + bi : a, b \in \mathbb{R}\}$$

The letter often used to denote a complex number is z .

Therefore if $z \in \mathbb{C}$, then $z = a + bi$ for some $a, b \in \mathbb{R}$.

- If $a = 0$, then $z = bi$ is said to be an **imaginary number**.
- If $b = 0$, then $z = a$ is a **real number**.

The real numbers and the imaginary numbers are subsets of \mathbb{C} .

Real and imaginary parts

For a complex number $z = a + bi$, we define

$$\operatorname{Re}(z) = a \quad \text{and} \quad \operatorname{Im}(z) = b$$

where $\operatorname{Re}(z)$ is called the **real part** of z and $\operatorname{Im}(z)$ is called the **imaginary part** of z .

Note: Both $\operatorname{Re}(z)$ and $\operatorname{Im}(z)$ are real numbers. That is, $\operatorname{Re}: \mathbb{C} \rightarrow \mathbb{R}$ and $\operatorname{Im}: \mathbb{C} \rightarrow \mathbb{R}$.

Example 1

Let $z = 4 - 5i$. Find:

a $\operatorname{Re}(z)$

b $\operatorname{Im}(z)$

c $\operatorname{Re}(z) - \operatorname{Im}(z)$

Solution

a $\operatorname{Re}(z) = 4$

b $\operatorname{Im}(z) = -5$

c $\operatorname{Re}(z) - \operatorname{Im}(z) = 4 - (-5) = 9$

Using the TI-Nspire

- Assign the complex number z , as shown in the first line. Use π to access i .
- To find the real part, use $\text{menu} > \text{Number} > \text{Complex Number Tools} > \text{Real Part}$, or just type $\text{real}()$.
- For the imaginary part, use $\text{menu} > \text{Number} > \text{Complex Number Tools} > \text{Imaginary Part}$.

Input	Output
$z := 4 - 5 \cdot i$	$4 - 5 \cdot i$
$\text{real}(z)$	4
$\text{imag}(z)$	-5
$\text{real}(z) - \text{imag}(z)$	9

Note: You do not need to be in complex mode. If you use i in the input, then it will display in the same format.

Using the Casio ClassPad

- In $\sqrt{\square}$, tap **Real** in the status bar at the bottom of the screen to change to **Cplx** mode.
- Enter $4 - 5i \Rightarrow z$ and tap EXE .

Note: The symbol i is found in the Math2 keyboard.

- Go to **Interactive** > **Complex** > **re**.
- Enter z and highlight.
- Go to **Interactive** > **Complex** > **im**.
- Highlight and drag the previous two entries to the next entry line and subtract as shown.

Input	Output
$4 - 5i \Rightarrow z$	$4 - 5 \cdot i$
$\text{re}(z)$	4
$\text{im}(z)$	-5
$\text{re}(z) - \text{im}(z)$	9

Example 2

- a** Represent $\sqrt{-5}$ as an imaginary number. **b** Simplify $2\sqrt{-9} + 4i$.

Solution

$$\begin{aligned} \mathbf{a} \quad \sqrt{-5} &= \sqrt{5 \times (-1)} \\ &= \sqrt{5} \times \sqrt{-1} \\ &= i\sqrt{5} \end{aligned}$$

$$\begin{aligned} \mathbf{b} \quad 2\sqrt{-9} + 4i &= 2\sqrt{9 \times (-1)} + 4i \\ &= 2 \times 3 \times i + 4i \\ &= 6i + 4i \\ &= 10i \end{aligned}$$

Using the TI-Nspire

Enter the expression and press enter .

Input	Output
$2 \cdot \sqrt{-9} + 4 \cdot i$	$10 \cdot i$

Using the Casio ClassPad

- Ensure your calculator is in complex mode (with **Cplx** in the status bar at the bottom of the main screen).
- Enter the expression and tap **(EXE)**.

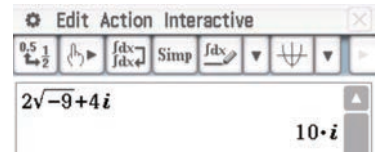

Equality of complex numbers

Two complex numbers are defined to be **equal** if both their real parts and their imaginary parts are equal:

$$a + bi = c + di \quad \text{if and only if} \quad a = c \text{ and } b = d$$

Example 3

Solve the equation $(2a - 3) + 2bi = 5 + 6i$ for $a \in \mathbb{R}$ and $b \in \mathbb{R}$.

Solution

If $(2a - 3) + 2bi = 5 + 6i$, then

$$2a - 3 = 5 \quad \text{and} \quad 2b = 6$$

$$\therefore \quad a = 4 \quad \text{and} \quad b = 3$$

► Operations on complex numbers

Addition and subtraction

Addition of complex numbers

If $z_1 = a + bi$ and $z_2 = c + di$, then

$$z_1 + z_2 = (a + c) + (b + d)i$$

The **zero** of the complex numbers can be written as $0 = 0 + 0i$.

If $z = a + bi$, then we define $-z = -a - bi$.

Subtraction of complex numbers

If $z_1 = a + bi$ and $z_2 = c + di$, then

$$z_1 - z_2 = z_1 + (-z_2) = (a - c) + (b - d)i$$

It is easy to check that the following familiar properties of the real numbers extend to the complex numbers:

- $z_1 + z_2 = z_2 + z_1$
- $(z_1 + z_2) + z_3 = z_1 + (z_2 + z_3)$
- $z + 0 = z$
- $z + (-z) = 0$

Multiplication by a scalar

If $z = a + bi$ and $k \in \mathbb{R}$, then

$$kz = k(a + bi) = ka + kbi$$

For example, if $z = 3 - 6i$, then $3z = 9 - 18i$.

It is easy to check that $k(z_1 + z_2) = kz_1 + kz_2$, for all $k \in \mathbb{R}$.

Example 4

Let $z_1 = 2 - 3i$ and $z_2 = 1 + 4i$. Simplify:

a $z_1 + z_2$

b $z_1 - z_2$

c $3z_1 - 2z_2$

Solution

a $z_1 + z_2$

$$\begin{aligned} &= (2 - 3i) + (1 + 4i) \\ &= 3 + i \end{aligned}$$

b $z_1 - z_2$

$$\begin{aligned} &= (2 - 3i) - (1 + 4i) \\ &= 1 - 7i \end{aligned}$$

c $3z_1 - 2z_2$

$$\begin{aligned} &= 3(2 - 3i) - 2(1 + 4i) \\ &= (6 - 9i) - (2 + 8i) \\ &= 4 - 17i \end{aligned}$$

Using the TI-Nspire

Enter the expressions as shown.

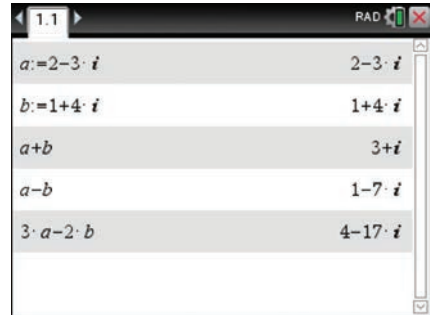

Using the Casio ClassPad

- Ensure your calculator is in complex mode (with **Cplx** in the status bar at the bottom of the main screen).
- Enter the expressions as shown.

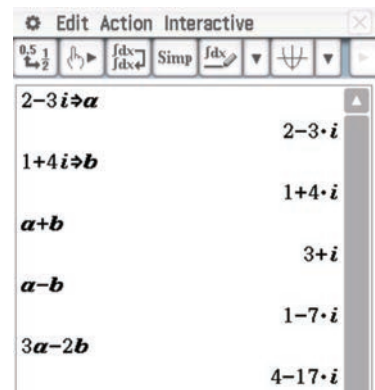

► Argand diagrams

An **Argand diagram** is a geometric representation of the set of complex numbers. In a vector sense, a complex number has two dimensions: the real part and the imaginary part. Therefore a plane is required to represent \mathbb{C} .

An Argand diagram is drawn with two perpendicular axes. The horizontal axis represents $\text{Re}(z)$, for $z \in \mathbb{C}$, and the vertical axis represents $\text{Im}(z)$, for $z \in \mathbb{C}$.

Each point on an Argand diagram represents a complex number. The complex number $a + bi$ is situated at the point (a, b) on the equivalent Cartesian axes, as shown by the examples in this figure.

A complex number written as $a + bi$ is said to be in **Cartesian form**.

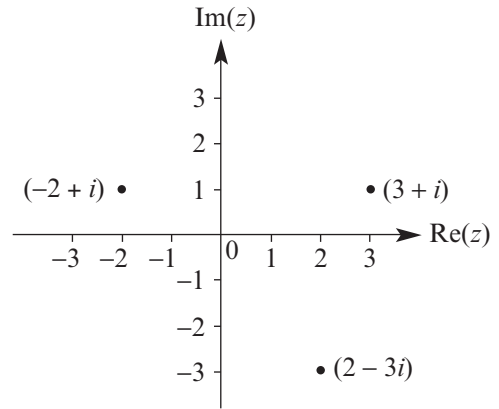

Example 5

Represent the following complex numbers as points on an Argand diagram:

- a** 2 **b** $-3i$ **c** $2 - i$
d $-(2 + 3i)$ **e** $-1 + 2i$

Solution

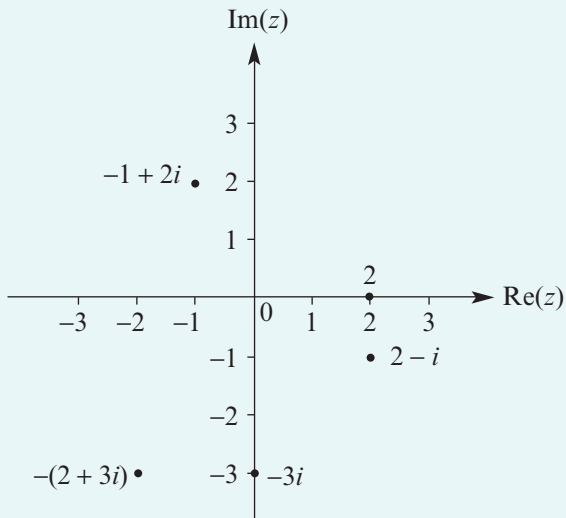

► Geometric representation of the basic operations on complex numbers

Addition of complex numbers is analogous to addition of vectors. The sum of two complex numbers corresponds to the sum of their position vectors.

Multiplication of a complex number by a scalar corresponds to the multiplication of its position vector by the scalar.

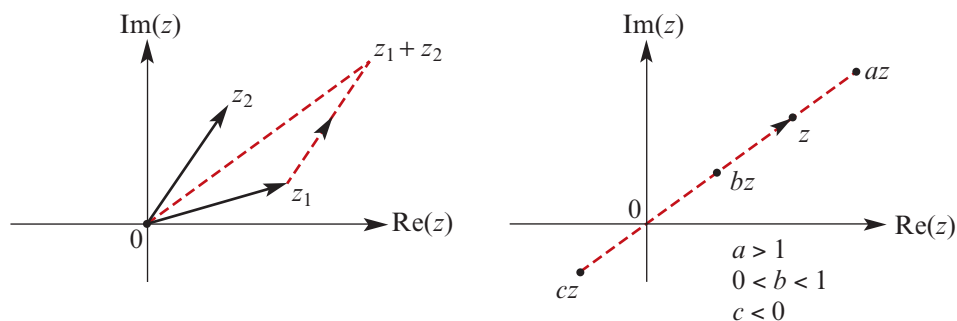

The difference $z_1 - z_2$ is represented by the sum $z_1 + (-z_2)$.

Example 6

Let $z_1 = 2 + i$ and $z_2 = -1 + 3i$.

Represent the complex numbers z_1 , z_2 , $z_1 + z_2$ and $z_1 - z_2$ on an Argand diagram and show the geometric interpretation of the sum and difference.

Solution

$$\begin{aligned} z_1 + z_2 &= (2 + i) + (-1 + 3i) \\ &= 1 + 4i \end{aligned}$$

$$\begin{aligned} z_1 - z_2 &= (2 + i) - (-1 + 3i) \\ &= 3 - 2i \end{aligned}$$

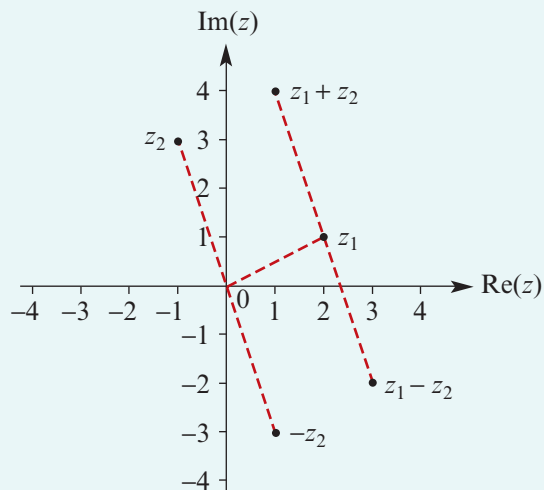

► Multiplication of complex numbers

Let $z_1 = a + bi$ and $z_2 = c + di$ (where $a, b, c, d \in \mathbb{R}$). Then

$$\begin{aligned} z_1 \times z_2 &= (a + bi)(c + di) \\ &= ac + adi + bci + bdi^2 \\ &= (ac - bd) + (ad + bc)i \quad (\text{since } i^2 = -1) \end{aligned}$$

We carried out this calculation with an assumption that we are in a system where all the usual rules of algebra apply. However, it should be understood that the following is a *definition* of multiplication for \mathbb{C} .

Multiplication of complex numbers

Let $z_1 = a + bi$ and $z_2 = c + di$. Then

$$z_1 \times z_2 = (ac - bd) + (ad + bc)i$$

The multiplicative identity for \mathbb{C} is $1 = 1 + 0i$. The following familiar properties of the real numbers extend to the complex numbers:

$$\blacksquare z_1 z_2 = z_2 z_1 \quad \blacksquare (z_1 z_2) z_3 = z_1 (z_2 z_3) \quad \blacksquare z \times 1 = z \quad \blacksquare z_1 (z_2 + z_3) = z_1 z_2 + z_1 z_3$$

Example 7

Simplify:

a $(2 + 3i)(1 - 5i)$ **b** $3i(5 - 2i)$ **c** i^3

Solution

$$\begin{aligned} \mathbf{a} \quad (2 + 3i)(1 - 5i) &= 2 - 10i + 3i - 15i^2 & \mathbf{b} \quad 3i(5 - 2i) &= 15i - 6i^2 & \mathbf{c} \quad i^3 &= i \times i^2 \\ &= 2 - 10i + 3i + 15 & &= 15i + 6 & &= -i \\ &= 17 - 7i & &= 6 + 15i & & \end{aligned}$$

► Geometric significance of multiplication by i

When the complex number $2 + 3i$ is multiplied by -1 , the result is $-2 - 3i$. This is achieved through a rotation of 180° about the origin.

When the complex number $2 + 3i$ is multiplied by i , we obtain

$$\begin{aligned} i(2 + 3i) &= 2i + 3i^2 \\ &= 2i - 3 \\ &= -3 + 2i \end{aligned}$$

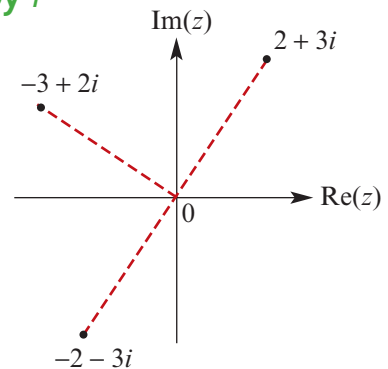

The result is achieved through a rotation of 90° anticlockwise about the origin.

If $-3 + 2i$ is multiplied by i , the result is $-2 - 3i$. This is again achieved through a rotation of 90° anticlockwise about the origin.

Powers of i

Successive multiplication by i gives the following:

$$\blacksquare i^0 = 1 \quad \blacksquare i^1 = i \quad \blacksquare i^2 = -1 \quad \blacksquare i^3 = -i$$

$$\blacksquare i^4 = (-1)^2 = 1 \quad \blacksquare i^5 = i \quad \blacksquare i^6 = -1 \quad \blacksquare i^7 = -i$$

In general, for $n = 0, 1, 2, 3, \dots$

$$\blacksquare i^{4n} = 1 \quad \blacksquare i^{4n+1} = i \quad \blacksquare i^{4n+2} = -1 \quad \blacksquare i^{4n+3} = -i$$

Exercise 8A

Example 1 1 Let $z = 6 - 7i$. Find:

a $\operatorname{Re}(z)$

b $\operatorname{Im}(z)$

c $\operatorname{Re}(z) - \operatorname{Im}(z)$

Example 2 2 Simplify each of the following:

a $\sqrt{-25}$

b $\sqrt{-27}$

c $2i - 7i$

d $5\sqrt{-16} - 7i$

e $\sqrt{-8} + \sqrt{-18}$

f $i\sqrt{-12}$

g $i(2 + i)$

h $\operatorname{Im}(2\sqrt{-4})$

i $\operatorname{Re}(5\sqrt{-49})$

Example 3 3 Solve the following equations for real values x and y :

a $x + yi = 5$

b $x + yi = 2i$

c $x = yi$

d $x + yi = (2 + 3i) + 7(1 - i)$

e $2x + 3 + 8i = -1 + (2 - 3y)i$

f $x + yi = (2y + 1) + (x - 7)i$

Example 4 4 Let $z_1 = 2 - i$, $z_2 = 3 + 2i$ and $z_3 = -1 + 3i$. Find:

a $z_1 + z_2$

b $z_1 + z_2 + z_3$

c $2z_1 - z_3$

d $3 - z_3$

e $4i - z_2 + z_1$

f $\operatorname{Re}(z_1)$

g $\operatorname{Im}(z_2)$

h $\operatorname{Im}(z_3 - z_2)$

i $\operatorname{Re}(z_2) - i\operatorname{Im}(z_2)$

Example 5 5 Represent each of the following complex numbers on an Argand diagram:

a $-4i$

b -3

c $2(1 + i)$

d $3 - i$

e $-(3 + 2i)$

f $-2 + 3i$

Example 6 6 Let $z_1 = 1 + 2i$ and $z_2 = 2 - i$.

a Represent the following complex numbers on an Argand diagram:

i z_1

ii z_2

iii $2z_1 + z_2$

iv $z_1 - z_2$

b Verify that parts **iii** and **iv** correspond to vector addition and subtraction.

Example 7 7 Simplify each of the following:

a $(5 - i)(2 + i)$

b $(4 + 7i)(3 + 5i)$

c $(2 + 3i)(2 - 3i)$

d $(1 + 3i)^2$

e $(2 - i)^2$

f $(1 + i)^3$

g i^4

h $i^{11}(6 + 5i)$

i i^{70}

8 Solve each of the following equations for real values x and y :

a $2x + (y + 4)i = (3 + 2i)(2 - i)$

b $(x + yi)(3 + 2i) = -16 + 11i$

c $(x + 2i)^2 = 5 - 12i$

d $(x + yi)^2 = -18i$

e $i(2x - 3yi) = 6(1 + i)$

9 a Represent each of the following complex numbers on an Argand diagram:

i $1 + i$ ii $(1 + i)^2$ iii $(1 + i)^3$ iv $(1 + i)^4$

b Describe any geometric pattern observed in the position of these complex numbers.

10 Let $z_1 = 2 + 3i$ and $z_2 = -1 + 2i$. Let P , Q and R be the points defined on an Argand diagram by z_1 , z_2 and $z_2 - z_1$ respectively.



a Show that $\overrightarrow{PQ} = \overrightarrow{OR}$.

b Hence find QP .

8B Modulus, conjugate and division

► The modulus of a complex number

Definition of the modulus

For $z = a + bi$, the **modulus** of z is denoted by $|z|$ and is defined by

$$|z| = \sqrt{a^2 + b^2}$$

This is the distance of the complex number from the origin.

For example, if $z_1 = 3 + 4i$ and $z_2 = -3 + 4i$, then

$$|z_1| = \sqrt{3^2 + 4^2} = 5 \quad \text{and} \quad |z_2| = \sqrt{(-3)^2 + 4^2} = 5$$

Both z_1 and z_2 are a distance of 5 units from the origin.

Properties of the modulus

- $|z_1 z_2| = |z_1| |z_2|$ (the modulus of a product is the product of the moduli)
- $\left| \frac{z_1}{z_2} \right| = \frac{|z_1|}{|z_2|}$ (the modulus of a quotient is the quotient of the moduli)
- $|z_1 + z_2| \leq |z_1| + |z_2|$ (triangle inequality)

These results will be proved in Exercise 8B.

► The conjugate of a complex number

Definition of the complex conjugate

For $z = a + bi$, the **complex conjugate** of z is denoted by \bar{z} and is defined by

$$\bar{z} = a - bi$$

Properties of the complex conjugate

- $\overline{z_1 + z_2} = \overline{z_1} + \overline{z_2}$
- $\overline{z_1 z_2} = \overline{z_1} \overline{z_2}$
- $\overline{kz} = k\overline{z}$, for $k \in \mathbb{R}$
- $z\overline{z} = |z|^2$
- $z + \overline{z} = 2 \operatorname{Re}(z)$

Proof The first three results will be proved in Exercise 8B. To prove the remaining two results, consider a complex number $z = a + bi$. Then $\overline{z} = a - bi$ and therefore

$$\begin{aligned} z\overline{z} &= (a + bi)(a - bi) & z + \overline{z} &= (a + bi) + (a - bi) \\ &= a^2 - abi + abi - b^2i^2 & &= 2a \\ &= a^2 + b^2 & &= 2 \operatorname{Re}(z) \\ &= |z|^2 \end{aligned}$$

It follows from these two results that if $z \in \mathbb{C}$, then $z\overline{z}$ and $z + \overline{z}$ are real numbers. We can prove a partial converse to this property of the complex conjugate:

Let $z, w \in \mathbb{C} \setminus \mathbb{R}$ such that zw and $z + w$ are real numbers. Then $w = \overline{z}$.

Proof Write $z = a + bi$ and $w = c + di$, where $b, d \neq 0$. Then

$$\begin{aligned} z + w &= (a + bi) + (c + di) \\ &= (a + c) + (b + d)i \end{aligned}$$

Since $z + w$ is real, we have $b + d = 0$. Therefore $d = -b$ and so

$$\begin{aligned} zw &= (a + bi)(c - bi) \\ &= (ac + b^2) + (bc - ab)i \end{aligned}$$

Since zw is real, we have $bc - ab = b(c - a) = 0$. As $b \neq 0$, this implies that $c = a$. We have shown that $w = a - bi = \overline{z}$.

Example 8

Find the complex conjugate of each of the following:

- a** 2 **b** $3i$ **c** $-1 - 5i$

Solution

- a** The complex conjugate of 2 is 2.
b The complex conjugate of $3i$ is $-3i$.
c The complex conjugate of $-1 - 5i$ is $-1 + 5i$.

Using the TI-Nspire

To find the complex conjugate, use $\boxed{\text{menu}}$
 $>$ **Number** $>$ **Complex Number Tools** $>$
Complex Conjugate, or just type $\text{conj}()$.

Note: Use $\boxed{\pi}$ to access i .



Using the Casio ClassPad

- Ensure your calculator is in complex mode.
- Enter and highlight 2.
- Go to **Interactive** > **Complex** > **conjg**.
- Repeat for $3i$ and $-1 - 5i$ as shown.

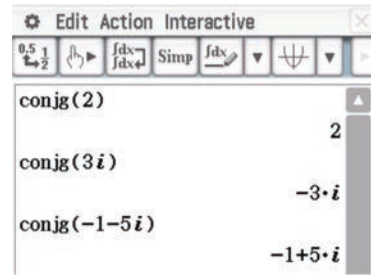

► Division of complex numbers

We begin with some familiar algebra that will motivate the definition:

$$\frac{1}{a+bi} = \frac{1}{a+bi} \times \frac{a-bi}{a-bi} = \frac{a-bi}{(a+bi)(a-bi)} = \frac{a-bi}{a^2+b^2}$$

We can see that

$$(a+bi) \times \frac{a-bi}{a^2+b^2} = 1$$

Although we have carried out this arithmetic, we have not yet defined what $\frac{1}{a+bi}$ means.

Multiplicative inverse of a complex number

If $z = a + bi$ with $z \neq 0$, then

$$z^{-1} = \frac{a-bi}{a^2+b^2} = \frac{\bar{z}}{|z|^2}$$

The formal definition of division in the complex numbers is via the multiplicative inverse:

Division of complex numbers

$$\frac{z_1}{z_2} = z_1 z_2^{-1} = \frac{z_1 \bar{z}_2}{|z_2|^2} \quad (\text{for } z_2 \neq 0)$$

Here is the procedure that is used in practice:

Assume that $z_1 = a + bi$ and $z_2 = c + di$ (where $a, b, c, d \in \mathbb{R}$). Then

$$\frac{z_1}{z_2} = \frac{a+bi}{c+di}$$

Multiply the numerator and denominator by the conjugate of z_2 :

$$\begin{aligned} \frac{z_1}{z_2} &= \frac{a+bi}{c+di} \times \frac{c-di}{c-di} \\ &= \frac{(a+bi)(c-di)}{c^2+d^2} \end{aligned}$$

Complete the division by simplifying. This process is demonstrated in the next example.

Example 9

a Write each of the following in the form $a + bi$, where $a, b \in \mathbb{R}$:

i $\frac{1}{3-2i}$ **ii** $\frac{4+i}{3-2i}$

b Simplify $\frac{(1+2i)^2}{i(1+3i)}$.

Solution

$$\begin{aligned} \text{a i} \quad \frac{1}{3-2i} &= \frac{1}{3-2i} \times \frac{3+2i}{3+2i} & \text{ii} \quad \frac{4+i}{3-2i} &= \frac{4+i}{3-2i} \times \frac{3+2i}{3+2i} \\ &= \frac{3+2i}{3^2 - (2i)^2} & &= \frac{(4+i)(3+2i)}{3^2 + 2^2} \\ &= \frac{3+2i}{13} & &= \frac{12+8i+3i-2}{13} \\ &= \frac{3}{13} + \frac{2}{13}i & &= \frac{10}{13} + \frac{11}{13}i \end{aligned}$$

$$\begin{aligned} \text{b} \quad \frac{(1+2i)^2}{i(1+3i)} &= \frac{1+4i-4}{-3+i} \\ &= \frac{-3+4i}{-3+i} \times \frac{-3-i}{-3-i} \\ &= \frac{9+3i-12i+4}{(-3)^2 - i^2} \\ &= \frac{13-9i}{10} \\ &= \frac{13}{10} - \frac{9}{10}i \end{aligned}$$

Note: There is an obvious similarity between the process for expressing a complex number with a real denominator and the process for rationalising the denominator of a surd expression.

Using the TI-Nspire

Complete as shown.

The image shows a TI-Nspire calculator screen with the following display:

$\frac{1}{3-2i}$	$\frac{3+2i}{13} + \frac{2}{13}i$
$\frac{4+i}{3-2i}$	$\frac{10}{13} + \frac{11}{13}i$

Using the Casio ClassPad

Ensure your calculator is in complex mode and complete as shown.

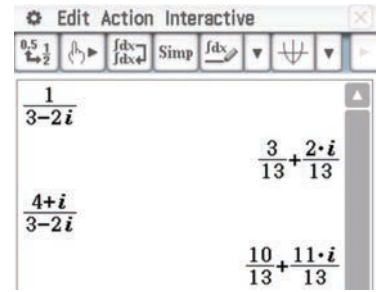

Exercise 8B

Example 8 1 Find the complex conjugate of each of the following complex numbers:

a $\sqrt{3}$

b $8i$

c $4 - 3i$

d $-(1 + 2i)$

e $4 + 2i$

f $-3 - 2i$

Example 9 2 Simplify each of the following, giving your answer in the form $a + bi$:

a $\frac{2 + 3i}{3 - 2i}$

b $\frac{i}{-1 + 3i}$

c $\frac{-4 - 3i}{i}$

d $\frac{3 + 7i}{1 + 2i}$

e $\frac{\sqrt{3} + i}{-1 - i}$

f $\frac{17}{4 - i}$

3 Let $z = a + bi$ and $w = c + di$. Show that:

a $\overline{z + w} = \bar{z} + \bar{w}$

b $\overline{zw} = \bar{z} \bar{w}$

c $\overline{\left(\frac{z}{w}\right)} = \frac{\bar{z}}{\bar{w}}$

d $|zw| = |z||w|$

e $\left|\frac{z}{w}\right| = \frac{|z|}{|w|}$

4 Let $z = 2 - i$. Simplify the following:

a $z(z + 1)$

b $\frac{z}{z + 4}$

c $\overline{z - 2i}$

d $\frac{z - 1}{z + 1}$

e $(z - i)^2$

f $(z + 1 + 2i)^2$

5 For $z = a + bi$, write each of the following in terms of a and b :

a $z\bar{z}$

b $\frac{z}{|z|^2}$

c $z + \bar{z}$

d $z - \bar{z}$

e $\frac{z}{\bar{z}}$

f $\frac{\bar{z}}{z}$



6 Prove that $|z_1 + z_2| \leq |z_1| + |z_2|$ for all $z_1, z_2 \in \mathbb{C}$.

8C The polar form of a complex number

In the preceding sections, we have expressed complex numbers in Cartesian form. Another way of expressing complex numbers is using polar form.

Each complex number may be described by an angle and a distance from the origin. In this section, we will see that this is a very useful way to describe complex numbers.

► Polar form

The diagram shows the point P corresponding to the complex number $z = a + bi$. We see that $a = r \cos \theta$ and $b = r \sin \theta$, and so we can write

$$\begin{aligned} z &= a + bi \\ &= r \cos \theta + (r \sin \theta) i \\ &= r(\cos \theta + i \sin \theta) \end{aligned}$$

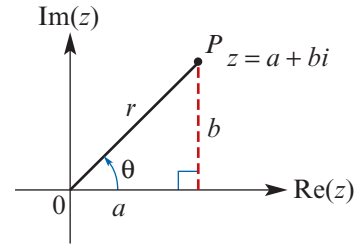

This is called the **polar form** of the complex number. The polar form is abbreviated to

$$z = r \operatorname{cis} \theta$$

- The distance $r = \sqrt{a^2 + b^2}$ is called the **modulus** of z and is denoted by $|z|$.
- The angle θ , measured anticlockwise from the horizontal axis, is called the **argument** of z and is denoted by $\arg z$.

Polar form for complex numbers is also called **modulus–argument form**.

This Argand diagram uses a polar grid with rays at intervals of $\frac{\pi}{12} = 15^\circ$.

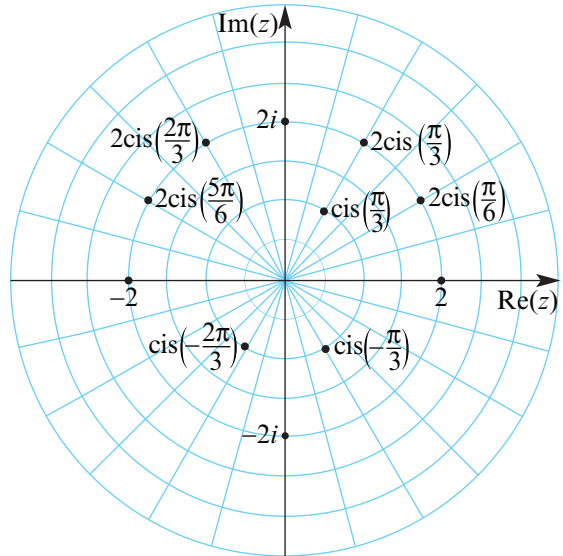

► Non-uniqueness of polar form

Each complex number has more than one representation in polar form.

Since $\cos \theta = \cos(\theta + 2n\pi)$ and $\sin \theta = \sin(\theta + 2n\pi)$, for all $n \in \mathbb{Z}$, we can write

$$z = r \operatorname{cis} \theta = r \operatorname{cis}(\theta + 2n\pi) \quad \text{for all } n \in \mathbb{Z}$$

The convention is to use the angle θ such that $-\pi < \theta \leq \pi$.

Principal value of the argument

For a non-zero complex number z , the argument of z that belongs to the interval $(-\pi, \pi]$ is called the **principal value** of the argument of z and is denoted by $\text{Arg } z$. That is,

$$-\pi < \text{Arg } z \leq \pi$$

► **Complex conjugate in polar form**

It is easy to show that the complex conjugate, \bar{z} , is a reflection of the point z in the horizontal axis.

Therefore, if $z = r \text{cis } \theta$, then $\bar{z} = r \text{cis } (-\theta)$.

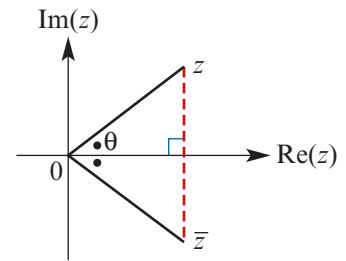
**Example 10**

Find the modulus and principal argument of each of the following complex numbers:

a 4

b $-2i$

c $1 + i$

d $4 - 3i$

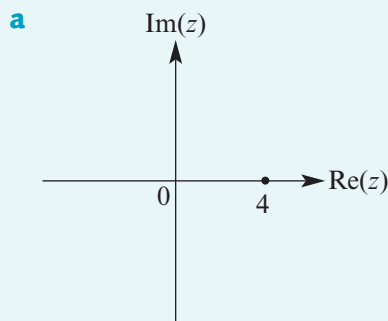
Solution

$$|4| = 4, \quad \text{Arg}(4) = 0$$

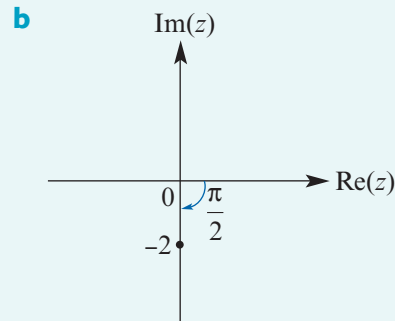

$$|-2i| = 2, \quad \text{Arg}(-2i) = -\frac{\pi}{2}$$

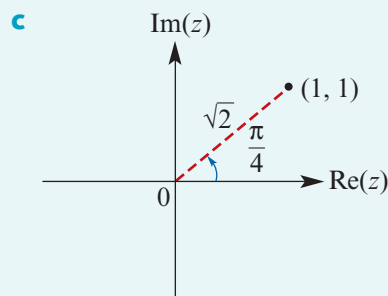

$$|1 + i| = \sqrt{1^2 + 1^2} = \sqrt{2}$$

$$\text{Arg}(1 + i) = \frac{\pi}{4}$$

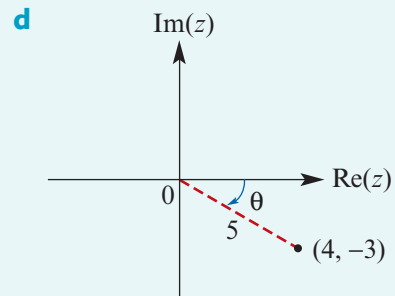

$$|4 - 3i| = \sqrt{4^2 + (-3)^2} = 5$$

$$\text{Arg}(4 - 3i) = -\tan^{-1}\left(\frac{3}{4}\right)$$

$$\approx -0.64 \text{ radians}$$

Using the TI-Nspire

- To find the modulus of a complex number, use **menu** > **Number** > **Complex Number Tools** > **Magnitude**.

Alternatively, use $|\square|$ from the 2D-template palette $\left(\frac{\square}{|\square|}\right)$ or type `abs(`.

- To find the principal value of the argument, use **menu** > **Number** > **Complex Number Tools** > **Polar Angle**.

Note: Use π to access i .

Expression	Result
<code>angle(4)</code>	0
<code> -2 · i </code>	2
<code>angle(-2 · i)</code>	$-\frac{\pi}{2}$
<code> 1 + i </code>	$\sqrt{2}$
<code>angle(1 + i)</code>	$\frac{\pi}{4}$

Expression	Result
<code>angle(4 - 3 · i)</code>	$-\tan^{-1}\left(\frac{3}{4}\right)$
<code> 4 - 3 · i </code>	5

Using the Casio ClassPad

- Ensure your calculator is in complex mode (with **Cplx** in the status bar at the bottom of the main screen).
- To find the modulus of a complex number, tap on the modulus template in the **Math2** keyboard, then enter the expression.
- To find the principal argument of a complex number, enter and highlight the expression, then select **Interactive** > **Complex** > **arg**.

Expression	Result
<code> 2 </code>	2
<code> -2 i </code>	2
<code> 1 + i </code>	$\sqrt{2}$
<code> 4 - 3 i </code>	5

Expression	Result
<code>arg(2)</code>	0
<code>arg(-2 i)</code>	$-\frac{\pi}{2}$
<code>arg(1 + i)</code>	$\frac{\pi}{4}$
<code>arg(4 - 3 i)</code>	$-\tan^{-1}\left(\frac{3}{4}\right)$

Example 11

Find the argument of $-1 - i$ in the interval $[0, 2\pi]$.

Solution

Choosing the angle in the interval $[0, 2\pi]$ gives

$$\arg(-1 - i) = \frac{5\pi}{4}$$

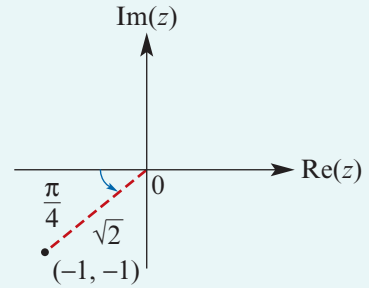
**Example 12**

Express $-\sqrt{3} + i$ in the form $r \operatorname{cis} \theta$, where $\theta = \operatorname{Arg}(-\sqrt{3} + i)$.

Solution

$$\begin{aligned} r &= |-\sqrt{3} + i| \\ &= \sqrt{(\sqrt{3})^2 + 1^2} = 2 \end{aligned}$$

$$\theta = \operatorname{Arg}(-\sqrt{3} + i) = \frac{5\pi}{6}$$

$$\text{Therefore } -\sqrt{3} + i = 2 \operatorname{cis}\left(\frac{5\pi}{6}\right)$$

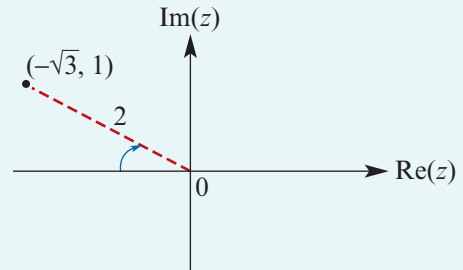
**Example 13**

Express $2 \operatorname{cis}\left(\frac{-3\pi}{4}\right)$ in the form $a + bi$.

Solution

$$\begin{aligned} a &= r \cos \theta & b &= r \sin \theta \\ &= 2 \cos\left(\frac{-3\pi}{4}\right) & &= 2 \sin\left(\frac{-3\pi}{4}\right) \\ &= -2 \cos\left(\frac{\pi}{4}\right) & &= -2 \sin\left(\frac{\pi}{4}\right) \\ &= -2 \times \frac{1}{\sqrt{2}} & &= -2 \times \frac{1}{\sqrt{2}} \\ &= -\sqrt{2} & &= -\sqrt{2} \end{aligned}$$

$$\text{Therefore } 2 \operatorname{cis}\left(\frac{-3\pi}{4}\right) = -\sqrt{2} - \sqrt{2}i$$

Exercise 8C

Example 10 1 Find the modulus and principal argument of each of the following complex numbers:

a -3	b $5i$	c $i - 1$
d $\sqrt{3} + i$	e $2 - 2\sqrt{3}i$	f $(2 - 2\sqrt{3}i)^2$

2 Find the principal argument of each of the following, correct to two decimal places:

a $5 + 12i$	b $-8 + 15i$	c $-4 - 3i$
d $1 - \sqrt{2}i$	e $\sqrt{2} + \sqrt{3}i$	f $-(3 + 7i)$

Example 11 3 Find the argument of each of the following in the interval stated:

a $1 - \sqrt{3}i$ in $[0, 2\pi]$	b $-7i$ in $[0, 2\pi]$
c $-3 + \sqrt{3}i$ in $[0, 2\pi]$	d $\sqrt{2} + \sqrt{2}i$ in $[0, 2\pi]$
e $\sqrt{3} + i$ in $[-2\pi, 0]$	f $2i$ in $[-2\pi, 0]$

4 Convert each of the following arguments into principal arguments:

a $\frac{5\pi}{4}$	b $\frac{17\pi}{6}$	c $\frac{-15\pi}{8}$	d $\frac{-5\pi}{2}$
---------------------------	----------------------------	-----------------------------	----------------------------

Example 12 5 Convert each of the following complex numbers from Cartesian form $a + bi$ into the form $r \operatorname{cis} \theta$, where $\theta = \operatorname{Arg}(a + bi)$:

a $-1 - i$	b $\frac{1}{2} - \frac{\sqrt{3}}{2}i$	c $\sqrt{3} - \sqrt{3}i$
d $\frac{1}{\sqrt{3}} + \frac{1}{3}i$	e $\sqrt{6} - \sqrt{2}i$	f $-2\sqrt{3} + 2i$

Example 13 6 Convert each of the following complex numbers into the form $a + bi$:

a $2 \operatorname{cis}\left(\frac{3\pi}{4}\right)$	b $5 \operatorname{cis}\left(\frac{-\pi}{3}\right)$	c $2\sqrt{2} \operatorname{cis}\left(\frac{\pi}{4}\right)$
d $3 \operatorname{cis}\left(\frac{-5\pi}{6}\right)$	e $6 \operatorname{cis}\left(\frac{\pi}{2}\right)$	f $4 \operatorname{cis} \pi$

7 Let $z = \operatorname{cis} \theta$. Show that:

a $ z = 1$	b $\frac{1}{z} = \operatorname{cis}(-\theta)$
--------------------	--

8 Find the complex conjugate of each of the following:

a $2 \operatorname{cis}\left(\frac{3\pi}{4}\right)$	b $7 \operatorname{cis}\left(\frac{-2\pi}{3}\right)$
c $-3 \operatorname{cis}\left(\frac{2\pi}{3}\right)$	d $5 \operatorname{cis}\left(\frac{-\pi}{4}\right)$



8D Basic operations on complex numbers in polar form

► Addition and subtraction

There is no simple way to add or subtract complex numbers in the form $r \operatorname{cis} \theta$. Complex numbers need to be expressed in the form $a + bi$ before these operations can be carried out.

Example 14

Simplify $2 \operatorname{cis}\left(\frac{\pi}{3}\right) + 3 \operatorname{cis}\left(\frac{2\pi}{3}\right)$.

Solution

First convert to Cartesian form:

$$\begin{aligned} 2 \operatorname{cis}\left(\frac{\pi}{3}\right) &= 2 \left(\cos\left(\frac{\pi}{3}\right) + i \sin\left(\frac{\pi}{3}\right) \right) & 3 \operatorname{cis}\left(\frac{2\pi}{3}\right) &= 3 \left(\cos\left(\frac{2\pi}{3}\right) + i \sin\left(\frac{2\pi}{3}\right) \right) \\ &= 2 \left(\frac{1}{2} + \frac{\sqrt{3}}{2}i \right) & &= 3 \left(-\frac{1}{2} + \frac{\sqrt{3}}{2}i \right) \\ &= 1 + \sqrt{3}i & &= -\frac{3}{2} + \frac{3\sqrt{3}}{2}i \end{aligned}$$

Now we have

$$\begin{aligned} 2 \operatorname{cis}\left(\frac{\pi}{3}\right) + 3 \operatorname{cis}\left(\frac{2\pi}{3}\right) &= (1 + \sqrt{3}i) + \left(-\frac{3}{2} + \frac{3\sqrt{3}}{2}i\right) \\ &= -\frac{1}{2} + \frac{5\sqrt{3}}{2}i \end{aligned}$$

► Multiplication by a scalar

Positive scalar

If $k \in \mathbb{R}^+$, then $\operatorname{Arg}(kz) = \operatorname{Arg}(z)$

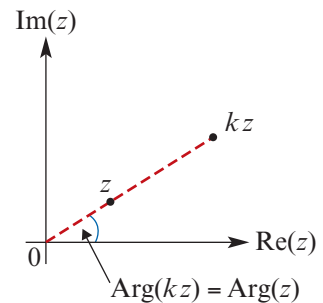

Negative scalar

If $k \in \mathbb{R}^-$, then

$$\operatorname{Arg}(kz) = \begin{cases} \operatorname{Arg}(z) - \pi, & 0 < \operatorname{Arg}(z) \leq \pi \\ \operatorname{Arg}(z) + \pi, & -\pi < \operatorname{Arg}(z) \leq 0 \end{cases}$$

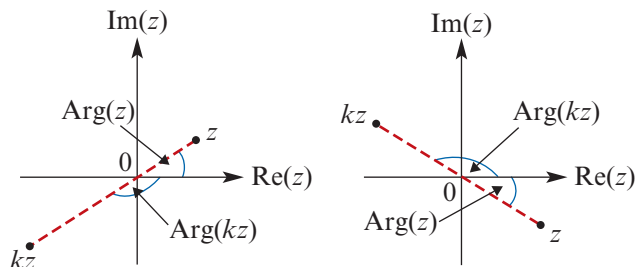

► Multiplication of complex numbers

Multiplication in polar form

If $z_1 = r_1 \operatorname{cis} \theta_1$ and $z_2 = r_2 \operatorname{cis} \theta_2$, then

$$z_1 z_2 = r_1 r_2 \operatorname{cis}(\theta_1 + \theta_2) \quad (\text{multiply the moduli and add the angles})$$

Proof We have

$$\begin{aligned} z_1 z_2 &= r_1 \operatorname{cis} \theta_1 \times r_2 \operatorname{cis} \theta_2 \\ &= r_1 r_2 (\cos \theta_1 + i \sin \theta_1)(\cos \theta_2 + i \sin \theta_2) \\ &= r_1 r_2 (\cos \theta_1 \cos \theta_2 + i \cos \theta_1 \sin \theta_2 + i \sin \theta_1 \cos \theta_2 - \sin \theta_1 \sin \theta_2) \\ &= r_1 r_2 ((\cos \theta_1 \cos \theta_2 - \sin \theta_1 \sin \theta_2) + i(\cos \theta_1 \sin \theta_2 + \sin \theta_1 \cos \theta_2)) \end{aligned}$$

Now use the compound angle formulas from Chapter 3:

$$\sin(\theta_1 + \theta_2) = \sin \theta_1 \cos \theta_2 + \cos \theta_1 \sin \theta_2$$

$$\cos(\theta_1 + \theta_2) = \cos \theta_1 \cos \theta_2 - \sin \theta_1 \sin \theta_2$$

$$\begin{aligned} \text{Hence } z_1 z_2 &= r_1 r_2 (\cos(\theta_1 + \theta_2) + i \sin(\theta_1 + \theta_2)) \\ &= r_1 r_2 \operatorname{cis}(\theta_1 + \theta_2) \end{aligned}$$

Here are two useful properties of the modulus and the principal argument with regard to multiplication of complex numbers:

- $|z_1 z_2| = |z_1| |z_2|$
- $\operatorname{Arg}(z_1 z_2) = \operatorname{Arg}(z_1) + \operatorname{Arg}(z_2) + 2k\pi$, where $k = 0, 1$ or -1

► Geometric interpretation of multiplication

We have seen that:

- The modulus of the product of two complex numbers is the product of their moduli.
- The argument of the product of two complex numbers is the sum of their arguments.

Geometrically, the effect of multiplying a complex number z_1 by the complex number $z_2 = r_2 \operatorname{cis} \theta_2$ is to produce an enlargement of Oz_1 , where O is the origin, by a factor of r_2 and an anticlockwise turn through an angle θ_2 about the origin.

If $r_2 = 1$, then only the turning effect will take place.

Let $z = \operatorname{cis} \theta$. Multiplication by z^2 is, in effect, the same as a multiplication by z followed by another multiplication by z . The effect is a turn of θ followed by another turn of θ . The end result is an anticlockwise turn of 2θ . This is also shown by finding z^2 :

$$\begin{aligned} z^2 &= z \times z = \operatorname{cis} \theta \times \operatorname{cis} \theta = \operatorname{cis}(\theta + \theta) \quad \text{using the multiplication rule} \\ &= \operatorname{cis}(2\theta) \end{aligned}$$

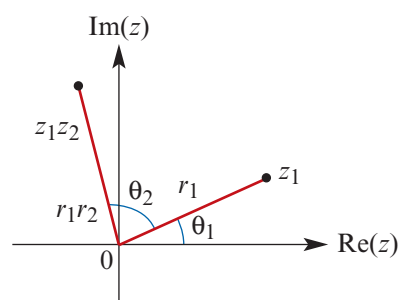

► Division of complex numbers

Division in polar form

If $z_1 = r_1 \operatorname{cis} \theta_1$ and $z_2 = r_2 \operatorname{cis} \theta_2$ with $r_2 \neq 0$, then

$$\frac{z_1}{z_2} = \frac{r_1}{r_2} \operatorname{cis}(\theta_1 - \theta_2) \quad (\text{divide the moduli and subtract the angles})$$

Proof We have already seen that $\frac{1}{\operatorname{cis} \theta_2} = \operatorname{cis}(-\theta_2)$.

We can now use the rule for multiplication in polar form to obtain

$$\frac{z_1}{z_2} = \frac{r_1 \operatorname{cis} \theta_1}{r_2 \operatorname{cis} \theta_2} = \frac{r_1}{r_2} \operatorname{cis} \theta_1 \operatorname{cis}(-\theta_2) = \frac{r_1}{r_2} \operatorname{cis}(\theta_1 - \theta_2)$$

Here are three useful properties of the modulus and the principal argument with regard to division of complex numbers:

- $\left| \frac{z_1}{z_2} \right| = \frac{|z_1|}{|z_2|}$
- $\operatorname{Arg}\left(\frac{z_1}{z_2}\right) = \operatorname{Arg}(z_1) - \operatorname{Arg}(z_2) + 2k\pi$, where $k = 0, 1$ or -1
- $\operatorname{Arg}\left(\frac{1}{z}\right) = -\operatorname{Arg}(z)$, provided z is not a negative real number

Example 15

Simplify:

$$\mathbf{a} \quad 2 \operatorname{cis}\left(\frac{\pi}{3}\right) \times \sqrt{3} \operatorname{cis}\left(\frac{3\pi}{4}\right) \quad \mathbf{b} \quad \frac{2 \operatorname{cis}\left(\frac{2\pi}{3}\right)}{4 \operatorname{cis}\left(\frac{\pi}{5}\right)}$$

Solution

$$\begin{aligned} \mathbf{a} \quad 2 \operatorname{cis}\left(\frac{\pi}{3}\right) \times \sqrt{3} \operatorname{cis}\left(\frac{3\pi}{4}\right) &= 2\sqrt{3} \operatorname{cis}\left(\frac{\pi}{3} + \frac{3\pi}{4}\right) \\ &= 2\sqrt{3} \operatorname{cis}\left(\frac{13\pi}{12}\right) \\ &= 2\sqrt{3} \operatorname{cis}\left(-\frac{11\pi}{12}\right) \end{aligned}$$

$$\begin{aligned} \mathbf{b} \quad \frac{2 \operatorname{cis}\left(\frac{2\pi}{3}\right)}{4 \operatorname{cis}\left(\frac{\pi}{5}\right)} &= \frac{1}{2} \operatorname{cis}\left(\frac{2\pi}{3} - \frac{\pi}{5}\right) \\ &= \frac{1}{2} \operatorname{cis}\left(\frac{7\pi}{15}\right) \end{aligned}$$

Note: A solution giving the principal value of the argument, that is, the argument in the range $(-\pi, \pi]$, is preferred unless otherwise stated.

► De Moivre's theorem

De Moivre's theorem allows us to readily simplify expressions of the form z^n when z is expressed in polar form.

De Moivre's theorem

$$(r \operatorname{cis} \theta)^n = r^n \operatorname{cis}(n\theta), \text{ where } n \in \mathbb{Z}$$

Proof This result is usually proved by mathematical induction, but can be explained by a simple inductive argument.

$$\text{Let } z = \operatorname{cis} \theta$$

$$\text{Then } z^2 = \operatorname{cis} \theta \times \operatorname{cis} \theta = \operatorname{cis}(2\theta) \quad \text{by the multiplication rule}$$

$$z^3 = z^2 \times \operatorname{cis} \theta = \operatorname{cis}(3\theta)$$

$$z^4 = z^3 \times \operatorname{cis} \theta = \operatorname{cis}(4\theta)$$

Continuing in this way, we see that $(\operatorname{cis} \theta)^n = \operatorname{cis}(n\theta)$, for each positive integer n .

To obtain the result for negative integers, again let $z = \operatorname{cis} \theta$. Then

$$z^{-1} = \frac{1}{z} = \bar{z} = \operatorname{cis}(-\theta)$$

For $k \in \mathbb{N}$, we have

$$z^{-k} = (z^{-1})^k = (\operatorname{cis}(-\theta))^k = \operatorname{cis}(-k\theta)$$

using the result for positive integers.



Example 16

Simplify:

$$\mathbf{a} \left(\operatorname{cis}\left(\frac{\pi}{3}\right)\right)^9$$

$$\mathbf{b} \frac{\operatorname{cis}\left(\frac{7\pi}{4}\right)}{\left(\operatorname{cis}\left(\frac{\pi}{3}\right)\right)^7}$$

Solution

$$\mathbf{a} \left(\operatorname{cis}\left(\frac{\pi}{3}\right)\right)^9 = \operatorname{cis}\left(9 \times \frac{\pi}{3}\right)$$

$$= \operatorname{cis}(3\pi)$$

$$= \operatorname{cis} \pi$$

$$= \cos \pi + i \sin \pi$$

$$= -1$$

$$\mathbf{b} \frac{\operatorname{cis}\left(\frac{7\pi}{4}\right)}{\left(\operatorname{cis}\left(\frac{\pi}{3}\right)\right)^7} = \operatorname{cis}\left(\frac{7\pi}{4}\right) \left(\operatorname{cis}\left(\frac{\pi}{3}\right)\right)^{-7}$$

$$= \operatorname{cis}\left(\frac{7\pi}{4}\right) \operatorname{cis}\left(\frac{-7\pi}{3}\right)$$

$$= \operatorname{cis}\left(\frac{7\pi}{4} - \frac{7\pi}{3}\right)$$

$$= \operatorname{cis}\left(\frac{-7\pi}{12}\right)$$



Example 17

Simplify $\frac{(1+i)^3}{(1-\sqrt{3}i)^5}$.

Solution

First convert to polar form:

$$1+i = \sqrt{2} \operatorname{cis}\left(\frac{\pi}{4}\right)$$

$$1-\sqrt{3}i = 2 \operatorname{cis}\left(\frac{-\pi}{3}\right)$$

Therefore

$$\begin{aligned} \frac{(1+i)^3}{(1-\sqrt{3}i)^5} &= \frac{\left(\sqrt{2} \operatorname{cis}\left(\frac{\pi}{4}\right)\right)^3}{\left(2 \operatorname{cis}\left(\frac{-\pi}{3}\right)\right)^5} \\ &= \frac{2\sqrt{2} \operatorname{cis}\left(\frac{3\pi}{4}\right)}{32 \operatorname{cis}\left(\frac{-5\pi}{3}\right)} && \text{by De Moivre's theorem} \\ &= \frac{\sqrt{2}}{16} \operatorname{cis}\left(\frac{3\pi}{4} - \left(\frac{-5\pi}{3}\right)\right) \\ &= \frac{\sqrt{2}}{16} \operatorname{cis}\left(\frac{29\pi}{12}\right) \\ &= \frac{\sqrt{2}}{16} \operatorname{cis}\left(\frac{5\pi}{12}\right) \end{aligned}$$

Exercise 8D

Skillsheet

Example 14

1 Simplify $4 \operatorname{cis}\left(\frac{\pi}{6}\right) + 6 \operatorname{cis}\left(\frac{2\pi}{3}\right)$.

Example 15

2 Simplify each of the following:

a $4 \operatorname{cis}\left(\frac{2\pi}{3}\right) \times 3 \operatorname{cis}\left(\frac{3\pi}{4}\right)$

b $\frac{\sqrt{2} \operatorname{cis}\left(\frac{\pi}{2}\right)}{\sqrt{8} \operatorname{cis}\left(\frac{5\pi}{6}\right)}$

c $\frac{1}{2} \operatorname{cis}\left(\frac{-2\pi}{5}\right) \times \frac{7}{3} \operatorname{cis}\left(\frac{\pi}{3}\right)$

d $\frac{4 \operatorname{cis}\left(\frac{-\pi}{4}\right)}{\frac{1}{2} \operatorname{cis}\left(\frac{7\pi}{10}\right)}$

e $\frac{4 \operatorname{cis}\left(\frac{2\pi}{3}\right)}{32 \operatorname{cis}\left(\frac{-\pi}{3}\right)}$

Example 16

3 Simplify each of the following:

a $2 \operatorname{cis}\left(\frac{5\pi}{6}\right) \times \left(\sqrt{2} \operatorname{cis}\left(\frac{7\pi}{8}\right)\right)^4$

b $\frac{1}{\left(\frac{3}{2} \operatorname{cis}\left(\frac{5\pi}{8}\right)\right)^3}$

c $\left(\operatorname{cis}\left(\frac{\pi}{6}\right)\right)^8 \times \left(\sqrt{3} \operatorname{cis}\left(\frac{\pi}{4}\right)\right)^6$

d $\left(\frac{1}{2} \operatorname{cis}\left(\frac{\pi}{2}\right)\right)^{-5}$

e $\left(2 \operatorname{cis}\left(\frac{3\pi}{2}\right) \times 3 \operatorname{cis}\left(\frac{\pi}{6}\right)\right)^3$

f $\left(\frac{1}{2} \operatorname{cis}\left(\frac{\pi}{8}\right)\right)^{-6} \times \left(4 \operatorname{cis}\left(\frac{\pi}{3}\right)\right)^2$

g $\frac{\left(6 \operatorname{cis}\left(\frac{2\pi}{5}\right)\right)^3}{\left(\frac{1}{2} \operatorname{cis}\left(\frac{-\pi}{4}\right)\right)^{-5}}$

4 For each of the following, find $\operatorname{Arg}(z_1 z_2)$ and $\operatorname{Arg}(z_1) + \operatorname{Arg}(z_2)$ and comment on their relationship:

a $z_1 = \operatorname{cis}\left(\frac{\pi}{4}\right)$ and $z_2 = \operatorname{cis}\left(\frac{\pi}{3}\right)$

b $z_1 = \operatorname{cis}\left(\frac{-2\pi}{3}\right)$ and $z_2 = \operatorname{cis}\left(\frac{-3\pi}{4}\right)$

c $z_1 = \operatorname{cis}\left(\frac{2\pi}{3}\right)$ and $z_2 = \operatorname{cis}\left(\frac{\pi}{2}\right)$

5 Show that if $\frac{-\pi}{2} < \operatorname{Arg}(z_1) < \frac{\pi}{2}$ and $\frac{-\pi}{2} < \operatorname{Arg}(z_2) < \frac{\pi}{2}$, then

$$\operatorname{Arg}(z_1 z_2) = \operatorname{Arg}(z_1) + \operatorname{Arg}(z_2) \quad \text{and} \quad \operatorname{Arg}\left(\frac{z_1}{z_2}\right) = \operatorname{Arg}(z_1) - \operatorname{Arg}(z_2)$$

6 For $z = 1 + i$, find:

a $\operatorname{Arg} z$

b $\operatorname{Arg}(-z)$

c $\operatorname{Arg}\left(\frac{1}{z}\right)$

7 a Show that $\sin \theta + i \cos \theta = \operatorname{cis}\left(\frac{\pi}{2} - \theta\right)$.

b Simplify each of the following:

i $(\sin \theta + i \cos \theta)^7$

ii $(\sin \theta + i \cos \theta)(\cos \theta + i \sin \theta)$

iii $(\sin \theta + i \cos \theta)^{-4}$

iv $(\sin \theta + i \cos \theta)(\sin \varphi + i \cos \varphi)$

8 a Show that $\cos \theta - i \sin \theta = \operatorname{cis}(-\theta)$.

b Simplify each of the following:

i $(\cos \theta - i \sin \theta)^5$

ii $(\cos \theta - i \sin \theta)^{-3}$

iii $(\cos \theta - i \sin \theta)(\cos \theta + i \sin \theta)$

iv $(\cos \theta - i \sin \theta)(\sin \theta + i \cos \theta)$

9 a Show that $\sin \theta - i \cos \theta = \operatorname{cis}\left(\theta - \frac{\pi}{2}\right)$.

b Simplify each of the following:

i $(\sin \theta - i \cos \theta)^6$

ii $(\sin \theta - i \cos \theta)^{-2}$

iii $(\sin \theta - i \cos \theta)^2(\cos \theta - i \sin \theta)$

iv $\frac{\sin \theta - i \cos \theta}{\cos \theta + i \sin \theta}$

10 a Express each of the following in modulus–argument form, where $0 < \theta < \frac{\pi}{2}$:

i $1 + i \tan \theta$

ii $1 + i \cot \theta$

iii $\frac{1}{\sin \theta} + \frac{1}{\cos \theta}i$

b Hence simplify each of the following:

i $(1 + i \tan \theta)^2$

ii $(1 + i \cot \theta)^{-3}$

iii $\frac{1}{\sin \theta} - \frac{1}{\cos \theta}i$

Example 17 **11** Simplify each of the following, giving your answer in polar form $r \operatorname{cis} \theta$, with $r > 0$ and $\theta \in (-\pi, \pi]$:

a $(1 + \sqrt{3}i)^6$

b $(1 - i)^{-5}$

c $i(\sqrt{3} - i)^7$

d $(-3 + \sqrt{3}i)^{-3}$

e $\frac{(1 + \sqrt{3}i)^3}{i(1 - i)^5}$

f $\frac{(-1 + \sqrt{3}i)^4(-\sqrt{2} - \sqrt{2}i)^3}{\sqrt{3} - 3i}$



g $(-1 + i)^5 \left(\frac{1}{2} \operatorname{cis} \left(\frac{\pi}{4} \right) \right)^3$

h $\frac{\left(\operatorname{cis} \left(\frac{2\pi}{5} \right) \right)^3}{(1 - \sqrt{3}i)^2}$

i $\left((1 - i) \operatorname{cis} \left(\frac{2\pi}{3} \right) \right)^7$

8E Solving quadratic equations over the complex numbers

► Factorisation of quadratics

Quadratic polynomials with a negative discriminant cannot be factorised over the real numbers. The introduction of complex numbers enables us to factorise such quadratics.

Sum of two squares

Since $i^2 = -1$, we can rewrite a sum of two squares as a difference of two squares:

$$\begin{aligned} z^2 + a^2 &= z^2 - (ai)^2 \\ &= (z + ai)(z - ai) \end{aligned}$$

Example 18

Factorise:

a $z^2 + 16$

b $2z^2 + 6$

Solution

a $z^2 + 16 = z^2 - 16i^2$
 $= (z + 4i)(z - 4i)$

b $2z^2 + 6 = 2(z^2 + 3)$
 $= 2(z^2 - 3i^2)$
 $= 2(z + \sqrt{3}i)(z - \sqrt{3}i)$

Note: The discriminant of $z^2 + 16$ is $\Delta = 0 - 4 \times 16 = -64$.

The discriminant of $2z^2 + 6$ is $\Delta = 0 - 4 \times 2 \times 6 = -48$.



Example 19

Factorise:

a $z^2 + z + 3$ **b** $2z^2 - z + 1$ **c** $2z^2 - 2(3 - i)z + 4 - 3i$

Solution

a Let $P(z) = z^2 + z + 3$. Then, by completing the square, we have

$$\begin{aligned} P(z) &= \left(z^2 + z + \frac{1}{4}\right) + 3 - \frac{1}{4} \\ &= \left(z + \frac{1}{2}\right)^2 + \frac{11}{4} \\ &= \left(z + \frac{1}{2}\right)^2 - \frac{11}{4}i^2 \\ &= \left(z + \frac{1}{2} + \frac{\sqrt{11}}{2}i\right)\left(z + \frac{1}{2} - \frac{\sqrt{11}}{2}i\right) \end{aligned}$$

b Let $P(z) = 2z^2 - z + 1$. Then

$$\begin{aligned} P(z) &= 2\left(z^2 - \frac{1}{2}z + \frac{1}{2}\right) \\ &= 2\left(\left(z^2 - \frac{1}{2}z + \frac{1}{16}\right) + \frac{1}{2} - \frac{1}{16}\right) \\ &= 2\left(\left(z - \frac{1}{4}\right)^2 + \frac{7}{16}\right) \\ &= 2\left(\left(z - \frac{1}{4}\right)^2 - \frac{7}{16}i^2\right) \\ &= 2\left(z - \frac{1}{4} + \frac{\sqrt{7}}{4}i\right)\left(z - \frac{1}{4} - \frac{\sqrt{7}}{4}i\right) \end{aligned}$$

c Let $P(z) = 2z^2 - 2(3 - i)z + 4 - 3i$. Then

$$\begin{aligned} P(z) &= 2\left(z^2 - (3 - i)z + \frac{4 - 3i}{2}\right) \\ &= 2\left(z^2 - (3 - i)z + \left(\frac{3 - i}{2}\right)^2 + \frac{4 - 3i}{2} - \left(\frac{3 - i}{2}\right)^2\right) \\ &= 2\left(z - \frac{3 - i}{2}\right)^2 + 4 - 3i - \frac{(3 - i)^2}{2} \\ &= 2\left(z - \frac{3 - i}{2}\right)^2 + \frac{8 - 6i - 9 + 6i + 1}{2} \\ &= 2\left(z - \frac{3 - i}{2}\right)^2 \end{aligned}$$

► Solution of quadratic equations

In the previous example, we used the method of completing the square to factorise quadratic expressions. This method can also be used to solve quadratic equations.

Alternatively, a quadratic equation of the form $az^2 + bz + c = 0$ can be solved by using the quadratic formula:

$$z = \frac{-b \pm \sqrt{b^2 - 4ac}}{2a}$$

This formula is obtained by completing the square on the expression $az^2 + bz + c$.

Example 20

Solve each of the following equations for z :

a $z^2 + z + 3 = 0$

b $2z^2 - z + 1 = 0$

c $z^2 = 2z - 5$

d $2z^2 - 2(3 - i)z + 4 - 3i = 0$

Solution

a From Example 19a:

$$z^2 + z + 3 = \left(z - \left(-\frac{1}{2} - \frac{\sqrt{11}i}{2}\right)\right)\left(z - \left(-\frac{1}{2} + \frac{\sqrt{11}i}{2}\right)\right)$$

Hence $z^2 + z + 3 = 0$ has solutions

$$z = -\frac{1}{2} - \frac{\sqrt{11}i}{2} \quad \text{and} \quad z = -\frac{1}{2} + \frac{\sqrt{11}i}{2}$$

b From Example 19b:

$$2z^2 - z + 1 = 2\left(z - \left(\frac{1}{4} - \frac{\sqrt{7}i}{4}\right)\right)\left(z - \left(\frac{1}{4} + \frac{\sqrt{7}i}{4}\right)\right)$$

Hence $2z^2 - z + 1 = 0$ has solutions

$$z = \frac{1}{4} - \frac{\sqrt{7}i}{4} \quad \text{and} \quad z = \frac{1}{4} + \frac{\sqrt{7}i}{4}$$

c Rearrange the equation into the form

$$z^2 - 2z + 5 = 0$$

Now apply the quadratic formula:

$$\begin{aligned} z &= \frac{2 \pm \sqrt{-16}}{2} \\ &= \frac{2 \pm 4i}{2} \\ &= 1 \pm 2i \end{aligned}$$

The solutions are $1 + 2i$ and $1 - 2i$.

d From Example 19c, we have

$$2z^2 - 2(3 - i)z + 4 - 3i = 2\left(z - \frac{3 - i}{2}\right)^2$$

Hence $2z^2 - 2(3 - i)z + 4 - 3i = 0$ has solution $z = \frac{3 - i}{2}$.

Note: In parts **a**, **b** and **c** of this example, the two solutions are conjugates of each other. We explore this further in the next section.

Using the TI-Nspire

To find complex solutions, use (menu) > **Algebra**
> **Complex** > **Solve** as shown.

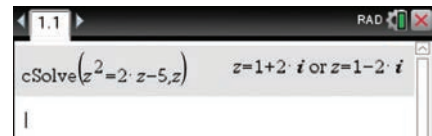

Using the Casio ClassPad

- Ensure your calculator is in complex mode.
- Enter and highlight the equation.
- Select **Interactive** > **Equation/Inequality** > **solve**.
- Ensure that the variable is z .

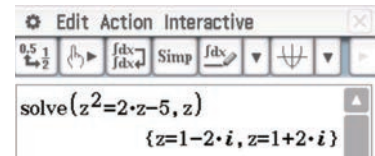

We can see that any quadratic polynomial can be factorised into linear factors over the complex numbers. In the next section, we find that any higher degree polynomial can also be factorised into linear factors over the complex numbers.

Exercise 8E

Skillsheet

1 Factorise each of the following into linear factors over \mathbb{C} :

a $z^2 + 16$

b $z^2 + 5$

c $z^2 + 2z + 5$

d $z^2 - 3z + 4$

e $2z^2 - 8z + 9$

f $3z^2 + 6z + 4$

g $3z^2 + 2z + 2$

h $2z^2 - z + 3$

Example 20

2 Solve each of the following equations over \mathbb{C} :

a $x^2 + 25 = 0$

b $x^2 + 8 = 0$

c $x^2 - 4x + 5 = 0$

d $3x^2 + 7x + 5 = 0$

e $x^2 = 2x - 3$

f $5x^2 + 1 = 3x$

g $z^2 + (1 + 2i)z + (-1 + i) = 0$

h $z^2 + z + (1 - i) = 0$

Hint: Show that $-3 + 4i = (1 + 2i)^2$.



8F Solving polynomial equations over the complex numbers

You have studied polynomials over the real numbers in Mathematical Methods. We now extend this study to polynomials over the complex numbers.

For $n \in \mathbb{N} \cup \{0\}$, a polynomial of degree n is an expression of the form

$$P(z) = a_n z^n + a_{n-1} z^{n-1} + \cdots + a_1 z + a_0$$

where the coefficients a_i are complex numbers and $a_n \neq 0$.

When we divide the polynomial $P(z)$ by the polynomial $D(z)$ we obtain two polynomials, $Q(z)$ the **quotient** and $R(z)$ the **remainder**, such that

$$P(z) = D(z)Q(z) + R(z)$$

and either $R(z) = 0$ or $R(z)$ has degree less than $D(z)$.

If $R(z) = 0$, then $D(z)$ is a **factor** of $P(z)$.

The remainder theorem and the factor theorem are true for polynomials over \mathbb{C} .

Remainder theorem

Let $\alpha \in \mathbb{C}$. When a polynomial $P(z)$ is divided by $z - \alpha$, the remainder is $P(\alpha)$.

Proof Dividing the polynomial $P(z)$ by $z - \alpha$, we can write

$$P(z) = (z - \alpha)Q(z) + R$$

where $Q(z)$ is the quotient and R is the remainder, with $R \in \mathbb{C}$. Therefore

$$P(\alpha) = (\alpha - \alpha)Q(\alpha) + R = R$$

and so the remainder is $R = P(\alpha)$.

Factor theorem

Let $\alpha \in \mathbb{C}$. Then $z - \alpha$ is a factor of a polynomial $P(z)$ if and only if $P(\alpha) = 0$.

Proof This theorem follows straight from the remainder theorem, since $z - \alpha$ is a factor of $P(z)$ if and only if the remainder is zero when $P(z)$ is divided by $z - \alpha$.

Example 21

Factorise $P(z) = z^3 + z^2 + 4$.

Solution

Use the factor theorem to find the first factor:

$$P(-1) = -1 + 1 + 4 \neq 0$$

$$P(-2) = -8 + 4 + 4 = 0$$

Therefore $z + 2$ is a factor. By division, we obtain

$$P(z) = (z + 2)(z^2 - z + 2)$$

We can factorise $z^2 - z + 2$ by completing the square:

$$\begin{aligned} z^2 - z + 2 &= \left(z^2 - z + \frac{1}{4}\right) + 2 - \frac{1}{4} \\ &= \left(z - \frac{1}{2}\right)^2 - \frac{7}{4}i^2 \\ &= \left(z - \frac{1}{2} + \frac{\sqrt{7}}{2}i\right)\left(z - \frac{1}{2} - \frac{\sqrt{7}}{2}i\right) \end{aligned}$$

Hence $P(z) = (z + 2)\left(z - \frac{1}{2} + \frac{\sqrt{7}}{2}i\right)\left(z - \frac{1}{2} - \frac{\sqrt{7}}{2}i\right)$

Example 22

Factorise $z^3 - iz^2 - 4z + 4i$.

Solution

Factorise by grouping:

$$\begin{aligned} z^3 - iz^2 - 4z + 4i &= z^2(z - i) - 4(z - i) \\ &= (z - i)(z^2 - 4) \\ &= (z - i)(z - 2)(z + 2) \end{aligned}$$

► The conjugate root theorem

We have seen in the examples in this section and the previous section that, for polynomial equations with real coefficients, there are solutions which are conjugates.

Conjugate root theorem

Let $P(z)$ be a polynomial with real coefficients. If $a + bi$ is a solution of the equation $P(z) = 0$, with a and b real numbers, then the complex conjugate $a - bi$ is also a solution.

Proof We will prove the theorem for quadratics, as it gives the idea of the general proof.

Let $P(z) = az^2 + bz + c$, where $a, b, c \in \mathbb{R}$ and $a \neq 0$. Assume that α is a solution of the equation $P(z) = 0$. Then $P(\alpha) = 0$. That is,

$$a\alpha^2 + b\alpha + c = 0$$

Take the conjugate of both sides of this equation and use properties of conjugates:

$$\overline{a\alpha^2 + b\alpha + c} = \bar{0}$$

$$\overline{a\alpha^2} + \overline{b\alpha} + \bar{c} = 0$$

$$a(\overline{\alpha^2}) + b\bar{\alpha} + c = 0 \quad \text{since } a, b \text{ and } c \text{ are real numbers}$$

$$a(\bar{\alpha})^2 + b\bar{\alpha} + c = 0$$

Hence $P(\bar{\alpha}) = 0$. That is, $\bar{\alpha}$ is a solution of the equation $P(z) = 0$.

If a polynomial $P(z)$ has real coefficients, then using this theorem we can say that the complex solutions of the equation $P(z) = 0$ occur in **conjugate pairs**.

► Factorisation of cubic polynomials

Over the complex numbers, every cubic polynomial has three linear factors.

If the coefficients of the cubic are real, then at least one factor must be real (as complex factors occur in pairs). The usual method of solution, already demonstrated in Example 21, is to find the real linear factor using the factor theorem and then complete the square on the resulting quadratic factor. The cubic polynomial can also be factorised if one complex root is given, as shown in the next example.



Example 23

Let $P(z) = z^3 - 3z^2 + 5z - 3$.

- Use the factor theorem to show that $z - 1 + \sqrt{2}i$ is a factor of $P(z)$.
- Find the other linear factors of $P(z)$.

Solution

- To show that $z - (1 - \sqrt{2}i)$ is a factor, we must check that $P(1 - \sqrt{2}i) = 0$.

We have

$$P(1 - \sqrt{2}i) = (1 - \sqrt{2}i)^3 - 3(1 - \sqrt{2}i)^2 + 5(1 - \sqrt{2}i) - 3 = 0$$

Therefore $z - (1 - \sqrt{2}i)$ is a factor of $P(z)$.

- Since the coefficients of $P(z)$ are real, the complex linear factors occur in conjugate pairs, so $z - (1 + \sqrt{2}i)$ is also a factor.

To find the third linear factor, first multiply the two complex factors together:

$$\begin{aligned} & (z - (1 - \sqrt{2}i))(z - (1 + \sqrt{2}i)) \\ &= z^2 - (1 - \sqrt{2}i)z - (1 + \sqrt{2}i)z + (1 - \sqrt{2}i)(1 + \sqrt{2}i) \\ &= z^2 - (1 - \sqrt{2}i + 1 + \sqrt{2}i)z + 1 + 2 \\ &= z^2 - 2z + 3 \end{aligned}$$

Therefore, by inspection, the linear factors of $P(z) = z^3 - 3z^2 + 5z - 3$ are

$$z - 1 + \sqrt{2}i, \quad z - 1 - \sqrt{2}i \quad \text{and} \quad z - 1$$

► Factorisation of higher degree polynomials

Polynomials of the form $z^4 - a^4$ and $z^6 - a^6$ are considered in the following two examples.

Example 24

Factorise $z^4 - 16$ over \mathbb{C} .

Solution

$$\begin{aligned} z^4 - 16 &= (z^2 + 4)(z^2 - 4) && \text{difference of two squares} \\ &= (z + 2i)(z - 2i)(z + 2)(z - 2) \end{aligned}$$

Example 25Factorise $z^6 - 1$ over \mathbb{C} .**Solution**

First note that

$$z^6 - 1 = (z^3 + 1)(z^3 - 1)$$

We next factorise $z^3 + 1$ and $z^3 - 1$.

We have

$$\begin{aligned} z^3 + 1 &= (z + 1)(z^2 - z + 1) \\ &= (z + 1) \left(\left(z^2 - z + \frac{1}{4} \right) + 1 - \frac{1}{4} \right) \\ &= (z + 1) \left(\left(z - \frac{1}{2} \right)^2 - \frac{3}{4}i^2 \right) \\ &= (z + 1) \left(z - \frac{1}{2} + \frac{\sqrt{3}}{2}i \right) \left(z - \frac{1}{2} - \frac{\sqrt{3}}{2}i \right) \end{aligned}$$

and, similarly, we have

$$\begin{aligned} z^3 - 1 &= (z - 1)(z^2 + z + 1) \\ &= (z - 1) \left(\left(z^2 + z + \frac{1}{4} \right) + 1 - \frac{1}{4} \right) \\ &= (z - 1) \left(\left(z + \frac{1}{2} \right)^2 - \frac{3}{4}i^2 \right) \\ &= (z - 1) \left(z + \frac{1}{2} + \frac{\sqrt{3}}{2}i \right) \left(z + \frac{1}{2} - \frac{\sqrt{3}}{2}i \right) \end{aligned}$$

Therefore

$$\begin{aligned} z^6 - 1 &= (z^3 + 1)(z^3 - 1) \\ &= (z + 1)(z - 1) \left(z - \frac{1}{2} + \frac{\sqrt{3}}{2}i \right) \left(z - \frac{1}{2} - \frac{\sqrt{3}}{2}i \right) \left(z + \frac{1}{2} + \frac{\sqrt{3}}{2}i \right) \left(z + \frac{1}{2} - \frac{\sqrt{3}}{2}i \right) \end{aligned}$$

Using the TI-NspireTo find complex factors, use $\boxed{\text{menu}}$ > **Algebra** > **Complex** > **Factor**.

The first operation shown factorises to give integer coefficients, and the second fully factorises over the complex numbers.

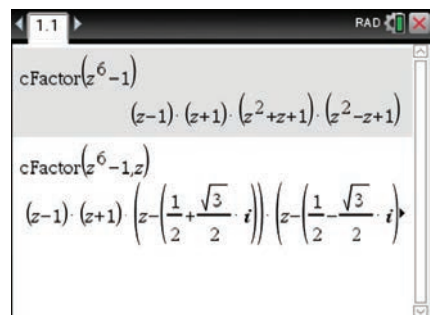

Using the Casio ClassPad

- Ensure your calculator is in complex mode.
- To factorise over the real numbers:
Enter and highlight $z^6 - 1$. Select **Interactive** > **Transformation** > **factor**.
- To factorise over the complex numbers:
Enter and highlight $z^6 - 1$. Select **Interactive** > **Transformation** > **factor** > **rFactor**.

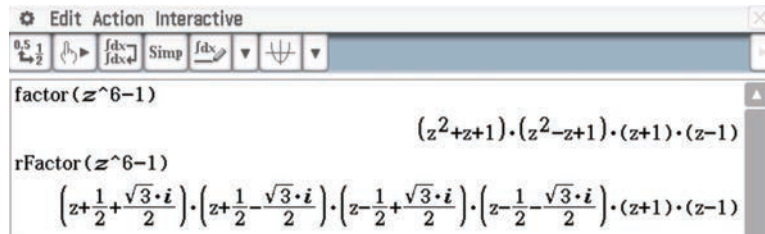

Note: Go to **Edit** > **Clear all variables** if z has been used to store a complex expression.

► The fundamental theorem of algebra

The following important theorem has been attributed to Gauss (1799).

Fundamental theorem of algebra

Every polynomial $P(z) = a_n z^n + a_{n-1} z^{n-1} + \dots + a_1 z + a_0$ of degree n , where $n \geq 1$ and the coefficients a_i are complex numbers, has at least one linear factor in the complex number system.

Given any polynomial $P(z)$ of degree $n \geq 1$, the theorem tells us that we can factorise $P(z)$ as

$$P(z) = (z - \alpha_1)Q(z)$$

for some $\alpha_1 \in \mathbb{C}$ and some polynomial $Q(z)$ of degree $n - 1$.

By applying the fundamental theorem of algebra repeatedly, it can be shown that:

A polynomial of degree n can be factorised into n linear factors in \mathbb{C} :

$$\text{i.e. } P(z) = a_n(z - \alpha_1)(z - \alpha_2)(z - \alpha_3) \dots (z - \alpha_n), \text{ where } \alpha_1, \alpha_2, \alpha_3, \dots, \alpha_n \in \mathbb{C}$$

A polynomial equation can be solved by first rearranging it into the form $P(z) = 0$, where $P(z)$ is a polynomial, and then factorising $P(z)$ and extracting a solution from each factor.

If $P(z) = (z - \alpha_1)(z - \alpha_2) \dots (z - \alpha_n)$, then the solutions of $P(z) = 0$ are $\alpha_1, \alpha_2, \dots, \alpha_n$.

The solutions of the equation $P(z) = 0$ are also referred to as the **zeroes** or the **roots** of the polynomial $P(z)$.

Example 26

Solve each of the following equations over \mathbb{C} :

a $z^2 + 64 = 0$

b $z^3 + 3z^2 + 7z + 5 = 0$

c $z^3 - iz^2 - 4z + 4i = 0$

Solution

a $z^2 + 64 = 0$

$$(z + 8i)(z - 8i) = 0$$

$$\therefore z = -8i \text{ or } z = 8i$$

b Let $P(z) = z^3 + 3z^2 + 7z + 5$.

Then $P(-1) = 0$, so $z + 1$ is a factor, by the factor theorem.

$$\begin{aligned} P(z) &= (z + 1)(z^2 + 2z + 5) \\ &= (z + 1)(z^2 + 2z + 1 + 4) \\ &= (z + 1)((z + 1)^2 - (2i)^2) \\ &= (z + 1)(z + 1 - 2i)(z + 1 + 2i) \end{aligned}$$

If $P(z) = 0$, then $z = -1$, $z = -1 + 2i$ or $z = -1 - 2i$.

c $z^3 - iz^2 - 4z + 4i = 0$

$$(z - i)(z - 2)(z + 2) = 0 \quad (\text{from Example 22})$$

$$\therefore z = i, z = 2 \text{ or } z = -2$$

Exercise 8F

Skillsheet

1 Factorise each of the following polynomials into linear factors over \mathbb{C} :

a $z^3 - 4z^2 - 4z - 5$

b $z^3 - z^2 - z + 10$

c $3z^3 - 13z^2 + 5z - 4$

d $2z^3 + 3z^2 - 4z + 15$

e $z^3 - (2 - i)z^2 + z - 2 + i$

Example 23

2 Let $P(z) = z^3 + 4z^2 - 10z + 12$.

a Use the factor theorem to show that $z - 1 - i$ is a linear factor of $P(z)$.

b Write down another complex linear factor of $P(z)$.

c Hence find all the linear factors of $P(z)$ over \mathbb{C} .

3 Let $P(z) = 2z^3 + 9z^2 + 14z + 5$.

a Use the factor theorem to show that $z + 2 - i$ is a linear factor of $P(z)$.

b Write down another complex linear factor of $P(z)$.

c Hence find all the linear factors of $P(z)$ over \mathbb{C} .

4 Let $P(z) = z^4 + 8z^2 + 16z + 20$.

a Use the factor theorem to show that $z - 1 + 3i$ is a linear factor of $P(z)$.

b Write down another complex linear factor of $P(z)$.

c Hence find all the linear factors of $P(z)$ over \mathbb{C} .

Example 24, 25

5 Factorise each of the following into linear factors over \mathbb{C} :

a $z^4 - 81$

b $z^6 - 64$

6 For each of the following, factorise the first expression into linear factors over \mathbb{C} , given that the second expression is one of the linear factors:

a $z^3 + (1 - i)z^2 + (1 - i)z - i, \quad z - i$

b $z^3 - (2 - i)z^2 - (1 + 2i)z - i, \quad z + i$

c $z^3 - (2 + 2i)z^2 - (3 - 4i)z + 6i, \quad z - 2i$

d $2z^3 + (1 - 2i)z^2 - (5 + i)z + 5i, \quad z - i$

7 For each of the following, find the value of p given that:

a $z + 2$ is a factor of $z^3 + 3z^2 + pz + 12$

b $z - i$ is a factor of $z^3 + pz^2 + z - 4$

c $z + 1 - i$ is a factor of $2z^3 + z^2 - 2z + p$

Example 26

8 Solve each of the following equations over \mathbb{C} :

a $x^3 + x^2 - 6x - 18 = 0$

b $x^3 - 6x^2 + 11x - 30 = 0$

c $2x^3 + 3x^2 = 11x^2 - 6x - 16$

d $x^4 + x^2 = 2x^3 + 36$

9 Let $z^2 + az + b = 0$, where $a, b \in \mathbb{R}$. Find a and b if one of the solutions is:

a $2i$

b $3 + 2i$

c $-1 + 3i$

10 a $1 + 3i$ is a solution of the equation $3z^3 - 7z^2 + 32z - 10 = 0$. Find the other solutions.

b $-2 - i$ is a solution of the equation $z^4 - 5z^2 + 4z + 30 = 0$. Find the other solutions.

11 For a cubic polynomial $P(x)$ with real coefficients, $P(2 + i) = 0$, $P(1) = 0$ and $P(0) = 10$. Express $P(x)$ in the form $P(x) = ax^3 + bx^2 + cx + d$ and solve the equation $P(x) = 0$.

12 If $z = 1 + i$ is a zero of the polynomial $z^3 + az^2 + bz + 10 - 6i$, find the constants a and b , given that they are real.

13 The polynomial $P(z) = 2z^3 + az^2 + bz + 5$, where a and b are real numbers, has $2 - i$ as one of its zeroes.

a Find a quadratic factor of $P(z)$, and hence calculate the real constants a and b .

b Determine the solutions to the equation $P(z) = 0$.

14 For the polynomial $P(z) = az^4 + az^2 - 2z + d$, where a and d are real numbers:

a Evaluate $P(1 + i)$.

b Given that $P(1 + i) = 0$, find the values of a and d .

c Show that $P(z)$ can be written as the product of two quadratic factors with real coefficients, and hence solve the equation $P(z) = 0$.

15 The solutions of the quadratic equation $z^2 + pz + q = 0$ are $1 + i$ and $4 + 3i$. Find the complex numbers p and q .

16 Given that $1 - i$ is a solution of $z^3 - 4z^2 + 6z - 4 = 0$, find the other two solutions.

17 Solve each of the following for z :

a $z^2 - (6 + 2i)z + (8 + 6i) = 0$

b $z^3 - 2iz^2 - 6z + 12i = 0$

c $z^3 - z^2 + 6z - 6 = 0$

d $z^3 - z^2 + 2z - 8 = 0$

e $6z^2 - 3\sqrt{2}z + 6 = 0$

f $z^3 + 2z^2 + 9z = 0$



8G Using De Moivre's theorem to solve equations

Equations of the form $z^n = a$, where $a \in \mathbb{C}$, are often solved by using De Moivre's theorem.

Write both z and a in polar form, as $z = r \operatorname{cis} \theta$ and $a = r_1 \operatorname{cis} \varphi$.

Then $z^n = a$ becomes

$$(r \operatorname{cis} \theta)^n = r_1 \operatorname{cis} \varphi$$

$$\therefore r^n \operatorname{cis}(n\theta) = r_1 \operatorname{cis} \varphi \quad (\text{using De Moivre's theorem})$$

Compare modulus and argument:

$$r^n = r_1 \quad \operatorname{cis}(n\theta) = \operatorname{cis} \varphi$$

$$r = \sqrt[n]{r_1} \quad n\theta = \varphi + 2k\pi \quad \text{where } k \in \mathbb{Z}$$

$$\theta = \frac{1}{n}(\varphi + 2k\pi) \quad \text{where } k \in \mathbb{Z}$$

This will provide all the solutions of the equation.



Example 27

Solve $z^3 = 1$.

Solution

Let $z = r \operatorname{cis} \theta$. Then

$$(r \operatorname{cis} \theta)^3 = 1 \operatorname{cis} 0$$

$$\therefore r^3 \operatorname{cis}(3\theta) = 1 \operatorname{cis} 0$$

$$\therefore r^3 = 1 \quad \text{and} \quad 3\theta = 0 + 2k\pi \quad \text{where } k \in \mathbb{Z}$$

$$\therefore r = 1 \quad \text{and} \quad \theta = \frac{2k\pi}{3} \quad \text{where } k \in \mathbb{Z}$$

Hence the solutions are of the form $z = \operatorname{cis}\left(\frac{2k\pi}{3}\right)$, where $k \in \mathbb{Z}$.

We start finding solutions.

$$\text{For } k = 0: \quad z = \operatorname{cis} 0 = 1$$

$$\text{For } k = 1: \quad z = \operatorname{cis}\left(\frac{2\pi}{3}\right)$$

$$\text{For } k = 2: \quad z = \operatorname{cis}\left(\frac{4\pi}{3}\right) = \operatorname{cis}\left(-\frac{2\pi}{3}\right)$$

$$\text{For } k = 3: \quad z = \operatorname{cis}(2\pi) = 1$$

The solutions begin to repeat.

The three solutions are 1 , $\operatorname{cis}\left(\frac{2\pi}{3}\right)$ and $\operatorname{cis}\left(-\frac{2\pi}{3}\right)$.

The solutions are shown to lie on the unit circle at intervals of $\frac{2\pi}{3}$ around the circle.

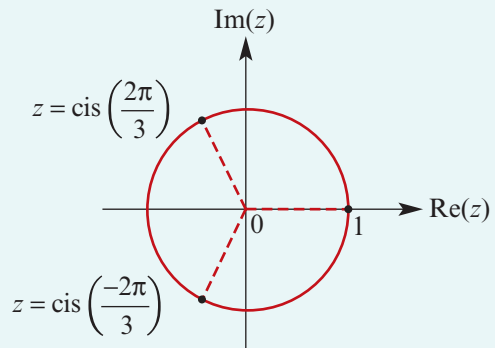

Note: An equation of the form $z^3 = a$, where $a \in \mathbb{R}$, has three solutions. Since $a \in \mathbb{R}$, two of the solutions will be conjugate to each other and the third must be a real number.

In Example 27, we found the three cube roots of the number 1:

$$1, \quad w = \operatorname{cis}\left(\frac{2\pi}{3}\right) = -\frac{1}{2} + \frac{\sqrt{3}}{2}i \quad \text{and} \quad w^2 = \operatorname{cis}\left(-\frac{2\pi}{3}\right) = -\frac{1}{2} - \frac{\sqrt{3}}{2}i$$

More generally:

Solutions of $z^n = 1$

For $n \in \mathbb{N}$, the solutions of the equation $z^n = 1$ are called the **n th roots of unity**.

- The solutions of $z^n = 1$ lie on the unit circle.
- There are n solutions and they are equally spaced around the circle at intervals of $\frac{2\pi}{n}$.
This observation can be used to find all solutions, since $z = 1$ is one solution.

Example 28

Solve $z^2 = 1 + i$.

Solution

Let $z = r \operatorname{cis} \theta$. Note that $1 + i = \sqrt{2} \operatorname{cis}\left(\frac{\pi}{4}\right)$.

$$(r \operatorname{cis} \theta)^2 = \sqrt{2} \operatorname{cis}\left(\frac{\pi}{4}\right)$$

$$\therefore r^2 \operatorname{cis}(2\theta) = 2^{\frac{1}{2}} \operatorname{cis}\left(\frac{\pi}{4}\right)$$

$$\therefore r = 2^{\frac{1}{4}} \quad \text{and} \quad 2\theta = \frac{\pi}{4} + 2k\pi \quad \text{where } k \in \mathbb{Z}$$

$$\therefore r = 2^{\frac{1}{4}} \quad \text{and} \quad \theta = \frac{\pi}{8} + k\pi \quad \text{where } k \in \mathbb{Z}$$

Hence $z = 2^{\frac{1}{4}} \operatorname{cis}\left(\frac{\pi}{8} + k\pi\right)$, where $k \in \mathbb{Z}$.

$$\text{For } k = 0: \quad z = 2^{\frac{1}{4}} \operatorname{cis}\left(\frac{\pi}{8}\right)$$

$$\begin{aligned} \text{For } k = 1: \quad z &= 2^{\frac{1}{4}} \operatorname{cis}\left(\frac{9\pi}{8}\right) \\ &= 2^{\frac{1}{4}} \operatorname{cis}\left(-\frac{7\pi}{8}\right) \end{aligned}$$

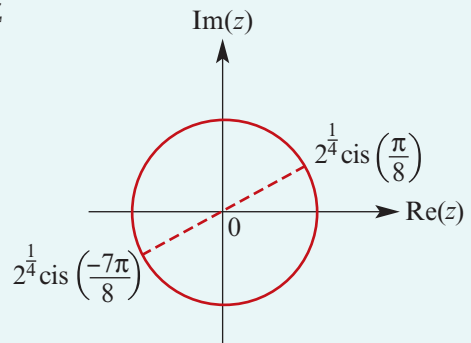

Note: If z_1 is a solution of $z^2 = a$, where $a \in \mathbb{C}$, then the other solution is $z_2 = -z_1$.

In Example 28, we found the two square roots of the complex number $1 + i$. More generally:

Solutions of $z^n = a$

For $n \in \mathbb{N}$ and $a \in \mathbb{C}$, the solutions of the equation $z^n = a$ are called the **n th roots of a** .

- The solutions of $z^n = a$ lie on a circle with centre the origin and radius $|a|^{\frac{1}{n}}$.
- There are n solutions and they are equally spaced around the circle at intervals of $\frac{2\pi}{n}$.
This observation can be used to find all solutions if one is known.

The following example shows an alternative method for solving equations of the form $z^2 = a$, where $a \in \mathbb{C}$.

Example 29

Solve $z^2 = 5 + 12i$ using $z = a + bi$, where $a, b \in \mathbb{R}$. Hence factorise $z^2 - 5 - 12i$.

Solution

$$\begin{aligned} \text{Let } z = a + bi. \text{ Then } z^2 &= (a + bi)^2 \\ &= a^2 + 2abi + b^2i^2 \\ &= (a^2 - b^2) + 2abi \end{aligned}$$

So $z^2 = 5 + 12i$ becomes

$$(a^2 - b^2) + 2abi = 5 + 12i$$

Equating coefficients:

$$a^2 - b^2 = 5 \quad \text{and} \quad 2ab = 12$$

$$a^2 - \left(\frac{6}{a}\right)^2 = 5 \quad b = \frac{6}{a}$$

$$a^2 - \frac{36}{a^2} = 5$$

$$a^4 - 36 = 5a^2$$

$$a^4 - 5a^2 - 36 = 0$$

$$(a^2 - 9)(a^2 + 4) = 0$$

$$a^2 - 9 = 0$$

$$(a + 3)(a - 3) = 0$$

$$\therefore a = -3 \text{ or } a = 3$$

When $a = -3$, $b = -2$ and when $a = 3$, $b = 2$.

So the solutions to the equation $z^2 = 5 + 12i$ are $z = -3 - 2i$ and $z = 3 + 2i$.

Hence $z^2 - 5 - 12i = (z + 3 + 2i)(z - 3 - 2i)$.

Exercise 8G

Skillsheet

Example 27, 28

1 For each of the following, solve the equation over \mathbb{C} and show the solutions on an Argand diagram:

a $z^2 + 1 = 0$

b $z^3 = 27i$

c $z^2 = 1 + \sqrt{3}i$

d $z^2 = 1 - \sqrt{3}i$

e $z^3 = i$

f $z^3 + i = 0$

2 Find all the cube roots of the following complex numbers:

a $4\sqrt{2} - 4\sqrt{2}i$

b $-4\sqrt{2} + 4\sqrt{2}i$

c $-4\sqrt{3} - 4i$

d $4\sqrt{3} - 4i$

e $-125i$

f $-1 + i$

Example 29

- 3** Let $z = a + bi$ such that $z^2 = 3 + 4i$, where $a, b \in \mathbb{R}$.
- a** Find equations in terms of a and b by equating real and imaginary parts.
b Find the values of a and b and hence find the square roots of $3 + 4i$.
- 4** Using the method of Question 3, find the square roots of each of the following:
a $-15 - 8i$ **b** $24 + 7i$ **c** $-3 + 4i$ **d** $-7 + 24i$
- 5** Find the solutions of the equation $z^4 - 2z^2 + 4 = 0$ in polar form.
- 6** Find the solutions of the equation $z^2 - i = 0$ in Cartesian form. Hence factorise $z^2 - i$.
- 7** Find the solutions of the equation $z^8 + 1 = 0$ in polar form. Hence factorise $z^8 + 1$.
- 8 a** Find the square roots of $1 + i$ by using:
i Cartesian methods **ii** De Moivre's theorem.
b Hence find exact values of $\cos\left(\frac{\pi}{8}\right)$ and $\sin\left(\frac{\pi}{8}\right)$.



8H Sketching subsets of the complex plane



Particular sets of points of the complex plane can be described by placing restrictions on z . For example:

- $\{z : \operatorname{Re}(z) = 6\}$ is the straight line parallel to the imaginary axis with each point on the line having real part 6.
- $\{z : \operatorname{Im}(z) = 2 \operatorname{Re}(z)\}$ is the straight line through the origin with gradient 2.

The set of all points which satisfy a given condition is called the **locus** of the condition (plural loci). When sketching a locus, a solid line is used for a boundary which is included in the locus, and a dashed line is used for a boundary which is not included.

Example 30

On an Argand diagram, sketch the subset S of the complex plane, where

$$S = \{z : |z - 1| = 2\}$$

Solution

Method 1 (algebraic)

Let $z = x + yi$. Then

$$|z - 1| = 2$$

$$|x + yi - 1| = 2$$

$$|(x - 1) + yi| = 2$$

$$\sqrt{(x - 1)^2 + y^2} = 2$$

$$\therefore (x - 1)^2 + y^2 = 4$$

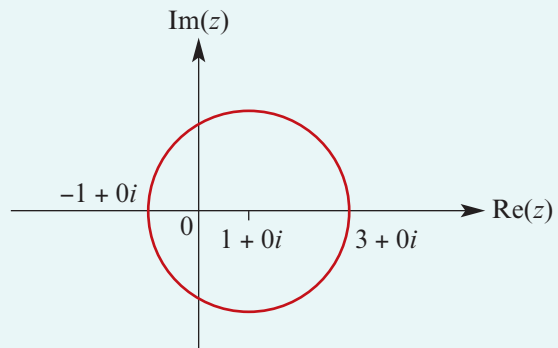

This demonstrates that S is represented by the circle with centre $1 + 0i$ and radius 2.

Method 2 (geometric)

If z_1 and z_2 are complex numbers, then $|z_1 - z_2|$ is the distance between the points on the complex plane corresponding to z_1 and z_2 .

Hence $\{z : |z - 1| = 2\}$ is the set of all points that are distance 2 from $1 + 0i$. That is, the set S is represented by the circle with centre $1 + 0i$ and radius 2.

Example 31

On an Argand diagram, sketch the subset S of the complex plane, where

$$S = \{z : |z - 2| = |z - (1 + i)|\}$$

Solution**Method 1 (algebraic)**

Let $z = x + yi$. Then

$$|z - 2| = |z - (1 + i)|$$

$$|x + yi - 2| = |x + yi - (1 + i)|$$

$$|x - 2 + yi| = |x - 1 + (y - 1)i|$$

$$\therefore \sqrt{(x - 2)^2 + y^2} = \sqrt{(x - 1)^2 + (y - 1)^2}$$

Squaring both sides of the equation and expanding:

$$x^2 - 4x + 4 + y^2 = x^2 - 2x + 1 + y^2 - 2y + 1$$

$$-4x + 4 = -2x - 2y + 2$$

$$\therefore y = x - 1$$

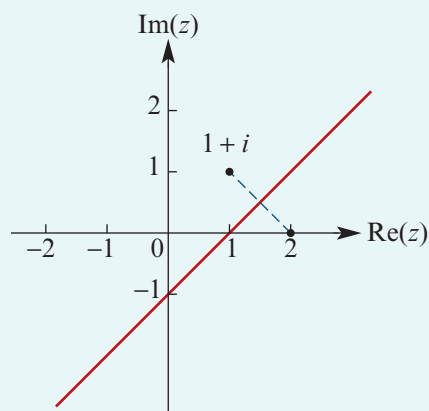
**Method 2 (geometric)**

The set S consists of all points in the complex plane that are equidistant from 2 and $1 + i$.

In the Cartesian plane, this set corresponds to the perpendicular bisector of the line segment joining $(2, 0)$ and $(1, 1)$. The midpoint of the line segment is $(\frac{3}{2}, \frac{1}{2})$, and the gradient of the line segment is -1 .

Therefore the equation of the perpendicular bisector is

$$y - \frac{1}{2} = 1(x - \frac{3}{2})$$

which simplifies to $y = x - 1$.

Example 32

Sketch the subset of the complex plane defined by each of the following conditions:

a $\text{Arg}(z) = \frac{\pi}{3}$

b $\text{Arg}(z + 3) = -\frac{\pi}{3}$

c $\text{Arg}(z) \leq \frac{\pi}{3}$

Solution

a $\text{Arg}(z) = \frac{\pi}{3}$ defines a ray or a half line.

Note: The origin is not included.

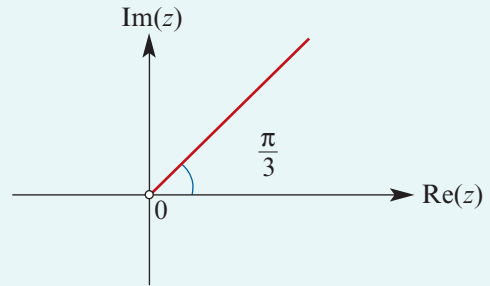

b First draw the graph of $\text{Arg}(z) = -\frac{\pi}{3}$.

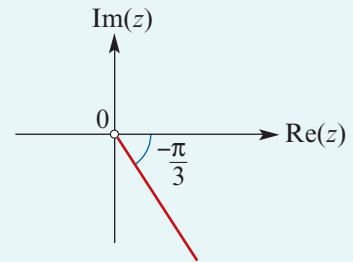

The graph of $\text{Arg}(z + 3) = -\frac{\pi}{3}$ is obtained by a translation of 3 units to the left.

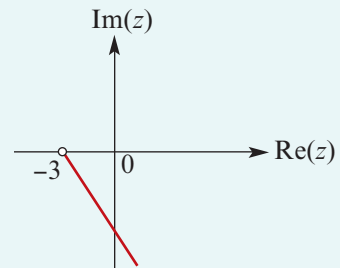

c Since $-\pi < \text{Arg}(z) \leq \pi$ in general, the condition $\text{Arg}(z) \leq \frac{\pi}{3}$ implies $-\pi < \text{Arg}(z) \leq \frac{\pi}{3}$.

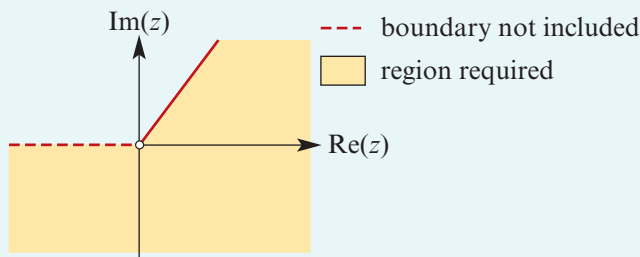

Example 33

Sketch the region corresponding to each of the following:

a $|z - (2 - i)| \leq 3$

b $\{z : 2 < |z| \leq 4\} \cap \left\{z : \frac{\pi}{6} < \text{Arg}(z) \leq \frac{\pi}{3}\right\}$

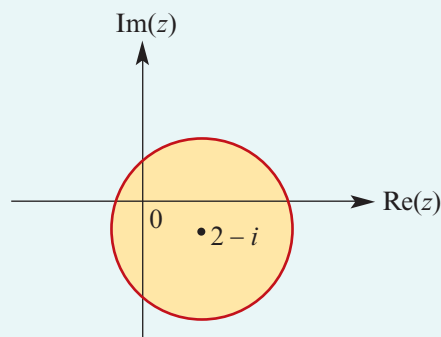
Solution**a**

Region required

The condition defines a disc of radius 3 and centre $2 - i$. The Cartesian relation is $\{(x, y) : (x - 2)^2 + (y + 1)^2 \leq 3^2\}$.

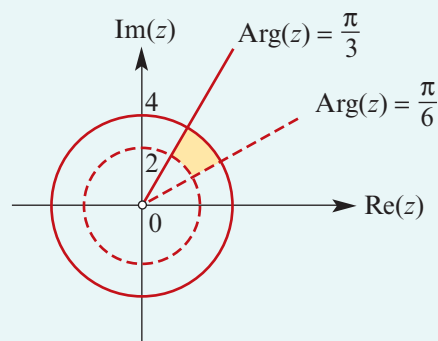
b

Region required

Example 34

Describe the locus defined by $|z + 3| = 2|z - i|$.

Solution

Let $z = x + yi$. Then

$$|z + 3| = 2|z - i|$$

$$|(x + 3) + yi| = 2|x + (y - 1)i|$$

$$\therefore \sqrt{(x + 3)^2 + y^2} = 2\sqrt{x^2 + (y - 1)^2}$$

Squaring both sides gives

$$x^2 + 6x + 9 + y^2 = 4(x^2 + y^2 - 2y + 1)$$

$$0 = 3x^2 + 3y^2 - 6x - 8y - 5$$

$$5 = 3(x^2 - 2x) + 3\left(y^2 - \frac{8}{3}y\right)$$

$$\frac{5}{3} = (x^2 - 2x + 1) + \left(y^2 - \frac{8}{3}y + \frac{16}{9}\right) - \frac{25}{9}$$

$$\therefore \frac{40}{9} = (x - 1)^2 + \left(y - \frac{4}{3}\right)^2$$

The locus is the circle with centre $1 + \frac{4}{3}i$ and radius $\frac{2\sqrt{10}}{3}$.

Note: For $a, b \in \mathbb{C}$ and $k \in \mathbb{R}^+ \setminus \{1\}$, the equation $|z - a| = k|z - b|$ defines a circle.

Example 35

Describe the locus defined by $|z - 2| - |z + 2| = 3$.

Solution

Let $z = x + yi$. Then

$$|z - 2| - |z + 2| = 3$$

$$|x + yi - 2| - |x + yi + 2| = 3$$

$$\sqrt{(x - 2)^2 + y^2} - \sqrt{(x + 2)^2 + y^2} = 3$$

$$\therefore \sqrt{(x - 2)^2 + y^2} = 3 + \sqrt{(x + 2)^2 + y^2}$$

Square both sides:

$$(x - 2)^2 + y^2 = 9 + 6\sqrt{(x + 2)^2 + y^2} + (x + 2)^2 + y^2$$

$$x^2 - 4x + 4 + y^2 = 9 + 6\sqrt{(x + 2)^2 + y^2} + x^2 + 4x + 4 + y^2$$

$$\therefore -8x - 9 = 6\sqrt{(x + 2)^2 + y^2}$$

Note: This implies that $-8x - 9 \geq 0$, so $x \leq -\frac{9}{8}$.

Square both sides again:

$$64x^2 + 144x + 81 = 36(x^2 + 4x + 4 + y^2)$$

$$28x^2 - 36y^2 = 63$$

$$\frac{x^2}{36} - \frac{y^2}{28} = \frac{1}{16}$$

$$\therefore \frac{x^2}{9} - \frac{y^2}{7} = \frac{1}{4}$$

This is the Cartesian equation of a hyperbola with asymptotes $y = \pm \frac{\sqrt{7}}{3}x$.

The locus is the left branch of this hyperbola, where $x \leq -\frac{3}{2}$.

Exercise 8H**Skillsheet**

1 Illustrate each of the following on an Argand diagram:

Example 30

a $2 \operatorname{Im}(z) = \operatorname{Re}(z)$

b $\operatorname{Im}(z) + \operatorname{Re}(z) = 1$

c $|z - 2| = 3$

d $|z - i| = 4$

e $|z - (1 + \sqrt{3}i)| = 2$

f $|z - (1 - i)| = 6$

2 Sketch $\{z : z = i\bar{z}\}$ in the complex plane.

Example 31

3 Describe the subset of the complex plane defined by $\{z : |z - 1| = |z + 1|\}$.

Example 32

4 Sketch the subset of the complex plane defined by each of the following conditions:

a $\operatorname{Arg}(z) = \frac{\pi}{4}$

b $\operatorname{Arg}(z - 2) = -\frac{\pi}{4}$

c $\operatorname{Arg}(z) \leq \frac{\pi}{4}$

Example 33 5 Sketch each of the following regions of the complex plane:

a $\{z : |z - 1| \leq 2\}$ **b** $\{z : 2 \leq |z| \leq 3\} \cap \left\{z : \frac{\pi}{4} < \text{Arg}(z) \leq \frac{3\pi}{4}\right\}$

6 Prove that $3|z - 1|^2 = |z + 1|^2$ if and only if $|z - 2|^2 = 3$, for any complex number z . Hence sketch the set $S = \{z : \sqrt{3}|z - 1| = |z + 1|\}$ on an Argand diagram.

Example 34 7 Sketch each of the following:

a $\{z : |z + 2i| = 2|z - i|\}$ **b** $\{z : \text{Im}(z) = -2\}$ **c** $\{z : z + \bar{z} = 5\}$
d $\{z : z\bar{z} = 5\}$ **e** $\{z : \text{Re}(z^2) = \text{Im}(z)\}$ **f** $\left\{z : \text{Arg}(z - i) = \frac{\pi}{3}\right\}$

Example 35 8 Illustrate each of the following on an Argand diagram:

a $|z - 1| + |z + 1| = 3$ **b** $|z - 6| - |z + 6| = 3$

9 Sketch each of the following:

a $\{z : |z - i| > 1\}$ **b** $\{z : |z + i| \leq 2\}$
c $\{z : \text{Re}(z) \geq 0\}$ **d** $\{z : 2\text{Re}(z) + \text{Im}(z) \leq 0\}$
e $\{z : \text{Re}(z) > 2 \text{ and } \text{Im}(z) \geq 1\}$ **f** $\{z : |z + 3| + |z - 3| = 8\}$

10 On an Argand diagram, sketch the set $S = \{z : \text{Re}(z) \leq 1\} \cap \{z : 0 \leq \text{Im}(z) \leq 3\}$.

11 Sketch the region of the complex plane for which $\text{Re}(z) \geq 0$ and $|z + 2i| \leq 1$.

12 Sketch the locus defined by $|z - 2 + 3i| \leq 2$.

13 On the Argand plane, sketch the curve defined by each of the following equations:

a $\left|\frac{z-2}{z}\right| = 1$ **b** $\left|\frac{z-1-i}{z}\right| = 1$

14 If the real part of $\frac{z+1}{z-1}$ is zero, find the locus of points representing z in the complex plane.

15 Given that z satisfies the equation $2|z - 2| = |z - 6i|$, show that z is represented by a point on a circle and find the centre and radius of the circle.

16 On an Argand diagram with origin O , the point P represents z and Q represents $\frac{1}{\bar{z}}$. Prove that O , P and Q are collinear and find the ratio $OP : OQ$ in terms of $|z|$.

17 Find the locus of points described by each of the following conditions:

a $|z - (1 + i)| = 1$ **b** $|z - 2| = |z + 2i|$ **c** $\text{Arg}(z - 1) = \frac{\pi}{2}$ **d** $\text{Arg}(z + i) = \frac{\pi}{4}$

18 Let $w = 2z$. Describe the locus of w if z describes a circle with centre $1 + 2i$ and radius 3.

19 **a** Find the solutions of the equation $z^2 + 2z + 4 = 0$.

b Show that the solutions satisfy:

i $|z| = 2$ **ii** $|z - 1| = \sqrt{7}$ **iii** $z + \bar{z} = -2$

c On a single diagram, sketch the loci defined by the equations in **b**.



Chapter summary



- The imaginary number i has the property $i^2 = -1$.
- The set of complex numbers is $\mathbb{C} = \{a + bi : a, b \in \mathbb{R}\}$.
- For a complex number $z = a + bi$:
 - the **real part** of z is $\text{Re}(z) = a$
 - the **imaginary part** of z is $\text{Im}(z) = b$.
- Complex numbers z_1 and z_2 are equal if and only if $\text{Re}(z_1) = \text{Re}(z_2)$ and $\text{Im}(z_1) = \text{Im}(z_2)$.
- An **Argand diagram** is a geometric representation of \mathbb{C} .
- The **modulus** of z , denoted by $|z|$, is the distance from the origin to the point representing z in an Argand diagram. Thus $|a + bi| = \sqrt{a^2 + b^2}$.
- The **argument** of z is an angle measured anticlockwise about the origin from the positive direction of the real axis to the line joining the origin to z .
- The **principal value** of the argument, denoted by $\text{Arg } z$, is the angle in the interval $(-\pi, \pi]$.
- The complex number $z = a + bi$ can be expressed in **polar form** as

$$z = r(\cos \theta + i \sin \theta)$$

$$= r \text{cis } \theta$$

where $r = |z| = \sqrt{a^2 + b^2}$, $\cos \theta = \frac{a}{r}$, $\sin \theta = \frac{b}{r}$.

This is also called **modulus–argument form**.

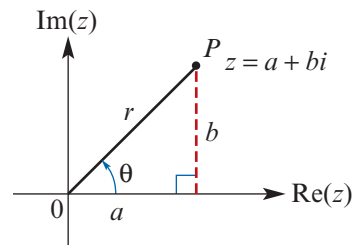

- The **complex conjugate** of z , denoted by \bar{z} , is the reflection of z in the real axis. If $z = a + bi$, then $\bar{z} = a - bi$. If $z = r \text{cis } \theta$, then $\bar{z} = r \text{cis}(-\theta)$. Note that $z\bar{z} = |z|^2$.
- Division of complex numbers:

$$\frac{z_1}{z_2} = \frac{z_1}{z_2} \times \frac{\bar{z}_2}{\bar{z}_2} = \frac{z_1 \bar{z}_2}{|z_2|^2}$$

- Multiplication and division in polar form:
Let $z_1 = r_1 \text{cis } \theta_1$ and $z_2 = r_2 \text{cis } \theta_2$. Then

$$z_1 z_2 = r_1 r_2 \text{cis}(\theta_1 + \theta_2) \quad \text{and} \quad \frac{z_1}{z_2} = \frac{r_1}{r_2} \text{cis}(\theta_1 - \theta_2)$$

- **De Moivre's theorem** $(r \text{cis } \theta)^n = r^n \text{cis}(n\theta)$, where $n \in \mathbb{Z}$
- **Conjugate root theorem** If a polynomial has real coefficients, then the complex roots occur in conjugate pairs.
- **Fundamental theorem of algebra** Every non-constant polynomial with complex coefficients has at least one linear factor in the complex number system.
- A polynomial of degree n can be factorised over \mathbb{C} into a product of n linear factors.
- If z_1 is a solution of $z^2 = a$, where $a \in \mathbb{C}$, then the other solution is $z_2 = -z_1$.
- The solutions of $z^n = a$, where $a \in \mathbb{C}$, lie on the circle centred at the origin with radius $|a|^{\frac{1}{n}}$. The solutions are equally spaced around the circle at intervals of $\frac{2\pi}{n}$.
- The distance between z_1 and z_2 in the complex plane is $|z_1 - z_2|$.
For example, the set $\{z : |z - (1 + i)| = 2\}$ is a circle with centre $1 + i$ and radius 2.

Short-answer questions

- 1** Express each of the following in the form $a + bi$, where $a, b \in \mathbb{R}$:
- a** $3 + 2i + 5 - 7i$ **b** i^3 **c** $(3 - 2i)(5 + 7i)$
d $(3 - 2i)(3 + 2i)$ **e** $\frac{2}{3 - 2i}$ **f** $\frac{5 - i}{2 + i}$
g $\frac{3i}{2 + i}$ **h** $(1 - 3i)^2$ **i** $\frac{(5 + 2i)^2}{3 - i}$
- 2** Solve each of the following equations for z :
- a** $(z - 2)^2 + 9 = 0$ **b** $\frac{z - 2i}{z + (3 - 2i)} = 2$ **c** $z^2 + 6z + 12 = 0$
d $z^4 + 81 = 0$ **e** $z^3 - 27 = 0$ **f** $8z^3 + 27 = 0$
- 3** **a** Show that $2 - i$ is a solution of the equation $z^3 - 2z^2 - 3z + 10 = 0$. Hence solve the equation for z .
b Show that $3 - 2i$ is a solution of the equation $x^3 - 5x^2 + 7x + 13 = 0$. Hence solve the equation for $x \in \mathbb{C}$.
c Show that $1 + i$ is a solution of the equation $z^3 - 4z^2 + 6z - 4 = 0$. Hence find the other solutions of this equation.
- 4** Express each of the following polynomials as a product of linear factors:
a $2x^2 + 3x + 2$ **b** $x^3 - x^2 + x - 1$ **c** $x^3 + 2x^2 - 4x - 8$
- 5** If $(a + bi)^2 = 3 - 4i$, find the possible values of a and b , where $a, b \in \mathbb{R}$.
- 6** Pair each of the transformations given on the left with the appropriate operation on the complex numbers given on the right:
- a** reflection in the real axis **i** multiply by -1
b rotation anticlockwise by 90° about O **ii** multiply by i
c rotation through 180° about O **iii** multiply by $-i$
d rotation anticlockwise about O through 270° **iv** take the conjugate
- 7** If $(a + bi)^2 = -24 - 10i$, find the possible values of a and b , where $a, b \in \mathbb{R}$.
- 8** Find the values of a and b if $f(z) = z^2 + az + b$ and $f(-1 - 2i) = 0$, where $a, b \in \mathbb{R}$.
- 9** Express $\frac{1}{1 + \sqrt{3}i}$ in the form $r \operatorname{cis} \theta$, where $r > 0$ and $-\pi < \theta \leq \pi$.
- 10** On an Argand diagram with origin O , the point P represents $3 + i$. The point Q represents $a + bi$, where both a and b are positive. If the triangle OPQ is equilateral, find a and b .
- 11** Let $z = 1 - i$. Find:
- a** $2\bar{z}$ **b** $\frac{1}{z}$ **c** $|z^7|$ **d** $\operatorname{Arg}(z^7)$

- 12** Let $w = 1 + i$ and $z = 1 - \sqrt{3}i$.
- a** Write down:
- i** $|w|$ **ii** $|z|$ **iii** $\text{Arg } w$ **iv** $\text{Arg } z$
- b** Hence write down $\left| \frac{w}{z} \right|$ and $\text{Arg}(wz)$.
- 13** Express $\sqrt{3} + i$ in polar form. Hence find $(\sqrt{3} + i)^7$ and express in Cartesian form.
- 14** Consider the equation $z^4 - 2z^3 + 11z^2 - 18z + 18 = 0$. Find all real values of r for which $z = ri$ is a solution of the equation. Hence find all the solutions of the equation.
- 15** Express $(1 - i)^9$ in Cartesian form.
- 16** Consider the polynomial $P(z) = z^3 + (2 + i)z^2 + (2 + 2i)z + 4$. Find the real numbers k such that ki is a zero of $P(z)$. Hence, or otherwise, find the three zeroes of $P(z)$.
- 17** **a** Find the three linear factors of $z^3 - 2z + 4$.
b What is the remainder when $z^3 - 2z + 4$ is divided by $z - 3$?
- 18** If a and b are complex numbers such that $\text{Im}(a) = 2$, $\text{Re}(b) = -1$ and $a + b = -ab$, find a and b .
- 19** **a** Express $S = \{z : |z - (1 + i)| \leq 1\}$ in Cartesian form.
b Sketch S on an Argand diagram.
- 20** Describe $\{z : |z + i| = |z - i|\}$.
- 21** Let $S = \left\{z : z = 2 \text{ cis } \theta, 0 \leq \theta \leq \frac{\pi}{2}\right\}$. Sketch:
- a** S **b** $T = \{w : w = z^2, z \in S\}$ **c** $U = \left\{v : v = \frac{2}{z}, z \in S\right\}$
- 22** Find the centre of the circle which passes through the points $-2i$, 1 and $2 - i$.
- 23** On an Argand diagram, points A and B represent $a = 5 + 2i$ and $b = 8 + 6i$.
- a** Find $i(a - b)$ and show that it can be represented by a vector perpendicular to \overrightarrow{AB} and of the same length as \overrightarrow{AB} .
b Hence find complex numbers c and d , represented by C and D , such that $ABCD$ is a square.
- 24** Solve each of the following for $z \in \mathbb{C}$:
- a** $z^3 = -8$ **b** $z^2 = 2 + 2\sqrt{3}i$
- 25** **a** Factorise $x^6 - 1$ over \mathbb{R} .
b Factorise $x^6 - 1$ over \mathbb{C} .
c Determine all the sixth roots of unity. (That is, solve $x^6 = 1$ for $x \in \mathbb{C}$.)
- 26** Let z be a complex number with a non-zero imaginary part. Simplify:
- a** $\left| \frac{\bar{z}}{z} \right|$ **b** $\frac{i(\text{Re}(z) - z)}{\text{Im}(z)}$ **c** $\text{Arg } z + \text{Arg}\left(\frac{1}{z}\right)$

- 27** If $\text{Arg } z = \frac{\pi}{4}$ and $\text{Arg}(z - 3) = \frac{\pi}{2}$, find $\text{Arg}(z - 6i)$.
- 28 a** If $\text{Arg}(z + 2) = \frac{\pi}{2}$ and $\text{Arg}(z) = \frac{2\pi}{3}$, find z .
- b** If $\text{Arg}(z - 3) = -\frac{3\pi}{4}$ and $\text{Arg}(z + 3) = -\frac{\pi}{2}$, find z .
- 29** A complex number z satisfies the inequality $|z + 2 - 2\sqrt{3}i| \leq 2$.
- a** Sketch the corresponding region representing all possible values of z .
- b i** Find the least possible value of $|z|$.
- ii** Find the greatest possible value of $\text{Arg } z$.



Multiple-choice questions

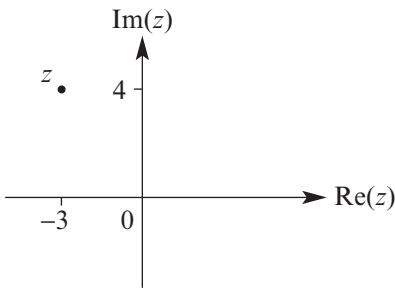

- 1** If $z_1 = 5 \text{cis}\left(\frac{\pi}{3}\right)$ and $z_2 = 2 \text{cis}\left(\frac{3\pi}{4}\right)$, then $z_1 z_2$ is equal to
- A** $7 \text{cis}\left(\frac{\pi^2}{4}\right)$ **B** $7 \text{cis}\left(\frac{13\pi}{12}\right)$ **C** $10 \text{cis}\left(\frac{\pi}{4}\right)$ **D** $10 \text{cis}\left(\frac{\pi^2}{4}\right)$ **E** $10 \text{cis}\left(\frac{-11\pi}{12}\right)$
- 2** The complex number z shown in the diagram is best represented by
- A** $5 \text{cis}(0.93)$
B $5 \text{cis}(126.87)$
C $5 \text{cis}(2.21)$
D $25 \text{cis}(126.87)$
E $25 \text{cis}(2.21)$
- 
- 3** If $(x + yi)^2 = -32i$ for real values of x and y , then
- A** $x = 4, y = 4$ **B** $x = -4, y = 4$
C $x = 4, y = -4$ **D** $x = 4, y = -4$ or $x = -4, y = 4$
E $x = 4, y = 4$ or $x = -4, y = -4$
- 4** If $u = 1 - i$, then $\frac{1}{3 - u}$ is equal to
- A** $\frac{2}{3} + \frac{1}{3}i$ **B** $\frac{2}{5} + \frac{1}{5}i$ **C** $\frac{2}{3} - \frac{1}{3}i$ **D** $-\frac{2}{5} + \frac{1}{5}i$ **E** $\frac{2}{5} - \frac{1}{5}i$
- 5** The linear factors of $z^2 + 6z + 10$ over \mathbb{C} are
- A** $(z + 3 + i)^2$ **B** $(z + 3 - i)^2$ **C** $(z + 3 + i)(z - 3 + i)$
D $(z + 3 - i)(z + 3 + i)$ **E** $(z + 3 + i)(z - 3 - i)$
- 6** The solutions of the equation $z^3 + 8i = 0$ are
- A** $\sqrt{3} - i, -2i, 2i$ **B** $\sqrt{3} - i, -\sqrt{3} - i, 2i$ **C** $-\sqrt{3} - i, -2, -2i$
D $-\sqrt{3} - i, \sqrt{3} - i, -2i$ **E** $\sqrt{3} - i, -8i, 2i$

- 7 $\frac{\sqrt{6}}{2}(1+i)$ is expressed in polar form as
- A** $\sqrt{3} \operatorname{cis}\left(-\frac{\pi}{4}\right)$ **B** $\sqrt{3} \operatorname{cis}\left(-\frac{7\pi}{4}\right)$ **C** $-\sqrt{3} \operatorname{cis}\left(-\frac{\pi}{4}\right)$
D $-\sqrt{3} \operatorname{cis}\left(-\frac{7\pi}{4}\right)$ **E** $\sqrt{3} \operatorname{cis}\left(\frac{7\pi}{4}\right)$
- 8 If $z = 1 + i$ is one solution of an equation of the form $z^4 = a$, where $a \in \mathbb{C}$, then the other solutions are
- A** $-1, 1, 0$ **B** $-1, 1, 1 - i$ **C** $-1 + i, -1 - i, 1 - i$
D $-1 + i, -1 - i, 1$ **E** $-1 + i, -1 - i, -1$
- 9 The square roots of $-2 - 2\sqrt{3}i$ in polar form are
- A** $2 \operatorname{cis}\left(-\frac{2\pi}{3}\right), 2 \operatorname{cis}\left(\frac{\pi}{3}\right)$ **B** $2 \operatorname{cis}\left(-\frac{\pi}{3}\right), 2 \operatorname{cis}\left(\frac{2\pi}{3}\right)$ **C** $4 \operatorname{cis}\left(-\frac{2\pi}{3}\right), 4 \operatorname{cis}\left(\frac{\pi}{3}\right)$
D $4 \operatorname{cis}\left(-\frac{\pi}{3}\right), 4 \operatorname{cis}\left(\frac{2\pi}{3}\right)$ **E** $4 \operatorname{cis}\left(-\frac{\pi}{3}\right), 4 \operatorname{cis}\left(\frac{\pi}{3}\right)$
- 10 The zeroes of the polynomial $2x^2 + 6x + 7$ are α and β . The value of $|\alpha - \beta|$ is
- A** $\sqrt{5}$ **B** $2\sqrt{5}$ **C** $4\sqrt{5}$ **D** $\frac{\sqrt{10}}{2}$ **E** $\frac{\sqrt{5}}{10}$



Extended-response questions

- 1 Let $z = 4 \operatorname{cis}\left(\frac{5\pi}{6}\right)$ and $w = \sqrt{2} \operatorname{cis}\left(\frac{\pi}{4}\right)$.
- Find $|z^7|$ and $\operatorname{Arg}(z^7)$.
 - Show z^7 on an Argand diagram.
 - Express $\frac{z}{w}$ in the form $r \operatorname{cis} \theta$.
 - Express z and w in Cartesian form, and hence express $\frac{z}{w}$ in Cartesian form.
 - Use the results of **d** to find an exact value for $\tan\left(\frac{7\pi}{12}\right)$ in the form $a + \sqrt{b}$, where a and b are rational.
 - Use the result of **e** to find the exact value of $\tan\left(\frac{7\pi}{6}\right)$.
- 2 Let $v = 2 + i$ and $P(z) = z^3 - 7z^2 + 17z - 15$.
- Show by substitution that $P(2 + i) = 0$.
 - Find the other two solutions of the equation $P(z) = 0$.
 - Let \mathbf{i} be the unit vector in the positive $\operatorname{Re}(z)$ -direction and let \mathbf{j} be the unit vector in the positive $\operatorname{Im}(z)$ -direction.
 Let A be the point on the Argand diagram corresponding to $v = 2 + i$.
 Let B be the point on the Argand diagram corresponding to $1 - 2i$.
 Show that \vec{OA} is perpendicular to \vec{OB} .
 - Find a polynomial with real coefficients and with roots $3, 1 - 2i$ and $2 + i$.

- 3 **a** Find the exact solutions in \mathbb{C} for the equation $z^2 - 2\sqrt{3}z + 4 = 0$, writing your solutions in Cartesian form.
- b**
- Plot the two solutions from **a** on an Argand diagram.
 - Find the equation of the circle, with centre the origin, which passes through these two points.
 - Find the value of $a \in \mathbb{Z}$ such that the circle passes through $(0, \pm a)$.
 - Let $Q(z) = (z^2 + 4)(z^2 - 2\sqrt{3}z + 4)$. Find the polynomial $P(z)$ such that $Q(z)P(z) = z^6 + 64$ and explain the significance of the result.
- 4 **a** Express $-4\sqrt{3} - 4i$ in exact polar form.
- b** Find the cube roots of $-4\sqrt{3} - 4i$.
- c** Carefully plot the three cube roots of $-4\sqrt{3} - 4i$ on an Argand diagram.
- d**
- Show that the cubic equation $z^3 - 3\sqrt{3}iz^2 - 9z + 3\sqrt{3}i = -4\sqrt{3} - 4i$ can be written in the form $(z - w)^3 = -4\sqrt{3} - 4i$, where w is a complex number.
 - Hence find the solutions of the equation $z^3 - 3\sqrt{3}iz^2 - 9z + (3\sqrt{3} + 4)i + 4\sqrt{3} = 0$, in exact Cartesian form.
- 5 The points X , Y and Z correspond to the numbers $4\sqrt{3} + 2i$, $5\sqrt{3} + i$ and $6\sqrt{3} + 4i$.
- a** Find the vector \overrightarrow{XY} and the vector \overrightarrow{XZ} .
- b** Let z_1 and z_2 be the complex numbers corresponding to the vectors \overrightarrow{XY} and \overrightarrow{XZ} . Find z_3 such that $z_2 = z_3z_1$.
- c** By writing z_3 in modulus–argument form, show that XYZ is half an equilateral triangle XWZ and give the complex number to which W corresponds.
- d** The triangle XYZ is rotated through an angle of $\frac{\pi}{3}$ anticlockwise about Y . Find the new position of X .
- 6 **a** Sketch the region T in the complex plane which is obtained by reflecting
- $$S = \{z : \operatorname{Re}(z) \leq 2\} \cap \{z : \operatorname{Im}(z) < 2\} \cap \left\{z : \frac{\pi}{6} < \operatorname{Arg}(z) < \frac{\pi}{3}\right\}$$
- in the line defined by $|z + i| = |z - 1|$.
- b** Describe the region T by using set notation in a similar way to that used in **a** to describe S .
- 7 Consider the equation $x^2 + 4x - 1 + k(x^2 + 2x + 1) = 0$. Find the set of real values k , where $k \neq -1$, for which the two solutions of the equation are:
- a** real and distinct **b** real and equal
- c** complex with positive real part and non-zero imaginary part.
- 8 **a** If $z = \cos \theta + i \sin \theta$, prove that $\frac{1+z}{1-z} = i \cot\left(\frac{\theta}{2}\right)$.
- b** On an Argand diagram, the points O , A , Z , P and Q represent the complex numbers 0 , 1 , z , $1 + z$ and $1 - z$ respectively. Show these points on a diagram.
- c** Prove that the magnitude of $\angle POQ$ is $\frac{\pi}{2}$. Find, in terms of θ , the ratio $\frac{|OP|}{|OQ|}$.

- 9** A regular hexagon $LMNPQR$ has its centre at the origin O and its vertex L at the point $z = 4$.
- Indicate in a diagram the region in the hexagon in which the inequalities $|z| \geq 2$ and $-\frac{\pi}{3} \leq \text{Arg } z \leq \frac{\pi}{3}$ are satisfied.
 - Find, in the form $|z - c| = a$, the equation of the circle through O , M and R .
 - Find the complex numbers corresponding to the points N and Q .
 - The hexagon is rotated clockwise about the origin by 45° . Express in the form $r \text{cis } \theta$ the complex numbers corresponding to the new positions of N and Q .
- 10** **a** A complex number $z = a + bi$ is such that $|z| = 1$. Show that $\frac{1}{z} = \bar{z}$.
- Let $z_1 = \frac{1}{2} - \frac{\sqrt{3}}{2}i$ and $z_2 = \frac{\sqrt{3}}{2} + \frac{1}{2}i$. If $z_3 = \frac{1}{z_1} + \frac{1}{z_2}$, find z_3 in polar form.
 - On a diagram, show the points z_1 , z_2 , z_3 and $z_4 = \frac{1}{z_3}$.
- 11** **a** Let $P(z) = z^3 + 3pz + q$. It is known that $P(z) = (z - k)^2(z - a)$.
- Show that $p = -k^2$.
 - Find q in terms of k .
 - Show that $4p^3 + q^2 = 0$.
- b** Let $h(z) = z^3 - 6iz + 4 - 4i$. It is known that $h(z) = (z - b)^2(z - c)$. Find the values of b and c .
- 12** **a** Let z be a complex number with $|z| = 6$. Let A be the point representing z . Let B be the point representing $(1 + i)z$.
- Find $|(1 + i)z|$.
 - Find $|(1 + i)z - z|$.
 - Prove that OAB is an isosceles right-angled triangle.
- b** Let z_1 and z_2 be non-zero complex numbers satisfying $z_1^2 - 2z_1z_2 + 2z_2^2 = 0$. If $z_1 = \alpha z_2$:
- Show that $\alpha = 1 + i$ or $\alpha = 1 - i$.
 - For each of these values of α , describe the geometric nature of the triangle whose vertices are the origin and the points representing z_1 and z_2 .
- 13** **a** Let $z = -12 + 5i$. Find:
- $|z|$
 - $\text{Arg}(z)$ correct to two decimal places in degrees
- b** Let $w^2 = -12 + 5i$ and $\alpha = \text{Arg}(w^2)$.
- Write $\cos \alpha$ and $\sin \alpha$ in exact form.
 - Using the result $r^2(\cos(2\theta) + i \sin(2\theta)) = |w^2|(\cos \alpha + i \sin \alpha)$, write r , $\cos(2\theta)$ and $\sin(2\theta)$ in exact form.
 - Use the result of **ii** to find $\sin \theta$ and $\cos \theta$.
 - Find the two values of w .
- c** Use a Cartesian method to find w .
- d** Find the square roots of $12 + 5i$ and comment on their relationship with the square roots of $-12 + 5i$.

- 14 a** Find the locus defined by $2z\bar{z} + 3z + 3\bar{z} - 10 = 0$.
- b** Find the locus defined by $2z\bar{z} + (3 + i)z + (3 - i)\bar{z} - 10 = 0$.
- c** Find the locus defined by $\alpha z\bar{z} + \beta z + \bar{\beta}\bar{z} + \gamma = 0$, where α, β and γ are real.
- d** Find the locus defined by $\alpha z\bar{z} + \beta z + \bar{\beta}\bar{z} + \gamma = 0$, where $\alpha, \gamma \in \mathbb{R}$ and $\beta \in \mathbb{C}$.
- 15 a** Expand $(\cos \theta + i \sin \theta)^5$.
- b** By De Moivre's theorem, we know that $(\text{cis } \theta)^5 = \text{cis}(5\theta)$. Use this result and the result of **a** to show that:
- i** $\cos(5\theta) = 16 \cos^5 \theta - 20 \cos^3 \theta + 5 \cos \theta$
- ii** $\frac{\sin(5\theta)}{\sin \theta} = 16 \cos^4 \theta - 12 \cos^2 \theta + 1$ if $\sin \theta \neq 0$
- 16 a** If \bar{z} denotes the complex conjugate of the number $z = x + yi$, find the Cartesian equation of the line given by $(1 + i)z + (1 - i)\bar{z} = -2$.
Sketch on an Argand diagram the set $\left\{ z : (1 + i)z + (1 - i)\bar{z} = -2, \text{Arg } z \leq \frac{\pi}{2} \right\}$.
- b** Let $S = \left\{ z : |z - (2\sqrt{2} + 2\sqrt{2}i)| \leq 2 \right\}$.
- i** Sketch S on an Argand diagram.
- ii** If z belongs to S , find the maximum and minimum values of $|z|$.
- iii** If z belongs to S , find the maximum and minimum values of $\text{Arg}(z)$.
- 17** The roots of the polynomial $z^2 + 2z + 4$ are denoted by α and β .
- a** Find α and β in polar form.
- b** Show that $\alpha^3 = \beta^3$.
- c** Find a quadratic polynomial for which the roots are $\alpha + \beta$ and $\alpha - \beta$.
- d** Find the exact value of $\alpha\bar{\beta} + \beta\bar{\alpha}$.
- 18 a** Let $w = 2 \text{cis } \theta$ and $z = w + \frac{1}{w}$.
- i** Find z in terms of θ .
- ii** Show that z lies on the ellipse with equation $\frac{x^2}{25} + \frac{y^2}{9} = \frac{1}{4}$.
- iii** Show that $|z - 2|^2 = \left(\frac{5}{2} - 2 \cos \theta\right)^2$.
- iv** Show that $|z - 2| + |z + 2| = 5$.
- b** Let $w = 2i \text{cis } \theta$ and $z = w - \frac{1}{w}$.
- i** Find z in terms of θ .
- ii** Show that z lies on the ellipse with equation $\frac{y^2}{25} + \frac{x^2}{9} = \frac{1}{4}$.
- iii** Show that $|z - 2i| + |z + 2i| = 5$.



9

Revision of Chapters 5–8

9A Short-answer questions

- Consider the vectors $\mathbf{a} = -2\mathbf{i} + 3\mathbf{j} - \mathbf{k}$, $\mathbf{b} = \mathbf{i} - 3\mathbf{j} + 2\mathbf{k}$ and $\mathbf{c} = m\mathbf{i} + n\mathbf{j}$. Find $\frac{m}{n}$ such that \mathbf{a} , \mathbf{b} and \mathbf{c} form a linearly independent set of vectors.
- The coordinates of three points are $A(2, 1, 2)$, $B(-3, 2, 5)$ and $C(4, 5, -2)$. The point D is such that $ABCD$ is a parallelogram.
 - Find the position vector of D .
 - Find the coordinates of the point at which the diagonals of the parallelogram $ABCD$ intersect.
 - Find $\cos(\angle BAC)$.
- Solve the following system of linear equations:

$$\begin{aligned} 2x - y + z &= 0 \\ y + 2z &= 1 \\ 2x + 5z &= 2 \end{aligned}$$
- Find all solutions of $z^4 - z^2 - 12 = 0$ for $z \in \mathbb{C}$.
- Resolve the vector $3\mathbf{i} + 2\mathbf{j} - \mathbf{k}$ into two vector components, one of which is parallel to the vector $2\mathbf{i} + \mathbf{j} + 2\mathbf{k}$ and one of which is perpendicular to it.
- Consider $z = \frac{\sqrt{3} - i}{1 - i}$. Find $\text{Arg } z$.
- Let $P(z) = z^5 - 6z^3 - 2z^2 + 17z - 10$. Given that $P(1) = P(2) = 0$, solve the equation $P(z) = 0$ for $z \in \mathbb{C}$.

- 8** Point A has coordinates $(2, 2, 1)$ and point B has coordinates $(1, 2, 1)$, relative to an origin O .
- a** Find \overrightarrow{AB} . **b** Find $\cos(\angle AOB)$. **c** Find the area of triangle AOB .
- 9** Consider the vectors $\mathbf{a} = -2\mathbf{i} - 3\mathbf{j} + m\mathbf{k}$, $\mathbf{b} = \mathbf{i} - \frac{3}{2}\mathbf{j} + 2\mathbf{k}$ and $\mathbf{c} = 2\mathbf{i} + \mathbf{j} - \mathbf{k}$.
- a** Find the values of m for which $|\mathbf{a}| = \sqrt{38}$.
b Find the value of m such that \mathbf{a} is perpendicular to \mathbf{b} .
c Find $-2\mathbf{b} + 3\mathbf{c}$.
d Hence find m such that \mathbf{a} , \mathbf{b} and \mathbf{c} are linearly dependent.
- 10** **a** Solve the equation $z^3 - 2z^2 + 2z - 1 = 0$ for $z \in \mathbb{C}$.
b Write the solutions in polar form.
c Show the solutions on an Argand diagram.
- 11** Let $z = \sqrt{3} + i$. Plot z , z^2 and z^3 on an Argand diagram.
- 12** **a** Show that $z - 1 - i$ is a factor of $f(z) = z^3 - (5 + i)z^2 + (17 + 4i)z - 13 - 13i$.
b Hence factorise $f(z)$.
- 13** Points A and B have position vectors $\overrightarrow{OA} = \mathbf{i} + \sqrt{3}\mathbf{j}$ and $\overrightarrow{OB} = 3\mathbf{i} - 4\mathbf{k}$. Point P lies on AB with $\overrightarrow{AP} = \lambda\overrightarrow{AB}$.
- a** Show that $\overrightarrow{OP} = (1 + 2\lambda)\mathbf{i} + \sqrt{3}(1 - \lambda)\mathbf{j} - 4\lambda\mathbf{k}$.
b Hence find λ , if OP is the bisector of $\angle AOB$.
- 14** Let $f(z) = z^2 + aiz + b$, where a and b are real numbers.
- a** Use the quadratic formula to show that the equation $f(z) = 0$ has imaginary solutions only when $b \geq -\frac{a^2}{4}$.
b Hence solve each of the following:
i $z^2 + 2iz + 1 = 0$ **ii** $z^2 - 2iz - 1 = 0$ **iii** $z^2 + 2iz - 2 = 0$
- 15** **a** If the equation $z^3 + az^2 + bz + c = 0$ has solutions $-1 + i$, -1 and $-1 - i$, find the values of a , b and c .
b If $\sqrt{3} + i$ and $-2i$ are two of the solutions to the equation $z^3 = w$, where w is a complex number, find the third solution.
- 16** **a** Find a unit vector perpendicular to the line $2y + 3x = 6$.
b Let A be the point $(2, -5)$ and let P be the point on the line $2y + 3x = 6$ such that AP is perpendicular to the line. Find:
i \overrightarrow{AP} **ii** $|\overrightarrow{AP}|$
- 17** For each of the following, find a vector equation of the line through the two points:
a $(0, 0, 0)$, $(3, 0, 4)$ **b** $(0, 2, 1)$, $(-1, 3, 4)$ **c** $(3, 2, 4)$, $(0, 4, -2)$

- 18** For each of the following, find a vector equation of the plane that contains the three points:

a $(0, 0, 0)$, $(1, 2, 3)$, $(1, 3, 5)$ **b** $(2, -3, 5)$, $(3, -2, 6)$, $(1, -2, 4)$
c $(3, 2, 4)$, $(0, 4, -2)$, $(3, 6, 0)$

- 19 a** Find the perpendicular distance between the parallel planes with equations $2x + 2y + z = 6$ and $2x + 2y + z = 10$.

- b** Find the area of the triangle with vertices $(2, 2, 2)$, $(1, 1, 2)$ and $(1, -1, 6)$.

- 20** Find the point of intersection of the lines ℓ_1 and ℓ_2 given by

$$\ell_1: \mathbf{r} = 2t\mathbf{i} + (2 - 2t)\mathbf{j} + (3 - 4t)\mathbf{k}, \quad t \in \mathbb{R}$$

$$\ell_2: \mathbf{r} = (3 + s)\mathbf{i} + (s - 1)\mathbf{j} + (4s - 3)\mathbf{k}, \quad s \in \mathbb{R}$$

- 21** Consider the following system of linear equations:

$$x + ay - z = 0$$

$$2x + y + z = k$$

$$x - y + z = 2$$

- a** Show that, if $a \neq 5$, then there is a unique solution. Find this solution in terms of k .

- b** Given that $a = 5$, find the values of k for which there are no solutions.

- c** Given that $a = 5$, find the values of k for which there are infinitely many solutions.

- 22** Find the coordinates of the point where the line through $(0, 1, 0)$ and $(1, 0, 1)$ meets the plane with equation $x + y + z = 1$.

- 23** Find the angle between each pair of planes:

a $2x + 3y - z = 0$, $x - y - z = 4$ **b** $4x + 3y + 2z = 5$, $2x - 4y + 3z = 6$

- 24** Find the length of the perpendicular from the point with coordinates $(4, 0, 1)$ to the plane with equation $3x + 6y + 2z = -7$.

- 25 a** Find the value of a for which the three planes $2x - y + 5z = 7$, $5x + 3y - z = 4$ and $3x + 4y - 6z = a$ intersect in a line.

- b** Find a vector equation of this line.

- 26** Points A , B and C are defined by position vectors \mathbf{a} , \mathbf{b} and \mathbf{c} respectively.

- a** Let $\mathbf{a} = 2\mathbf{i} - 2\mathbf{j} + 5\mathbf{k}$, $\mathbf{b} = -\mathbf{i} + 2\mathbf{j} - 6\mathbf{k}$ and $\mathbf{c} = -4\mathbf{i} + 2\mathbf{j} - 3\mathbf{k}$. Show that the vectors \mathbf{a} , \mathbf{b} and \mathbf{c} are linearly dependent by finding values of m and n such that $\mathbf{c} = m\mathbf{a} + n\mathbf{b}$.

- b** If P is a point on AB such that $\overrightarrow{OP} = \lambda\mathbf{c}$, find the value of λ .

- 27** For which value(s) of a will the following system of equations have no solutions?

$$ax + y + 2z = 4$$

$$x + 2y + z = -3$$

$$2x - y - 2z = 1$$

- 28 Consider the following system of equations:

$$ax + y + 2z = 4$$

$$2x + 2y + 3z = 1$$

$$2x - y - 4z = b$$

Find the values of a and b such that this system has infinitely many solutions. Give the solutions in this case.

- 29 Consider the simultaneous equations $ax + by = 3$ and $bx + ay = 4$, where a and b are constants. If this pair of equations has no solutions, then how must a and b be related?

9B Multiple-choice questions

- 1 If $\mathbf{a} = 2\mathbf{i} + 3\mathbf{j} - 4\mathbf{k}$, $\mathbf{b} = -\mathbf{i} + 2\mathbf{j} - 2\mathbf{k}$ and $\mathbf{c} = -3\mathbf{j} + 4\mathbf{k}$, then $\mathbf{a} - 2\mathbf{b} - \mathbf{c}$ equals
A $3\mathbf{i} + 10\mathbf{j} - 12\mathbf{k}$ **B** $-3\mathbf{i} + 7\mathbf{j} - 12\mathbf{k}$ **C** $4\mathbf{i} + 2\mathbf{j} - 4\mathbf{k}$
D $-4\mathbf{j} + 4\mathbf{k}$ **E** $2\mathbf{j} - 4\mathbf{k}$
- 2 A vector of magnitude 6 and with direction opposite to $\mathbf{i} - 2\mathbf{j} + 2\mathbf{k}$ is
A $6\mathbf{i} - 12\mathbf{j} + 12\mathbf{k}$ **B** $-6\mathbf{i} + 12\mathbf{j} - 2\mathbf{k}$ **C** $-3\mathbf{i} + 6\mathbf{j} - 6\mathbf{k}$
D $-2\mathbf{i} + 4\mathbf{j} - 4\mathbf{k}$ **E** $\frac{2}{3}\mathbf{i} - \frac{4}{3}\mathbf{j} + \frac{4}{3}\mathbf{k}$
- 3 If $\mathbf{a} = 2\mathbf{i} - 3\mathbf{j} - \mathbf{k}$ and $\mathbf{b} = -2\mathbf{i} + 3\mathbf{j} - 6\mathbf{k}$, then the vector resolute of \mathbf{a} in the direction of \mathbf{b} is
A $7(-2\mathbf{i} + 3\mathbf{j} - 6\mathbf{k})$ **B** $\frac{1}{7}(2\mathbf{i} - 3\mathbf{j} + 6\mathbf{k})$ **C** $-\frac{1}{7}(2\mathbf{i} - 3\mathbf{j} - \mathbf{k})$
D $-\frac{7}{11}(2\mathbf{i} - 3\mathbf{j} - \mathbf{k})$ **E** $-\frac{19}{49}(-2\mathbf{i} + 3\mathbf{j} - 6\mathbf{k})$
- 4 If $\mathbf{a} = 3\mathbf{i} - 5\mathbf{j} + \mathbf{k}$, then a vector which is not perpendicular to \mathbf{a} is
A $\frac{1}{35}(3\mathbf{i} - 5\mathbf{j} + \mathbf{k})$ **B** $2\mathbf{i} + \mathbf{j} - \mathbf{k}$ **C** $\mathbf{i} - \mathbf{j} - 8\mathbf{k}$
D $-3\mathbf{i} + 5\mathbf{j} + 34\mathbf{k}$ **E** $\frac{1}{9}(-3\mathbf{i} - 2\mathbf{j} - \mathbf{k})$
- 5 The magnitude of vector $\mathbf{a} = \mathbf{i} - 3\mathbf{j} + 5\mathbf{k}$ is
A 3 **B** $\sqrt{17}$ **C** 35 **D** 17 **E** $\sqrt{35}$
- 6 If $\mathbf{u} = 2\mathbf{i} - \sqrt{2}\mathbf{j} + \mathbf{k}$ and $\mathbf{v} = \mathbf{i} + \sqrt{2}\mathbf{j} - \mathbf{k}$, then the angle between the direction of \mathbf{u} and \mathbf{v} , correct to two decimal places, is
A 92.05° **B** 87.95° **C** 79.11° **D** 100.89° **E** 180°
- 7 Let $\mathbf{u} = 2\mathbf{i} - a\mathbf{j} - \mathbf{k}$ and $\mathbf{v} = 3\mathbf{i} + 2\mathbf{j} - b\mathbf{k}$. Then \mathbf{u} and \mathbf{v} are perpendicular to each other when
A $a = 2$ and $b = -1$ **B** $a = -2$ and $b = 10$ **C** $a = \frac{1}{2}$ and $b = -5$
D $a = 0$ and $b = 0$ **E** $a = -1$ and $b = 5$

- 8** Let $\mathbf{u} = i + aj - 4k$ and $\mathbf{v} = bi - 2j + 3k$. Then \mathbf{u} and \mathbf{v} are parallel to each other when
- A** $a = -2$ and $b = 1$ **B** $a = -\frac{8}{3}$ and $b = -\frac{3}{4}$ **C** $a = -\frac{3}{2}$ and $b = -\frac{3}{4}$
D $a = -\frac{8}{3}$ and $b = -\frac{4}{3}$ **E** none of these
- 9** Let $\mathbf{a} = i - 5j + k$ and $\mathbf{b} = 2i - j + 2k$. Then the vector component of \mathbf{a} perpendicular to \mathbf{b} is
- A** $-i - 4j - k$ **B** $i + 4j + k$ **C** $-5i + j - 5k$
D $5i - j + 5k$ **E** $\frac{5}{3}i + \frac{2}{3}j + \frac{5}{3}k$
- 10** If points A , B and C are such that $\overrightarrow{AB} \cdot \overrightarrow{BC} = 0$, which of the following statements must be true?
- A** Either \overrightarrow{AB} or \overrightarrow{BC} is a zero vector. **B** $|\overrightarrow{AB}| = |\overrightarrow{BC}|$
C The vector resolute of \overrightarrow{AC} in the direction of \overrightarrow{AB} is \overrightarrow{AB} .
D The vector resolute of \overrightarrow{AB} in the direction of \overrightarrow{AC} is \overrightarrow{AC} .
E Points A , B and C are collinear.
- 11** If $\mathbf{u} = i - j - k$ and $\mathbf{v} = 4i + 12j - 3k$, then $\mathbf{u} \cdot \mathbf{v}$ equals
- A** $4i - 12j + 3k$ **B** $5i + 11j - 4k$ **C** -5
D 19 **E** $\frac{5}{13}$
- 12** If $\mathbf{a} = 3i + 2j - k$ and $\mathbf{b} = 6i - 3j + 2k$, then the scalar resolute of \mathbf{a} in the direction of \mathbf{b} is
- A** $\frac{10}{49}(6i - 3j - 2k)$ **B** $\frac{10}{7}$ **C** $2i - \frac{3}{2}j - 2k$
D $\frac{10}{49}$ **E** $\frac{\sqrt{10}}{7}$
- 13** Let $\mathbf{a} = 3i - 5j - 2k$ and $\mathbf{b} = 2i - 3j - 4k$. The unit vector in the direction of $\mathbf{a} - \mathbf{b}$ is
- A** $i - 2j + 2k$ **B** $\frac{1}{\sqrt{65}}(5i - 2j - 6k)$ **C** $\frac{1}{3}(i - 2j + 2k)$
D $\frac{1}{9}(i - 2j + 2k)$ **E** $\frac{1}{3}(-i + 2j - 2k)$
- 14** $(2i + 3j + k) \cdot (i - 4j + k)$ equals
- A** $2i - 12j + k$ **B** 9 **C** -9
D $9i$ **E** $-9i$
- 15** If the points P , Q and R are collinear with $\overrightarrow{OP} = 3i + j - k$, $\overrightarrow{OQ} = i - 2j + k$ and $\overrightarrow{OR} = 2i + pj + qk$, then
- A** $p = -3$ and $q = 2$ **B** $p = -\frac{7}{2}$ and $q = 2$ **C** $p = -\frac{1}{2}$ and $q = 0$
D $p = 3$ and $q = -2$ **E** $p = -\frac{1}{2}$ and $q = 2$

- 16 If $\mathbf{a} = 3\mathbf{i} + 4\mathbf{j}$, $\mathbf{b} = 2\mathbf{i} - \mathbf{j}$, $\mathbf{x} = \mathbf{i} + 5\mathbf{j}$ and $\mathbf{x} = s\mathbf{a} + t\mathbf{b}$, then the scalars s and t are given by

A $s = -1$ and $t = -1$ B $s = -1$ and $t = 1$ C $s = 1$ and $t = -1$
 D $s = 1$ and $t = 1$ E $s = \sqrt{5}$ and $t = 5$

- 17 Given that $\mathbf{p} = \overrightarrow{OP}$, $\mathbf{q} = \overrightarrow{OQ}$ and the points O , P and Q are not collinear, which one of the following points, whose position vectors are given, is not collinear with P and Q ?

A $\frac{1}{2}\mathbf{p} + \frac{1}{2}\mathbf{q}$ B $3\mathbf{p} - 2\mathbf{q}$ C $\mathbf{p} - \mathbf{q}$ D $\frac{1}{3}\mathbf{p} + \frac{2}{3}\mathbf{q}$ E $2\mathbf{p} - \mathbf{q}$

- 18 PQR is a straight line and $PQ = 2QR$.

If $\overrightarrow{OQ} = 3\mathbf{i} - 2\mathbf{j}$ and $\overrightarrow{OR} = \mathbf{i} + 3\mathbf{j}$, then \overrightarrow{OP} is equal to

A $-\mathbf{i} + 8\mathbf{j}$ B $7\mathbf{i} - 12\mathbf{j}$ C $4\mathbf{i} - 10\mathbf{j}$
 D $-4\mathbf{i} + 10\mathbf{j}$ E $-7\mathbf{i} + 12\mathbf{j}$

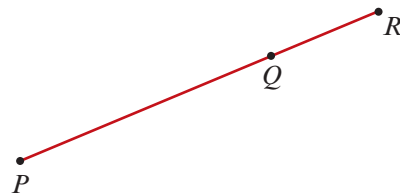

- 19 If $\overrightarrow{OP} = 2\mathbf{i} - 2\mathbf{j} + \mathbf{k}$ and $\overrightarrow{PQ} = 2\mathbf{i} + 2\mathbf{j} - \mathbf{k}$, then $|\overrightarrow{OQ}|$ equals

A $2\sqrt{5}$ B $3\sqrt{2}$ C 6 D 9 E 4

- 20 Consider the simultaneous linear equations

$$\begin{aligned} mx - 2y &= 0 \\ 6x - (m + 4)y &= 0 \end{aligned}$$

where m is a real constant. These equations have a unique solution provided

A $m \in \{-6, 2\}$ B $m \in \mathbb{R} \setminus \{-6, 2\}$ C $m \in \mathbb{R} \setminus \{2\}$
 D $m \in \mathbb{R} \setminus \{-2, 6\}$ E $m \in \mathbb{R} \setminus \{0\}$

- 21 The position vectors of points P and Q relative to an origin O are $\overrightarrow{OP} = -\mathbf{i} + \mathbf{j} - \mathbf{k}$ and $\overrightarrow{OQ} = \mathbf{i} - 2\mathbf{j} + \mathbf{k}$. A unit vector perpendicular to the plane OPQ is

A $\frac{1}{\sqrt{17}}(2\mathbf{i} - 3\mathbf{j} + 2\mathbf{k})$ B $\frac{1}{\sqrt{10}}(3\mathbf{i} + \mathbf{k})$ C $\frac{1}{\sqrt{6}}(-\mathbf{i} - 2\mathbf{j} + \mathbf{k})$
 D $\frac{1}{\sqrt{2}}(\mathbf{i} - \mathbf{k})$ E $\frac{1}{\sqrt{2}}(\mathbf{i} + \mathbf{j})$

- 22 Assume that $\mathbf{r} = \mathbf{a} + t\mathbf{b}$, $t \in \mathbb{R}$, is a vector equation of a line that does not pass through the origin. Which one of the following is *not* the position vector of a point on the line?

A \mathbf{a} B \mathbf{b} C $\mathbf{a} + \mathbf{b}$ D $\mathbf{a} - \mathbf{b}$ E $\mathbf{a} - 7\mathbf{b}$

- 23 The two lines given by the vector equations $\mathbf{r} = 9\mathbf{i} - 2\mathbf{j} + \lambda(3\mathbf{i} - \mathbf{j})$, for $\lambda \in \mathbb{R}$, and $\mathbf{s} = 3\mathbf{i} - 2\mathbf{j} + \mu(3\mathbf{i} + \mathbf{j})$, for $\mu \in \mathbb{R}$, intersect at the point with coordinates

A (12, -3) B (6, -1) C (0, -3) D (3, 0) E (0, 1)

- 24 The plane with vector equation $\mathbf{r} \cdot (\mathbf{i} - \mathbf{j} + \mathbf{k}) = 2$ contains the point

A (1, -1, 1) B (-1, 1, 0) C (0, 1, 1) D (2, 0, 0) E (0, 0, 0)

- 25 For the straight line ℓ given by the vector equation

$$\mathbf{r} = -\mathbf{i} - 3\mathbf{j} - 3\mathbf{k} + t(2\mathbf{i} + \mathbf{j} + 3\mathbf{k}), \quad t \in \mathbb{R}$$

which one of the following is true?

- A** The line ℓ is parallel to the vector $-2\mathbf{i} + 3\mathbf{j} + 6\mathbf{k}$.
B The line ℓ is perpendicular to the vector $\mathbf{i} - \mathbf{j} - 2\mathbf{k}$.
C The line ℓ passes through the point $(-2, -3, 6)$.
D The line ℓ passes through the origin.
E The line ℓ lies in the plane with equation $x + y - z = -1$.
- 26 A system of linear equations has an augmented matrix in row-echelon form as shown.

$$\begin{array}{l} 2x + y + z = 3 \\ x + 2y - 2z = 4 \\ x - 4y + 8z = -6 \end{array} \quad \left[\begin{array}{ccc|c} 1 & 0 & \frac{4}{3} & \frac{2}{3} \\ 0 & 1 & -\frac{5}{3} & \frac{5}{3} \\ 0 & 0 & 0 & 0 \end{array} \right]$$

The set of all solutions of this system of equations can be described as

- A** $x = 0, y = 0, z = 0$ **B** $x = \frac{2}{3}, y = \frac{5}{3}, z = 0$
C $x = \frac{4}{3}, y = -\frac{5}{3}, z = 0$ **D** $x = \frac{2 - 4\lambda}{3}, y = \frac{5 + 5\lambda}{3}, z = \lambda, \lambda \in \mathbb{R}$
E $x = \frac{2\lambda - 4}{3}, y = \frac{5\lambda + 5}{3}, z = \lambda, \lambda \in \mathbb{R}$

- 27 Let \mathbf{u} and \mathbf{v} be non-zero vectors in three dimensions. If $\mathbf{u} \cdot \mathbf{v} = |\mathbf{u} \times \mathbf{v}|$, then the angle between \mathbf{u} and \mathbf{v} is

- A** 0 **B** $\frac{\pi}{6}$ **C** $\frac{\pi}{4}$ **D** $\frac{\pi}{3}$ **E** $\frac{\pi}{2}$

- 28 If $z_1 = 2 - i$ and $z_2 = 3 + 4i$, then $\left| \frac{z_2}{z_1} \right|^2$ equals

- A** $\sqrt{5}$ **B** 5 **C** $\frac{125}{9}$ **D** $\left(\frac{2 + 11i}{5} \right)^2$ **E** $\left(\frac{10 + 5i}{5} \right)^2$

- 29 If $z = -1 - \sqrt{3}i$, then $\text{Arg } z$ equals

- A** $-\frac{2\pi}{3}$ **B** $-\frac{5\pi}{6}$ **C** $\frac{2\pi}{3}$ **D** $\frac{5\pi}{6}$ **E** $-\frac{\pi}{3}$

- 30 The vectors $p\mathbf{i} + 2\mathbf{j} - 3p\mathbf{k}$ and $p\mathbf{i} + \mathbf{k}$ are perpendicular when $p =$

- A** 0 only **B** 3 only **C** 0 or 3 **D** 1 or 2 **E** 1 only

- 31 One solution of the equation $z^3 - 5z^2 + 17z - 13 = 0$ is $2 + 3i$. The other solutions are

- A** $-2 - 3i$ and 1 **B** $2 - 3i$ and 1 **C** $-2 + 3i$ and -1
D $2 - 3i$ and -1 **E** $-2 + 3i$ and 1

- 32 The value of $\frac{(\cos 60^\circ + i \sin 60^\circ)^4}{(\cos 30^\circ + i \sin 30^\circ)^2}$ is

- A** -1 **B** i **C** $-i$ **D** $\frac{1}{2} - \frac{\sqrt{3}}{2}i$ **E** $\frac{\sqrt{3}}{2} - \frac{1}{2}i$

33 If $3\vec{OX} + 4\vec{OY} = 7\vec{OZ}$, then $\frac{XZ}{ZY}$ equals

- A $\frac{3}{5}$ B $\frac{3}{4}$ C 1
 D $\frac{4}{3}$ E $\frac{5}{3}$

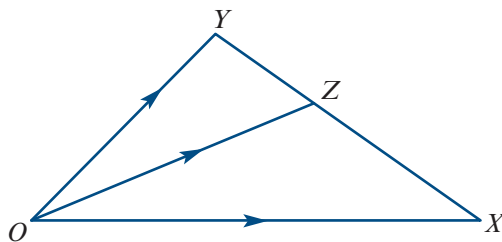

34 If $x + yi = \frac{1}{3 + 4i}$, where x and y are real, then

- A $x = \frac{3}{25}$ and $y = -\frac{4}{25}$ B $x = \frac{3}{25}$ and $y = \frac{4}{25}$ C $x = -\frac{3}{7}$ and $y = \frac{4}{7}$
 D $x = \frac{1}{3}$ and $y = \frac{1}{4}$ E $x = 3$ and $y = -4$

35 Let $\mathbf{a} = 2\mathbf{i} + 3\mathbf{j} + 4\mathbf{k}$ and $\mathbf{b} = \mathbf{i} + p\mathbf{j} + \mathbf{k}$. If \mathbf{a} and \mathbf{b} are perpendicular, then p equals

- A $-\frac{7}{3}$ B -2 C $-\frac{5}{3}$ D 2 E $\frac{7}{3}$

36 Let $z = \frac{1}{1-i}$. If $r = |z|$ and $\theta = \text{Arg } z$, then

- A $r = 2$ and $\theta = \frac{\pi}{4}$ B $r = \frac{1}{2}$ and $\theta = \frac{\pi}{4}$ C $r = \sqrt{2}$ and $\theta = -\frac{\pi}{4}$
 D $r = \frac{1}{\sqrt{2}}$ and $\theta = -\frac{\pi}{4}$ E $r = \frac{1}{\sqrt{2}}$ and $\theta = \frac{\pi}{4}$

37 If $u = 3 \text{cis}\left(\frac{\pi}{4}\right)$ and $v = 2 \text{cis}\left(\frac{\pi}{2}\right)$, then uv is equal to

- A $\text{cis}\left(\frac{7\pi}{4}\right)$ B $6 \text{cis}\left(\frac{\pi^2}{8}\right)$ C $6 \text{cis}^2\left(\frac{\pi^2}{8}\right)$ D $5 \text{cis}\left(\frac{3\pi}{4}\right)$ E $6 \text{cis}\left(\frac{3\pi}{4}\right)$

38 The modulus of $12 - 5i$ is

- A 119 B 7 C 13 D $\sqrt{119}$ E $\sqrt{7}$

39 When $\sqrt{3} - i$ is divided by $-1 - i$, the modulus and the principal argument of the quotient are

- A $2\sqrt{2}$ and $\frac{7\pi}{12}$ B $\sqrt{2}$ and $\frac{-11\pi}{12}$ C $\sqrt{2}$ and $\frac{7\pi}{12}$
 D $2\sqrt{2}$ and $\frac{-11\pi}{12}$ E $\sqrt{2}$ and $\frac{11\pi}{12}$

40 The equation $x^2 + 3x + 1 = 0$ has

- A no solutions B two imaginary solutions C two complex solutions
 D two real solutions E one real and one complex solution

41 The product of the complex numbers $\frac{1-i}{\sqrt{2}}$ and $\frac{\sqrt{3}+i}{2}$ has argument

- A $-\frac{5\pi}{12}$ B $-\frac{\pi}{12}$ C $\frac{\pi}{12}$ D $\frac{5\pi}{12}$ E none of these

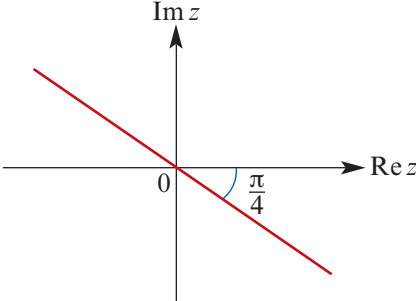
- 42** The modulus of $1 + \cos(2\theta) + i \sin(2\theta)$, where $0 < \theta < \frac{\pi}{2}$, is
A $4 \cos^2 \theta$ **B** $4 \sin^2 \theta$ **C** $2 \cos \theta$ **D** $2 \sin \theta$ **E** none of these
- 43** An expression for the argument of $1 + \cos \theta + i \sin \theta$ is
A $2 \cos\left(\frac{\theta}{2}\right)$ **B** $2 \sin\left(\frac{\theta}{2}\right)$ **C** θ **D** $\frac{\theta}{2}$ **E** $\frac{\pi}{2} - \frac{\theta}{2}$
- 44** A quadratic equation with solutions $2 + 3i$ and $2 - 3i$ is
A $x^2 + 4x + 13 = 0$ **B** $x^2 - 4x + 13 = 0$ **C** $x^2 + 4x - 13 = 0$
D $x^2 + 4x - 5 = 0$ **E** $x^2 - 4x - 5 = 0$
- 45** The subset of the complex plane defined by the equation $|z - 2| - |z + 2| = 0$ is
A a circle **B** an ellipse **C** a straight line
D the empty set **E** a hyperbola
- 46** The subset of the complex plane defined by the equation $|z - (2 - i)| = 6$ is
A a circle with centre at $-2 + i$ and radius 6
B a circle with centre at $2 - i$ and radius 6
C a circle with centre at $2 - i$ and radius 36
D a circle with centre at $-2 + i$ and radius 36
E a circle with centre at $-2 - i$ and radius 36
- 47** The graph shown can be represented by the set
A $\left\{ z : \text{Arg } z = \frac{\pi}{4} \right\}$
B $\left\{ z : \text{Arg } z = -\frac{\pi}{4} \right\}$
C $\left\{ z : \text{Arg } z = \frac{7\pi}{4} \right\}$
D $\{ z : \text{Im } z + \text{Re } z = 0 \}$
E $\{ z : \text{Im } z - \text{Re } z = 0 \}$
- 
- 48** The subset of the complex plane defined by the equation $|z - 2| - |z - 2i| = 0$ is
A a circle **B** an ellipse **C** a straight line
D the empty set **E** a hyperbola
- 49** Which one of the following subsets of the complex plane is **not** a circle?
A $\{ z : |z| = 2 \}$ **B** $\{ z : |z - i| = 2 \}$ **C** $\{ z : z\bar{z} + 2 \text{Re}(iz) = 0 \}$
D $\{ z : |z - 1| = 2 \}$ **E** $\{ z : |z| = 2i \}$
- 50** Which one of the following subsets of the complex plane is **not** a line?
A $\{ z : \text{Im}(z) = 0 \}$ **B** $\{ z : \text{Im}(z) + \text{Re}(z) = 1 \}$ **C** $\{ z : z + \bar{z} = 4 \}$
D $\left\{ z : \text{Arg}(z) = \frac{\pi}{4} \right\}$ **E** $\{ z : \text{Re}(z) = \text{Im}(z) \}$

- 51 Points P , Q , R and M are such that $\overrightarrow{PQ} = 5\mathbf{i}$, $\overrightarrow{PR} = \mathbf{i} + \mathbf{j} + 2\mathbf{k}$ and \overrightarrow{RM} is parallel to \overrightarrow{PQ} so that $\overrightarrow{RM} = \lambda\mathbf{i}$, where λ is a constant. The value of λ for which angle RQM is a right angle is

A 0 B $\frac{19}{4}$ C $\frac{21}{4}$ D 10 E 6

- 52 In this diagram, $\overrightarrow{OA} = 6\mathbf{i} - \mathbf{j} + 8\mathbf{k}$,
 $\overrightarrow{OB} = -3\mathbf{i} + 4\mathbf{j} - 2\mathbf{k}$ and $AP : PB = 1 : 2$.

The vector \overrightarrow{OP} is equal to

A $\frac{7}{3}\mathbf{j} + \frac{4}{3}\mathbf{k}$ B $3\mathbf{i} + \frac{7}{3}\mathbf{j} + \frac{4}{3}\mathbf{k}$
 C $3\mathbf{j} + 4\mathbf{k}$ D $3\mathbf{i} + \frac{2}{3}\mathbf{j} + \frac{14}{3}\mathbf{k}$

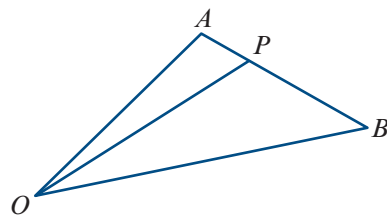

E none of these

- 53 In an Argand diagram, O is the origin, P is the point $(2, 1)$ and Q is the point $(1, 2)$. If P represents the complex number z and Q the complex number α , then α equals

A \bar{z} B $i\bar{z}$ C $-\bar{z}$ D $-i\bar{z}$ E $z\bar{z}$

- 54 In an Argand diagram, the points that represent the complex numbers z , $-\bar{z}$, z^{-1} and $-(z^{-1})$ necessarily lie at the vertices of a

A square B rectangle C parallelogram
 D rhombus E trapezium

- 55 Assume that the two vector equations $\mathbf{r}_1 = \mathbf{a}_1 + t\mathbf{d}_1$, $t \in \mathbb{R}$, and $\mathbf{r}_2 = \mathbf{a}_2 + s\mathbf{d}_2$, $s \in \mathbb{R}$, represent the same line ℓ , where ℓ does not pass through the origin. Which one of the following is *not* true?

A $\mathbf{d}_1 = k\mathbf{d}_2$ for some $k \in \mathbb{R}$ B $\mathbf{a}_2 = \mathbf{a}_1 + t\mathbf{d}_1$ for some $t \in \mathbb{R}$
 C $\mathbf{d}_2 = \mathbf{a}_1 + t\mathbf{d}_1$ for some $t \in \mathbb{R}$ D $\mathbf{a}_2 - \mathbf{a}_1 = k\mathbf{d}_2$ for some $k \in \mathbb{R}$
 E $\mathbf{a}_2 + \mathbf{d}_1$ is the position vector of a point on the line ℓ

- 56 A system of linear equations has an augmented matrix in row-echelon form as shown.

$$\begin{array}{l} x + y + z = 2 \\ x + 2y + kz = 4 \\ 2x + 3ky + 2z = 6 \end{array} \quad \left[\begin{array}{ccc|c} 1 & 1 & 1 & 2 \\ 0 & 1 & k-1 & 2 \\ 0 & 0 & (k-1)(2-3k) & 6(1-k) \end{array} \right]$$

Which one of the following is true?

- A For all values of k , this system of equations has no solutions.
 B There is only one value of k for which this system has a unique solution.
 C There are exactly two values of k for which this system has a unique solution.
 D There is only one value of k for which this system does not have a unique solution.
 E There are exactly two values of k for which this system does not have a unique solution.

9C Extended-response questions

- 1 a** Points A , B and P are collinear with B between A and P . The points A , B and P have position vectors \mathbf{a} , \mathbf{b} and \mathbf{r} respectively, relative to an origin O . If $\overrightarrow{AP} = \frac{3}{2}\overrightarrow{AB}$:
- express \overrightarrow{AP} in terms of \mathbf{a} and \mathbf{b}
 - express \mathbf{r} in terms of \mathbf{a} and \mathbf{b} .
- b** The points A , B and C have position vectors \mathbf{i} , $2\mathbf{i} + 2\mathbf{j}$ and $4\mathbf{i} + \mathbf{j}$ respectively.
- Find \overrightarrow{AB} and \overrightarrow{BC} .
 - Show that \overrightarrow{AB} and \overrightarrow{BC} have equal magnitudes.
 - Show that AB and BC are perpendicular.
 - Find the position vector of D such that $ABCD$ is a square.
- c** The triangle OAB is such that O is the origin, $\overrightarrow{OA} = 8\mathbf{i}$ and $\overrightarrow{OB} = 10\mathbf{j}$. The point P with position vector $\overrightarrow{OP} = x\mathbf{i} + y\mathbf{j} + z\mathbf{k}$ is equidistant from O , A and B and is at a distance of 2 above the triangle. Find x , y and z .
- 2 a** Let $S_1 = \{z : |z| \leq 2\}$ and $T_1 = \{z : \text{Im}(z) + \text{Re}(z) \geq 4\}$.
- On the same diagram, sketch S_1 and T_1 , clearly indicating which boundary points are included.
 - Let $d = |z_1 - z_2|$, where $z_1 \in S_1$ and $z_2 \in T_1$. Find the minimum value of d .
- b** Let $S_2 = \{z : |z - 1 - i| \leq 1\}$ and $T_2 = \{z : |z - 2 - i| \leq |z - i|\}$.
- On the same diagram, sketch S_2 and T_2 , clearly indicating which boundaries are included.
 - If z belongs to $S_2 \cap T_2$, find the maximum and minimum values of $|z|$.
- 3** $OACB$ is a trapezium with OB parallel to AC and $AC = 2OB$. Point D is the point of trisection of OC nearer to O .
- a** If $\mathbf{a} = \overrightarrow{OA}$ and $\mathbf{b} = \overrightarrow{OB}$, find in terms of \mathbf{a} and \mathbf{b} :
- \overrightarrow{BC}
 - \overrightarrow{BD}
 - \overrightarrow{DA}
- b** Hence prove that A , D and B are collinear.
- 4 a** If $\mathbf{a} = \mathbf{i} - 2\mathbf{j} + 2\mathbf{k}$ and $\mathbf{b} = 12\mathbf{j} - 5\mathbf{k}$, find:
- the magnitude of the angle between \mathbf{a} and \mathbf{b} to the nearest degree
 - the vector resolute of \mathbf{b} perpendicular to \mathbf{a}
 - real numbers x , y and z such that $x\mathbf{a} + y\mathbf{b} = 3\mathbf{i} - 30\mathbf{j} + z\mathbf{k}$.
- b** In triangle OAB , $\mathbf{a} = \overrightarrow{OA}$ and $\mathbf{b} = \overrightarrow{OB}$. Points P and Q are such that P is the point of trisection of AB nearer to B and $\overrightarrow{OQ} = 1.5\overrightarrow{OP}$.
- Find an expression for \overrightarrow{AQ} in terms of \mathbf{a} and \mathbf{b} .
 - Show that \overrightarrow{OA} is parallel to \overrightarrow{BQ} .

- 5 a** Show that if $2a + b - c = 0$ and $a - 4b - 2c = 0$, then $a : b : c = 2 : -1 : 3$.
- b** Assume that the vector $x\mathbf{i} + y\mathbf{j} + z\mathbf{k}$ is perpendicular to both $2\mathbf{i} + \mathbf{j} - 3\mathbf{k}$ and $\mathbf{i} - \mathbf{j} - \mathbf{k}$. Establish two equations in x , y and z , and find the ratio $x : y : z$.
- c** Hence, or otherwise, find any vector \mathbf{v} which is perpendicular to both $2\mathbf{i} + \mathbf{j} - 3\mathbf{k}$ and $\mathbf{i} - \mathbf{j} - \mathbf{k}$.
- d** Show that the vector $4\mathbf{i} + 5\mathbf{j} - 7\mathbf{k}$ is also perpendicular to vector \mathbf{v} .
- e** Find the values of s and t such that $4\mathbf{i} + 5\mathbf{j} - 7\mathbf{k}$ can be expressed in the form $s(2\mathbf{i} + \mathbf{j} - 3\mathbf{k}) + t(\mathbf{i} - \mathbf{j} - \mathbf{k})$.
- f** Show that any vector $\mathbf{r} = t(2\mathbf{i} + \mathbf{j} - 3\mathbf{k}) + s(\mathbf{i} - \mathbf{j} - \mathbf{k})$ is perpendicular to vector \mathbf{v} (where $t \in \mathbb{R}$ and $s \in \mathbb{R}$).
- 6** Consider a triangle with vertices O , A and B , where $\overrightarrow{OA} = \mathbf{a}$ and $\overrightarrow{OB} = \mathbf{b}$. Let θ be the angle between vectors \mathbf{a} and \mathbf{b} .
- a** Express $\cos \theta$ in terms of vectors \mathbf{a} and \mathbf{b} .
- b** Hence express $\sin \theta$ in terms of vectors \mathbf{a} and \mathbf{b} .
- c** Use the formula for the area of a triangle (area = $\frac{1}{2}ab \sin C$) to show that the area of triangle OAB is given by

$$\frac{1}{2} \sqrt{(\mathbf{a} \cdot \mathbf{a})(\mathbf{b} \cdot \mathbf{b}) - (\mathbf{a} \cdot \mathbf{b})^2}$$

- 7** In the quadrilateral $ABCD$, the points X and Y are the midpoints of the diagonals AC and BD respectively.
- a** Show that $\overrightarrow{BA} + \overrightarrow{BC} = 2\overrightarrow{BX}$.
- b** Show that $\overrightarrow{BA} + \overrightarrow{BC} + \overrightarrow{DA} + \overrightarrow{DC} = 4\overrightarrow{YX}$.
- 8** The position vectors of the vertices of a triangle ABC , relative to a given origin O , are \mathbf{a} , \mathbf{b} and \mathbf{c} . Let P and Q be points on the line segments AB and AC respectively such that $AP : PB = 1 : 2$ and $AQ : QC = 2 : 1$. Let R be the point on the line segment PQ such that $PR : RQ = 2 : 1$.
- a** Prove that $\overrightarrow{OR} = \frac{4}{9}\mathbf{a} + \frac{1}{9}\mathbf{b} + \frac{4}{9}\mathbf{c}$.
- b** Let M be the midpoint of AC . Prove that R lies on the median BM .
- c** Find $BR : RM$.
- 9** The points A and B have position vectors \mathbf{a} and \mathbf{b} respectively, relative to an origin O . The point C lies on AB between A and B , and is such that $AC : CB = 2 : 1$, and D is the midpoint of OC . The line AD meets OB at E .
- a** Find in terms of \mathbf{a} and \mathbf{b} :
- i** \overrightarrow{OC} **ii** \overrightarrow{AD}
- b** Find the ratios:
- i** $OE : EB$ **ii** $AE : ED$

- 10** The position vectors of the vertices A , B and C of a triangle, relative to an origin O , are \mathbf{a} , \mathbf{b} and \mathbf{c} respectively. The side BC is extended to D so that $BC = CD$. The point X divides side AB in the ratio $2 : 1$, and the point Y divides side AC in the ratio $4 : 1$. That is, $AX : XB = 2 : 1$ and $AY : YC = 4 : 1$.

a Express in terms of \mathbf{a} , \mathbf{b} and \mathbf{c} :

i \overrightarrow{OD} **ii** \overrightarrow{OX} **iii** \overrightarrow{OY}

b Show that D , X and Y are collinear.

- 11** Points A , B , C and D have position vectors $\mathbf{j} + 2\mathbf{k}$, $-\mathbf{i} - \mathbf{j}$, $4\mathbf{i} + \mathbf{k}$ and $3\mathbf{i} + \mathbf{j} + 2\mathbf{k}$ respectively.

a Prove that the triangle ABC is right-angled.

b Prove that the triangle ABD is isosceles.

c Show that BD passes through the midpoint, E , of AC and find the ratio $BE : ED$.

- 12** The line segment AB is the common perpendicular joining the two skew lines AP and BQ . The midpoint of AB is C , and the midpoint of PQ is R . The position vectors of the points A , B , P and Q are \mathbf{a} , \mathbf{b} , \mathbf{p} and \mathbf{q} respectively.

a Find each of the following in terms of \mathbf{a} , \mathbf{b} , \mathbf{p} and \mathbf{q} :

i \overrightarrow{AB} **ii** \overrightarrow{PQ} **iii** \overrightarrow{CR}

b Hence show that CR is perpendicular to AB .

- 13** Let \mathbf{a} , \mathbf{b} and \mathbf{c} be non-zero vectors in three dimensions such that

$$\mathbf{a} \times \mathbf{b} = 3\mathbf{a} \times \mathbf{c}$$

a Show that there exists $k \in \mathbb{R}$ such that $\mathbf{b} - 3\mathbf{c} = k\mathbf{a}$.

b Given that $|\mathbf{a}| = |\mathbf{c}| = 1$, $|\mathbf{b}| = 3$ and the angle between \mathbf{b} and \mathbf{c} is $\arccos\left(\frac{1}{3}\right)$, find:

i $\mathbf{b} \cdot \mathbf{c}$ **ii** $|\mathbf{b} - 3\mathbf{c}|$ **iii** the possible values of k .

c Hence find the cosine of the angle between vectors \mathbf{a} and \mathbf{c} .

- 14 a** Let A , B and C be points in three-dimensional space with position vectors \mathbf{a} , \mathbf{b} and \mathbf{c} respectively. Given that A , B and C are not collinear, prove that the plane ABC can be represented by the vector equation

$$\mathbf{r} = \lambda\mathbf{a} + \mu\mathbf{b} + \nu\mathbf{c}, \quad \text{where } \lambda, \mu, \nu \in \mathbb{R} \text{ with } \lambda + \mu + \nu = 1$$

b For each of the following, write down a vector equation of the plane ABC in the form established in part **a**:

i $A(1, 1, 1)$, $B(1, -1, 1)$, $C(1, 1, -1)$

ii $A(1, 1, 1)$, $B(-1, -2, 3)$, $C(2, 1, -2)$

c Find a vector equation (using just one parameter $t \in \mathbb{R}$) for the line of intersection of the two planes given by

$$\mathbf{r}_1 = \lambda_1\mathbf{i} + 2\mu_1\mathbf{j} + 3\nu_1\mathbf{k}, \quad \text{where } \lambda_1, \mu_1, \nu_1 \in \mathbb{R} \text{ with } \lambda_1 + \mu_1 + \nu_1 = 1$$

$$\mathbf{r}_2 = 2\lambda_2\mathbf{i} + \mu_2\mathbf{j} + 2\nu_2\mathbf{k}, \quad \text{where } \lambda_2, \mu_2, \nu_2 \in \mathbb{R} \text{ with } \lambda_2 + \mu_2 + \nu_2 = 1$$

- 15** A vector equation of a plane Π is $\mathbf{r} \cdot \mathbf{n} = k$.
- a** Let ℓ be a line with vector equation $\mathbf{r} = \mathbf{a} + t\mathbf{b}$, $t \in \mathbb{R}$. Given that $\mathbf{b} \cdot \mathbf{n} \neq 0$, show that the plane Π meets the line ℓ at the point with position vector

$$\frac{(\mathbf{b} \cdot \mathbf{n})\mathbf{a} - (\mathbf{a} \cdot \mathbf{n})\mathbf{b} + k\mathbf{b}}{\mathbf{b} \cdot \mathbf{n}}$$

- b** Let P be a point, with position vector \mathbf{p} , such that P does not lie on the plane Π .
- i** Using part **a**, express the position vector of the point where the plane Π meets the line through P perpendicular to Π in terms of \mathbf{p} , \mathbf{n} and k .
- ii** Express the distance from the point P to the plane Π in terms of \mathbf{p} , \mathbf{n} and k .
- 16** Consider the system of equations

$$x + y + 2z = a$$

$$x + z = b$$

$$2x + y + 3z = c$$

- a** Find the relationship between a , b and c if the system has at least one solution.
- b** Under the conditions found in part **a**, find a vector equation of the line of intersection of the three planes defined by these three equations.
- c** Solve the equations if $a = b$.

- 17** The general equation of a circle in the Cartesian plane is $x^2 + y^2 + ax + by + c = 0$.

- a** The three points $(3, -1)$, $(-1, -2)$ and $(4, -5)$ lie on a circle.
- i** Write down three linear equations in a , b and c .
- ii** Represent these three equations as an augmented matrix.
- iii** Find the centre and radius of the circle.
- b** Consider the three points $(3, -1)$, $(-1, -2)$ and $(0, k)$.
- i** By substituting these values into the equation $x^2 + y^2 + ax + by + c = 0$, write down three linear equations in a , b and c .
- ii** Represent these three equations as an augmented matrix.
- iii** Find the values of k for which these three points lie on a circle.
- c** Find the values of k for which the points $(3, -1)$, $(-1, -2)$ and $(1, k)$ lie on a circle.

- 18 a** For $\alpha = 1 - \sqrt{3}i$, write the product of $z - \alpha$ and $z - \bar{\alpha}$ as a quadratic expression in z with real coefficients, where $\bar{\alpha}$ denotes the complex conjugate of α .

- b i** Express α in polar form.
- ii** Find α^2 and α^3 .
- iii** Show that α is a solution of the equation $z^3 - z^2 + 2z + 4 = 0$, and find all three solutions of this equation.
- c** On an Argand diagram, plot the three points corresponding to the three solutions. Let A be the point in the first quadrant, let B be the point on the real axis and let C be the third point.
- i** Find the lengths AB and CB . **ii** Describe the triangle ABC .

- 19 a** If $z = 1 + \sqrt{2}i$, express $p = z + \frac{1}{z}$ and $q = z - \frac{1}{z}$ in the form $a + bi$.
- b** On an Argand diagram, let P and Q be the points representing p and q respectively. Let O be the origin, let M be the midpoint of PQ and let G be the point on the line segment OM with $OG = \frac{2}{3}OM$. Denote vectors \overrightarrow{OP} and \overrightarrow{OQ} by \mathbf{a} and \mathbf{b} respectively. Find each of the following vectors in terms of \mathbf{a} and \mathbf{b} :
- i** \overrightarrow{PQ} **ii** \overrightarrow{OM} **iii** \overrightarrow{OG} **iv** \overrightarrow{GP} **v** \overrightarrow{GQ}
- c** Prove that angle PGQ is a right angle.
- 20 a** Find the linear factors of $z^2 + 4$.
- b** Express $z^4 + 4$ as the product of two quadratic factors in \mathbb{C} .
- c** Show that:
- i** $(1 + i)^2 = 2i$ **ii** $(1 - i)^2 = -2i$
- d** Use the results of **c** to factorise $z^4 + 4$ into linear factors.
- e** Hence factorise $z^4 + 4$ into two quadratic factors with real coefficients.
- 21 a** Let $z_1 = 1 + 3i$ and $z_2 = 2 - i$. Show that $|z_1 - z_2|$ is the distance between the points z_1 and z_2 on an Argand diagram.
- b** Describe the locus of z on an Argand diagram such that $|z - (2 - i)| = \sqrt{5}$.
- c** Describe the locus of z such that $|z - (1 + 3i)| = |z - (2 - i)|$.
- 22** Let $z = 2 + i$.
- a** Express z^3 in the form $x + yi$, where x and y are integers.
- b** Let the polar form of $z = 2 + i$ be $r(\cos \alpha + i \sin \alpha)$. Using the polar form of z^3 , but without evaluating α , find the value of:
- i** $\cos(3\alpha)$ **ii** $\sin(3\alpha)$
- 23** The cube roots of unity are often denoted by 1 , w and w^2 , where $w = -\frac{1}{2} + \frac{\sqrt{3}}{2}i$ and $w^2 = -\frac{1}{2} - \frac{\sqrt{3}}{2}i$.
- a i** Illustrate these three numbers on an Argand diagram.
- ii** Show that $(w^2)^2 = w$.
- b** By factorising $z^3 - 1$, show that $w^2 + w + 1 = 0$.
- c** Evaluate:
- i** $(1 + w)(1 + w^2)$
- ii** $(1 + w^2)^3$
- d** Form the quadratic equation whose solutions are:
- i** $2 + w$ and $2 + w^2$
- ii** $3w - w^2$ and $3w^2 - w$
- e** Find the possible values of the expression $1 + w^n + w^{2n}$ for $n \in \mathbb{N}$.

- 24 a** Let $z^5 - 1 = (z - 1)P(z)$, where $P(z)$ is a polynomial. Find $P(z)$ by division.
- b** Show that $z = \text{cis}\left(\frac{2\pi}{5}\right)$ is a solution of the equation $z^5 - 1 = 0$.
- c** Hence find another complex solution of the equation $z^5 - 1 = 0$.
- d** Find all the complex solutions of $z^5 - 1 = 0$.
- e** Hence factorise $P(z)$ as a product of two quadratic polynomials with real coefficients.

- 25 a** Two complex variables w and z are related by

$$w = \frac{az + b}{z + c}$$

where $a, b, c \in \mathbb{R}$. Given that $w = 3i$ when $z = -3i$ and that $w = 1 - 4i$ when $z = 1 + 4i$, find the values of a, b and c .

- b** Let $z = x + yi$. Show that if $w = \bar{z}$, then z lies on a circle of centre $(4, 0)$, and state the radius of this circle.
- 26 a** Use De Moivre's theorem to show that $(1 + i \tan \theta)^5 = \frac{\text{cis}(5\theta)}{\cos^5(\theta)}$.
- b** Hence find expressions for $\cos(5\theta)$ and $\sin(5\theta)$ in terms of $\tan \theta$ and $\cos \theta$.
- c** Show that $\tan(5\theta) = \frac{5t - 10t^3 + t^5}{1 - 10t^2 + 5t^4}$ where $t = \tan \theta$.
- d** Use the result of **c** and an appropriate substitution to show that $\tan\left(\frac{\pi}{5}\right) = (5 - 2\sqrt{5})^{\frac{1}{2}}$.
- 27 a** Express, in terms of θ , the solutions α and β of the equation $z + z^{-1} = 2 \cos \theta$.
- b** If P and Q are points on the Argand diagram representing $\alpha^n + \beta^n$ and $\alpha^n - \beta^n$ respectively, show that PQ is of constant length for $n \in \mathbb{N}$.

- 28** Let S and T be the subsets of the complex plane given by

$$S = \left\{ z : \sqrt{2} \leq |z| \leq 3 \text{ and } \frac{\pi}{2} < \text{Arg } z \leq \frac{3\pi}{4} \right\}$$

$$T = \{ z : z\bar{z} + 2 \text{Re}(iz) \leq 0 \}$$

- a** Sketch S on an Argand diagram.
- b** Find $\{ z : z \in S \text{ and } z = x + yi \text{ where } x \text{ and } y \text{ are integers} \}$.
- c** On a separate diagram, sketch $S \cap T$.
- 29 a** Let $A = \left\{ z : \text{Arg } z = \frac{\pi}{4} \right\}$ and $B = \left\{ z : \text{Arg}(z - 4) = \frac{3\pi}{4} \right\}$.
Sketch A and B on the same Argand diagram, clearly labelling $A \cap B$.
- b** Let $C = \left\{ z : \left| \frac{z - \bar{z}}{z + \bar{z}} \right| \leq 1 \right\}$ and $D = \{ z : z^2 + (\bar{z})^2 \leq 2 \}$.
Sketch $C \cap D$ on an Argand diagram.

- 30** In the tetrahedron shown, $\vec{OB} = \mathbf{i}$, $\vec{OC} = -\mathbf{i} + 3\mathbf{j}$ and $\vec{BA} = \sqrt{\lambda}\mathbf{k}$.

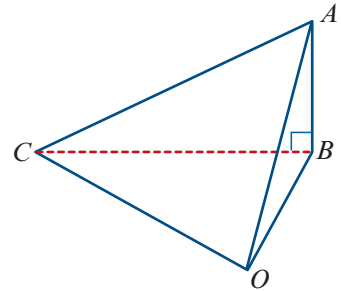

- a** Express \vec{OA} and \vec{CA} in terms of \mathbf{i} , \mathbf{j} , \mathbf{k} and $\sqrt{\lambda}$.
- b** Find the magnitude of $\angle CBO$ to the nearest degree.
- c** Find the value of λ , if the magnitude of $\angle OAC$ is 30° .
- 31 a** $ABCD$ is a tetrahedron in which AB is perpendicular to CD and AD is perpendicular to BC . Prove that AC is perpendicular to BD . Let \mathbf{a} , \mathbf{b} , \mathbf{c} and \mathbf{d} be the position vectors of the four vertices.
- b** Let $ABCD$ be a regular tetrahedron. The intersection point of the perpendicular bisectors of the edges of a triangle is called the circumcentre of the triangle. Let X , Y , Z and W be the circumcentres of faces ABC , ACD , ABD and BCD respectively. The vectors \mathbf{a} , \mathbf{b} , \mathbf{c} and \mathbf{d} are the position vectors of the four vertices.
- i** Find the position vectors of X , Y , Z and W .
- ii** Find the vectors \vec{DX} , \vec{BY} , \vec{CZ} and \vec{AW} .
- iii** Let P be a point on DX such that $\vec{DP} = \frac{3}{4}\vec{DX}$. Find the position vector of P .
- iv** Hence find the position vectors of the points Q , R and S on BY , CZ and AW respectively such that $\vec{BQ} = \frac{3}{4}\vec{BY}$, $\vec{CR} = \frac{3}{4}\vec{CZ}$ and $\vec{AS} = \frac{3}{4}\vec{AW}$.
- v** Explain the geometric significance of results **iii** and **iv**.

- 32** Consider the two lines ℓ_1 and ℓ_2 defined as follows:

$$\ell_1: \mathbf{r}_1 = \mathbf{a}_1 + \lambda\mathbf{d}_1, \lambda \in \mathbb{R}, \quad \text{where } \mathbf{a}_1 = -\mathbf{i} + 4\mathbf{j} + 4\mathbf{k} \quad \text{and} \quad \mathbf{d}_1 = -4\mathbf{i} + \mathbf{j} + \mathbf{k}$$

$$\ell_2: \mathbf{r}_2 = \mathbf{a}_2 + \mu\mathbf{d}_2, \mu \in \mathbb{R}, \quad \text{where } \mathbf{a}_2 = -4\mathbf{i} + 2\mathbf{j} + 3\mathbf{k} \quad \text{and} \quad \mathbf{d}_2 = 6\mathbf{i} - \mathbf{j} - 2\mathbf{k}$$

- a** Show that the lines ℓ_1 and ℓ_2 do not intersect.

Since the lines ℓ_1 and ℓ_2 are not parallel, it now follows that they are skew lines. There is a point P on ℓ_1 and a point Q on ℓ_2 such that PQ is perpendicular to both lines ℓ_1 and ℓ_2 . We have $\vec{OP} = \mathbf{a}_1 + s\mathbf{d}_1$ and $\vec{OQ} = \mathbf{a}_2 + t\mathbf{d}_2$, for some $s, t \in \mathbb{R}$.

- b** Express the vector \vec{PQ} in component form in terms of s and t .

Since PQ is perpendicular to both lines ℓ_1 and ℓ_2 , we must have $\vec{PQ} = m(\mathbf{d}_1 \times \mathbf{d}_2)$, for some $m \in \mathbb{R}$.

- c** Find $\mathbf{d}_1 \times \mathbf{d}_2$, and hence express the vector \vec{PQ} in component form in terms of m .

- d** Use parts **b** and **c** to obtain three linear equations in s , t and m .

- e** Solve this system of equations for s , t and m .

- f** Hence find the coordinates of the points P and Q .

- g** The distance between the skew lines ℓ_1 and ℓ_2 is given by $|\vec{PQ}|$. Find this distance.

10

Differentiation and rational functions

Objectives

- ▶ To review differentiation.
- ▶ To find the derivative of the function $y = \ln |x|$.
- ▶ To use the rule $\frac{dy}{dx} = \frac{1}{\frac{dx}{dy}}$ to obtain the derivative of a function of the form $x = f(y)$.
- ▶ To find the derivatives of the **inverse circular functions**.
- ▶ To apply the chain rule to problems involving **related rates**.
- ▶ To apply the chain rule to parametrically defined relations.
- ▶ To sketch the graphs of **rational functions**.
- ▶ To use **implicit differentiation**.

In this chapter we review the techniques of differentiation that you have met in Mathematical Methods Year 12. We also introduce important new techniques that will be used throughout the remainder of the book. Differentiation and integration are used in each of the following chapters, up to the chapter on statistical inference.

In Mathematical Methods Year 12, you have used the second derivative for graph sketching. In this chapter we apply these techniques to sketch the graphs of rational functions such as

$$f(x) = \frac{x^2 + 2x + 3}{x^2 + 4x - 1}$$

In general, a rational function is the quotient of two polynomial functions.

We also investigate techniques for finding the gradient at a point on a curve that is not the graph of a function:

- For a curve defined by parametric equations, we will use related rates.
- For a curve defined by a Cartesian equation, we will use implicit differentiation.

10A Differentiation

The derivative of a function f is denoted by f' and is defined by

$$f'(x) = \lim_{h \rightarrow 0} \frac{f(x+h) - f(x)}{h}$$

The derivative f' is also known as the gradient function.

If $(a, f(a))$ is a point on the graph of $y = f(x)$, then the gradient of the graph at that point is $f'(a)$.

If the line ℓ is the tangent to the graph of $y = f(x)$ at the point $(a, f(a))$ and ℓ makes an angle of θ with the positive direction of the x -axis, as shown, then

$$f'(a) = \text{gradient of } \ell = \tan \theta$$

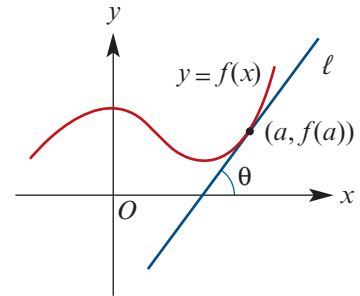

► Review of differentiation

Here we summarise basic derivatives and rules for differentiation covered in Mathematical Methods Year 12.

The use of a CAS calculator for performing differentiation is also covered in Mathematical Methods.

$f(x)$	$f'(x)$
a	0
x^n	nx^{n-1}
$\sin x$	$\cos x$
$\cos x$	$-\sin x$
e^x	e^x
$\ln x$	$\frac{1}{x}$

where a is a constant

where $n \in \mathbb{R} \setminus \{0\}$

for $x > 0$

Product rule

- If $f(x) = g(x)h(x)$, then

$$f'(x) = g'(x)h(x) + g(x)h'(x)$$

- If $y = uv$, then

$$\frac{dy}{dx} = u \frac{dv}{dx} + v \frac{du}{dx}$$

Quotient rule

- If $f(x) = \frac{g(x)}{h(x)}$, then

$$f'(x) = \frac{g'(x)h(x) - g(x)h'(x)}{(h(x))^2}$$

- If $y = \frac{u}{v}$, then

$$\frac{dy}{dx} = \frac{v \frac{du}{dx} - u \frac{dv}{dx}}{v^2}$$

Chain rule

- If $f(x) = h(g(x))$, then

$$f'(x) = h'(g(x))g'(x)$$

- If $y = h(u)$ and $u = g(x)$, then

$$\frac{dy}{dx} = \frac{dy}{du} \frac{du}{dx}$$

Example 1Differentiate each of the following with respect to x :

a $\sqrt{x} \sin x$

b $\frac{x^2}{\sin x}$

c $\cos(x^2 + 1)$

Solution

a Let $f(x) = \sqrt{x} \sin x$.

Applying the product rule:

$$\begin{aligned} f'(x) &= \frac{1}{2}x^{-\frac{1}{2}} \sin x + x^{\frac{1}{2}} \cos x \\ &= \frac{\sqrt{x} \sin x}{2x} + \sqrt{x} \cos x, \quad x > 0 \end{aligned}$$

b Let $h(x) = \frac{x^2}{\sin x}$.

Applying the quotient rule:

$$h'(x) = \frac{2x \sin x - x^2 \cos x}{\sin^2 x}$$

c Let $y = \cos(x^2 + 1)$.

Let $u = x^2 + 1$. Then $y = \cos u$.

By the chain rule:

$$\begin{aligned} \frac{dy}{dx} &= \frac{dy}{du} \frac{du}{dx} \\ &= -\sin u \cdot 2x \\ &= -2x \sin(x^2 + 1) \end{aligned}$$

► The derivative of $\tan(kx)$ Let $f(x) = \tan(kx)$. Then $f'(x) = k \sec^2(kx)$.

Proof Let $f(x) = \tan(kx) = \frac{\sin(kx)}{\cos(kx)}$.

The quotient rule yields

$$\begin{aligned} f'(x) &= \frac{k \cos(kx) \cos(kx) + k \sin(kx) \sin(kx)}{\cos^2(kx)} \\ &= \frac{k(\cos^2(kx) + \sin^2(kx))}{\cos^2(kx)} \\ &= k \sec^2(kx) \end{aligned}$$

Example 2Differentiate each of the following with respect to x :

a $\tan(5x^2 + 3)$

b $\tan^3 x$

c $\sec^2(3x)$

Solution

a Let $f(x) = \tan(5x^2 + 3)$.

By the chain rule with $g(x) = 5x^2 + 3$, we have

$$\begin{aligned} f'(x) &= \sec^2(5x^2 + 3) \cdot 10x \\ &= 10x \sec^2(5x^2 + 3) \end{aligned}$$

b Let $f(x) = \tan^3 x = (\tan x)^3$.

By the chain rule with $g(x) = \tan x$, we have

$$\begin{aligned} f'(x) &= 3(\tan x)^2 \cdot \sec^2 x \\ &= 3 \tan^2 x \sec^2 x \end{aligned}$$

c Let $y = \sec^2(3x)$

$$= \tan^2(3x) + 1 \quad (\text{using the Pythagorean identity})$$

$$= (\tan(3x))^2 + 1$$

Let $u = \tan(3x)$. Then $y = u^2 + 1$ and the chain rule gives

$$\begin{aligned} \frac{dy}{dx} &= \frac{dy}{du} \frac{du}{dx} \\ &= 2u \cdot 3 \sec^2(3x) \\ &= 6 \tan(3x) \sec^2(3x) \end{aligned}$$

► Operator notation

Sometimes it is appropriate to use notation which emphasises that differentiation is an operation on an expression. The derivative of $f(x)$ can be denoted by $\frac{d}{dx}(f(x))$.

Example 3

Find:

a $\frac{d}{dx}(x^2 + 2x + 3)$

b $\frac{d}{dx}(e^{x^2})$

c $\frac{d}{dz}(\sin^2(z))$

Solution

a $\frac{d}{dx}(x^2 + 2x + 3) = 2x + 2$

b Let $y = e^{x^2}$ and $u = x^2$. Then $y = e^u$.

The chain rule gives

$$\begin{aligned} \frac{dy}{dx} &= \frac{dy}{du} \frac{du}{dx} \\ &= e^u \cdot 2x \\ &= 2xe^{x^2} \end{aligned}$$

i.e. $\frac{d}{dx}(e^{x^2}) = 2xe^{x^2}$

c Let $y = \sin^2(z)$ and $u = \sin z$. Then $y = u^2$.

The chain rule gives

$$\begin{aligned} \frac{dy}{dz} &= \frac{dy}{du} \frac{du}{dz} \\ &= 2u \cos z \\ &= 2 \sin z \cos z \\ &= \sin(2z) \end{aligned}$$

► The derivative of $\ln|x|$

The function

$$f: \mathbb{R} \setminus \{0\} \rightarrow \mathbb{R}, f(x) = \ln|x|$$

is very important in this course.

The graph of the function is shown opposite.

The derivative of this function is determined in the following example.

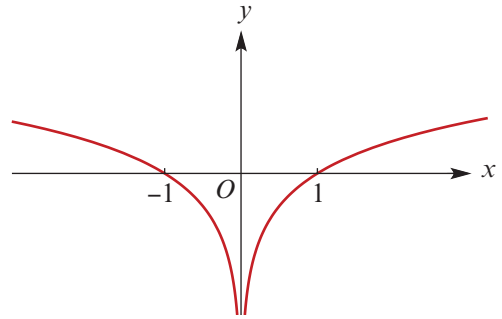

Example 4

- a** Find $\frac{d}{dx}(\ln|x|)$ for $x \neq 0$.
- b** Find $\frac{d}{dx}(\ln|\sec x|)$ for $x \notin \left\{ \frac{(2k+1)\pi}{2} : k \in \mathbb{Z} \right\}$.

Solution

a Let $y = \ln|x|$.

If $x > 0$, then $y = \ln x$, so

$$\frac{dy}{dx} = \frac{1}{x}$$

If $x < 0$, then $y = \ln(-x)$, so the chain rule gives

$$\frac{dy}{dx} = \frac{1}{-x} \times (-1) = \frac{1}{x}$$

Hence

$$\frac{d}{dx}(\ln|x|) = \frac{1}{x} \quad \text{for } x \neq 0$$

b Let $y = \ln|\sec x|$

$$= \ln \left| \frac{1}{\cos x} \right|$$

$$= \ln \left(\frac{1}{|\cos x|} \right)$$

$$= -\ln|\cos x|$$

Let $u = \cos x$. Then $y = -\ln|u|$.

By the chain rule:

$$\frac{dy}{dx} = \frac{dy}{du} \frac{du}{dx}$$

$$= -\frac{1}{u} \times (-\sin x)$$

$$= \frac{\sin x}{\cos x}$$

$$= \tan x$$

Derivative of $\ln|x|$

Let $f: \mathbb{R} \setminus \{0\} \rightarrow \mathbb{R}, f(x) = \ln|x|$. Then $f'(x) = \frac{1}{x}$.

► Second derivatives

In Mathematical Methods Year 12, you have used the second derivative for graph sketching. Recall that the second derivative of a function is just the derivative of the derivative.

- The second derivative of a function f is denoted by f'' .
- The second derivative of y with respect to x is denoted by $\frac{d^2y}{dx^2}$.

For the graph of a function $y = f(x)$, the second derivative can tell us how the gradient of the curve is changing over an interval (a, b) :

- If $f''(x) > 0$ for all $x \in (a, b)$, then the gradient of the curve is increasing over the interval (a, b) . The curve is said to be **concave up**.
- If $f''(x) < 0$ for all $x \in (a, b)$, then the gradient of the curve is decreasing over the interval (a, b) . The curve is said to be **concave down**.

Point of inflection

A point where a curve changes from concave up to concave down or from concave down to concave up is called a **point of inflection**. That is, a point of inflection occurs where the sign of the second derivative changes.

For example, in the graph shown on the right, there are points of inflection at $x = c$ and $x = d$.

- The curve is concave up on the intervals $(-\infty, c)$ and (d, ∞) .
- The curve is concave down on the interval (c, d) .

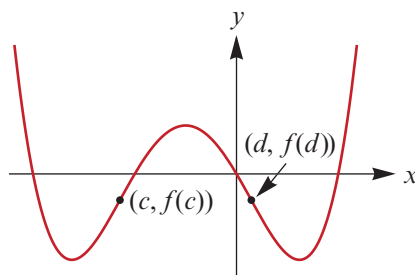

Note: At a point of inflection of a twice differentiable function f , we must have $f''(x) = 0$. However, this condition does not necessarily guarantee a point of inflection. At a point of inflection, there must also be a change of concavity.

Exercise 10A

Skillsheet

1 Find the derivative of each of the following with respect to x :

Example 1

- a** $x^5 \sin x$ **b** $\sqrt{x} \cos x$ **c** $e^x \cos x$ **d** $x^3 e^x$ **e** $\sin x \cos x$

Example 2

2 Find the derivative of each of the following with respect to x :

- a** $e^x \tan x$ **b** $x^4 \tan x$ **c** $\tan x \ln x$ **d** $\sin x \tan x$ **e** $\sqrt{x} \tan x$

3 Find the derivative of each of the following using the quotient rule:

- a** $\frac{x}{\ln x}$ **b** $\frac{\sqrt{x}}{\tan x}$ **c** $\frac{e^x}{\tan x}$ **d** $\frac{\tan x}{\ln x}$
e $\frac{\sin x}{x^2}$ **f** $\frac{\tan x}{\cos x}$ **g** $\frac{\cos x}{e^x}$ **h** $\frac{\cos x}{\sin x} (= \cot x)$

4 Find the derivative of each of the following using the chain rule:

- a** $\tan(x^2 + 1)$ **b** $\sin^2 x$ **c** $e^{\tan x}$ **d** $\tan^5 x$
e $\sin(\sqrt{x})$ **f** $\sqrt{\tan x}$ **g** $\cos\left(\frac{1}{x}\right)$ **h** $\sec^2 x$
i $\tan\left(\frac{x}{4}\right)$ **j** $\cot x$ **Hint:** Use $\cot x = \tan\left(\frac{\pi}{2} - x\right)$.

5 Use appropriate techniques to find the derivative of each of the following:

- a** $\tan(kx)$, $k \in \mathbb{R}$ **b** $e^{\tan(2x)}$ **c** $\tan^2(3x)$ **d** $\ln(x)e^{\sin x}$
e $\sin^3(x^2)$ **f** $\frac{e^{3x+1}}{\cos x}$ **g** $e^{3x} \tan(2x)$ **h** $\sqrt{x} \tan(\sqrt{x})$
i $\frac{\tan^2 x}{(x+1)^3}$ **j** $\sec^2(5x^2)$

6 Find $\frac{dy}{dx}$ for each of the following:

- a** $y = (x-1)^5$ **b** $y = \ln(4x)$ **c** $y = e^x \tan(3x)$ **d** $y = e^{\cos x}$
e $y = \cos^3(4x)$ **f** $y = (\sin x + 1)^4$ **g** $y = \sin(2x) \cos x$ **h** $y = \frac{x^2 + 1}{x}$
i $y = \frac{x^3}{\sin x}$ **j** $y = \frac{1}{x \ln x}$

Example 3

7 For each of the following, determine the derivative:

- a** $\frac{d}{dx}(x^3)$ **b** $\frac{d}{dy}(2y^2 + 10y)$ **c** $\frac{d}{dz}(\cos^2 z)$
d $\frac{d}{dx}(e^{\sin^2 x})$ **e** $\frac{d}{dz}(1 - \tan^2 z)$ **f** $\frac{d}{dy}(\operatorname{cosec}^2 y)$

Example 4

8 For each of the following, find the derivative with respect to x :

- a** $\ln|2x + 1|$ **b** $\ln|-2x + 1|$ **c** $\ln|\sin x|$
d $\ln|\sec x + \tan x|$ **e** $\ln|\operatorname{cosec} x + \tan x|$ **f** $\ln\left|\tan\left(\frac{1}{2}x\right)\right|$
g $\ln|\operatorname{cosec} x - \cot x|$ **h** $\ln|x + \sqrt{x^2 - 4}|$ **i** $\ln|x + \sqrt{x^2 + 4}|$

9 Let $f(x) = \tan\left(\frac{x}{2}\right)$. Find the gradient of the graph of $y = f(x)$ at the point where:

- a** $x = 0$ **b** $x = \frac{\pi}{3}$ **c** $x = \frac{\pi}{2}$

10 Let $f: \left(-\frac{\pi}{2}, \frac{\pi}{2}\right) \rightarrow \mathbb{R}$, $f(x) = \tan x$.

- a** Find the coordinates of the points on the graph where the gradient is 4.
b Find the equation of the tangent at each of these points.

11 Let $f: \left(-\frac{\pi}{2}, \frac{\pi}{2}\right) \rightarrow \mathbb{R}$, $f(x) = \tan x - 8 \sin x$.

- a** **i** Find the stationary points on the graph of $y = f(x)$.
ii State the nature of each of the stationary points.
b Sketch the graph of $y = f(x)$.

- 12** Let $f: \left(-\frac{\pi}{2}, \frac{\pi}{2}\right) \rightarrow \mathbb{R}$, $f(x) = e^x \sin x$.
- Find the gradient of $y = f(x)$ when $x = \frac{\pi}{4}$.
 - Find the coordinates of the point where the gradient is zero.
- 13** Let $f: \left(-\frac{\pi}{4}, \frac{\pi}{4}\right) \rightarrow \mathbb{R}$, $f(x) = \tan(2x)$. The tangent to the graph of $y = f(x)$ at $x = a$ makes an angle of 70° with the positive direction of the x -axis. Find the value(s) of a .
- 14** Let $f(x) = \sec\left(\frac{x}{4}\right)$.
- Find $f'(x)$.
 - Find $f'(\pi)$.
 - Find the equation of the tangent to $y = f(x)$ at the point where $x = \pi$.
- 15** Find the second derivative of each of the following:
- $(2x + 5)^8$
 - $\sin(2x)$
 - $\cos\left(\frac{x}{3}\right)$
 - $\tan x$
 - e^{-4x}
 - $\ln(6x)$
 - $\ln(\sin x)$
 - $\tan(1 - 3x)$
 - $\sec\left(\frac{x}{3}\right)$
 - $\operatorname{cosec}\left(\frac{x}{4}\right)$
- 16** Consider the graph of $y = \frac{1}{1 + x + x^2}$.
- Find the coordinates of the points of inflection.
 - Find the coordinates of the point of intersection of the tangents at the points of inflection.
- 17** For each of the following functions, determine the coordinates of any points of inflection and the gradient of the graph at these points:
- $y = \frac{x + 1}{x - 1}$
 - $y = \frac{x - 2}{(x + 2)^2}$



10B Derivatives of $x = f(y)$

From the chain rule:

$$\frac{dy}{dx} = \frac{dy}{du} \times \frac{du}{dx}$$

For the special case where $y = x$, this gives

$$\frac{dx}{dx} = \frac{dx}{du} \times \frac{du}{dx}$$

$$\therefore 1 = \frac{dx}{du} \times \frac{du}{dx}$$

provided both derivatives exist.

This is restated in the standard form by replacing u with y in the formula:

$$\frac{dx}{dy} \times \frac{dy}{dx} = 1$$

We obtain the following useful result.

$$\frac{dy}{dx} = \frac{1}{\frac{dx}{dy}} \quad \text{provided } \frac{dx}{dy} \neq 0$$

Note: We are assuming that $x = f(y)$ is a one-to-one function.

Example 5

Given $x = y^3$, find $\frac{dy}{dx}$.

Solution

We have

$$\frac{dx}{dy} = 3y^2$$

Hence

$$\frac{dy}{dx} = \frac{1}{3y^2}, \quad y \neq 0$$

Explanation

The power of this method can be appreciated by comparing it with an alternative approach as follows.

Let $x = y^3$. Then $y = \sqrt[3]{x} = x^{\frac{1}{3}}$.

Hence

$$\frac{dy}{dx} = \frac{1}{3}x^{-\frac{2}{3}}$$

$$\text{i.e. } \frac{dy}{dx} = \frac{1}{3\sqrt[3]{x^2}}, \quad x \neq 0$$

Note that $\frac{1}{3y^2} = \frac{1}{3\sqrt[3]{x^2}}$.

While the derivative expressed in terms of x is the familiar form, it is no less powerful when it is found in terms of y .

Note: Here x is a one-to-one function of y .

Example 6

Find the gradient of the curve $x = y^2 - 4y$ at the point where $y = 3$.

Solution

$$x = y^2 - 4y$$

$$\frac{dx}{dy} = 2y - 4$$

$$\therefore \frac{dy}{dx} = \frac{1}{2y - 4}, \quad y \neq 2$$

Hence the gradient at $y = 3$ is $\frac{1}{2}$.

Note: Here x is not a one-to-one function of y , but it is for $y \geq 2$, which is where we are interested in the curve for this example. In the next example, we can consider two one-to-one functions of y . One with domain $y \geq 2$ and the other with domain $y \leq 2$.

Example 7

Find the gradient of the curve $x = y^2 - 4y$ at $x = 5$.

Solution

$$x = y^2 - 4y$$

$$\frac{dx}{dy} = 2y - 4$$

$$\therefore \frac{dy}{dx} = \frac{1}{2y - 4}, \quad y \neq 2$$

Substituting $x = 5$ into $x = y^2 - 4y$ yields

$$y^2 - 4y = 5$$

$$y^2 - 4y - 5 = 0$$

$$(y - 5)(y + 1) = 0$$

$$\therefore y = 5 \quad \text{or} \quad y = -1$$

Substituting these two y -values into the derivative gives

$$\frac{dy}{dx} = \frac{1}{6} \quad \text{or} \quad \frac{dy}{dx} = -\frac{1}{6}$$

Note: To explain the two answers here, we consider the graph of $x = y^2 - 4y$, which is the reflection of the graph of $y = x^2 - 4x$ in the line with equation $y = x$.

Graph of $y = x^2 - 4x$

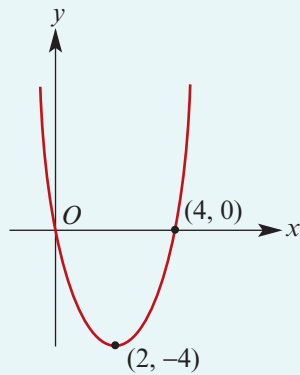

Graph of $x = y^2 - 4y$

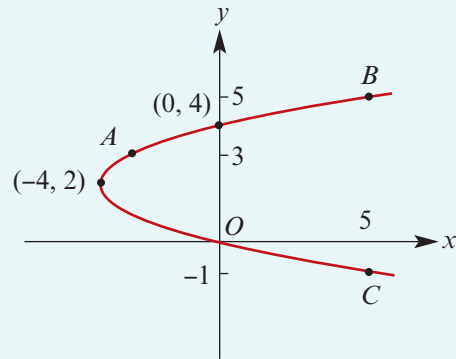

When $x = 5$, there are two points, B and C , on the graph of $x = y^2 - 4y$.

$$\text{At } B, y = 5 \text{ and } \frac{dy}{dx} = \frac{1}{6}.$$

$$\text{At } C, y = -1 \text{ and } \frac{dy}{dx} = -\frac{1}{6}.$$

Using the TI-Nspire

- First solve $x = y^2 - 4y$ for y .
- Differentiate each expression for y with respect to x and then substitute $x = 5$, as shown.

Note: Press $\left[\frac{d}{dx}\right]$ to obtain the derivative template $\frac{d}{dx}\square$.

TI-Nspire calculator screen showing the solution of $x = y^2 - 4y$ for y , resulting in $y = -(\sqrt{x+4} - 2)$ or $y = \sqrt{x+4} + 2$. It then shows the derivative of the first expression with respect to x , resulting in $\frac{d}{dx}(-(\sqrt{x+4} - 2)) = \frac{-1}{2 \cdot \sqrt{x+4}}$, and evaluates it at $x=5$ to get $\frac{-1}{6}$.

TI-Nspire calculator screen showing the derivative of the second expression with respect to x , resulting in $\frac{d}{dx}(\sqrt{x+4} + 2) = \frac{1}{2 \cdot \sqrt{x+4}}$, and evaluates it at $x=5$ to get $\frac{1}{6}$.

Using the Casio ClassPad

- In $\sqrt{\square}$, enter the equation $x = y^2 - 4y$ and solve for y .
- Enter and highlight each expression for y as shown.
- Go to **Interactive** > **Calculation** > **diff**.
- Substitute $x = 5$.

Casio ClassPad calculator screen showing the solution of $x = y^2 - 4y$ for y , resulting in $\{y = -\sqrt{x+4} + 2, y = \sqrt{x+4} + 2\}$. It then shows the derivative of the first expression with respect to x , resulting in $\frac{d}{dx}(-\sqrt{x+4} + 2) = \frac{-1}{2 \cdot \sqrt{x+4}}$, and evaluates it at $x=5$ to get $-\frac{1}{6}$. It also shows the derivative of the second expression with respect to x , resulting in $\frac{d}{dx}(\sqrt{x+4} + 2) = \frac{1}{2 \cdot \sqrt{x+4}}$, and evaluates it at $x=5$ to get $\frac{1}{6}$.

Exercise 10B

Skillsheet

- 1 Using $\frac{dy}{dx} = \frac{1}{\frac{dx}{dy}}$, find $\frac{dy}{dx}$ for each of the following:

Example 5

- | | | | |
|------------------------------|----------------------|---------------------------|----------------------------|
| a $x = 2y + 6$ | b $x = y^2$ | c $x = (2y - 1)^2$ | d $x = e^y$ |
| e $x = \sin(5y)$ | f $x = \ln y$ | g $x = \tan y$ | h $x = y^3 + y - 2$ |
| i $x = \frac{y-1}{y}$ | j $x = ye^y$ | | |

Example 6, 7

2 For each of the following, find the gradient of the curve at the given value:

a $x = y^3$ at $y = \frac{1}{8}$

b $x = y^3$ at $x = \frac{1}{8}$

c $x = e^{4y}$ at $y = 0$

d $x = e^{4y}$ at $x = \frac{1}{4}$

e $x = (1 - 2y)^2$ at $y = 1$

f $x = (1 - 2y)^2$ at $x = 4$

g $x = \cos(2y)$ at $y = \frac{\pi}{6}$

h $x = \cos(2y)$ at $x = 0$

3 For each of the following, express $\frac{dy}{dx}$ in terms of y :

a $x = (2y - 1)^3$

b $x = e^{2y+1}$

c $x = \ln(2y - 1)$

d $x = \ln(2y) - 1$

4 For each relation in Question 3, by first making y the subject, express $\frac{dy}{dx}$ in terms of x .

5 Find the equations of the tangents to the curve with equation $x = 2 - 3y^2$ at the points where $x = -1$.

6 a Find the coordinates of the points of intersection of the graphs of the relations $x = y^2 - 4y$ and $y = x - 6$.

b Find the coordinates of the point at which the tangent to the graph of $x = y^2 - 4y$ is parallel to the line $y = x - 6$.

c Find the coordinates of the point at which the tangent to the graph of $x = y^2 - 4y$ is perpendicular to the line $y = x - 6$.

7 a Show that the graphs of $x = y^2 - y$ and $y = \frac{1}{2}x + 1$ intersect where $x = 2$ and find the coordinates of this point.

b Find, correct to two decimal places, the angle between the line $y = \frac{1}{2}x + 1$ and the tangent to the graph of $x = y^2 - y$ at the point of intersection found in **a** (that is, at the point where $x = 2$).



10C Derivatives of inverse circular functions

The result established in the previous section

$$\frac{dy}{dx} = \frac{1}{\frac{dx}{dy}}$$

can be used to find the derivative of the inverse of a one-to-one function, provided we know the derivative of the original function.

For example, for the function with rule $y = \ln x$, the equivalent function is $x = e^y$. Given that we know $\frac{dx}{dy} = e^y$, we obtain $\frac{dy}{dx} = \frac{1}{e^y}$. But $x = e^y$, and therefore $\frac{dy}{dx} = \frac{1}{x}$.

► The derivative of $\sin^{-1}(x)$

If $f(x) = \sin^{-1}(x)$, then $f'(x) = \frac{1}{\sqrt{1-x^2}}$ for $x \in (-1, 1)$.

Proof Let $y = \sin^{-1}(x)$, where $x \in [-1, 1]$ and $y \in \left[-\frac{\pi}{2}, \frac{\pi}{2}\right]$.

The equivalent form is $x = \sin y$ and so $\frac{dx}{dy} = \cos y$.

Thus $\frac{dy}{dx} = \frac{1}{\cos y}$ and $\cos y \neq 0$ for $y \in \left(-\frac{\pi}{2}, \frac{\pi}{2}\right)$.

The Pythagorean identity is used to express $\frac{dy}{dx}$ in terms of x :

$$\begin{aligned}\sin^2 y + \cos^2 y &= 1 \\ \cos^2 y &= 1 - \sin^2 y \\ \cos y &= \pm\sqrt{1 - \sin^2 y}\end{aligned}$$

Therefore $\cos y = \sqrt{1 - \sin^2 y}$ since $y \in \left(-\frac{\pi}{2}, \frac{\pi}{2}\right)$ and so $\cos y > 0$
 $= \sqrt{1 - x^2}$ since $x = \sin y$

Hence $\frac{dy}{dx} = \frac{1}{\cos y} = \frac{1}{\sqrt{1-x^2}}$ for $x \in (-1, 1)$

► The derivative of $\cos^{-1}(x)$

If $f(x) = \cos^{-1}(x)$, then $f'(x) = \frac{-1}{\sqrt{1-x^2}}$ for $x \in (-1, 1)$.

Proof Let $y = \cos^{-1}(x)$, where $x \in [-1, 1]$ and $y \in [0, \pi]$.

The equivalent form is $x = \cos y$ and so $\frac{dx}{dy} = -\sin y$.

Thus $\frac{dy}{dx} = \frac{-1}{\sin y}$ and $\sin y \neq 0$ for $y \in (0, \pi)$.

Using the Pythagorean identity yields

$$\sin y = \pm\sqrt{1 - \cos^2 y}$$

Therefore $\sin y = \sqrt{1 - \cos^2 y}$ since $y \in (0, \pi)$ and so $\sin y > 0$
 $= \sqrt{1 - x^2}$ since $x = \cos y$

Hence $\frac{dy}{dx} = \frac{-1}{\sin y} = \frac{-1}{\sqrt{1-x^2}}$

► The derivative of $\tan^{-1}(x)$

If $f(x) = \tan^{-1}(x)$, then $f'(x) = \frac{1}{1+x^2}$ for $x \in \mathbb{R}$.

Proof Let $y = \tan^{-1}(x)$, where $x \in \mathbb{R}$ and $y \in \left(-\frac{\pi}{2}, \frac{\pi}{2}\right)$.

Then $x = \tan y$. Therefore $\frac{dx}{dy} = \sec^2 y$, giving $\frac{dy}{dx} = \frac{1}{\sec^2 y}$.

Using the Pythagorean identity $\sec^2 y = 1 + \tan^2 y$, we have

$$\begin{aligned} \frac{dy}{dx} &= \frac{1}{\sec^2 y} = \frac{1}{1 + \tan^2 y} \\ &= \frac{1}{1 + x^2} \quad \text{since } x = \tan y \end{aligned}$$

For $a > 0$, the following results can be obtained using the chain rule.

Inverse circular functions

$$f: (-a, a) \rightarrow \mathbb{R}, \quad f(x) = \sin^{-1}\left(\frac{x}{a}\right), \quad f'(x) = \frac{1}{\sqrt{a^2 - x^2}}$$

$$f: (-a, a) \rightarrow \mathbb{R}, \quad f(x) = \cos^{-1}\left(\frac{x}{a}\right), \quad f'(x) = \frac{-1}{\sqrt{a^2 - x^2}}$$

$$f: \mathbb{R} \rightarrow \mathbb{R}, \quad f(x) = \tan^{-1}\left(\frac{x}{a}\right), \quad f'(x) = \frac{a}{a^2 + x^2}$$

Proof We show how to obtain the first result; the remaining two are left as an exercise.

Let $y = \sin^{-1}\left(\frac{x}{a}\right)$. Then by the chain rule:

$$\frac{dy}{dx} = \frac{1}{\sqrt{1 - \left(\frac{x}{a}\right)^2}} \times \frac{1}{a} = \frac{1}{\sqrt{a^2 \left(1 - \frac{x^2}{a^2}\right)}} = \frac{1}{\sqrt{a^2 - x^2}}$$

Example 8

Differentiate each of the following with respect to x :

a $\sin^{-1}\left(\frac{x}{3}\right)$

b $\cos^{-1}(4x)$

c $\tan^{-1}\left(\frac{2x}{3}\right)$

d $\sin^{-1}(x^2 - 1)$

Solution

a Let $y = \sin^{-1}\left(\frac{x}{3}\right)$. Then

$$\frac{dy}{dx} = \frac{1}{\sqrt{9 - x^2}}$$

b Let $y = \cos^{-1}(4x)$ and $u = 4x$.

By the chain rule:

$$\begin{aligned} \frac{dy}{dx} &= \frac{-1}{\sqrt{1 - u^2}} \times 4 \\ &= \frac{-4}{\sqrt{1 - 16x^2}} \end{aligned}$$

c Let $y = \tan^{-1}\left(\frac{2x}{3}\right)$ and $u = \frac{2x}{3}$.

By the chain rule:

$$\begin{aligned}\frac{dy}{dx} &= \frac{1}{1+u^2} \times \frac{2}{3} \\ &= \frac{1}{1+\left(\frac{2x}{3}\right)^2} \times \frac{2}{3} \\ &= \frac{9}{4x^2+9} \times \frac{2}{3} \\ &= \frac{6}{4x^2+9}\end{aligned}$$

d Let $y = \sin^{-1}(x^2 - 1)$ and $u = x^2 - 1$.

By the chain rule:

$$\begin{aligned}\frac{dy}{dx} &= \frac{1}{\sqrt{1-u^2}} \times 2x \\ &= \frac{2x}{\sqrt{1-(x^2-1)^2}} \\ &= \frac{2x}{\sqrt{1-(x^4-2x^2+1)}} \\ &= \frac{2x}{\sqrt{2x^2-x^4}} \\ &= \frac{2x}{\sqrt{x^2}\sqrt{2-x^2}} \\ &= \frac{2x}{|x|\sqrt{2-x^2}}\end{aligned}$$

Hence $\frac{dy}{dx} = \frac{2}{\sqrt{2-x^2}}$ for $0 < x < \sqrt{2}$

and $\frac{dy}{dx} = \frac{-2}{\sqrt{2-x^2}}$ for $-\sqrt{2} < x < 0$

Exercise 10C

Skillsheet

1 Find the derivative of each of the following with respect to x :

Example 8

a $\sin^{-1}\left(\frac{x}{2}\right)$ **b** $\cos^{-1}\left(\frac{x}{4}\right)$ **c** $\tan^{-1}\left(\frac{x}{3}\right)$ **d** $\sin^{-1}(3x)$ **e** $\cos^{-1}(2x)$

f $\tan^{-1}(5x)$ **g** $\sin^{-1}\left(\frac{3x}{4}\right)$ **h** $\cos^{-1}\left(\frac{3x}{2}\right)$ **i** $\tan^{-1}\left(\frac{2x}{5}\right)$ **j** $\sin^{-1}(0.2x)$

2 Find the derivative of each of the following with respect to x :

a $\sin^{-1}(x+1)$ **b** $\cos^{-1}(2x+1)$ **c** $\tan^{-1}(x+2)$ **d** $\sin^{-1}(4-x)$

e $\cos^{-1}(1-3x)$ **f** $3\tan^{-1}(1-2x)$ **g** $2\sin^{-1}\left(\frac{3x+1}{2}\right)$ **h** $-4\cos^{-1}\left(\frac{5x-3}{2}\right)$

i $5\tan^{-1}\left(\frac{1-x}{2}\right)$ **j** $-\sin^{-1}(x^2)$

3 Find the derivative of each of the following with respect to x :

a $y = \cos^{-1}\left(\frac{3}{x}\right)$ for $x > 3$ **b** $y = \sin^{-1}\left(\frac{5}{x}\right)$ for $x > 5$ **c** $y = \cos^{-1}\left(\frac{3}{2x}\right)$ for $x > \frac{3}{2}$

4 For a positive constant a , find the derivative of each of the following:

a $\sin^{-1}(ax)$ **b** $\cos^{-1}(ax)$ **c** $\tan^{-1}(ax)$

5 Find the second derivative of each of the following:

a $4\sin^{-1}(x)$ **b** $\tan^{-1}(x)$ **c** $3\sin^{-1}\left(\frac{x}{4}\right)$ **d** $\cos^{-1}(3x)$ **e** $2\tan^{-1}\left(\frac{2x}{3}\right)$

- 6** Let $f(x) = 3 \sin^{-1}\left(\frac{x}{2}\right)$.
- a i** Find the maximal domain of f . **ii** Find the range of f .
- b** Find the derivative of $f(x)$, and state the domain for which the derivative exists.
- c** Sketch the graph of $y = f'(x)$, labelling the turning points and the asymptotes.
- 7** Let $f(x) = 4 \cos^{-1}(3x)$.
- a i** Find the maximal domain of f . **ii** Find the range of f .
- b** Find the derivative of $f(x)$, and state the domain for which the derivative exists.
- c** Sketch the graph of $y = f'(x)$, labelling the turning points and the asymptotes.
- 8** Let $f(x) = 2 \tan^{-1}\left(\frac{x+1}{2}\right)$.
- a i** Find the maximal domain of f . **ii** Find the range of f .
- b** Find the derivative of $f(x)$.
- c** Sketch the graph of $y = f'(x)$, labelling the turning points and the asymptotes.
- 9** Differentiate each of the following with respect to x :
- a** $(\sin^{-1} x)^2$ **b** $\sin^{-1} x + \cos^{-1} x$ **c** $\sin(\cos^{-1} x)$
d $\cos(\sin^{-1} x)$ **e** $e^{\sin^{-1} x}$ **f** $\tan^{-1}(e^x)$
- 10** Find, correct to two decimal places where necessary, the gradient of the graph of each of the following functions at the value of x indicated:
- a** $f(x) = \sin^{-1}\left(\frac{x}{3}\right)$, $x = 1$ **b** $f(x) = 2 \cos^{-1}(3x)$, $x = 0.1$
c $f(x) = 3 \tan^{-1}(2x + 1)$, $x = 1$
- 11** For each of the following, find the value(s) of a from the given information:
- a** $f(x) = 2 \sin^{-1} x$, $f'(a) = 4$ **b** $f(x) = 3 \cos^{-1}\left(\frac{x}{2}\right)$, $f'(a) = -10$
c $f(x) = \tan^{-1}(3x)$, $f'(a) = 0.5$ **d** $f(x) = \sin^{-1}\left(\frac{x+1}{2}\right)$, $f'(a) = 20$
e $f(x) = 2 \cos^{-1}\left(\frac{2x}{3}\right)$, $f'(a) = -8$ **f** $f(x) = 4 \tan^{-1}(2x - 1)$, $f'(a) = 1$
- 12** Find, in the form $y = mx + c$, the equation of the tangent to the graph of:
- a** $y = \sin^{-1}(2x)$ at $x = \frac{1}{4}$ **b** $y = \tan^{-1}(2x)$ at $x = \frac{1}{2}$
c $y = \cos^{-1}(3x)$ at $x = \frac{1}{6}$ **d** $y = \cos^{-1}(3x)$ at $x = \frac{1}{2\sqrt{3}}$
- 13** Let $f(x) = \cos^{-1}\left(\frac{6}{x}\right)$.
- a** Find the maximal domain of f .
- b** Find $f'(x)$ and show that $f'(x) > 0$ for $x > 6$.
- c** Sketch the graph of $y = f(x)$ and label endpoints and asymptotes.



10D Related rates

Consider the situation of a right circular cone being filled from a tap.

At time t seconds:

- the volume of water in the cone is $V \text{ cm}^3$
- the height of the water in the cone is $h \text{ cm}$
- the radius of the circular water surface is $r \text{ cm}$.

As the water flows in, the values of V , h and r change:

- $\frac{dV}{dt}$ is the rate of change of volume with respect to time
- $\frac{dh}{dt}$ is the rate of change of height with respect to time
- $\frac{dr}{dt}$ is the rate of change of radius with respect to time.

It is clear that these rates are related to each other. The chain rule is used to establish these relationships.

For example, if the height of the cone is 30 cm and the radius of the cone is 10 cm, then similar triangles yield

$$\frac{r}{h} = \frac{10}{30}$$

$$\therefore h = 3r$$

Then the chain rule is used:

$$\begin{aligned} \frac{dh}{dt} &= \frac{dh}{dr} \cdot \frac{dr}{dt} \\ &= 3 \cdot \frac{dr}{dt} \end{aligned}$$

The volume of a cone is given in general by $V = \frac{1}{3}\pi r^2 h$.

Since $h = 3r$, we have

$$V = \pi r^3$$

Therefore by using the chain rule again:

$$\begin{aligned} \frac{dV}{dt} &= \frac{dV}{dr} \cdot \frac{dr}{dt} \\ &= 3\pi r^2 \cdot \frac{dr}{dt} \end{aligned}$$

The relationships between the rates have been established.

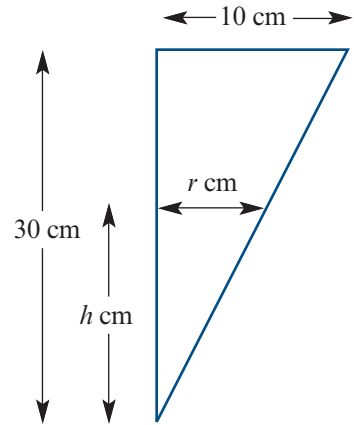
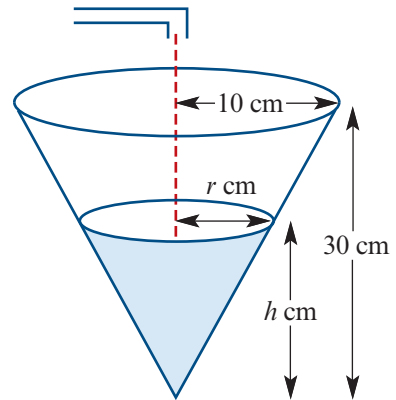

Example 9

A rectangular prism is being filled with water at a rate of $0.00042 \text{ m}^3/\text{s}$. Find the rate at which the height of the water is increasing.

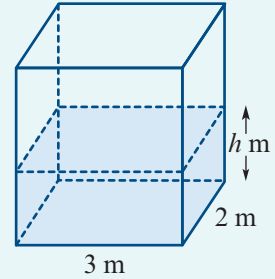
**Solution**

Let t be the time in seconds after the prism begins to fill. Let $V \text{ m}^3$ be the volume of water at time t , and let $h \text{ m}$ be the height of the water at time t .

We are given that $\frac{dV}{dt} = 0.00042$ and $V = 6h$.

Using the chain rule, the rate at which the height is increasing is

$$\frac{dh}{dt} = \frac{dh}{dV} \frac{dV}{dt}$$

Since $V = 6h$, we have $\frac{dV}{dh} = 6$ and so $\frac{dh}{dV} = \frac{1}{6}$.

$$\begin{aligned} \text{Thus } \frac{dh}{dt} &= \frac{1}{6} \times 0.00042 \\ &= 0.00007 \text{ m/s} \end{aligned}$$

i.e. the height is increasing at a rate of 0.00007 m/s .

Example 10

As Steven's ice block melts, it forms a circular puddle on the floor. The radius of the puddle increases at a rate of 3 cm/min . When its radius is 2 cm , find the rate at which the area of the puddle is increasing.

Solution

The area, A , of a circle is given by $A = \pi r^2$, where r is the radius of the circle.

The rate of increase of the radius is $\frac{dr}{dt} = 3 \text{ cm/min}$.

Using the chain rule, the rate of increase of the area is

$$\begin{aligned} \frac{dA}{dt} &= \frac{dA}{dr} \frac{dr}{dt} \\ &= 2\pi r \times 3 \\ &= 6\pi r \end{aligned}$$

$$\text{When } r = 2, \frac{dA}{dt} = 12\pi.$$

Hence the area of the puddle is increasing at $12\pi \text{ cm}^2/\text{min}$.

Example 11

A metal cube is being heated so that the side length is increasing at the rate of 0.02 cm per hour. Calculate the rate at which the volume is increasing when the side length is 5 cm.

Solution

Let x be the length of a side of the cube. Then the volume is $V = x^3$.

We are given that $\frac{dx}{dt} = 0.02$ cm/h.

The rate of increase of volume is found using the chain rule:

$$\begin{aligned}\frac{dV}{dt} &= \frac{dV}{dx} \frac{dx}{dt} \\ &= 3x^2 \times 0.02 \\ &= 0.06x^2\end{aligned}$$

When $x = 5$, the volume of the cube is increasing at a rate of $1.5 \text{ cm}^3/\text{h}$.

**Example 12**

The diagram shows a rectangular block of ice that is x cm by x cm by $5x$ cm.

- a** Express the total surface area, $A \text{ cm}^2$, in terms of x and then find $\frac{dA}{dx}$.
- b** If the ice is melting such that the total surface area is decreasing at a constant rate of $4 \text{ cm}^2/\text{s}$, calculate the rate of decrease of x when $x = 2$.

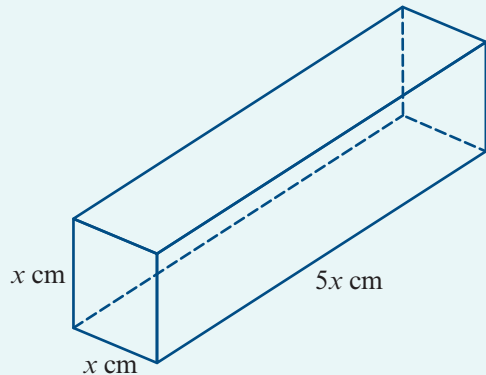
**Solution**

a $A = 4 \times 5x^2 + 2 \times x^2$
 $= 22x^2$

$$\frac{dA}{dx} = 44x$$

b The surface area is decreasing, so $\frac{dA}{dt} = -4$.

By the chain rule:

$$\begin{aligned}\frac{dx}{dt} &= \frac{dx}{dA} \frac{dA}{dt} \\ &= \frac{1}{44x} \times (-4) \\ &= -\frac{1}{11x}\end{aligned}$$

When $x = 2$, $\frac{dx}{dt} = -\frac{1}{22} \text{ cm/s}$.

Note: The rates of change of the lengths of the edges are $-\frac{1}{22} \text{ cm/s}$, $-\frac{1}{22} \text{ cm/s}$ and $-\frac{5}{22} \text{ cm/s}$. The negative signs indicate that the lengths are decreasing.

► Parametric equations

Parametric equations were introduced in Chapter 1. For example:

- The unit circle can be described by the parametric equations $x = \cos t$ and $y = \sin t$.
- The parabola $y^2 = 4ax$ can be described by the parametric equations $x = at^2$ and $y = 2at$.

In general, a parametric curve is specified by a pair of equations

$$x = f(t) \quad \text{and} \quad y = g(t)$$

For a point $(f(t), g(t))$ on the curve, we can consider the gradient of the tangent to the curve at this point. By the chain rule, we have

$$\frac{dy}{dt} = \frac{dy}{dx} \frac{dx}{dt}$$

This gives the following result.

Gradient at a point on a parametric curve

$$\frac{dy}{dx} = \frac{\frac{dy}{dt}}{\frac{dx}{dt}} \quad \text{provided} \quad \frac{dx}{dt} \neq 0$$

Note: A curve defined by parametric equations is not necessarily the graph of a function. However, each value of t determines a point on the curve, and we can use this technique to find the gradient of the curve at this point (given the tangent exists).

Example 13

A curve has parametric equations

$$x = 2t - \ln(2t) \quad \text{and} \quad y = t^2 - \ln(t^2)$$

Find:

a $\frac{dy}{dt}$ and $\frac{dx}{dt}$

b $\frac{dy}{dx}$

Solution

a $x = 2t - \ln(2t)$

$$\begin{aligned} \therefore \frac{dx}{dt} &= 2 - \frac{1}{t} \\ &= \frac{2t - 1}{t} \end{aligned}$$

$$y = t^2 - \ln(t^2)$$

$$\begin{aligned} \therefore \frac{dy}{dt} &= 2t - \frac{2}{t} \\ &= \frac{2t^2 - 2}{t} \end{aligned}$$

b $\frac{dy}{dx} = \frac{\frac{dy}{dt}}{\frac{dx}{dt}}$

$$\begin{aligned} &= \frac{2t^2 - 2}{t} \times \frac{t}{2t - 1} \\ &= \frac{2t^2 - 2}{2t - 1} \end{aligned}$$



Example 14

For the curve defined by the given parametric equations, find the gradient of the tangent at a point $P(x, y)$ on the curve, in terms of the parameter t :

a $x = 16t^2$ and $y = 32t$

b $x = 2 \sin(3t)$ and $y = -2 \cos(3t)$

Solution

a $x = 16t^2$ and so $\frac{dx}{dt} = 32t$

$y = 32t$ and so $\frac{dy}{dt} = 32$

Therefore

$$\frac{dy}{dx} = \frac{\frac{dy}{dt}}{\frac{dx}{dt}} = \frac{32}{32t} = \frac{1}{t}$$

The gradient of the tangent at the point $P(16t^2, 32t)$ is $\frac{1}{t}$, for $t \neq 0$.

b $x = 2 \sin(3t)$ and so $\frac{dx}{dt} = 6 \cos(3t)$

$y = -2 \cos(3t)$ and so $\frac{dy}{dt} = 6 \sin(3t)$

Therefore

$$\frac{dy}{dx} = \frac{\frac{dy}{dt}}{\frac{dx}{dt}} = \frac{6 \sin(3t)}{6 \cos(3t)} = \tan(3t)$$

The gradient of the tangent at the point $P(2 \sin(3t), -2 \cos(3t))$ is $\tan(3t)$.

The second derivative at a point on a parametric curve

If the parametric equations for a curve define a function for which the second derivative exists, then $\frac{d^2y}{dx^2}$ can be found as follows:

$$\frac{d^2y}{dx^2} = \frac{d(y')}{dx} = \frac{\frac{dy'}{dt}}{\frac{dx}{dt}} \quad \text{where } y' = \frac{dy}{dx}$$

Example 15

A curve is defined by the parametric equations $x = t - t^3$ and $y = t - t^2$. Find $\frac{d^2y}{dx^2}$.

Solution

Let $y' = \frac{dy}{dx}$. Then $y' = \frac{dy}{dt} \div \frac{dx}{dt}$.

We have $x = t - t^3$ and $y = t - t^2$, giving $\frac{dx}{dt} = 1 - 3t^2$ and $\frac{dy}{dt} = 1 - 2t$.

Therefore

$$y' = \frac{1 - 2t}{1 - 3t^2}$$

Next differentiate y' with respect to t , using the quotient rule:

$$\frac{dy'}{dt} = \frac{-2(3t^2 - 3t + 1)}{(3t^2 - 1)^2}$$

Hence

$$\begin{aligned}\frac{d^2y}{dx^2} &= \frac{dy'}{dt} \div \frac{dx}{dt} \\ &= \frac{-2(3t^2 - 3t + 1)}{(3t^2 - 1)^2} \times \frac{1}{1 - 3t^2} \\ &= \frac{-2(3t^2 - 3t + 1)}{(1 - 3t^2)^3} \\ &= \frac{-6t^2 + 6t - 2}{(1 - 3t^2)^3}\end{aligned}$$

Exercise 10D**Example 9, 10**

- 1** The radius of a spherical balloon is 2.5 m and its volume is increasing at a rate of $0.1 \text{ m}^3/\text{min}$.
- At what rate is the radius increasing?
 - At what rate is the surface area increasing?

Example 11

- 2** When a wine glass is filled to a depth of $x \text{ cm}$, it contains $V \text{ cm}^3$ of wine, where $V = 4x^{\frac{3}{2}}$. If the depth is 9 cm and wine is being poured into the glass at $10 \text{ cm}^3/\text{s}$, at what rate is the depth changing?
- 3** Variables x and y are connected by the equation $y = 2x^2 + 5x + 2$. Given that x is increasing at the rate of 3 units per second, find the rate of increase of y with respect to time when $x = 2$.

Example 12

- 4** If a hemispherical bowl of radius 6 cm contains water to a depth of $x \text{ cm}$, the volume, $V \text{ cm}^3$, of the water is given by

$$V = \frac{1}{3}\pi x^2(18 - x)$$

Water is poured into the bowl at a rate of $3 \text{ cm}^3/\text{s}$. Find the rate at which the water level is rising when the depth is 2 cm .

- 5** Variables p and v are linked by the equation $pv = 1500$. Given that p is increasing at the rate of 2 units per minute, find the rate of decrease of v at the instant when $p = 60$.
- 6** A circular metal disc is being heated so that the radius is increasing at the rate of 0.01 cm per hour. Find the rate at which the area is increasing when the radius is 4 cm .
- 7** The area of a circle is increasing at the rate of 4 cm^2 per second. At what rate is the circumference increasing at the instant when the radius is 8 cm ?

Example 13

8 A curve has parametric equations $x = \frac{1}{1+t^2}$ and $y = \frac{t}{1+t^2}$.

a Find $\frac{dy}{dt}$ and $\frac{dx}{dt}$.

b Find $\frac{dy}{dx}$.

9 A curve has parametric equations $x = 2t + \sin(2t)$ and $y = \cos(2t)$. Find $\frac{dy}{dx}$.

Example 14

10 A curve has parametric equations $x = t - \cos t$ and $y = \sin t$. Find the equation of the tangent to the curve when $t = \frac{\pi}{6}$.

11 A point moves along the curve $y = x^2$ such that its velocity parallel to the x -axis is a constant 2 cm/s (i.e. $\frac{dx}{dt} = 2$). Find its velocity parallel to the y -axis (i.e. $\frac{dy}{dt}$) when:

a $x = 3$

b $y = 16$

12 Variables x and y are related by $y = \frac{2x-6}{x}$. They are given by $x = f(t)$ and $y = g(t)$, where f and g are functions of time. Find $f'(t)$ when $y = 1$, given that $g'(t) = 0.4$.

13 A particle moves along the curve

$$y = 10 \cos^{-1}\left(\frac{x-5}{5}\right)$$

in such a way that its velocity parallel to the x -axis is a constant 3 cm/s. Find its velocity parallel to the y -axis when:

a $x = 6$

b $y = \frac{10\pi}{3}$

14 The radius, r cm, of a sphere is increasing at a constant rate of 2 cm/s. Find, in terms of π , the rate at which the volume is increasing at the instant when the volume is 36π cm³.

15 Liquid is poured into a container at a rate of 12 cm³/s. The volume of liquid in the container is V cm³, where $V = \frac{1}{2}(h^2 + 4h)$ and h is the height of the liquid in the container. Find, when $V = 16$:

a the value of h

b the rate at which h is increasing

16 The area of an ink blot, which is always circular in shape, is increasing at a rate of 3.5 cm²/s. Find the rate of increase of the radius when the radius is 3 cm.

17 A tank in the shape of a prism has constant cross-sectional area A cm². The amount of water in the tank at time t seconds is V cm³ and the height of the water is h cm. Find the relationship between $\frac{dV}{dt}$ and $\frac{dh}{dt}$.

- 18** A cylindrical tank 5 m high with base radius 2 m is initially full of water. Water flows out through a hole at the bottom of the tank at the rate of \sqrt{h} m³/h, where h metres is the depth of the water remaining in the tank after t hours. Find:

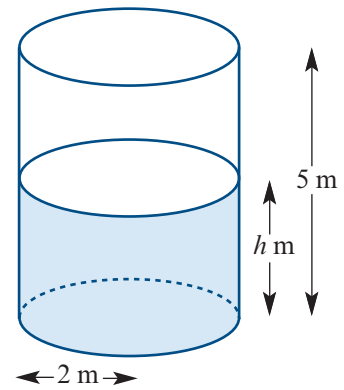

- a** $\frac{dh}{dt}$
- b i** $\frac{dV}{dt}$ when $V = 10\pi$ m³
- ii** $\frac{dh}{dt}$ when $V = 10\pi$ m³
- 19** For the curve defined by the parametric equations $x = 2 \cos t$ and $y = \sin t$, find the equation of the tangent to the curve at the point:
- a** $(\sqrt{2}, \frac{\sqrt{2}}{2})$ **b** $(2 \cos t, \sin t)$, where t is any real number.
- 20** For the curve defined by the parametric equations $x = 2 \sec \theta$ and $y = \tan \theta$, find the equation of:
- a** the tangent at the point where $\theta = \frac{\pi}{4}$ **b** the normal at the point where $\theta = \frac{\pi}{4}$
- c** the tangent at the point $(2 \sec \theta, \tan \theta)$.
- 21** For the curve with parametric equations $x = 2 \sec t - 3$ and $y = 4 \tan t + 2$, find:
- a** $\frac{dy}{dx}$ **b** the equation of the tangent to the curve when $t = \frac{\pi}{4}$.
- 22** A curve is defined by the parametric equations $x = \sec t$ and $y = \tan t$.
- a** Find the equation of the normal to the curve at the point $(\sec t, \tan t)$.
- b** Let A and B be the points of intersection of the normal to the curve with the x -axis and y -axis respectively, and let O be the origin. Find the area of $\triangle OAB$.
- c** Find the value of t for which the area of $\triangle OAB$ is $4\sqrt{3}$.
- 23** A curve is specified by the parametric equations $x = e^{2t} + 1$ and $y = 2e^t + 1$ for $t \in \mathbb{R}$.
- a** Find the gradient of the curve at the point $(e^{2t} + 1, 2e^t + 1)$.
- b** State the domain of the relation.
- c** Sketch the graph of the relation.
- d** Find the equation of the tangent at the point where $t = \ln\left(\frac{1}{2}\right)$.

Example 15 **24** For the parametric curve given by $x = t^2 + 1$ and $y = t(t - 3)^2$, for $t \in \mathbb{R}$, find:

- a** $\frac{dy}{dx}$ **b** the coordinates of the stationary points
- c** $\frac{d^2y}{dx^2}$ **d** the coordinates of the points of inflection.



10E Rational functions

A rational function has a rule of the form

$$f(x) = \frac{P(x)}{Q(x)}$$

where $P(x)$ and $Q(x)$ are polynomials. There is a huge variety of different types of curves in this particular family of functions. An example of a rational function is

$$f(x) = \frac{x^2 + 2x + 3}{x^2 + 4x - 1}$$

The following are also rational functions, but are not given in the form used in the definition of a rational function:

$$g(x) = 1 + \frac{1}{x} \qquad h(x) = x - \frac{1}{x^2 + 2}$$

Their rules can be rewritten as shown:

$$g(x) = \frac{x}{x} + \frac{1}{x} = \frac{x+1}{x} \qquad h(x) = \frac{x(x^2+2)}{x^2+2} - \frac{1}{x^2+2} = \frac{x^3+2x-1}{x^2+2}$$

► Graphing rational functions

For sketching graphs, it is also useful to write rational functions in the alternative form, that is, with a division performed if possible. For example:

$$f(x) = \frac{8x^2 - 3x + 2}{x} = \frac{8x^2}{x} - \frac{3x}{x} + \frac{2}{x} = 8x - 3 + \frac{2}{x}$$

For this example, we can see that $\frac{2}{x} \rightarrow 0$ as $x \rightarrow \pm\infty$, so the graph of $y = f(x)$ will approach the line $y = 8x - 3$ as $x \rightarrow \pm\infty$.

We say that the line $y = 8x - 3$ is a **non-vertical asymptote** of the graph. This is a line or curve which the graph approaches as $x \rightarrow \pm\infty$.

Important features of a sketch graph are:

- asymptotes
- axis intercepts
- stationary points
- points of inflection.

Methods for sketching graphs of rational functions include:

- adding the y -coordinates (ordinates) of two simple graphs
- taking the reciprocals of the y -coordinates (ordinates) of a simple graph.

► Addition of ordinates

Key points for addition of ordinates

- When the two graphs have the same ordinate, the y -coordinate of the resultant graph will be double this.
- When the two graphs have opposite ordinates, the y -coordinate of the resultant graph will be zero (an x -axis intercept).
- When one of the two ordinates is zero, the resulting ordinate is equal to the other ordinate.

Example 16

Sketch the graph of $f: \mathbb{R} \setminus \{0\} \rightarrow \mathbb{R}$, $f(x) = \frac{x^2 + 1}{x}$.

Solution

Asymptotes The vertical asymptote has equation $x = 0$, i.e. the y -axis.

Dividing through gives

$$f(x) = \frac{x^2 + 1}{x} = \frac{x^2}{x} + \frac{1}{x} = x + \frac{1}{x}$$

Note that $\frac{1}{x} \rightarrow 0$ as $x \rightarrow \pm\infty$. Therefore the graph of $y = f(x)$ approaches the graph of $y = x$ as $x \rightarrow \pm\infty$. The non-vertical asymptote has equation $y = x$.

Addition of ordinates The graph of $y = f(x)$ can be obtained by adding the y -coordinates of the graphs of $y = x$ and $y = \frac{1}{x}$.

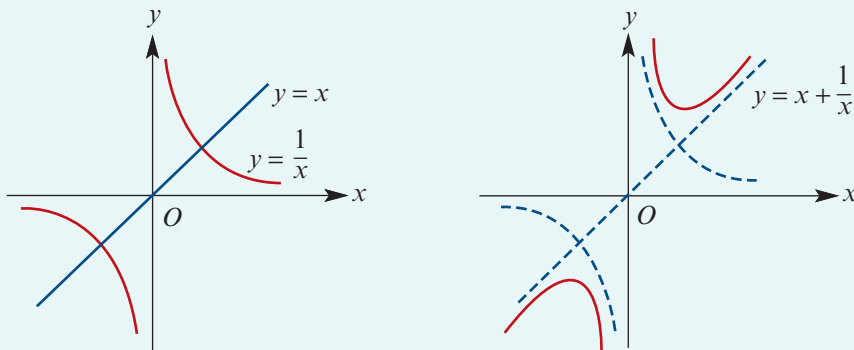

Intercepts There is no y -axis intercept, as the domain of f is $\mathbb{R} \setminus \{0\}$. There are no x -axis intercepts, as the equation $\frac{x^2 + 1}{x} = 0$ has no solutions.

Stationary points

$$f(x) = x + \frac{1}{x}$$

$$\therefore f'(x) = 1 - \frac{1}{x^2}$$

Thus $f'(x) = 0$ implies $x^2 = 1$,
i.e. $x = \pm 1$.

As $f(1) = 2$ and $f(-1) = -2$,
the stationary points are $(1, 2)$
and $(-1, -2)$.

Points of inflection

$$f''(x) = \frac{2}{x^3}$$

Therefore $f''(x) \neq 0$, for all x in the domain of f , and so there are no points of inflection.

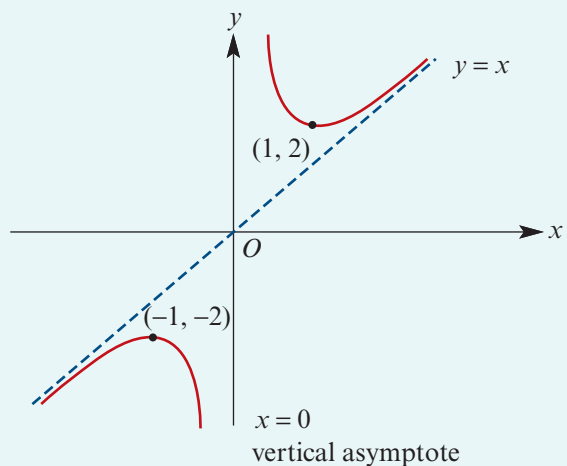

Example 17

Sketch the graph of $f: \mathbb{R} \setminus \{0\} \rightarrow \mathbb{R}, f(x) = \frac{x^4 + 2}{x^2}$.

Solution

Asymptotes The vertical asymptote has equation $x = 0$.

Dividing through gives

$$f(x) = x^2 + \frac{2}{x^2}$$

The non-vertical asymptote has equation $y = x^2$.

Addition of ordinates

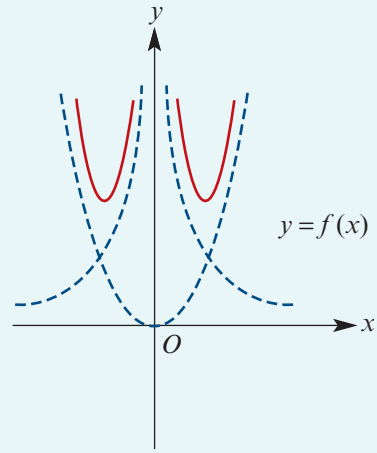
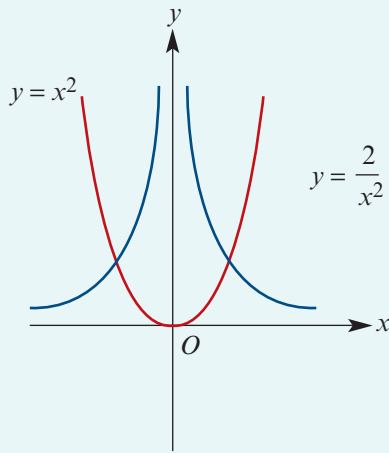

Intercepts There are no axis intercepts.

Stationary points

$$f(x) = x^2 + 2x^{-2}$$

$$\therefore f'(x) = 2x - 4x^{-3}$$

When $f'(x) = 0$,

$$2x - \frac{4}{x^3} = 0$$

$$2x^4 - 4 = 0$$

$$\therefore x = \pm 2^{\frac{1}{4}}$$

The stationary points have coordinates $(2^{\frac{1}{4}}, 2\sqrt{2})$ and $(-2^{\frac{1}{4}}, 2\sqrt{2})$.

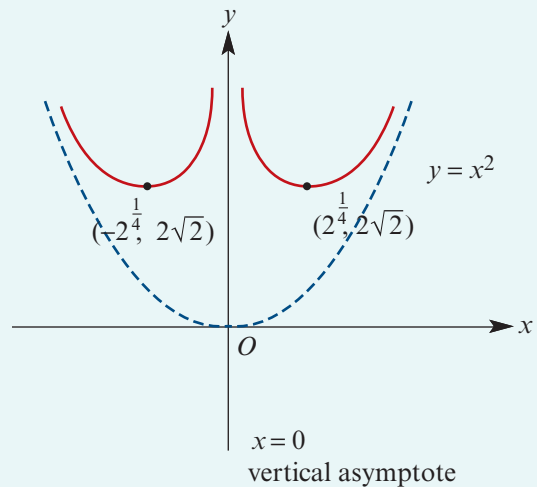

Points of inflection

Since $f''(x) = 2 + 12x^{-4} > 0$, there are no points of inflection.

Example 18

Sketch the graph of $y = \frac{x^3 + 2}{x}$, $x \neq 0$.

Solution

Asymptotes The vertical asymptote has equation $x = 0$.

Divide through to obtain

$$y = x^2 + \frac{2}{x}$$

The non-vertical asymptote has equation $y = x^2$.

Addition of ordinates

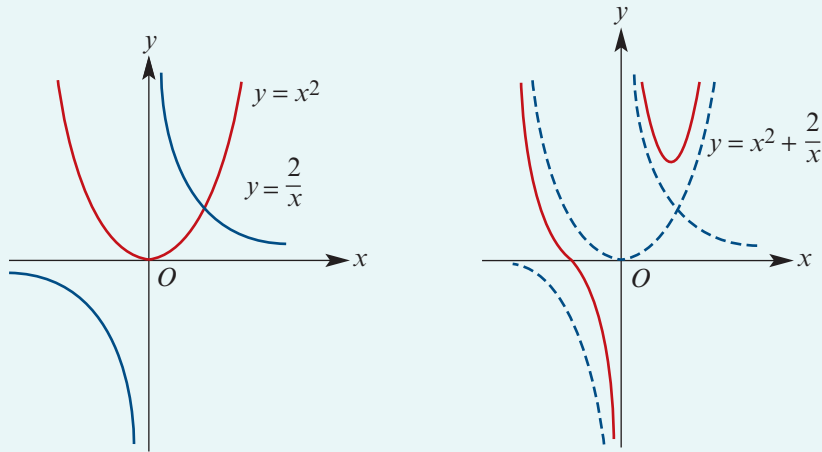

Intercepts Consider $y = 0$, which implies $x^3 + 2 = 0$, i.e. $x = -\sqrt[3]{2}$.

Stationary points

$$y = x^2 + 2x^{-1}$$

$$\therefore \frac{dy}{dx} = 2x - 2x^{-2}$$

$$\text{Thus } \frac{dy}{dx} = 0 \text{ implies } x - \frac{1}{x^2} = 0$$

$$x^3 = 1$$

$$\therefore x = 1$$

The turning point has coordinates $(1, 3)$.

Points of inflection

$$\frac{d^2y}{dx^2} = 2 + 4x^{-3}$$

Thus $\frac{d^2y}{dx^2} = 0$ implies $x = -\sqrt[3]{2}$. There is a point of inflection at $(-\sqrt[3]{2}, 0)$.

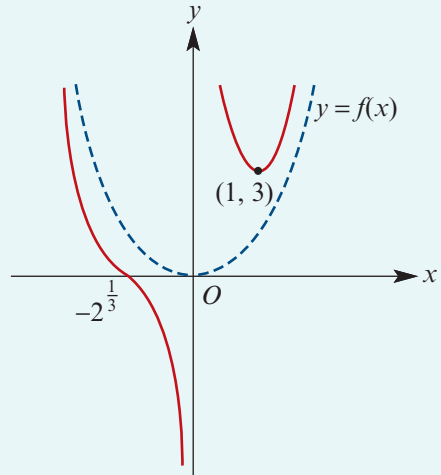

► Reciprocal of ordinates

This is the second method for sketching graphs of rational functions. We will consider functions of the form $f(x) = \frac{1}{Q(x)}$, where $Q(x)$ is a quadratic function.

Example 19

Sketch the graph of $f: \mathbb{R} \setminus \{0, 4\} \rightarrow \mathbb{R}$, $f(x) = \frac{1}{x^2 - 4x}$.

Solution

$$f(x) = \frac{1}{x^2 - 4x} = \frac{1}{x(x - 4)}$$

Asymptotes The vertical asymptotes have equations $x = 0$ and $x = 4$. The non-vertical asymptote has equation $y = 0$, since $f(x) \rightarrow 0$ as $x \rightarrow \pm\infty$.

Reciprocal of ordinates To sketch the graph of $y = f(x)$, first sketch the graph of $y = Q(x)$. In this case, we have $Q(x) = x^2 - 4x$.

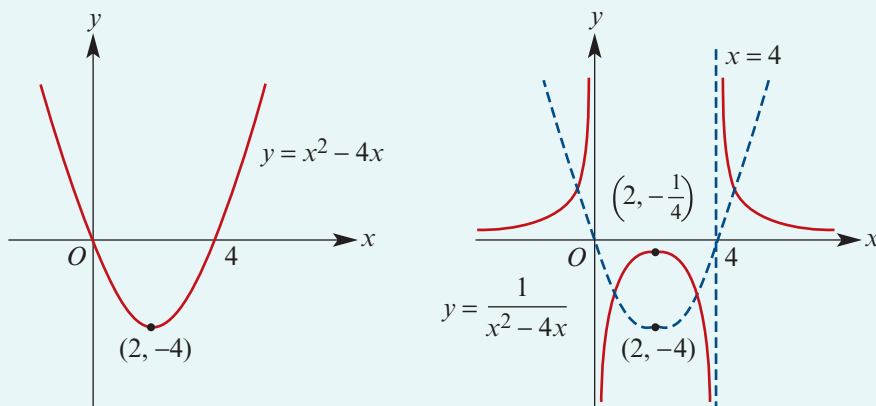

Summary of properties of reciprocal functions

- The x -axis intercepts of the original function determine the equations of the asymptotes for the reciprocal function.
- The reciprocal of a positive number is positive.
- The reciprocal of a negative number is negative.
- A graph and its reciprocal will intersect at a point if the y -coordinate is 1 or -1 .
- Local maximums of the original function produce local minimums of the reciprocal.
- Local minimums of the original function produce local maximums of the reciprocal.
- If $g(x) = \frac{1}{f(x)}$, then $g'(x) = -\frac{f'(x)}{(f(x))^2}$. Therefore, at any given point, the gradient of the reciprocal function is opposite in sign to that of the original function.

► Further graphing

So far we have only started to consider the diversity of rational functions. Here we look at some further rational functions and employ a variety of techniques.

Example 20

Sketch the graph of $y = \frac{4x^2 + 2}{x^2 + 1}$.

Solution

Axis intercepts

When $x = 0$, $y = 2$.

Since $\frac{4x^2 + 2}{x^2 + 1} > 0$ for all x , there are no x -axis intercepts.

Stationary points

Using the quotient rule:

$$\frac{dy}{dx} = \frac{4x}{(x^2 + 1)^2}$$

$$\frac{d^2y}{dx^2} = \frac{4(1 - 3x^2)}{(x^2 + 1)^3}$$

Thus $\frac{dy}{dx} = 0$ implies $x = 0$.

When $x = 0$, $\frac{d^2y}{dx^2} = 4 > 0$. Hence there is a local minimum at $(0, 2)$.

Points of inflection $\frac{d^2y}{dx^2} = 0$ implies $x = \pm \frac{\sqrt{3}}{3}$

Asymptotes

$$y = \frac{4x^2 + 2}{x^2 + 1} = 4 - \frac{2}{x^2 + 1}$$

The line $y = 4$ is a horizontal asymptote, since $\frac{2}{x^2 + 1} \rightarrow 0$ as $x \rightarrow \pm\infty$.

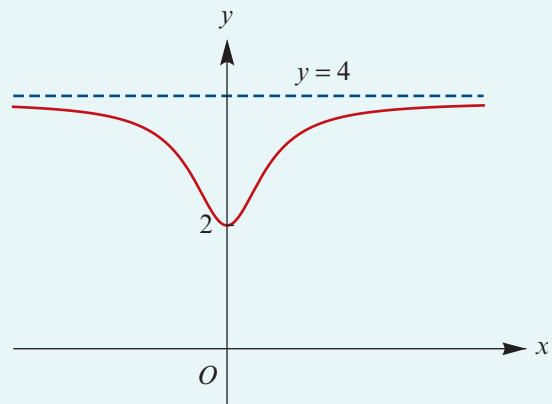



Example 21

Sketch the graph of $y = \frac{4x^2 - 4x + 1}{x^2 - 1}$.

Solution

Axis intercepts

When $x = 0$, $y = -1$.

When $y = 0$, $4x^2 - 4x + 1 = 0$

$$(2x - 1)^2 = 0$$

$$\therefore x = \frac{1}{2}$$

Stationary points

Using the quotient rule:

$$\frac{dy}{dx} = \frac{2(2x^2 - 5x + 2)}{(x^2 - 1)^2}$$

Thus $\frac{dy}{dx} = 0$ implies $x = \frac{1}{2}$ or $x = 2$.

There is a local maximum at $(\frac{1}{2}, 0)$ and a local minimum at $(2, 3)$.

The nature of the stationary points can most easily be determined through using

$$\frac{dy}{dx} = \frac{2(2x - 1)(x - 2)}{(x^2 - 1)^2}. \text{ (Observe that the denominator is always positive.)}$$

Points of inflection

$$\frac{d^2y}{dx^2} = -\frac{2(4x^3 - 15x^2 + 12x - 5)}{(x^2 - 1)^3}$$

Thus $\frac{d^2y}{dx^2} = 0$ implies $4x^3 - 15x^2 + 12x - 5 = 0$, and so $x = \frac{1}{4}(5 + 3^{\frac{4}{3}} + 3^{\frac{2}{3}}) \approx 2.85171$

Asymptotes

By solving $x^2 - 1 = 0$, we find that the graph has vertical asymptotes $x = 1$ and $x = -1$.

Since $\frac{4x^2 - 4x + 1}{x^2 - 1} = 4 - \frac{4x - 5}{x^2 - 1}$, there is a horizontal asymptote $y = 4$.

The graph crosses this asymptote at the point $(\frac{5}{4}, 4)$.

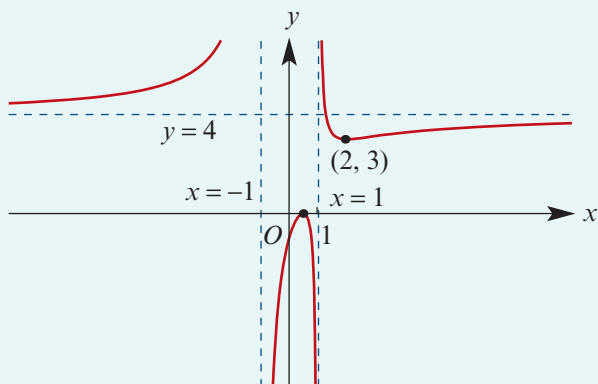

While the next example is not a rational function, it can be graphed using similar techniques.

Example 22

Let $y = \frac{x+1}{\sqrt{x-1}}$.

- Find the maximal domain.
- Find the coordinates and the nature of any stationary points of the graph.
- Find the equation of the vertical asymptote and the behaviour of the graph as $x \rightarrow \infty$.
- Sketch the graph.

Solution

- a** For $\frac{x+1}{\sqrt{x-1}}$ to be defined, we require $\sqrt{x-1} > 0$, i.e. $x > 1$.

The maximal domain is $(1, \infty)$.

- b** Using the quotient and chain rules: $\frac{dy}{dx} = \frac{x-3}{2(x-1)^{\frac{3}{2}}}$ and $\frac{d^2y}{dx^2} = \frac{7-x}{4(x-1)^{\frac{5}{2}}}$

Thus $\frac{dy}{dx} = 0$ implies $x = 3$. When $x = 3$, $\frac{d^2y}{dx^2} > 0$.

There is a local minimum at $(3, 2\sqrt{2})$.

- c** As $x \rightarrow 1$, $y \rightarrow \infty$. Hence $x = 1$ is a vertical asymptote.

As $x \rightarrow \infty$, $y \rightarrow \frac{x}{\sqrt{x}} = \sqrt{x}$.

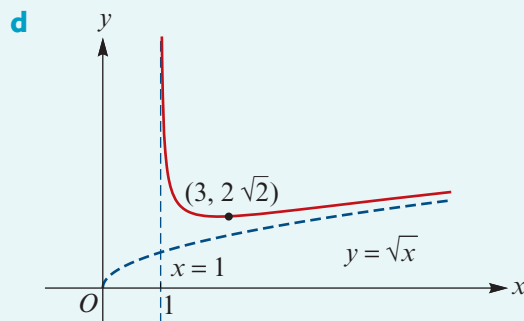

Exercise 10E

Skillsheet

Example 16–19

- 1** Sketch the graph of each of the following, labelling all axis intercepts, turning points and asymptotes:

a $y = \frac{1}{x^2 - 2x}$

b $y = \frac{x^4 + 1}{x^2}$

c $y = \frac{1}{(x-1)^2 + 1}$

d $y = \frac{x^2 - 1}{x}$

e $y = \frac{x^3 - 1}{x^2}$

f $y = \frac{x^2 + x + 1}{x}$

g $y = \frac{4x^3 - 8}{x}$

h $y = \frac{1}{x^2 + 1}$

i $y = \frac{1}{x^2 - 1}$

j $y = \frac{x^2}{x^2 + 1} = 1 - \frac{1}{x^2 + 1}$

k $y = \frac{1}{x^2 - x - 2}$

l $y = \frac{1}{4 + 3x - x^2}$

- 2** Sketch the graph of each of the following, labelling all axis intercepts, turning points and asymptotes:

a $f(x) = \frac{1}{9 - x^2}$ **b** $g(x) = \frac{1}{(x - 2)(3 - x)}$ **c** $h(x) = \frac{1}{x^2 + 2x + 4}$

d $f(x) = \frac{1}{x^2 + 2x + 1}$ **e** $g(x) = x^2 + \frac{1}{x^2} + 2$

- 3** The equation of a curve is $y = 4x + \frac{1}{x}$. Find:

- a** the coordinates of the turning points
b the equation of the tangent to the curve at the point where $x = 2$.

- 4** Find the x -coordinates of the points on the curve $y = \frac{x^2 - 1}{x}$ at which the gradient is 5.

- 5** Find the gradient of the curve $y = \frac{2x - 4}{x^2}$ at the point where it crosses the x -axis.

- 6** Sketch the curve $y = x - 5 + \frac{4}{x}$ by first finding the:

- a** axis intercepts **b** equations of asymptotes **c** coordinates of turning points.

- 7** If x is positive, find the least value of $x + \frac{4}{x^2}$.

- 8** For positive values of x , sketch the graph of $y = x + \frac{4}{x}$, and find the least value of y .

- 9 a** Find the coordinates of the stationary points of the curve $y = \frac{(x - 3)^2}{x}$ and determine the nature of each stationary point.

- b** Sketch the graph of $y = \frac{(x - 3)^2}{x}$.

- 10 a** Find the coordinates and nature of each turning point on the curve $y = 8x + \frac{1}{2x^2}$.

- b** Sketch the graph of $y = 8x + \frac{1}{2x^2}$.

- 11** Determine the asymptotes, intercepts and stationary points for the graph of the relation $y = \frac{x^3 + 3x^2 - 4}{x^2}$. Hence sketch the graph.

- 12** Consider the relation $y = \frac{4x^2 + 8}{2x + 1}$.

- a** State the maximal domain. **b** Find $\frac{dy}{dx}$.

- c** Hence find the coordinates and nature of all stationary points.

- d** Find the equations of all asymptotes. **e** State the range of this relation.

Example 20

- 13** Consider the function with rule $f(x) = \frac{x^2 + 4}{x^2 - 5x + 4}$.

- a** Find the equations of all asymptotes.

- b** Find the coordinates and nature of all stationary points.

- c** Sketch the graph of $y = f(x)$. Include the coordinates of the points of intersection of the graph with the horizontal asymptote.

Example 21 14 Let $y = \frac{2x^2 + 2x + 3}{2x^2 - 2x + 5}$.

- a Find the equations of all asymptotes.
- b Find the coordinates and nature of all stationary points.
- c Find the coordinates of all points of inflection.
- d Sketch the graph of the relation, noting where the graph crosses any asymptotes.

- 15 Sketch the graph of each of the following, labelling all axis intercepts, turning points and asymptotes:

a $y = \frac{x^3 - 3x}{(x - 1)^2}$

b $y = \frac{(x + 1)(x - 3)}{x^2 - 4}$

c $y = \frac{(x - 2)(x + 1)}{x(x - 1)}$

d $y = \frac{x^2 - 2x - 8}{x^2 - 2x}$

e $y = \frac{8x^2 + 7}{4x^2 - 4x - 3}$

Example 22 16 Consider the function with rule $f(x) = \frac{x}{\sqrt{x - 2}}$.

- a Find the maximal domain.
- b Find $f'(x)$.
- c Hence find the coordinates and nature of all stationary points.
- d Find the equation of the vertical asymptote.
- e Find the equation of the other asymptote.

17 Consider the function with rule $f(x) = \frac{x^2 + x + 7}{\sqrt{2x + 1}}$.

- a Find the maximal domain.
- b Find $f(0)$.
- c Find $f'(x)$.
- d Hence find the coordinates and nature of all stationary points.
- e Find the equation of the vertical asymptote.



10F Implicit differentiation

The rules for circles, ellipses and many other curves are not expressible in the form $y = f(x)$ or $x = f(y)$. Equations such as

$$x^2 + y^2 = 1 \quad \text{and} \quad \frac{x^2}{9} + \frac{(y - 3)^2}{4} = 1$$

are said to be implicit equations. In this section, we introduce a technique for finding $\frac{dy}{dx}$ for such relations. The technique is called **implicit differentiation**.

If two algebraic expressions are always equal, then the value of each expression must change in an identical way as one of the variables changes.

That is, if p and q are expressions in x and y such that $p = q$, for all x and y , then

$$\frac{dp}{dx} = \frac{dq}{dx} \quad \text{and} \quad \frac{dp}{dy} = \frac{dq}{dy}$$

For example, consider the relation $x = y^3$. In Example 5, we found that $\frac{dy}{dx} = \frac{1}{3y^2}$.

We can also use implicit differentiation to obtain this result. Differentiate each side of the equation $x = y^3$ with respect to x :

$$\frac{d}{dx}(x) = \frac{d}{dx}(y^3) \quad (1)$$

To simplify the right-hand side using the chain rule, we let $u = y^3$. Then

$$\frac{d}{dx}(y^3) = \frac{du}{dx} = \frac{du}{dy} \times \frac{dy}{dx} = 3y^2 \times \frac{dy}{dx}$$

Hence equation (1) becomes

$$1 = 3y^2 \times \frac{dy}{dx}$$

$$\therefore \frac{dy}{dx} = \frac{1}{3y^2} \quad \text{provided } y \neq 0$$

Example 23

For each of the following, find $\frac{dy}{dx}$ by implicit differentiation:

a $x^3 = y^2$

b $xy = 2x + 1$

Solution

a Differentiate both sides with respect to x :

$$\frac{d}{dx}(x^3) = \frac{d}{dx}(y^2)$$

$$3x^2 = 2y \frac{dy}{dx}$$

$$\therefore \frac{dy}{dx} = \frac{3x^2}{2y}$$

b Differentiate both sides with respect to x :

$$\frac{d}{dx}(xy) = \frac{d}{dx}(2x + 1)$$

$$\frac{d}{dx}(xy) = 2$$

Use the product rule on the left-hand side:

$$y + x \frac{dy}{dx} = 2$$

$$\therefore \frac{dy}{dx} = \frac{2 - y}{x}$$

Example 24

Find $\frac{dy}{dx}$ if $x^2 + y^2 = 1$.

Solution

Note that $x^2 + y^2 = 1$ leads to

$$y = \pm\sqrt{1 - x^2} \quad \text{or} \quad x = \pm\sqrt{1 - y^2}$$

So y is not a function of x , and x is not a function of y . Implicit differentiation should be used. Since $x^2 + y^2 = 1$ is the unit circle, we can also find the derivative geometrically.

Method 1 (geometric)

Let $P(x, y)$ be a point on the unit circle with $x \neq 0$.

The gradient of OP is $\frac{\text{rise}}{\text{run}} = \frac{y}{x}$.

Since the radius is perpendicular to the tangent for a circle, the gradient of the tangent is $-\frac{x}{y}$, provided $y \neq 0$.

That is, $\frac{dy}{dx} = -\frac{x}{y}$.

From the graph, when $y = 0$ the tangents are parallel to the y -axis, hence $\frac{dy}{dx}$ is not defined.

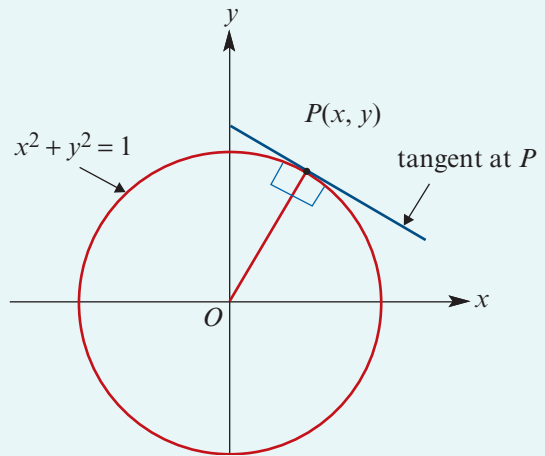
**Method 2 (implicit differentiation)**

$$x^2 + y^2 = 1$$

$$2x + 2y \frac{dy}{dx} = 0 \quad (\text{differentiate both sides with respect to } x)$$

$$\therefore 2y \frac{dy}{dx} = -2x$$

$$\therefore \frac{dy}{dx} = -\frac{x}{y} \quad \text{for } y \neq 0$$

Example 25

Given $xy - y - x^2 = 0$, find $\frac{dy}{dx}$.

Solution

Method 1 (express y as a function of x)

$$xy - y - x^2 = 0$$

$$y(x - 1) = x^2$$

$$y = \frac{x^2}{x - 1}$$

Therefore $y = x + 1 + \frac{1}{x - 1}$ for $x \neq 1$

$$\text{Hence } \frac{dy}{dx} = 1 - \frac{1}{(x - 1)^2}$$

$$= \frac{(x - 1)^2 - 1}{(x - 1)^2}$$

$$= \frac{x^2 - 2x}{(x - 1)^2} \quad \text{for } x \neq 1$$

Method 2 (implicit differentiation)

$$xy - y - x^2 = 0$$

$$\therefore \frac{d}{dx}(xy) - \frac{dy}{dx} - \frac{d}{dx}(x^2) = \frac{d}{dx}(0) \quad (\text{differentiate both sides with respect to } x)$$

$$\left(x \cdot \frac{dy}{dx} + y \cdot 1\right) - \frac{dy}{dx} - 2x = 0 \quad (\text{product rule})$$

$$x \frac{dy}{dx} - \frac{dy}{dx} = 2x - y$$

$$\frac{dy}{dx}(x - 1) = 2x - y$$

$$\therefore \frac{dy}{dx} = \frac{2x - y}{x - 1} \quad \text{for } x \neq 1$$

This can be checked, by substitution of $y = \frac{x^2}{x - 1}$, to confirm that the results are identical.



Example 26

Consider the curve with equation $2x^2 - 2xy + y^2 = 5$.

a Find $\frac{dy}{dx}$.

b Find the gradient of the tangent to the curve at the point (1, 3).

Solution

a Neither x nor y can be expressed as a function, so implicit differentiation must be used.

$$2x^2 - 2xy + y^2 = 5$$

$$\frac{d}{dx}(2x^2) - \frac{d}{dx}(2xy) + \frac{d}{dx}(y^2) = \frac{d}{dx}(5)$$

$$4x - \left(2x \cdot \frac{dy}{dx} + y \cdot 2\right) + 2y \frac{dy}{dx} = 0 \quad (\text{by the product and chain rules})$$

$$4x - 2x \frac{dy}{dx} - 2y + 2y \frac{dy}{dx} = 0$$

$$2y \frac{dy}{dx} - 2x \frac{dy}{dx} = 2y - 4x$$

$$\frac{dy}{dx}(2y - 2x) = 2y - 4x$$

$$\therefore \frac{dy}{dx} = \frac{2y - 4x}{2y - 2x}$$

$$= \frac{y - 2x}{y - x} \quad \text{for } x \neq y$$

b When $x = 1$ and $y = 3$, the gradient is $\frac{3 - 2}{3 - 1} = \frac{1}{2}$.

Using the TI-Nspire

- For implicit differentiation, use $\text{menu} >$ **Calculus** > **Implicit Differentiation** or just type `impdif(`.
- Complete as shown. This gives $\frac{dy}{dx}$ in terms of x and y .
- The gradient at the point $(1, 3)$ is found by substituting $x = 1$ and $y = 3$ as shown.

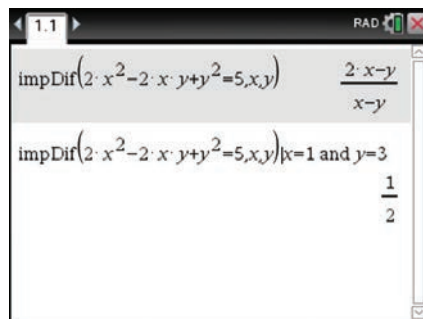

Note: If the positions of x and y are interchanged, then the result is $\frac{dx}{dy}$.

Using the Casio ClassPad

- Enter and highlight the equation $2x^2 - 2xy + y^2 = 5$.
- Go to **Interactive** > **Calculation** > **impDiff**.
- Complete with x as the independent variable and y as the dependent variable.

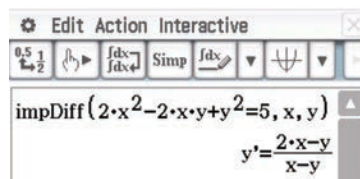

Exercise 10F

Skillsheet

- 1 For each of the following, find $\frac{dy}{dx}$ using implicit differentiation:

Example 23, 24

- | | | |
|-------------------------|----------------------------------|-----------------------------|
| a $x^2 - 2y = 3$ | b $x^2y = 1$ | c $x^3 + y^3 = 1$ |
| d $y^3 = x^2$ | e $x - \sqrt{y} = 2$ | f $xy - 2x + 3y = 0$ |
| g $y^2 = 4ax$ | h $4x + y^2 - 2y - 2 = 0$ | |

Example 25

- 2 Find $\frac{dy}{dx}$ for each of the following:

- | | | |
|--|--|------------------------------|
| a $(x + 2)^2 - y^2 = 4$ | b $\frac{1}{x} + \frac{1}{y} = 1$ | c $y = (x + y)^2$ |
| d $x^2 - xy + y^2 = 1$ | e $y = x^2e^y$ | f $\sin y = \cos^2 x$ |
| g $\sin(x - y) = \sin x - \sin y$ | h $y^5 - x \sin y + 3y^2 = 1$ | |

Example 26

- 3 For each of the following, find the equation of the tangent at the indicated point:

- | | |
|--|--|
| a $y^2 = 8x$ at $(2, -4)$ | b $x^2 - 9y^2 = 9$ at $(5, \frac{4}{3})$ |
| c $xy - y^2 = 1$ at $(\frac{17}{4}, 4)$ | d $\frac{x^2}{16} + \frac{y^2}{9} = 1$ at $(0, -3)$ |

- 4 Find $\frac{dy}{dx}$ in terms of x and y , given that $\ln(y) = \ln(x) + 1$.

- 5** Find the gradient of the curve $x^3 + y^3 = 9$ at the point $(1, 2)$.
- 6** A curve is defined by the equation $x^3 + y^3 + 3xy - 1 = 0$. Find the gradient of the curve at the point $(2, -1)$.
- 7** Given that $\tan x + \tan y = 3$, find the value of $\frac{dy}{dx}$ when $x = \frac{\pi}{4}$.
- 8** Find the gradient at the point $(1, -3)$ on the curve with equation $y^2 + xy - 2x^2 = 4$.
- 9** Consider the curve with equation $x^3 + y^3 = 28$.
- Obtain an expression for $\frac{dy}{dx}$.
 - Show that $\frac{dy}{dx}$ cannot be positive.
 - Calculate the value of $\frac{dy}{dx}$ when $x = 1$.
- 10** The equation of a curve is $2x^2 + 8xy + 5y^2 = -3$. Find the equation of the two tangents which are parallel to the x -axis.
- 11** The equation of a curve C is $x^3 + xy + 2y^3 = k$, where k is a constant.
- Find $\frac{dy}{dx}$ in terms of x and y .
 - The curve C has a tangent parallel to the y -axis. Show that the y -coordinate at the point of contact satisfies $216y^6 + 4y^3 + k = 0$.
 - Hence show that $k \leq \frac{1}{54}$.
 - Find the possible value(s) of k in the case where $x = -6$ is a tangent to C .
- 12** The equation of a curve is $x^2 - 2xy + 2y^2 = 4$.
- Find an expression for $\frac{dy}{dx}$ in terms of x and y .
 - Find the coordinates of each point on the curve at which the tangent is parallel to the x -axis.
- 13** Consider the curve with equation $y^2 + x^3 = 1$.
- Find $\frac{dy}{dx}$ in terms of x and y .
 - Find the coordinates of the points where $\frac{dy}{dx} = 0$.
 - Find the coordinates of the points where $\frac{dx}{dy} = 0$.
 - Describe the behaviour as $x \rightarrow -\infty$.
 - Express y in terms of x .
 - Find the coordinates of the points of inflection of the curve.
 - Use a calculator to help you sketch the graph of $y^2 + x^3 = 1$.



Chapter summary



Basic derivatives

$f(x)$	$f'(x)$
x^n	nx^{n-1}
e^{ax}	ae^{ax}
$\ln ax $	$\frac{1}{x}$

$f(x)$	$f'(x)$
$\sin(ax)$	$a \cos(ax)$
$\cos(ax)$	$-a \sin(ax)$
$\tan(ax)$	$a \sec^2(ax)$

$f(x)$	$f'(x)$
$\sin^{-1}\left(\frac{x}{a}\right)$	$\frac{1}{\sqrt{a^2 - x^2}}$
$\cos^{-1}\left(\frac{x}{a}\right)$	$\frac{-1}{\sqrt{a^2 - x^2}}$
$\tan^{-1}\left(\frac{x}{a}\right)$	$\frac{a}{a^2 + x^2}$

Rational functions

- A rational function has a rule of the form:

$$f(x) = \frac{a(x)}{b(x)} \quad \text{where } a(x) \text{ and } b(x) \text{ are polynomials}$$

$$= q(x) + \frac{r(x)}{b(x)} \quad (\text{quotient-remainder form})$$

- Vertical asymptotes occur where $b(x) = 0$.
- The non-vertical asymptote has equation $y = q(x)$.
- The x -axis intercepts occur where $a(x) = 0$.
- The y -axis intercept is $f(0) = \frac{a(0)}{b(0)}$, provided $b(0) \neq 0$.
- The stationary points occur where $f'(x) = 0$.
- If $f(x) = \frac{1}{b(x)}$, first sketch the graph of $y = b(x)$ and then use reciprocals of ordinates to sketch the graph of $y = f(x)$.
- If $f(x) = q(x) + \frac{r(x)}{b(x)}$, use addition of ordinates of $y = q(x)$ and $y = \frac{r(x)}{b(x)}$ to sketch the graph of $y = f(x)$.

Reciprocal functions

- The x -axis intercepts of the original function determine the equations of the asymptotes for the reciprocal function.
- The reciprocal of a positive number is positive.
- The reciprocal of a negative number is negative.
- A graph and its reciprocal will intersect at a point if the y -coordinate is 1 or -1 .
- Local maximums of the original function produce local minimums of the reciprocal.
- Local minimums of the original function produce local maximums of the reciprocal.
- If $g(x) = \frac{1}{f(x)}$, then $g'(x) = -\frac{f'(x)}{(f(x))^2}$. Therefore, at any given point, the gradient of the reciprocal function is opposite in sign to that of the original function.

Implicit differentiation

- Many curves are not defined by a rule of the form $y = f(x)$ or $x = f(y)$; for example, the unit circle $x^2 + y^2 = 1$. Implicit differentiation is used to find the gradient at a point on such a curve. To do this, we differentiate both sides of the equation with respect to x .
- Using operator notation:

$$\frac{d}{dx}(x^2 + y^2) = 2x + 2y \frac{dy}{dx} \quad (\text{use of chain rule})$$

$$\frac{d}{dx}(x^2y) = 2xy + x^2 \frac{dy}{dx} \quad (\text{use of product rule})$$

Short-answer questions

- Find $\frac{dy}{dx}$ if:

a $y = \ln|4 - 3x|$ **b** $y = \cos(\ln|x|)$ **c** $y = \cos^{-1}(2x + 1)$ **d** $y = \tan^{-1}(x + 1)$
e $y = x \tan x$ **f** $y = \tan(\tan^{-1} x)$ **g** $y = \cos(\sin^{-1} x)$ **h** $y = \sin^{-1}(2x - 1)$
- Find $f''(x)$ if:

a $f(x) = \tan x$ **b** $f(x) = \ln(\tan x)$ **c** $f(x) = x \sin^{-1} x$ **d** $f(x) = \sin(e^x)$
- Given that $f(x) = \tan^{-1}\left(\frac{1}{x-1}\right)$, find $f''(0)$.
- For each of the following, state the coordinates of the point(s) of inflection:

a $y = x^4 - 8x^3$ **b** $y = \sin^{-1}(x - 2)$ **c** $y = \frac{x^2 + 2}{x^2 + 1}$
- a** If $y = \sin(2x) + 3 \cos(2x)$, find:

i $\frac{dy}{dx}$ **ii** $\frac{d^2y}{dx^2}$

b Hence show that $\frac{d^2y}{dx^2} + 4y = 0$.
- Find $\frac{dy}{dx}$ for each of the following:

a $y = \frac{\ln x}{x}$ **b** $y = 1 - \tan^{-1}(1 - x)$ **c** $y = \ln\left(\frac{e^x}{e^x + 1}\right)$
d $x = \sqrt{\sin y + \cos y}$ **e** $y = \ln(x + \sqrt{1 + x^2})$ **f** $y = \sin^{-1}(e^x)$
- Let $f: \left[\pi, \frac{3\pi}{2}\right] \rightarrow \mathbb{R}$, $f(x) = \sin x$.

a Sketch the graphs of f and f^{-1} on the same set of axes.
b Find the derivative of f^{-1} .
c Find the coordinates of the point on the graph of f^{-1} where the tangent has a gradient of -2 .

- 8** This is the graph of $y = f(x)$.
Sketch the graphs of:

a $y = \frac{1}{f(x)}$
b $y = f^{-1}(x)$

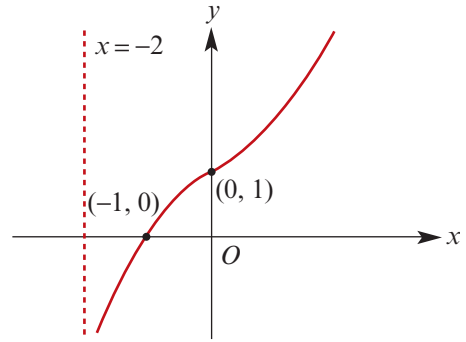

- 9** These are the graphs of $y = f(x)$ and $y = g(x)$, where f and g are quadratic functions.

- a** Sketch the graphs of:

i $y = f(x) + g(x)$

ii $y = \frac{1}{f(x) + g(x)}$

iii $y = \frac{1}{f(x)} + \frac{1}{g(x)}$

- b** Use the points given to determine the rules $y = f(x)$ and $y = g(x)$.

- c** Hence determine, in simplest form, the rules:

i $y = f(x) + g(x)$ **ii** $y = \frac{1}{f(x) + g(x)}$ **iii** $y = \frac{1}{f(x)} + \frac{1}{g(x)}$

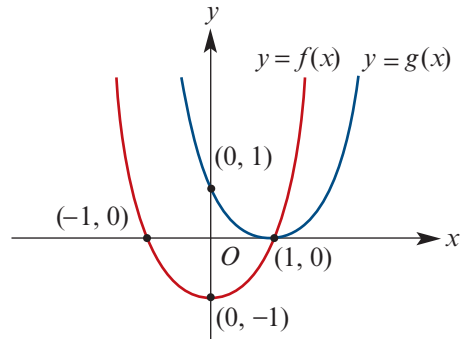

- 10** Find $\frac{dy}{dx}$ by implicit differentiation:

a $x^2 + 2xy + y^2 = 1$

b $x^2 + 2x + y^2 + 6y = 10$

c $\frac{2}{x} + \frac{1}{y} = 4$

d $(x + 1)^2 + (y - 3)^2 = 1$

- 11** A point moves along the curve $y = x^3$ in such a way that its velocity parallel to the x -axis is a constant 3 cm/s. Find its velocity parallel to the y -axis when:

a $x = 6$

b $y = 8$



Multiple-choice questions



- 1** The equation of the tangent to $x^2 + y^2 = 1$ at the point with coordinates $\left(\frac{1}{\sqrt{2}}, \frac{1}{\sqrt{2}}\right)$ is

A $y = -x$

B $y = -x + 2\sqrt{2}$

C $y = -x + 1$

D $y = -2\sqrt{x} + 2$

E $y = -x + \sqrt{2}$

- 2** If $f(x) = 2x^2 + 3x - 20$, then the graph of $y = \frac{1}{f(x)}$ has
- A** x -axis intercepts at $x = \frac{5}{2}$ and $x = -4$
B vertical asymptotes at $x = \frac{5}{2}$ and $x = 4$
C vertical asymptotes at $x = -\frac{5}{2}$ and $x = 4$
D a local minimum at the point $\left(\frac{-3}{4}, \frac{-169}{8}\right)$
E a local maximum at the point $\left(\frac{-3}{4}, \frac{-8}{169}\right)$
- 3** The points of inflection on the graph of $y = e^{-x} \sin x$ occur where
- A** $x = n\pi, n \in \mathbb{Z}$ **B** $x = 2n\pi, n \in \mathbb{Z}$ **C** $x = (2n + 1)\pi, n \in \mathbb{Z}$
D $x = \frac{(2n + 1)\pi}{2}, n \in \mathbb{Z}$ **E** $x = \frac{n\pi}{2}, n \in \mathbb{Z}$
- 4** Let $g(x) = \sin(x) \cdot f(x)$, where the function f is twice differentiable. If $(a, f(a))$ is not a stationary point on the graph of $y = f(x)$ and $(a, g(a))$ is a point of inflection on the graph of $y = g(x)$, then $f''(a)$ can be expressed in terms of $f(a)$ and $f'(a)$ as
- A** $f''(a) = f(a) - 2 \cot(a) \cdot f'(a)$ **B** $f''(a) = f(a) - 2 \tan(a) \cdot f'(a)$
C $f''(a) = f(a) + \cot(a) \cdot f'(a)$ **D** $f''(a) = f(a) - \tan(a) \cdot f'(a)$
E $f''(a) = f(a)$
- 5** If $x = t^2$ and $y = t^3$, then $\frac{dx}{dy}$ is equal to
- A** $\frac{1}{t}$ **B** $\frac{2}{3t}$ **C** $\frac{3t}{2}$ **D** $\frac{2t}{3}$ **E** $\frac{3}{2t}$
- 6** If $y = \cos^{-1}\left(\frac{4}{x}\right)$ and $x > 4$, then $\frac{dy}{dx}$ is equal to
- A** $\frac{-1}{\sqrt{16 - x^2}}$ **B** $\frac{-4}{\sqrt{1 - 16x^2}}$ **C** $\frac{-4x}{\sqrt{x^2 - 16}}$ **D** $\frac{4}{x\sqrt{x^2 - 16}}$ **E** $\frac{4}{\sqrt{x^2 - 16}}$
- 7** The coordinates of the turning point of the graph with equation $y = x^2 + \frac{54}{x}$ are
- A** (3, 0) **B** (-3, 27) **C** (3, 27) **D** (-3, 0) **E** (3, 2)
- 8** Let $y = \sin^{-1}\left(\frac{x}{2}\right)$ for $x \in [0, 1]$. Then $\frac{d^2y}{dx^2}$ is equal to
- A** $\cos^{-1}\left(\frac{x}{2}\right)$ **B** $x(4 - x^2)^{-\frac{3}{2}}$ **C** $\frac{-x}{\sqrt{4 - x^2}}$
D $\frac{-x}{\sqrt{4 - x^2}(4 - x^2)}$ **E** $\frac{-1}{\sqrt{4 - x^2}}$
- 9** If $y = \tan^{-1}\left(\frac{1}{3x}\right)$, then $\frac{dy}{dx}$ is equal to
- A** $\frac{1}{3(1 + x^2)}$ **B** $\frac{-1}{3(1 + x^2)}$ **C** $\frac{1}{3(1 + 9x^2)}$ **D** $\frac{-3}{9x^2 + 1}$ **E** $\frac{9x^2}{9x^2 + 1}$

- 10** Which of the following statements is false for the graph of $y = \cos^{-1}(x)$, for $x \in [-1, 1]$ and $y \in [0, \pi]$?
- A** The gradient of the graph is negative for $x \in (-1, 1)$.
- B** The graph has a point of inflection at $(0, \frac{\pi}{2})$.
- C** The gradient of the graph has a minimum value of -1 .
- D** The gradient of the graph is undefined at the point $(-1, \pi)$.
- E** At $x = \frac{1}{2}$, $y = \frac{\pi}{3}$.



Extended-response questions

- 1** The radius, r cm, and the height, h cm, of a solid circular cylinder vary in such a way that the volume of the cylinder is always 250π cm³.
- a** Show that the total surface area, A cm², of the cylinder is given by $A = 2\pi r^2 + \frac{500\pi}{r}$.
- b** **i** Sketch the graph of A against r for $r > 0$.
- ii** Give the equations of the asymptotes and the coordinates of the stationary points.
- c** What is the minimum total surface area?

- 2** A box with a volume of 1000 cm³ is to be made in the shape of a rectangular prism. It has a fixed height of 40 cm. The other dimensions are x cm and y cm as shown. The total surface area is A cm².

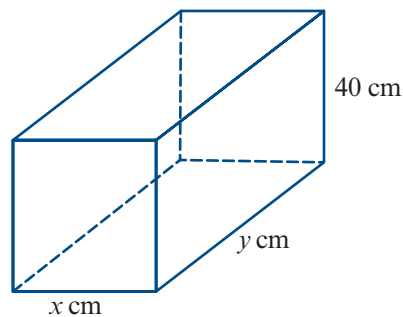

- a** Express A in terms of x .
- b** Sketch the graph of A against x .
- c** Find the minimum surface area of the box and the dimensions of the box in this situation.
- d** Find the minimum surface area of the box and the dimensions of the box if the height of the box is k cm (for a constant k) while the volume remains 1000 cm³.

- 3** This diagram shows a solid triangular prism with edge lengths as shown. All measurements are in cm. The volume is 2000 cm³. The surface area is A cm².

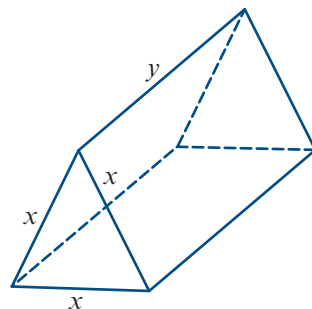

- a** Express A in terms of x and y .
- b** Establish a relationship between x and y .
- c** Hence express A in terms of x .
- d** Sketch the graph of A against x .
- e** Hence determine the minimum surface area of the prism.

- 4 a** Sketch the graph of $g: [0, 5] \rightarrow \mathbb{R}$, where $g(x) = 4 - \frac{8}{2 + x^2}$.
- b i** Find $g'(x)$. **ii** Find $g''(x)$.
- c** For what value of x is the gradient of the graph of $y = g(x)$ a maximum?
- d** Sketch the graph of $g: [-5, 5] \rightarrow \mathbb{R}$, where $g(x) = 4 - \frac{8}{2 + x^2}$.

- 5** The triangular prism as shown in the diagram has a right-angled triangle as its cross-section. The right angle is at C and C' on the ends of the prism. The volume of the prism is 3000 cm^3 . The dimensions of the prism are shown on the diagram. Assume that the volume remains constant and x varies.

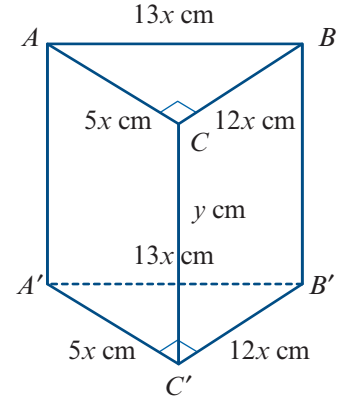

- a i** Find y in terms of x .
- ii** Find the total surface area, $S \text{ cm}^2$, in terms of x .
- iii** Sketch the graph of S against x for $x > 0$. Clearly label the asymptotes and the coordinates of the turning point.
- b** Given that x is increasing at a constant rate of 0.5 cm/s , find the rate at which S is increasing when $x = 9$.
- c** Find the values of x for which the surface area is 2000 cm^2 , correct to two decimal places.

- 6** The diagram shows part of the curve $x^2 - y^2 = 4$. The line segment PQ is parallel to the y -axis, and R is the point $(2, 0)$. The length of PQ is p .

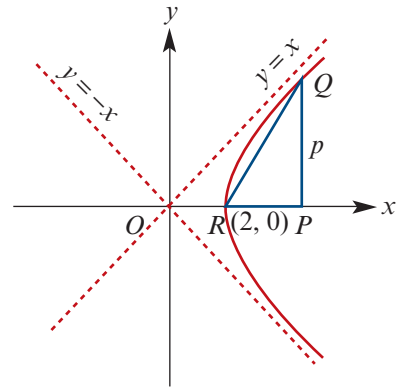

- a** Find the area, A , of triangle PQR in terms of p .
- b i** Find $\frac{dA}{dp}$.
- ii** Use your CAS calculator to help sketch the graph of A against p .
- iii** Find the value of p for which $A = 50$ (correct to two decimal places).
- iv** Prove that $\frac{dA}{dp} \geq 0$ for all p .
- c** Point Q moves along the curve and point P along the x -axis so that PQ is always parallel to the y -axis and p is increasing at a rate of 0.2 units per second. Find the rate at which A is increasing, correct to three decimal places, when:
- i** $p = 2.5$ **ii** $p = 4$ **iii** $p = 50$ **iv** $p = 80$
- (Use calculus to obtain the rate.)

- 7** Consider the family of cubic functions, i.e. $f: \mathbb{R} \rightarrow \mathbb{R}$, $f(x) = ax^3 + bx^2 + cx + d$.
- Find $f'(x)$.
 - Find $f''(x)$.
 - Under what conditions does the graph of f have no turning points?
 - Find the x -coordinate of the point where $y = f'(x)$ has a local minimum or maximum.
 - State the conditions for $y = f'(x)$ to have a local maximum.
 - If $a = 1$, find the x -coordinate of the stationary point of $y = f'(x)$.
 - For $y = x^3 + bx^2 + cx$, find:
 - the relationship between b and c if there is only one x -axis intercept
 - the relationship between b and c if there are two turning points but only one x -axis intercept.

- 8** A function is defined by the rule $f(x) = \frac{1-x^2}{1+x^2}$.
- Show that $f'(x) = \frac{-4x}{(1+x^2)^2}$.
 - Find $f''(x)$.
 - Sketch the graph of $y = f(x)$. Label the turning point and give the equation of the asymptote.
 - With the aid of a CAS calculator, sketch the graphs of $y = f(x)$, $y = f'(x)$ and $y = f''(x)$ for $x \in [-2, 2]$.
 - The graph of $y = f(x)$ crosses the x -axis at A and B and crosses the y -axis at C .
 - Find the equations of the tangents at A and B .
 - Show that they intersect at C .

- 9** The volume, V litres, of water in a pool at time t minutes is given by the rule

$$V = -3000\pi (\ln(1-h) + h)$$

where h metres is the depth of water in the pool at time t minutes.

- Find $\frac{dV}{dh}$ in terms of h .
 - Sketch the graph of $\frac{dV}{dh}$ against h for $0 \leq h \leq 0.9$.
- The maximum depth of the pool is 90 cm.
 - Find the maximum volume of the pool to the nearest litre.
 - Sketch the graphs of $y = -3000\pi \ln(1-x)$ and $y = -3000\pi x$. Use addition of ordinates to sketch the graph of V against h for $0 \leq h \leq 0.9$.
- If water is being poured into the pool at 15 litres/min, find the rate at which the depth of the water is increasing when $h = 0.2$, correct to two significant figures.

- 10 a** Let $f(x) = \tan^{-1}(x) + \tan^{-1}\left(\frac{1}{x}\right)$, for $x \neq 0$.
- i** Find $f'(x)$.
 - ii** If $x > 0$, find $f(x)$.
 - iii** If $x < 0$, find $f(x)$.
- b** Let $y = \cot x$, where $x \in (0, \pi)$.
- i** Find $\frac{dy}{dx}$.
 - ii** Find $\frac{dy}{dx}$ in terms of y .
- c** Find the derivative with respect to x of the function $y = \cot^{-1} x$, where $y \in (0, \pi)$ and $x \in \mathbb{R}$.
- d** Find the derivative with respect to x of $\cot(x) + \tan(x)$, where $x \in \left(0, \frac{\pi}{2}\right)$.
- 11** Consider the function $f: \mathbb{R}^+ \rightarrow \mathbb{R}$, where $f(x) = \frac{8}{x^2} - 32 + 16 \ln(2x)$.
- a** Find $f'(x)$.
 - b** Find $f''(x)$.
 - c** Find the exact coordinates of any stationary points of the graph of $y = f(x)$.
 - d** Find the exact value of x for which there is a point of inflection.
 - e** State the interval for x for which $f'(x) > 0$.
 - f** Find, correct to two decimal places, any x -axis intercepts other than $x = 0.5$.
 - g** Sketch the graph of $y = f(x)$.
- 12** An ellipse is described by the parametric equations $x = 3 \cos \theta$ and $y = 2 \sin \theta$.
- a** Show that the tangent to the ellipse at the point $P(3 \cos \theta, 2 \sin \theta)$ has equation $2x \cos \theta + 3y \sin \theta = 6$.
 - b** The tangent to the ellipse at the point $P(3 \cos \theta, 2 \sin \theta)$ meets the line with equation $x = 3$ at a point T .
 - i** Find the coordinates of the point T .
 - ii** Let A be the point with coordinates $(-3, 0)$ and let O be the origin. Prove that OT is parallel to AP .
 - c** The tangent to the ellipse at the point $P(3 \cos \theta, 2 \sin \theta)$ meets the x -axis at Q and the y -axis at R .
 - i** Find the midpoint M of the line segment QR in terms of θ .
 - ii** Find the locus of M as θ varies.
 - d** $W(-3 \sin \theta, 2 \cos \theta)$ and $P(3 \cos \theta, 2 \sin \theta)$ are points on the ellipse.
 - i** Find the equation of the tangent to the ellipse at W .
 - ii** Find the coordinates of Z , the point of intersection of the tangents at P and W , in terms of θ .
 - iii** Find the locus of Z as θ varies.
- 13** An ellipse has equation $\frac{x^2}{a^2} + \frac{y^2}{b^2} = 1$. The tangent at a point $P(a \cos \theta, b \sin \theta)$ intersects the axes at points M and N . The origin is O .
- a** Find the area of triangle OMN in terms of a , b and θ .
 - b** Find the values of θ for which the area of triangle OMN is a minimum and state this minimum area in terms of a and b .

- 14** A hyperbola is described by the parametric equations $x = a \sec \theta$ and $y = b \tan \theta$.
- Show that the equation of the tangent at the point $P(a \sec \theta, b \tan \theta)$ can be written as $\frac{x}{a} \sec \theta - \frac{y}{b} \tan \theta = 1$.
 - Find the coordinates of the points of intersection, Q and R , of the tangent with the asymptotes $y = \pm \frac{bx}{a}$ of the hyperbola.
 - Find the coordinates of the midpoint of the line segment QR .

- 15** A section of an ellipse is described by the parametric equations

$$x = 2 \cos \theta \quad \text{and} \quad y = \sin \theta \quad \text{for } 0 < \theta < \frac{\pi}{2}$$

The normal to the ellipse at the point $P(2 \cos \theta, \sin \theta)$ meets the x -axis at Q and the y -axis at R .

- Find the area of triangle OQR , where O is the origin, in terms of θ .
- Find the maximum value of this area and the value of θ for which this occurs.
- Find the midpoint, M , of the line segment QR in terms of θ .
- Find the locus of the point M as θ varies.

- 16** An electronic game appears on a flat screen, part of which is shown in the diagram. Concentric circles of radii one unit and two units appear on the screen.

Points P and Q move around the circles so that O , P and Q are collinear and OP makes an angle of θ with the x -axis.

A spaceship S moves around between the two circles and a gun is on the x -axis at G , which is 4 units from O .

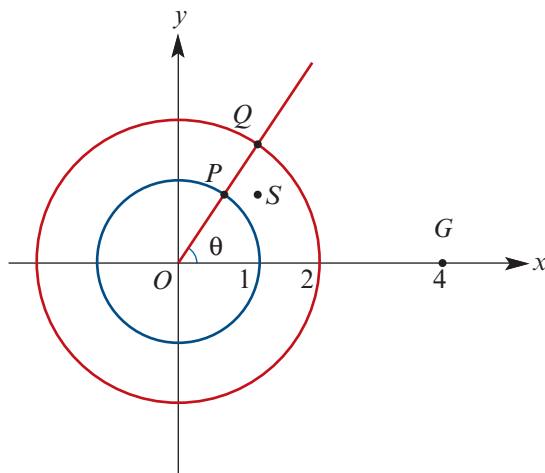

The spaceship moves so that at any time it is at a point (x, y) , where x is equal to the x -coordinate of Q and y is equal to the y -coordinate of P . The player turns the gun and tries to hit the spaceship.

- Find the Cartesian equation of the path C of S .
- Show that the equation of the tangent to C at the point (u, v) on C is $y = \frac{-u}{4v}x + \frac{1}{v}$.
- Show that in order to aim at the spaceship at any point on its path, the player needs to turn the gun through an angle of at most 2α , where $\tan \alpha = \frac{1}{6}\sqrt{3}$.



11

Techniques of integration

Objectives

- ▶ To review **antidifferentiation by rule**.
- ▶ To investigate the relationship between the graph of a function and the graphs of its antiderivatives.
- ▶ To use the inverse circular functions to find antiderivatives of the form

$$\int \frac{1}{\sqrt{a^2 - x^2}} dx \quad \text{and} \quad \int \frac{a}{a^2 + x^2} dx$$

- ▶ To apply the technique of **substitution** to integration.
- ▶ To apply **trigonometric identities** to integration.
- ▶ To apply **partial fractions** to integration.
- ▶ To use **integration by parts**.

Integration is used in many areas of this course. In the next chapter, integration is used to find areas and volumes. In Chapter 13, it is used to help solve differential equations, which are of great importance in mathematical modelling.

We begin this chapter by reviewing the methods of integration developed in Mathematical Methods Year 12.

In the remainder of the chapter, we introduce techniques for integrating many more functions. We will use the inverse circular functions, trigonometric identities, partial fractions and two techniques which can be described as ‘reversing’ the chain rule and the product rule.

11A Antidifferentiation

The derivative of x^2 with respect to x is $2x$. Conversely, given that an unknown expression has derivative $2x$, it is clear that the unknown expression could be x^2 . The process of finding a function from its derivative is called **antidifferentiation**.

Now consider the functions $f(x) = x^2 + 1$ and $g(x) = x^2 - 7$.

We have $f'(x) = 2x$ and $g'(x) = 2x$. So the two different functions have the same derivative function.

Both $x^2 + 1$ and $x^2 - 7$ are said to be **antiderivatives** of $2x$.

If two functions have the same derivative function, then they differ by a constant. So the graphs of the two functions can be obtained from each other by translation parallel to the y -axis.

The diagram shows several antiderivatives of $2x$.

Each of the graphs is a translation of $y = x^2$ parallel to the y -axis.

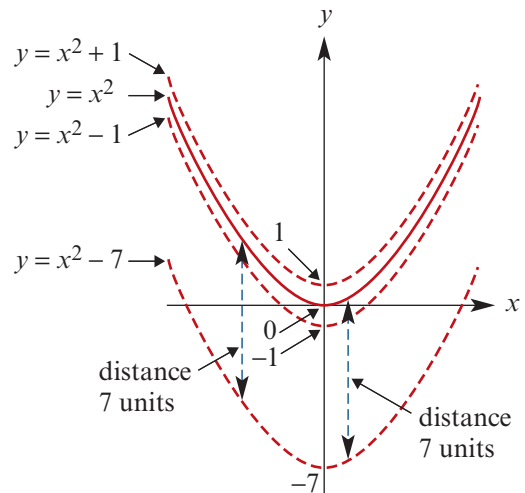

Notation

The general antiderivative of $2x$ is $x^2 + c$, where c is an arbitrary real number. We use the notation of Leibniz to state this with symbols:

$$\int 2x \, dx = x^2 + c$$

This is read as ‘the **general antiderivative** of $2x$ with respect to x is equal to $x^2 + c$ ’ or as ‘the **indefinite integral** of $2x$ with respect to x is $x^2 + c$ ’.

To be more precise, the indefinite integral is the set of all antiderivatives and to emphasise this we could write:

$$\int 2x \, dx = \{f(x) : f'(x) = 2x\} = \{x^2 + c : c \in \mathbb{R}\}$$

This set notation is not commonly used, but it should be clearly understood that there is not a unique antiderivative for a given function. We will not use this set notation, but it is advisable to keep it in mind when considering further results.

In general:

$$\text{If } F'(x) = f(x), \text{ then } \int f(x) \, dx = F(x) + c, \text{ where } c \text{ is an arbitrary real number.}$$

Basic antiderivatives

The following antiderivatives are covered in Mathematical Methods Year 12.

$f(x)$	$\int f(x) dx$	
x^n	$\frac{x^{n+1}}{n+1} + c$	where $n \neq -1$
$(ax+b)^n$	$\frac{1}{a(n+1)}(ax+b)^{n+1} + c$	where $n \neq -1$
x^{-1}	$\ln x + c$	for $x > 0$
$\frac{1}{ax+b}$	$\frac{1}{a} \ln(ax+b) + c$	for $ax+b > 0$
e^{ax+b}	$\frac{1}{a}e^{ax+b} + c$	
$\sin(ax+b)$	$-\frac{1}{a} \cos(ax+b) + c$	
$\cos(ax+b)$	$\frac{1}{a} \sin(ax+b) + c$	

The definite integral

For a continuous function f on an interval $[a, b]$, the **definite integral** $\int_a^b f(x) dx$ denotes the signed area enclosed by the graph of $y = f(x)$, the x -axis and the lines $x = a$ and $x = b$. By the fundamental theorem of calculus, we have

$$\int_a^b f(x) dx = F(b) - F(a)$$

where F is any antiderivative of f .

Note: In the expression $\int_a^b f(x) dx$, the number a is called the **lower limit** of integration and b the **upper limit** of integration. The function f is called the **integrand**.

We will review the fundamental theorem of calculus in Chapter 12. In this chapter, our focus is on developing techniques for calculating definite integrals using antidifferentiation.

Example 1

Find an antiderivative of each of the following:

a $\sin\left(3x - \frac{\pi}{4}\right)$

b e^{3x+4}

c $6x^3 - \frac{2}{x^2}$

Solution

a $\sin\left(3x - \frac{\pi}{4}\right)$ is of the form $\sin(ax+b)$

$$\int \sin(ax+b) dx = -\frac{1}{a} \cos(ax+b) + c$$

$$\therefore \int \sin\left(3x - \frac{\pi}{4}\right) dx = -\frac{1}{3} \cos\left(3x - \frac{\pi}{4}\right) + c$$

b e^{3x+4} is of the form e^{ax+b}

$$\int e^{ax+b} dx = \frac{1}{a} e^{ax+b} + c$$

$$\therefore \int e^{3x+4} dx = \frac{1}{3} e^{3x+4} + c$$

c $\int 6x^3 - \frac{2}{x^2} dx = \int 6x^3 - 2x^{-2} dx$

$$= \frac{6x^4}{4} + 2x^{-1} + c$$

$$= \frac{3}{2}x^4 + \frac{2}{x} + c$$

Example 2

Evaluate each of the following integrals:

a $\int_0^{\frac{\pi}{2}} \cos(3x) dx$

b $\int_0^1 e^{2x} - e^x dx$

c $\int_0^{\frac{\pi}{8}} \sec^2(2x) dx$

d $\int_0^1 \sqrt{2x+1} dx$

Solution

a $\int_0^{\frac{\pi}{2}} \cos(3x) dx = \left[\frac{1}{3} \sin(3x) \right]_0^{\frac{\pi}{2}}$

$$= \frac{1}{3} \left(\sin\left(\frac{3\pi}{2}\right) - \sin 0 \right)$$

$$= \frac{1}{3} (-1 - 0)$$

$$= -\frac{1}{3}$$

b $\int_0^1 e^{2x} - e^x dx = \left[\frac{1}{2} e^{2x} - e^x \right]_0^1$

$$= \frac{1}{2} e^2 - e^1 - \left(\frac{1}{2} e^0 - e^0 \right)$$

$$= \frac{e^2}{2} - e - \left(\frac{1}{2} - 1 \right)$$

$$= \frac{e^2}{2} - e + \frac{1}{2}$$

c From Chapter 10, we know that if $f(x) = \tan(ax+b)$, then $f'(x) = a \sec^2(ax+b)$. Hence

$$\int \sec^2(ax+b) dx = \frac{1}{a} \tan(ax+b) + c$$

$$\therefore \int_0^{\frac{\pi}{8}} \sec^2(2x) dx = \left[\frac{1}{2} \tan(2x) \right]_0^{\frac{\pi}{8}}$$

$$= \frac{1}{2} \left(\tan\left(\frac{\pi}{4}\right) - \tan 0 \right)$$

$$= \frac{1}{2} (1 - 0)$$

$$= \frac{1}{2}$$

d $\int_0^1 \sqrt{2x+1} dx = \int_0^1 (2x+1)^{\frac{1}{2}} dx$

$$= \left[\frac{1}{2 \times \frac{3}{2}} (2x+1)^{\frac{3}{2}} \right]_0^1$$

$$= \frac{1}{3} \left((2+1)^{\frac{3}{2}} - 1^{\frac{3}{2}} \right)$$

$$= \frac{1}{3} (3^{\frac{3}{2}} - 1)$$

$$= \frac{1}{3} (3\sqrt{3} - 1)$$

In the previous chapter, we showed that the derivative of $\ln|x|$ is $\frac{1}{x}$.

By the chain rule, the derivative of $\ln|ax+b|$ is $\frac{a}{ax+b}$.

This gives the following antiderivative.

$$\int \frac{1}{ax+b} dx = \frac{1}{a} \ln|ax+b| + c \quad \text{for } ax+b \neq 0$$

Example 3

a Find an antiderivative of $\frac{1}{4x+2}$.

b Evaluate $\int_0^1 \frac{1}{4x+2} dx$.

c Evaluate $\int_{-2}^{-1} \frac{1}{4x+2} dx$.

Solution

a $\frac{1}{4x+2}$ is of the form $\frac{1}{ax+b}$

$$\int \frac{1}{ax+b} dx = \frac{1}{a} \ln |ax+b| + c$$

$$\therefore \int \frac{1}{4x+2} dx = \frac{1}{4} \ln |4x+2| + c$$

$$\begin{aligned} \mathbf{b} \quad \int_0^1 \frac{1}{4x+2} dx &= \left[\frac{1}{4} \ln |4x+2| \right]_0^1 \\ &= \frac{1}{4} (\ln 6 - \ln 2) \\ &= \frac{1}{4} \ln 3 \end{aligned}$$

$$\begin{aligned} \mathbf{c} \quad \int_{-2}^{-1} \frac{1}{4x+2} dx &= \left[\frac{1}{4} \ln |4x+2| \right]_{-2}^{-1} \\ &= \frac{1}{4} (\ln |-2| - \ln |-6|) \\ &= \frac{1}{4} \ln \left(\frac{1}{3} \right) \\ &= -\frac{1}{4} \ln 3 \end{aligned}$$

► **Graphs of functions and their antiderivatives**

In each of the following examples in this section, the functions F and f are such that $F'(x) = f(x)$. That is, the function F is an antiderivative of f .

Example 4

Consider the graphs of $y = f(x)$ and $y = F(x)$ shown.

Find:

a $f(x)$

b $F(x)$

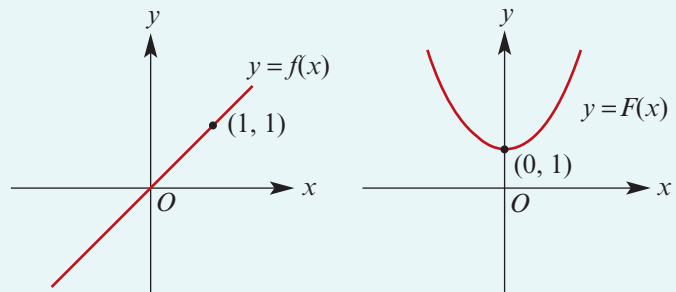
**Solution**

a $f(x) = mx$

Since $f(1) = 1$, we have $m = 1$.

Hence $f(x) = x$.

b $F(x) = \frac{x^2}{2} + c$ (by antidifferentiation)

But $F(0) = 1$ and therefore $c = 1$.

Hence $F(x) = \frac{x^2}{2} + 1$.

Note: The graph of $y = f(x)$ is the gradient graph for the graph of $y = F(x)$.

We have seen that there are infinitely many graphs defined by $\int f(x) dx$.

Example 5

The graph of $y = f(x)$ is as shown.

Sketch the graph of $y = F(x)$, given that $F(0) = 0$.

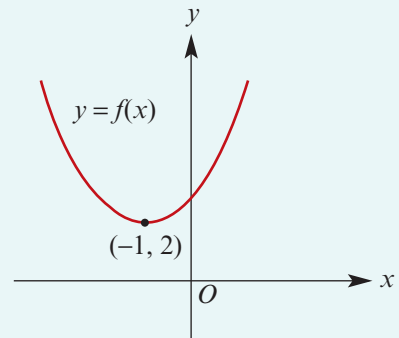

Solution

The given graph $y = f(x)$ is the gradient graph of $y = F(x)$.

Therefore the gradient of $y = F(x)$ is always positive.

The minimum gradient is 2 and this occurs when $x = -1$.

There is a line of symmetry $x = -1$, which indicates equal gradients for x -values equidistant from $x = -1$.

Also $F(0) = 0$.

A possible graph is shown.

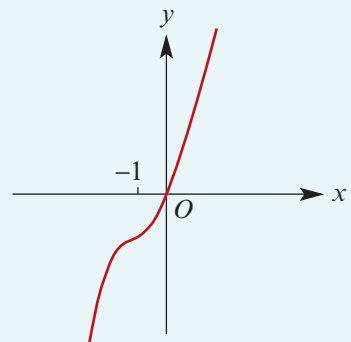

Example 6

The graph of $y = f(x)$ is as shown.

Sketch the graph of $y = F(x)$, given that $F(1) = 1$.

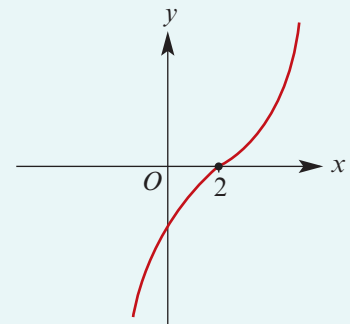

Solution

The given graph $y = f(x)$ is the gradient graph of $y = F(x)$.

Therefore the gradient of $y = F(x)$ is positive for $x > 2$, negative for $x < 2$ and zero for $x = 2$.

A possible graph is shown.

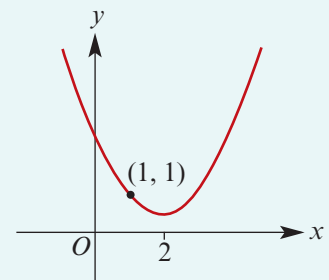

Exercise 11A

Example 1 1 Find an antiderivative of each of the following:

a $\sin\left(2x + \frac{\pi}{4}\right)$

b $\cos(\pi x)$

c $\sin\left(\frac{2\pi x}{3}\right)$

d e^{3x+1}

e $e^{5(x+4)}$

f $\frac{3}{2x^2}$

g $6x^3 - 2x^2 + 4x + 1$

Example 2 2 Evaluate each of the following integrals:

a $\int_{-1}^1 e^x - e^{-x} dx$

b $\int_0^2 3x^2 + 2x + 4 dx$

c $\int_0^{\frac{\pi}{2}} \sin(2x) dx$

d $\int_2^3 \frac{3}{x^3} dx$

e $\int_0^{\frac{\pi}{4}} \cos(x) + 2x dx$

f $\int_0^1 e^{3x} + x dx$

g $\int_0^{\frac{\pi}{2}} \cos(4x) dx$

h $\int_{-\frac{\pi}{2}}^{\frac{\pi}{2}} \sin\left(\frac{x}{2}\right) dx$

i $\int_0^{\frac{\pi}{4}} \sec^2 x dx$

Example 3 3 **a** Find an antiderivative of $\frac{1}{2x-5}$.

b Evaluate $\int_0^1 \frac{1}{2x-5} dx$.

c Evaluate $\int_{-2}^{-1} \frac{1}{2x-5} dx$.

4 Evaluate each of the following integrals:

a $\int_0^1 \frac{1}{3x+2} dx$

b $\int_{-3}^{-1} \frac{1}{3x-2} dx$

c $\int_{-1}^0 \frac{1}{4-3x} dx$

5 Find an antiderivative of each of the following:

a $(3x+2)^5$

b $\frac{1}{3x-2}$

c $\sqrt{3x+2}$

d $\frac{1}{(3x+2)^2}$

e $\frac{3x+1}{x+1}$

f $\cos\left(\frac{3x}{2}\right)$

g $(5x-1)^{\frac{1}{3}}$

h $\frac{2x+1}{x+3}$

Example 4 6 For each of the following, find the rules for $f(x)$ and $F(x)$, where $F'(x) = f(x)$:

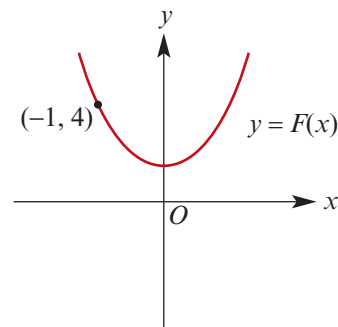
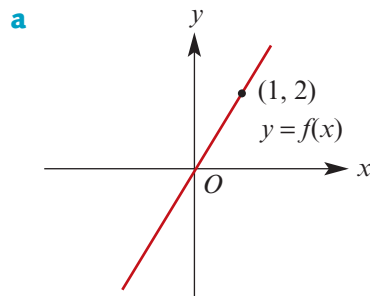

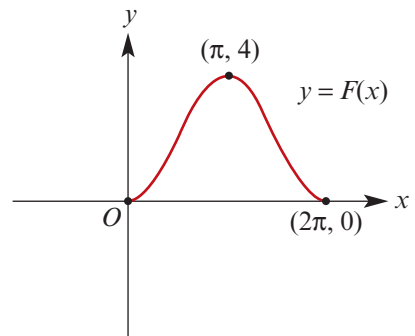
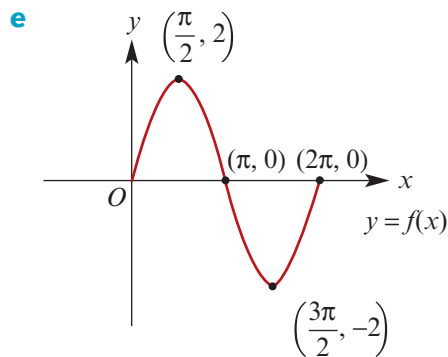
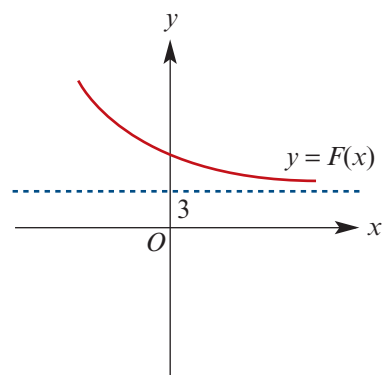
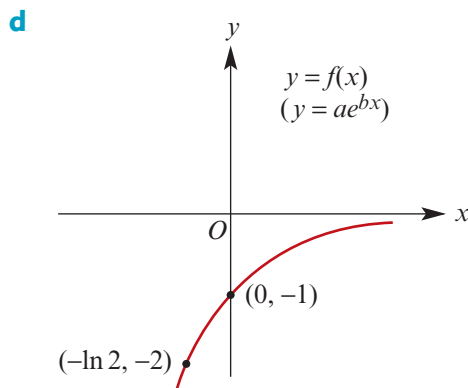
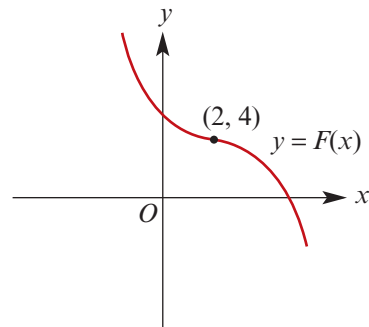
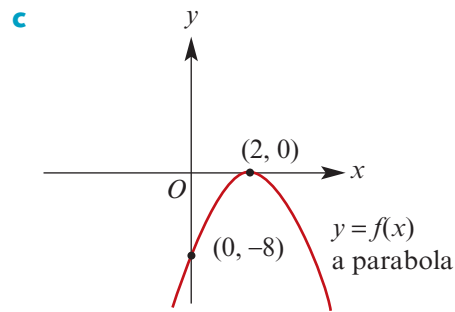
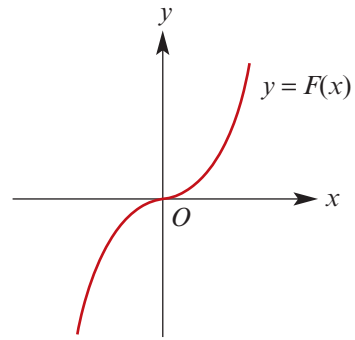
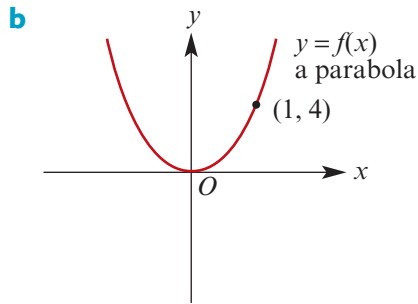

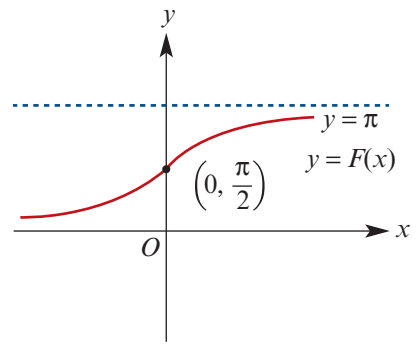
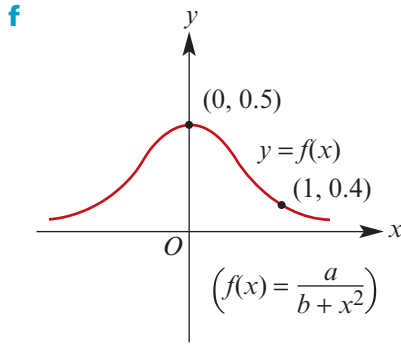

Example 5.6

7 For each of the following, use the given graph of $y = f(x)$ and the given value of $F(0)$ to sketch the graph of $y = F(x)$, where $F'(x) = f(x)$:

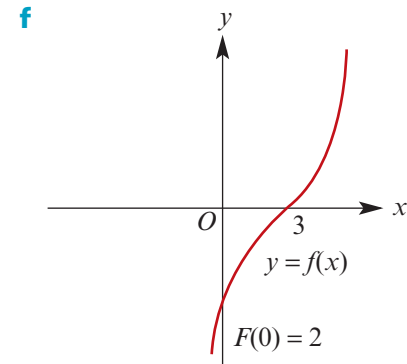
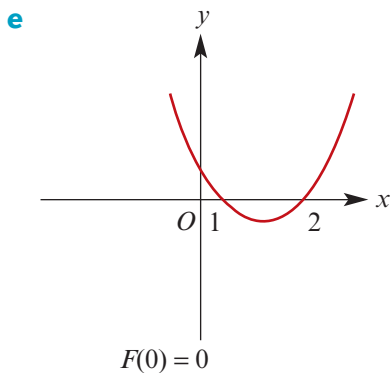
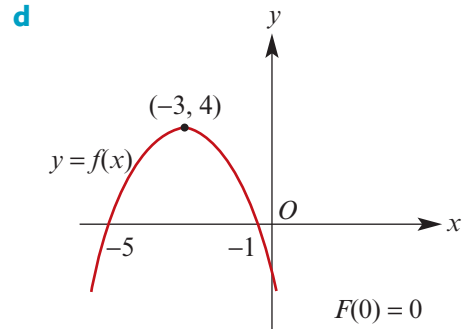
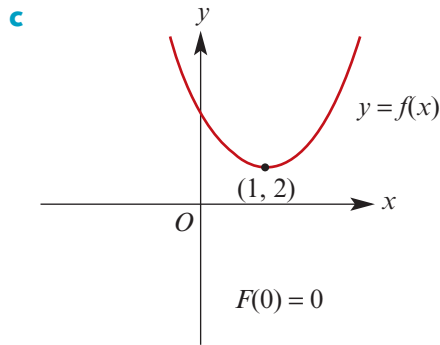
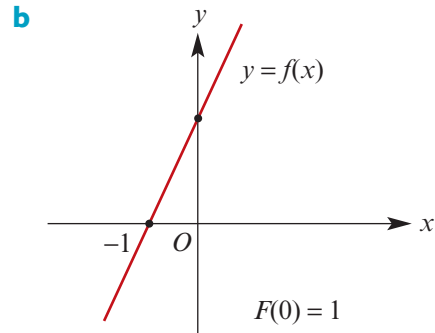
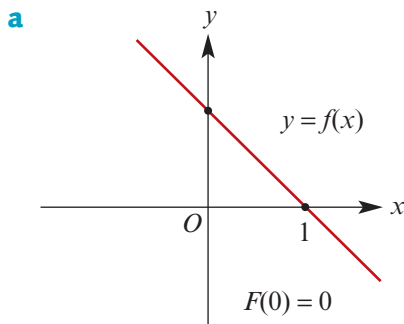

11B Antiderivatives involving inverse circular functions

In Chapter 10, the following rules for differentiation of inverse circular functions were established:

$$f: (-a, a) \rightarrow \mathbb{R}, \quad f(x) = \sin^{-1}\left(\frac{x}{a}\right), \quad f'(x) = \frac{1}{\sqrt{a^2 - x^2}}$$

$$f: (-a, a) \rightarrow \mathbb{R}, \quad f(x) = \cos^{-1}\left(\frac{x}{a}\right), \quad f'(x) = \frac{-1}{\sqrt{a^2 - x^2}}$$

$$f: \mathbb{R} \rightarrow \mathbb{R}, \quad f(x) = \tan^{-1}\left(\frac{x}{a}\right), \quad f'(x) = \frac{a}{a^2 + x^2}$$

From these results, the following can be stated:

$$\int \frac{1}{\sqrt{a^2 - x^2}} dx = \sin^{-1}\left(\frac{x}{a}\right) + c \quad \text{for } x \in (-a, a)$$

$$\int \frac{-1}{\sqrt{a^2 - x^2}} dx = \cos^{-1}\left(\frac{x}{a}\right) + c \quad \text{for } x \in (-a, a)$$

$$\int \frac{a}{a^2 + x^2} dx = \tan^{-1}\left(\frac{x}{a}\right) + c \quad \text{for } x \in \mathbb{R}$$

Note: It follows that $\sin^{-1}\left(\frac{x}{a}\right) + \cos^{-1}\left(\frac{x}{a}\right)$ must be constant for $x \in (-a, a)$.

By substituting $x = 0$, we can see that $\sin^{-1}\left(\frac{x}{a}\right) + \cos^{-1}\left(\frac{x}{a}\right) = \frac{\pi}{2}$ for all $x \in (-a, a)$.

Example 7

Find an antiderivative of each of the following:

a $\frac{1}{\sqrt{9 - x^2}}$

b $\frac{1}{\sqrt{9 - 4x^2}}$

c $\frac{1}{9 + 4x^2}$

Solution

a $\int \frac{1}{\sqrt{9 - x^2}} dx = \sin^{-1}\left(\frac{x}{3}\right) + c$

b
$$\begin{aligned} \int \frac{1}{\sqrt{9 - 4x^2}} dx &= \int \frac{1}{2\sqrt{\frac{9}{4} - x^2}} dx \\ &= \frac{1}{2} \int \frac{1}{\sqrt{\frac{9}{4} - x^2}} dx \\ &= \frac{1}{2} \sin^{-1}\left(\frac{2x}{3}\right) + c \end{aligned}$$

c
$$\begin{aligned} \int \frac{1}{9 + 4x^2} dx &= \int \frac{1}{4\left(\frac{9}{4} + x^2\right)} dx \\ &= \frac{2}{3} \int \frac{\frac{3}{2}}{4\left(\frac{9}{4} + x^2\right)} dx \\ &= \frac{1}{6} \int \frac{\frac{3}{2}}{\frac{9}{4} + x^2} dx \\ &= \frac{1}{6} \tan^{-1}\left(\frac{2x}{3}\right) + c \end{aligned}$$



Example 8

Evaluate each of the following definite integrals:

a $\int_0^1 \frac{1}{\sqrt{4-x^2}} dx$

b $\int_0^2 \frac{1}{4+x^2} dx$

c $\int_0^1 \frac{3}{\sqrt{9-4x^2}} dx$

Solution

a $\int_0^1 \frac{1}{\sqrt{4-x^2}} dx = \left[\sin^{-1}\left(\frac{x}{2}\right) \right]_0^1$
 $= \sin^{-1}\left(\frac{1}{2}\right) - \sin^{-1} 0$
 $= \frac{\pi}{6}$

b $\int_0^2 \frac{1}{4+x^2} dx = \frac{1}{2} \int_0^2 \frac{2}{4+x^2} dx$
 $= \frac{1}{2} \left[\tan^{-1}\left(\frac{x}{2}\right) \right]_0^2$
 $= \frac{1}{2} (\tan^{-1} 1 - \tan^{-1} 0)$
 $= \frac{\pi}{8}$

c $\int_0^1 \frac{3}{\sqrt{9-4x^2}} dx = \int_0^1 \frac{3}{2\sqrt{\frac{9}{4}-x^2}} dx$
 $= \frac{3}{2} \int_0^1 \frac{1}{\sqrt{\frac{9}{4}-x^2}} dx$
 $= \frac{3}{2} \left[\sin^{-1}\left(\frac{2x}{3}\right) \right]_0^1$
 $= \frac{3}{2} \sin^{-1}\left(\frac{2}{3}\right)$
 ≈ 1.095

Exercise 11B

Example 7

1 Find each of the following integrals:

a $\int \frac{1}{\sqrt{9-x^2}} dx$

b $\int \frac{1}{5+x^2} dx$

c $\int \frac{1}{1+t^2} dt$

d $\int \frac{5}{\sqrt{5-x^2}} dx$

e $\int \frac{3}{16+x^2} dx$

f $\int \frac{1}{\sqrt{16-4x^2}} dx$

g $\int \frac{10}{\sqrt{10-t^2}} dt$

h $\int \frac{1}{9+16t^2} dt$

i $\int \frac{1}{\sqrt{5-2x^2}} dx$

j $\int \frac{7}{3+y^2} dy$

Example 8

2 Evaluate each of the following:

a $\int_0^1 \frac{2}{1+x^2} dx$

b $\int_0^{\frac{1}{2}} \frac{3}{\sqrt{1-x^2}} dx$

c $\int_0^1 \frac{5}{\sqrt{4-x^2}} dx$

d $\int_0^5 \frac{6}{25+x^2} dx$

e $\int_0^{\frac{3}{2}} \frac{3}{9+4x^2} dx$

f $\int_0^2 \frac{1}{8+2x^2} dx$

g $\int_0^{\frac{3}{2}} \frac{1}{\sqrt{9-x^2}} dx$

h $\int_0^{\frac{3\sqrt{2}}{4}} \frac{1}{\sqrt{9-4x^2}} dx$

i $\int_0^{\frac{1}{3}} \frac{3}{\sqrt{1-9y^2}} dy$

j $\int_0^2 \frac{1}{1+3x^2} dx$



11C Integration by substitution

In this section, we introduce the technique of substitution. The substitution will result in one of the forms for integrands covered in Sections 11A and 11B.

First consider the following example.



Example 9

Differentiate each of the following with respect to x :

a $(2x^2 + 1)^5$

b $\cos^3 x$

c e^{3x^2}

Solution

a Let $y = (2x^2 + 1)^5$ and $u = 2x^2 + 1$.

$$\text{Then } y = u^5, \frac{dy}{du} = 5u^4 \text{ and } \frac{du}{dx} = 4x.$$

By the chain rule for differentiation:

$$\begin{aligned} \frac{dy}{dx} &= \frac{dy}{du} \frac{du}{dx} \\ &= 5u^4 \cdot 4x \\ &= 20u^4 x \\ &= 20x(2x^2 + 1)^4 \end{aligned}$$

b Let $y = \cos^3 x$ and $u = \cos x$.

$$\text{Then } y = u^3, \frac{dy}{du} = 3u^2 \text{ and } \frac{du}{dx} = -\sin x.$$

By the chain rule for differentiation:

$$\begin{aligned} \frac{dy}{dx} &= \frac{dy}{du} \frac{du}{dx} \\ &= 3u^2 \cdot (-\sin x) \\ &= 3\cos^2 x \cdot (-\sin x) \\ &= -3\cos^2 x \sin x \end{aligned}$$

c Let $y = e^{3x^2}$ and $u = 3x^2$.

$$\text{Then } y = e^u, \frac{dy}{du} = e^u \text{ and } \frac{du}{dx} = 6x.$$

By the chain rule for differentiation:

$$\begin{aligned} \frac{dy}{dx} &= \frac{dy}{du} \frac{du}{dx} \\ &= e^u \cdot 6x \\ &= 6xe^{3x^2} \end{aligned}$$

This example suggests that a ‘converse’ of the chain rule can be used to obtain a method for antidifferentiating functions of a particular form.

■ From Example 9a: $\int 20x(2x^2 + 1)^4 dx = (2x^2 + 1)^5 + c$

This is of the form: $\int 5h'(x)(h(x))^4 dx = (h(x))^5 + c$ where $h(x) = 2x^2 + 1$

■ From Example 9b: $\int -3\cos^2 x \sin x dx = \cos^3 x + c$

This is of the form: $\int 3h'(x)(h(x))^2 dx = (h(x))^3 + c$ where $h(x) = \cos x$

■ From Example 9c: $\int 6xe^{3x^2} dx = e^{3x^2} + c$

This is of the form: $\int h'(x)e^{h(x)} dx = e^{h(x)} + c$ where $h(x) = 3x^2$

This suggests a method that can be used for integration.

$$\text{e.g. } \int 2x(x^2 + 1)^5 dx = \frac{(x^2 + 1)^6}{6} + c \quad [h(x) = x^2 + 1]$$

$$\int \cos x \sin x dx = \frac{\sin^2 x}{2} + c \quad [h(x) = \sin x]$$

A formalisation of this idea provides a method for integrating functions of this form.

Let $y = \int f(u) du$, where $u = g(x)$.

By the chain rule for differentiation:

$$\begin{aligned} \frac{dy}{dx} &= \frac{dy}{du} \frac{du}{dx} \\ &= f(u) \cdot \frac{du}{dx} \end{aligned}$$

$$\therefore y = \int f(u) \frac{du}{dx} dx$$

This gives the following technique for integration.

Integration by substitution

$$\int f(u) \frac{du}{dx} dx = \int f(u) du$$

This is also called the **change of variable rule**.

Example 10

Find an antiderivative of each of the following:

a $\sin x \cos^2 x$

b $5x^2(x^3 - 1)^{\frac{1}{2}}$

c $3xe^{x^2}$

Solution

a $\int \sin x \cos^2 x dx$

Let $u = \cos x$. Then $f(u) = u^2$ and $\frac{du}{dx} = -\sin x$.

$$\begin{aligned} \therefore \int \sin x \cos^2 x dx &= -\int \cos^2 x \cdot (-\sin x) dx \\ &= -\int f(u) \frac{du}{dx} dx \\ &= -\int f(u) du \\ &= -\int u^2 du \\ &= -\frac{u^3}{3} + c \\ &= -\frac{\cos^3 x}{3} + c \end{aligned}$$

$$\mathbf{b} \int 5x^2(x^3 - 1)^{\frac{1}{2}} dx$$

$$\text{Let } u = x^3 - 1.$$

$$\text{Then } f(u) = u^{\frac{1}{2}} \text{ and } \frac{du}{dx} = 3x^2.$$

$$\begin{aligned} \therefore \int 5x^2(x^3 - 1)^{\frac{1}{2}} dx &= \frac{5}{3} \int (x^3 - 1)^{\frac{1}{2}} \cdot 3x^2 dx \\ &= \frac{5}{3} \int u^{\frac{1}{2}} \frac{du}{dx} dx \\ &= \frac{5}{3} \int u^{\frac{1}{2}} du \\ &= \frac{5}{3} \left(\frac{2}{3} u^{\frac{3}{2}} \right) + c \\ &= \frac{10}{9} u^{\frac{3}{2}} + c \\ &= \frac{10}{9} (x^3 - 1)^{\frac{3}{2}} + c \end{aligned}$$

$$\mathbf{c} \int 3xe^{x^2} dx$$

$$\text{Let } u = x^2.$$

$$\text{Then } f(u) = e^u \text{ and } \frac{du}{dx} = 2x.$$

$$\begin{aligned} \therefore \int 3xe^{x^2} dx &= \frac{3}{2} \int e^u \cdot 2x dx \\ &= \frac{3}{2} \int e^u \frac{du}{dx} dx \\ &= \frac{3}{2} \int e^u du \\ &= \frac{3}{2} e^u + c \\ &= \frac{3}{2} e^{x^2} + c \end{aligned}$$



Example 11

Find an antiderivative of each of the following:

$$\mathbf{a} \frac{2}{x^2 + 2x + 6}$$

$$\mathbf{b} \frac{3}{\sqrt{9 - 4x - x^2}}$$

Solution

a Completing the square gives

$$\begin{aligned} x^2 + 2x + 6 &= x^2 + 2x + 1 + 5 \\ &= (x + 1)^2 + 5 \end{aligned}$$

Therefore

$$\int \frac{2}{x^2 + 2x + 6} dx = \int \frac{2}{(x + 1)^2 + 5} dx$$

Let $u = x + 1$. Then $\frac{du}{dx} = 1$ and hence

$$\begin{aligned} \int \frac{2}{(x + 1)^2 + 5} dx &= \int \frac{2}{u^2 + 5} du \\ &= \frac{2}{\sqrt{5}} \int \frac{\sqrt{5}}{u^2 + 5} du \\ &= \frac{2}{\sqrt{5}} \tan^{-1} \left(\frac{u}{\sqrt{5}} \right) + c \\ &= \frac{2}{\sqrt{5}} \tan^{-1} \left(\frac{x + 1}{\sqrt{5}} \right) + c \end{aligned}$$

$$\mathbf{b} \int \frac{3}{\sqrt{9-4x-x^2}} dx$$

Completing the square gives

$$\begin{aligned} 9-4x-x^2 &= -(x^2+4x-9) \\ &= -((x+2)^2-13) \\ &= 13-(x+2)^2 \end{aligned}$$

Therefore

$$\int \frac{3}{\sqrt{9-4x-x^2}} dx = \int \frac{3}{\sqrt{13-(x+2)^2}} dx$$

Let $u = x + 2$. Then $\frac{du}{dx} = 1$ and hence

$$\begin{aligned} \int \frac{3}{\sqrt{13-(x+2)^2}} dx &= \int \frac{3}{\sqrt{13-u^2}} du \\ &= 3 \sin^{-1}\left(\frac{u}{\sqrt{13}}\right) + c \\ &= 3 \sin^{-1}\left(\frac{x+2}{\sqrt{13}}\right) + c \end{aligned}$$

► Linear substitutions

Antiderivatives of expressions such as

$$(2x+3)\sqrt{3x-4}, \quad \frac{2x+5}{\sqrt{3x-4}}, \quad \frac{2x+5}{(x+2)^2}, \quad (2x+4)(x+3)^{20}, \quad x^2\sqrt{3x-1}$$

can be found using a linear substitution.



Example 12

Find an antiderivative of each of the following:

a $(2x+1)\sqrt{x+4}$

b $\frac{2x+1}{(1-2x)^2}$

c $x^2\sqrt{3x-1}$

Solution

a Let $u = x + 4$. Then $\frac{du}{dx} = 1$ and $x = u - 4$.

$$\begin{aligned} \therefore \int (2x+1)\sqrt{x+4} dx &= \int (2(u-4)+1)u^{\frac{1}{2}} du \\ &= \int (2u-7)u^{\frac{1}{2}} du \\ &= \int 2u^{\frac{3}{2}} - 7u^{\frac{1}{2}} du \\ &= 2\left(\frac{2}{5}u^{\frac{5}{2}}\right) - 7\left(\frac{2}{3}u^{\frac{3}{2}}\right) + c \\ &= \frac{4}{5}(x+4)^{\frac{5}{2}} - \frac{14}{3}(x+4)^{\frac{3}{2}} + c \end{aligned}$$

$$\mathbf{b} \int \frac{2x+1}{(1-2x)^2} dx$$

Let $u = 1 - 2x$. Then $\frac{du}{dx} = -2$ and $2x = 1 - u$.

Therefore

$$\begin{aligned} \int \frac{2x+1}{(1-2x)^2} dx &= -\frac{1}{2} \int \frac{2-u}{u^2} (-2) dx \\ &= -\frac{1}{2} \int \frac{2-u}{u^2} \frac{du}{dx} dx \\ &= -\frac{1}{2} \int 2u^{-2} - u^{-1} du \\ &= -\frac{1}{2}(-2u^{-1} - \ln|u|) + c \\ &= u^{-1} + \frac{1}{2} \ln|u| + c \\ &= \frac{1}{1-2x} + \frac{1}{2} \ln|1-2x| + c \end{aligned}$$

$$\mathbf{c} \int x^2 \sqrt{3x-1} dx$$

Let $u = 3x - 1$. Then $\frac{du}{dx} = 3$.

We have $x = \frac{u+1}{3}$ and so $x^2 = \frac{(u+1)^2}{9}$.

Therefore

$$\begin{aligned} \int x^2 \sqrt{3x-1} dx &= \int \frac{(u+1)^2}{9} \sqrt{u} dx \\ &= \frac{1}{27} \int (u+1)^2 u^{\frac{1}{2}} (3) dx \\ &= \frac{1}{27} \int (u^2 + 2u + 1) u^{\frac{1}{2}} \frac{du}{dx} dx \\ &= \frac{1}{27} \int u^{\frac{5}{2}} + 2u^{\frac{3}{2}} + u^{\frac{1}{2}} du \\ &= \frac{1}{27} \left(\frac{2}{7} u^{\frac{7}{2}} + \frac{4}{5} u^{\frac{5}{2}} + \frac{2}{3} u^{\frac{3}{2}} \right) + c \\ &= \frac{2}{27} u^{\frac{3}{2}} \left(\frac{1}{7} u^2 + \frac{2}{5} u + \frac{1}{3} \right) + c \\ &= \frac{2}{2835} (3x-1)^{\frac{3}{2}} (15(3x-1)^2 + 42(3x-1) + 35) + c \\ &= \frac{2}{2835} (3x-1)^{\frac{3}{2}} (135x^2 + 36x + 8) + c \end{aligned}$$

Using the TI-Nspire

- To find an antiderivative, use $\text{menu} > \text{Calculus} > \text{Integral}$.
- Use **factor** from the **Algebra** menu to obtain the required form.

$$\int x^2 \cdot \sqrt{3-x-1} dx$$

$$\frac{2 \cdot x^2 \cdot (3-x-1)^{\frac{3}{2}}}{21} + \frac{8 \cdot x \cdot (3-x-1)^{\frac{3}{2}}}{315} + \frac{16 \cdot (3-x-1)^{\frac{3}{2}}}{28}$$

$$\text{factor} \left(\frac{2 \cdot x^2 \cdot (3-x-1)^{\frac{3}{2}}}{21} + \frac{8 \cdot x \cdot (3-x-1)^{\frac{3}{2}}}{315} + \frac{16 \cdot (3-x-1)^{\frac{3}{2}}}{28} \right)$$

$$\frac{2 \cdot (3-x-1)^{\frac{3}{2}} \cdot (135 \cdot x^2 + 36 \cdot x + 8)}{2835}$$

Note: The integral template can also be obtained directly from the 2D-template palette [2D] or by pressing $\text{[shift]} + \text{[2]}$.

Using the Casio ClassPad

- Enter and highlight the expression $x^2 \sqrt{3-x-1}$.
- Go to **Interactive** > **Calculation** > \int . Make sure that **Indefinite** is selected and that x is the variable.
- Simplify the resulting expression.

Edit Action Interactive

$\int x^2 \sqrt{3-x-1} dx$

$$\frac{2 \cdot (135 \cdot x^2 + 36 \cdot x + 8) \cdot (3-x-1)^{\frac{3}{2}}}{2835}$$

Exercise 11C

Example 10

1 Find each of the following:

a $\int 2x(x^2 + 1)^3 dx$

b $\int \frac{x}{(x^2 + 1)^2} dx$

c $\int \cos x \sin^3 x dx$

d $\int \frac{\cos x}{\sin^2 x} dx$

e $\int (2x + 1)^5 dx$

f $\int 5x\sqrt{9+x^2} dx$

g $\int x(x^2 - 3)^5 dx$

h $\int \frac{x+1}{(x^2 + 2x)^3} dx$

i $\int \frac{2}{(3x+1)^3} dx$

j $\int \frac{1}{\sqrt{1+x}} dx$

k $\int (x^2 - 2x)(x^3 - 3x^2 + 1)^4 dx$

l $\int \frac{3x}{x^2 + 1} dx$

m $\int \frac{3x}{2-x^2} dx$

Example 11 2 Find an antiderivative of each of the following:

a $\frac{1}{x^2 + 2x + 2}$

b $\frac{1}{x^2 - x + 1}$

c $\frac{1}{\sqrt{21 - 4x - x^2}}$

d $\frac{1}{\sqrt{10x - x^2 - 24}}$

e $\frac{1}{\sqrt{40 - x^2 - 6x}}$

f $\frac{1}{3x^2 + 6x + 7}$

Example 12 3 Find an antiderivative of each of the following:

a $x\sqrt{2x + 3}$

b $x\sqrt{1 - x}$

c $6x(3x - 7)^{-\frac{1}{2}}$

d $(2x + 1)\sqrt{3x - 1}$

e $\frac{2x - 1}{(x - 1)^2}$

f $(x + 3)\sqrt{3x + 1}$

g $(x + 2)(x + 3)^{\frac{1}{3}}$

h $\frac{5x - 1}{(2x + 1)^2}$

i $x^2\sqrt{x - 1}$



j $\frac{x^2}{\sqrt{x - 1}}$

11D Definite integrals by substitution

Example 13

Evaluate $\int_0^4 3x\sqrt{x^2 + 9} dx$.

Solution

Let $u = x^2 + 9$. Then $\frac{du}{dx} = 2x$ and so

$$\begin{aligned} \int 3x\sqrt{x^2 + 9} dx &= \frac{3}{2} \int \sqrt{x^2 + 9} \cdot 2x dx \\ &= \frac{3}{2} \int u^{\frac{1}{2}} \frac{du}{dx} dx \\ &= \frac{3}{2} \int u^{\frac{1}{2}} du \\ &= \frac{3}{2} \left(\frac{2}{3} u^{\frac{3}{2}} \right) + c \\ &= u^{\frac{3}{2}} + c \\ &= (x^2 + 9)^{\frac{3}{2}} + c \end{aligned}$$

$$\begin{aligned} \therefore \int_0^4 3x\sqrt{x^2 + 9} dx &= \left[(x^2 + 9)^{\frac{3}{2}} \right]_0^4 \\ &= 25^{\frac{3}{2}} - 9^{\frac{3}{2}} \\ &= 125 - 27 = 98 \end{aligned}$$

In a definite integral which involves the change of variable rule, it is not necessary to return to an expression in x if the values of u corresponding to each of the limits of x are found.

For the previous example:

- $x = 0$ implies $u = 9$
- $x = 4$ implies $u = 25$

Therefore the integral can be evaluated as

$$\frac{3}{2} \int_9^{25} u^{\frac{1}{2}} du = \frac{3}{2} \left[\frac{2}{3} u^{\frac{3}{2}} \right]_9^{25} = 125 - 27 = 98$$

Example 14

Evaluate the following:

a $\int_0^{\frac{\pi}{2}} \cos^3 x \, dx$

b $\int_0^1 2x^2 e^{x^3} \, dx$

Solution

a
$$\begin{aligned} \int_0^{\frac{\pi}{2}} \cos^3 x \, dx &= \int_0^{\frac{\pi}{2}} \cos x (\cos^2 x) \, dx \\ &= \int_0^{\frac{\pi}{2}} \cos x (1 - \sin^2 x) \, dx \end{aligned}$$

Let $u = \sin x$. Then $\frac{du}{dx} = \cos x$.

When $x = \frac{\pi}{2}$, $u = 1$ and when $x = 0$, $u = 0$.

Therefore the integral becomes

$$\begin{aligned} \int_0^1 (1 - u^2) \, du &= \left[u - \frac{u^3}{3} \right]_0^1 \\ &= 1 - \frac{1}{3} = \frac{2}{3} \end{aligned}$$

b $\int_0^1 2x^2 e^{x^3} \, dx$

Let $u = x^3$. Then $\frac{du}{dx} = 3x^2$.

When $x = 1$, $u = 1$ and when $x = 0$, $u = 0$.

We have

$$\begin{aligned} \frac{2}{3} \int_0^1 e^{x^3} \cdot (3x^2) \, dx &= \frac{2}{3} \int_0^1 e^u \, du \\ &= \frac{2}{3} [e^u]_0^1 \\ &= \frac{2}{3} (e^1 - e^0) \\ &= \frac{2}{3} (e - 1) \end{aligned}$$

Exercise 11D

Skillsheet

1 Evaluate each of the following definite integrals:

Example 13, 14

a $\int_0^3 x\sqrt{x^2 + 16} \, dx$

b $\int_0^{\frac{\pi}{4}} \cos x \sin^3 x \, dx$

c $\int_0^{\frac{\pi}{2}} \sin x \cos^2 x \, dx$

d $\int_3^4 x(x-3)^{17} \, dx$

e $\int_0^1 x\sqrt{1-x} \, dx$

f $\int_e^{e^2} \frac{1}{x \ln x} \, dx$

g $\int_0^4 \frac{1}{\sqrt{3x+4}} \, dx$

h $\int_{-1}^1 \frac{e^x}{e^x + 1} \, dx$

i $\int_0^{\frac{\pi}{4}} \frac{\sin x}{\cos^3 x} \, dx$

j $\int_0^1 \frac{2x+3}{x^2+3x+4} \, dx$

k $\int_{\frac{\pi}{4}}^{\frac{\pi}{3}} \frac{\cos x}{\sin x} \, dx$

l $\int_{-4}^{-3} \frac{2x}{1-x^2} \, dx$



m $\int_{-2}^{-1} \frac{e^x}{1-e^x} \, dx$

11E Use of trigonometric identities for integration

▶ Products of sines and cosines

Integrals of the form $\int \sin^m x \cos^n x \, dx$, where m and n are non-negative integers, can be considered in the following three cases.

Case A: the power of sine is odd

If m is odd, write $m = 2k + 1$. Then

$$\begin{aligned} \sin^{2k+1} x &= (\sin^2 x)^k \sin x \\ &= (1 - \cos^2 x)^k \sin x \end{aligned}$$

and the substitution $u = \cos x$ can now be made.

Case B: the power of cosine is odd

If m is even and n is odd, write $n = 2k + 1$. Then

$$\begin{aligned} \cos^{2k+1} x &= (\cos^2 x)^k \cos x \\ &= (1 - \sin^2 x)^k \cos x \end{aligned}$$

and the substitution $u = \sin x$ can now be made.

Case C: both powers are even

If both m and n are even, then the identity $\sin^2 x = \frac{1}{2}(1 - \cos(2x))$, $\cos^2 x = \frac{1}{2}(1 + \cos(2x))$ or $\sin(2x) = 2 \sin x \cos x$ can be used.

Also note that $\int \sec^2(kx) \, dx = \frac{1}{k} \tan(kx) + c$. The identity $1 + \tan^2 x = \sec^2 x$ is used in the following example.

Example 15

Find:

a $\int \cos^2 x \, dx$

b $\int \tan^2 x \, dx$

c $\int \sin(2x) \cos(2x) \, dx$

d $\int \cos^4 x \, dx$

e $\int \sin^3 x \cos^2 x \, dx$

Solution**a** Use the identity $\cos(2x) = 2 \cos^2 x - 1$. Rearranging gives

$$\cos^2 x = \frac{1}{2}(\cos(2x) + 1)$$

$$\begin{aligned} \therefore \int \cos^2 x \, dx &= \frac{1}{2} \int \cos(2x) + 1 \, dx \\ &= \frac{1}{2} \left(\frac{1}{2} \sin(2x) + x \right) + c \\ &= \frac{1}{4} \sin(2x) + \frac{x}{2} + c \end{aligned}$$

b Use the identity $1 + \tan^2 x = \sec^2 x$. This gives $\tan^2 x = \sec^2 x - 1$ and so

$$\begin{aligned} \int \tan^2 x \, dx &= \int \sec^2 x - 1 \, dx \\ &= \tan x - x + c \end{aligned}$$

c Use the identity $\sin(2\theta) = 2 \sin \theta \cos \theta$.Let $\theta = 2x$. Then $\sin(4x) = 2 \sin(2x) \cos(2x)$ and so $\sin(2x) \cos(2x) = \frac{1}{2} \sin(4x)$.

$$\begin{aligned} \therefore \int \sin(2x) \cos(2x) \, dx &= \frac{1}{2} \int \sin(4x) \, dx \\ &= \frac{1}{2} \left(-\frac{1}{4} \cos(4x) \right) + c \\ &= -\frac{1}{8} \cos(4x) + c \end{aligned}$$

d $\cos^4 x = (\cos^2 x)^2 = \left(\frac{\cos(2x) + 1}{2} \right)^2 = \frac{1}{4}(\cos^2(2x) + 2 \cos(2x) + 1)$

As $\cos(4x) = 2 \cos^2(2x) - 1$, this gives

$$\begin{aligned} \cos^4 x &= \frac{1}{4} \left(\frac{\cos(4x) + 1}{2} + 2 \cos(2x) + 1 \right) \\ &= \frac{1}{8} \cos(4x) + \frac{1}{2} \cos(2x) + \frac{3}{8} \end{aligned}$$

$$\begin{aligned} \therefore \int \cos^4 x \, dx &= \int \frac{1}{8} \cos(4x) + \frac{1}{2} \cos(2x) + \frac{3}{8} \, dx \\ &= \frac{1}{32} \sin(4x) + \frac{1}{4} \sin(2x) + \frac{3}{8} x + c \end{aligned}$$

$$\begin{aligned} \mathbf{e} \quad \int \sin^3 x \cos^2 x \, dx &= \int \sin x (\sin^2 x) \cos^2 x \, dx \\ &= \int \sin x (1 - \cos^2 x) \cos^2 x \, dx \end{aligned}$$

Now let $u = \cos x$. Then $\frac{du}{dx} = -\sin x$. We obtain

$$\begin{aligned} \int \sin^3 x \cos^2 x \, dx &= - \int (-\sin x)(1 - u^2)(u^2) \, dx \\ &= - \int (1 - u^2) u^2 \frac{du}{dx} \, dx \\ &= - \int u^2 - u^4 \, du \\ &= - \left(\frac{u^3}{3} - \frac{u^5}{5} \right) + c \\ &= \frac{\cos^5 x}{5} - \frac{\cos^3 x}{3} + c \end{aligned}$$

Exercise 11E

Skillsheet

1 Find an antiderivative of each of the following:

a $\sin^2 x$

b $\sin^4 x$

c $2 \tan^2 x$

d $2 \sin(3x) \cos(3x)$

e $\sin^2(2x)$

f $\tan^2(2x)$

g $\sin^2 x \cos^2 x$

h $\cos^2 x - \sin^2 x$

i $\cot^2 x$

j $\cos^3(2x)$

2 Find an antiderivative of each of the following:

a $\sec^2 x$

b $\sec^2(2x)$

c $\sec^2\left(\frac{1}{2}x\right)$

d $\sec^2(kx)$

e $\tan^2(3x)$

f $1 - \tan^2 x$

g $\tan^2 x - \sec^2 x$

h $\operatorname{cosec}^2\left(x - \frac{\pi}{2}\right)$

3 Evaluate each of the following definite integrals:

a $\int_0^{\frac{\pi}{2}} \sin^2 x \, dx$

b $\int_0^{\frac{\pi}{4}} \tan^3 x \, dx$

c $\int_0^{\frac{\pi}{2}} \sin^2 x \cos x \, dx$

d $\int_0^{\frac{\pi}{4}} \cos^4 x \, dx$

e $\int_0^{\pi} \sin^3 x \, dx$

f $\int_0^{\frac{\pi}{2}} \sin^2(2x) \, dx$

g $\int_0^{\frac{\pi}{3}} \sin^2 x \cos^2 x \, dx$

h $\int_0^1 \sin^2 x + \cos^2 x \, dx$

4 Find an antiderivative of each of the following:

a $\cos^3 x$

b $\sin^3\left(\frac{x}{4}\right)$

c $\cos^2(4\pi x)$

d $7 \cos^7 t$

e $\cos^3(5x)$

f $8 \sin^4 x$

g $\sin^2 x \cos^4 x$

h $\cos^5 x$



11F Partial fractions

We studied graphs of rational functions in Chapter 10. If $g(x)$ and $h(x)$ are polynomials, then

$$f(x) = \frac{g(x)}{h(x)}$$
 is a rational function;

e.g. $f(x) = \frac{4x + 2}{x^2 - 1}$

- If the degree of $g(x)$ is less than the degree of $h(x)$, then $f(x)$ is a **proper fraction**.
- If the degree of $g(x)$ is greater than or equal to the degree of $h(x)$, then $f(x)$ is an **improper fraction**.

A rational function may be expressed as a sum of simpler functions by resolving it into what are called **partial fractions**. For example:

$$\frac{4x + 2}{x^2 - 1} = \frac{3}{x - 1} + \frac{1}{x + 1}$$

We will see that this is a useful technique for integration.

► Proper fractions

For proper fractions, the method used for obtaining partial fractions depends on the type of factors in the denominator of the original algebraic fraction. We only consider examples where the denominators have factors that are either degree 1 (linear) or degree 2 (quadratic).

- For every linear factor $ax + b$ in the denominator, there will be a partial fraction of the form $\frac{A}{ax + b}$.
- For every repeated linear factor $(cx + d)^2$ in the denominator, there will be partial fractions of the form $\frac{B}{cx + d}$ and $\frac{C}{(cx + d)^2}$.
- For every irreducible quadratic factor $ax^2 + bx + c$ in the denominator, there will be a partial fraction of the form $\frac{Dx + E}{ax^2 + bx + c}$.

Note: A quadratic expression is said to be **irreducible** if it cannot be factorised over \mathbb{R} .
For example, both $x^2 + 1$ and $x^2 + 4x + 10$ are irreducible.

To resolve an algebraic fraction into its partial fractions:

- Step 1** Write a statement of identity between the original fraction and a sum of the appropriate number of partial fractions.
- Step 2** Express the sum of the partial fractions as a single fraction, and note that the numerators of both sides are equivalent.
- Step 3** Find the values of the introduced constants A, B, C, \dots by substituting appropriate values for x or by equating coefficients.

Example 16

Resolve $\frac{3x+5}{(x-1)(x+3)}$ into partial fractions.

Solution

Let

$$\frac{3x+5}{(x-1)(x+3)} = \frac{A}{x-1} + \frac{B}{x+3} \quad (1)$$

for all $x \in \mathbb{R} \setminus \{1, -3\}$. Then

$$3x+5 = A(x+3) + B(x-1) \quad (2)$$

Substitute $x = 1$ in equation (2):

$$8 = 4A$$

$$\therefore A = 2$$

Substitute $x = -3$ in equation (2):

$$-4 = -4B$$

$$\therefore B = 1$$

$$\text{Hence } \frac{3x+5}{(x-1)(x+3)} = \frac{2}{x-1} + \frac{1}{x+3}.$$

Explanation

We know that equation (2) is true for all $x \in \mathbb{R} \setminus \{1, -3\}$.

But if this is the case, then it also has to be true for $x = 1$ and $x = -3$.

Notes:

- You could substitute any values of x to find A and B in this way, but these values simplify the calculations.
- The method of equating coefficients could also be used here.

Example 17

Resolve $\frac{2x+10}{(x+1)(x-1)^2}$ into partial fractions.

Solution

Since the denominator has a repeated linear factor and a single linear factor, there are three partial fractions:

$$\frac{2x+10}{(x+1)(x-1)^2} = \frac{A}{x+1} + \frac{B}{x-1} + \frac{C}{(x-1)^2}$$

This gives the equation

$$2x+10 = A(x-1)^2 + B(x+1)(x-1) + C(x+1)$$

$$\text{Let } x = 1: \quad 12 = 2C$$

$$\therefore C = 6$$

$$\text{Let } x = -1: \quad 8 = 4A$$

$$\therefore A = 2$$

$$\text{Let } x = 0: \quad 10 = A - B + C$$

$$\therefore B = A + C - 10 = -2$$

$$\text{Hence } \frac{2x+10}{(x+1)(x-1)^2} = \frac{2}{x+1} - \frac{2}{x-1} + \frac{6}{(x-1)^2}.$$

Example 18

Resolve $\frac{x^2 + 6x + 5}{(x - 2)(x^2 + x + 1)}$ into partial fractions.

Solution

Since the denominator has a single linear factor and an irreducible quadratic factor (i.e. cannot be reduced to linear factors), there are two partial fractions:

$$\frac{x^2 + 6x + 5}{(x - 2)(x^2 + x + 1)} = \frac{A}{x - 2} + \frac{Bx + C}{x^2 + x + 1}$$

This gives the equation

$$x^2 + 6x + 5 = A(x^2 + x + 1) + (Bx + C)(x - 2) \quad (1)$$

Substituting $x = 2$:

$$2^2 + 6(2) + 5 = A(2^2 + 2 + 1)$$

$$21 = 7A$$

$$\therefore A = 3$$

We can rewrite equation (1) as

$$\begin{aligned} x^2 + 6x + 5 &= A(x^2 + x + 1) + (Bx + C)(x - 2) \\ &= A(x^2 + x + 1) + Bx^2 - 2Bx + Cx - 2C \\ &= (A + B)x^2 + (A - 2B + C)x + A - 2C \end{aligned}$$

Since $A = 3$, this gives

$$x^2 + 6x + 5 = (3 + B)x^2 + (3 - 2B + C)x + 3 - 2C$$

Equate coefficients:

$$3 + B = 1 \quad \text{and} \quad 3 - 2C = 5$$

$$\therefore B = -2 \quad \therefore C = -1$$

Check: $3 - 2B + C = 3 - 2(-2) + (-1) = 6$

Therefore

$$\begin{aligned} \frac{x^2 + 6x + 5}{(x - 2)(x^2 + x + 1)} &= \frac{3}{x - 2} + \frac{-2x - 1}{x^2 + x + 1} \\ &= \frac{3}{x - 2} - \frac{2x + 1}{x^2 + x + 1} \end{aligned}$$

Note: The values of B and C could also be found by substituting $x = 0$ and $x = 1$ in equation (1).

► Improper fractions

Improper algebraic fractions can be expressed as a sum of partial fractions by first dividing the denominator into the numerator to produce a quotient and a proper fraction. This proper fraction can then be resolved into its partial fractions using the techniques just introduced.

Example 19

Express $\frac{x^5 + 2}{x^2 - 1}$ as partial fractions.

Solution

Dividing through:

$$\begin{array}{r} x^3 + x \\ x^2 - 1 \overline{) x^5 + 2} \\ \underline{x^5 - x^3} \\ x^3 + 2 \\ \underline{x^3 - x} \\ x + 2 \end{array}$$

Therefore

$$\frac{x^5 + 2}{x^2 - 1} = x^3 + x + \frac{x + 2}{x^2 - 1}$$

By expressing $\frac{x + 2}{x^2 - 1} = \frac{x + 2}{(x - 1)(x + 1)}$ as partial fractions, we obtain

$$\frac{x^5 + 2}{x^2 - 1} = x^3 + x - \frac{1}{2(x + 1)} + \frac{3}{2(x - 1)}$$

Using the TI-Nspire

Use **menu** > **Algebra** > **Expand** as shown.

Note: The use of ‘, x’ is optional.

The TI-Nspire calculator screen displays the command `expand((x^5+2)/(x^2-1), x)` and the result $x^3 + x - \frac{1}{2(x+1)} + \frac{3}{2(x-1)}$.

Using the Casio ClassPad

- In $\sqrt{\square}$, enter and highlight $\frac{x^5 + 2}{x^2 - 1}$.
- Go to **Interactive** > **Transformation** > **expand** and choose the **Partial Fraction** option.
- Enter the variable and tap OK.

The Casio ClassPad calculator screen shows the `expand` function being used on $\frac{x^5 + 2}{x^2 - 1}$ with variable x . The result is $x^3 + x - \frac{1}{2 \cdot (x + 1)} + \frac{3}{2 \cdot (x - 1)}$.

Summary of partial fractions

- Examples of resolving a proper fraction into partial fractions:

- Distinct linear factors

$$\frac{3x - 4}{(2x - 3)(x + 5)} = \frac{A}{2x - 3} + \frac{B}{x + 5}$$

- Repeated linear factor

$$\frac{3x - 4}{(2x - 3)(x + 5)^2} = \frac{A}{2x - 3} + \frac{B}{x + 5} + \frac{C}{(x + 5)^2}$$

- Irreducible quadratic factor

$$\frac{3x - 4}{(2x - 3)(x^2 + 5)} = \frac{A}{2x - 3} + \frac{Bx + C}{x^2 + 5}$$

- If $f(x) = \frac{g(x)}{h(x)}$ is an improper fraction, i.e. if the degree of $g(x)$ is greater than or equal to the degree of $h(x)$, then the division must be performed first.

These techniques work with more than two factors in the denominator.

- Distinct linear factors:
$$\frac{p(x)}{(x - a_1)(x - a_2) \dots (x - a_n)} = \frac{A_1}{x - a_1} + \frac{A_2}{x - a_2} + \dots + \frac{A_n}{x - a_n}$$

- Repeated linear factor:
$$\frac{p(x)}{(x - a)^n} = \frac{A_1}{(x - a)} + \frac{A_2}{(x - a)^2} + \dots + \frac{A_n}{(x - a)^n}$$

► Using partial fractions for integration

We now use partial fractions to help perform integration.

Distinct linear factors

Example 20

Find $\int \frac{3x + 5}{(x - 1)(x + 3)} dx$.

Solution

In Example 16, we found that

$$\frac{3x + 5}{(x - 1)(x + 3)} = \frac{2}{x - 1} + \frac{1}{x + 3}$$

Therefore

$$\begin{aligned} \int \frac{3x + 5}{(x - 1)(x + 3)} dx &= \int \frac{2}{x - 1} dx + \int \frac{1}{x + 3} dx \\ &= 2 \ln |x - 1| + \ln |x + 3| + c \end{aligned}$$

Using the logarithm rules:

$$\int \frac{3x + 5}{(x - 1)(x + 3)} dx = \ln((x - 1)^2 |x + 3|) + c$$

Improper fractions

If the degree of the numerator is greater than or equal to the degree of the denominator, then division must take place first.

Example 21

Find $\int \frac{x^5 + 2}{x^2 - 1} dx$.

Solution

In Example 19, we divided through to find that

$$\frac{x^5 + 2}{x^2 - 1} = x^3 + x + \frac{x + 2}{x^2 - 1}$$

Expressing as partial fractions:

$$\frac{x^5 + 2}{x^2 - 1} = x^3 + x - \frac{1}{2(x + 1)} + \frac{3}{2(x - 1)}$$

Hence

$$\begin{aligned} \int \frac{x^5 + 2}{x^2 - 1} dx &= \int x^3 + x - \frac{1}{2(x + 1)} + \frac{3}{2(x - 1)} dx \\ &= \frac{x^4}{4} + \frac{x^2}{2} - \frac{1}{2} \ln|x + 1| + \frac{3}{2} \ln|x - 1| + c \\ &= \frac{x^4}{4} + \frac{x^2}{2} + \frac{1}{2} \ln\left(\frac{|x - 1|^3}{|x + 1|}\right) + c \end{aligned}$$

Repeated linear factor

Example 22

Express $\frac{3x + 1}{(x + 2)^2}$ in partial fractions and hence find $\int \frac{3x + 1}{(x + 2)^2} dx$.

Solution

Write $\frac{3x + 1}{(x + 2)^2} = \frac{A}{x + 2} + \frac{B}{(x + 2)^2}$

Then $3x + 1 = A(x + 2) + B$

Substituting $x = -2$ gives $-5 = B$.

Substituting $x = 0$ gives $1 = 2A + B$ and therefore $A = 3$.

Thus $\frac{3x + 1}{(x + 2)^2} = \frac{3}{x + 2} - \frac{5}{(x + 2)^2}$

$$\begin{aligned} \therefore \int \frac{3x + 1}{(x + 2)^2} dx &= \int \frac{3}{x + 2} - \frac{5}{(x + 2)^2} dx \\ &= 3 \ln|x + 2| + \frac{5}{x + 2} + c \end{aligned}$$

Irreducible quadratic factor



Example 23

Find an antiderivative of $\frac{4}{(x+1)(x^2+1)}$ by first expressing it as partial fractions.

Solution

Write

$$\frac{4}{(x+1)(x^2+1)} = \frac{A}{x+1} + \frac{Bx+C}{x^2+1}$$

Then

$$4 = A(x^2+1) + (Bx+C)(x+1)$$

$$\text{Let } x = -1: \quad 4 = 2A$$

$$\therefore A = 2$$

$$\text{Let } x = 0: \quad 4 = A + C$$

$$\therefore C = 2$$

$$\text{Let } x = 1: \quad 4 = 2A + 2(B+C)$$

$$\therefore B = -2$$

Hence

$$\frac{4}{(x+1)(x^2+1)} = \frac{2}{x+1} + \frac{2-2x}{x^2+1}$$

We now turn to the integration:

$$\begin{aligned} \int \frac{4}{(x+1)(x^2+1)} dx &= \int \frac{2}{x+1} + \frac{2-2x}{x^2+1} dx \\ &= \int \frac{2}{x+1} dx + \int \frac{2}{x^2+1} dx - \int \frac{2x}{x^2+1} dx \\ &= 2 \ln|x+1| + 2 \arctan x - \ln(x^2+1) + c \\ &= \ln\left(\frac{(x+1)^2}{x^2+1}\right) + 2 \arctan x + c \end{aligned}$$

Exercise 11F

Skillsheet

1 Resolve the following rational expressions into partial fractions:

Example 16

a $\frac{5x+1}{(x-1)(x+2)}$

b $\frac{-1}{(x+1)(2x+1)}$

c $\frac{3x-2}{x^2-4}$

d $\frac{4x+7}{x^2+x-6}$

e $\frac{7-x}{(x-4)(x+1)}$

Example 17

2 Resolve the following rational expressions into partial fractions:

a $\frac{2x+3}{(x-3)^2}$

b $\frac{9}{(1+2x)(1-x)^2}$

c $\frac{2x-2}{(x+1)(x-2)^2}$

Example 18 3 Resolve the following rational expressions into partial fractions:

a $\frac{3x + 1}{(x + 1)(x^2 + x + 1)}$

b $\frac{3x^2 + 2x + 5}{(x^2 + 2)(x + 1)}$

c $\frac{x^2 + 2x - 13}{2x^3 + 6x^2 + 2x + 6}$

Example 19 4 Resolve $\frac{3x^2 - 4x - 2}{(x - 1)(x - 2)}$ into partial fractions.

Example 20 5 Decompose $\frac{9}{(x - 10)(x - 1)}$ into partial fractions and find its antiderivatives.

Example 21 6 Decompose $\frac{x^4 + 1}{(x + 2)^2}$ into partial fractions and find its antiderivatives.

Example 22 7 Decompose $\frac{7x + 1}{(x + 2)^2}$ into partial fractions and find its antiderivatives.

Example 23 8 Decompose $\frac{5}{(x^2 + 2)(x - 4)}$ into partial fractions and find its antiderivatives.

9 Decompose each of the following into partial fractions and find their antiderivatives:

a $\frac{7}{(x - 2)(x + 5)}$

b $\frac{x + 3}{x^2 - 3x + 2}$

c $\frac{2x + 1}{(x + 1)(x - 1)}$

d $\frac{2x^2}{x^2 - 1}$

e $\frac{2x + 1}{x^2 + 4x + 4}$

f $\frac{4x - 2}{(x - 2)(x + 4)}$

10 Find an antiderivative of each of the following:

a $\frac{2x - 3}{x^2 - 5x + 6}$

b $\frac{5x + 1}{(x - 1)(x + 2)}$

c $\frac{x^3 - 2x^2 - 3x + 9}{x^2 - 4}$

d $\frac{4x + 10}{x^2 + 5x + 4}$

e $\frac{x^3 + x^2 - 3x + 3}{x + 2}$

f $\frac{x^3 + 3}{x^2 - x}$

11 Find an antiderivative of each of the following:

a $\frac{3x}{(x + 1)(x^2 + 2)}$

b $\frac{2}{(x + 1)^2(x^2 + 1)}$

c $\frac{5x^3}{(x - 1)(x^2 + 4)}$

d $\frac{16(4x + 1)}{(x - 2)^2(x^2 + 4)}$

e $\frac{24(x + 2)}{(x + 2)^2(x^2 + 2)}$

f $\frac{8}{(x + 1)^3(x^2 - 1)}$

12 Evaluate the following:

a $\int_1^2 \frac{1}{x(x + 1)} dx$

b $\int_0^1 \frac{1}{(x + 1)(x + 2)} dx$

c $\int_2^3 \frac{x - 2}{(x - 1)(x + 2)} dx$

d $\int_0^1 \frac{x^2}{x^2 + 3x + 2} dx$

e $\int_2^3 \frac{x + 7}{(x + 3)(x - 1)} dx$

f $\int_2^3 \frac{2x + 6}{(x - 1)^2} dx$

g $\int_2^3 \frac{x + 2}{x(x + 4)} dx$

h $\int_0^1 \frac{1 - 4x}{3 + x - 2x^2} dx$

i $\int_1^2 \frac{1}{x(x - 4)} dx$

j $\int_{-3}^{-2} \frac{1 - 4x}{(x + 6)(x + 1)} dx$

13 Evaluate the following:

a $\int_0^1 \frac{10x}{(x+1)(x^2+1)} dx$

c $\int_0^1 \frac{x^2-1}{x^2+1} dx$

b $\int_0^{\sqrt{3}} \frac{x^3-8}{(x-2)(x^2+1)} dx$

d $\int_{-\frac{1}{2}}^0 \frac{6}{(x^2+x+1)(x-1)} dx$

14 Let $f(x) = \frac{x^2+6x+5}{(x-2)(x^2+x+1)}$.

a Express $f(x)$ as partial fractions.

c Hence evaluate $\int_{-2}^{-1} f(x) dx$.

b Hence find an antiderivative of $f(x)$.



11G Integration by parts

The product rule is

$$\frac{d}{dx}(uv) = u \frac{dv}{dx} + v \frac{du}{dx}$$

Integrate both sides with respect to x :

$$\int \frac{d}{dx}(uv) dx = \int u \frac{dv}{dx} dx + \int v \frac{du}{dx} dx$$

By rearranging this equation, we obtain the following technique for integration.

Integration by parts

$$\int u \frac{dv}{dx} dx = uv - \int v \frac{du}{dx} dx$$

Note: We can use integration by parts to find an integral $\int u \frac{dv}{dx} dx$ if the integral $\int v \frac{du}{dx} dx$ is easier to find.

Example 24

Find an antiderivative of each of the following:

a $x \cos x$

b xe^x

c $\arcsin x$

Solution

a Let $u = x$ and $\frac{dv}{dx} = \cos x$.

Then $\frac{du}{dx} = 1$ and $v = \sin x$. (Choose v to be the simplest antiderivative of $\frac{dv}{dx}$.)

$$\begin{aligned} \text{So } \int x \cos x dx &= \int u \frac{dv}{dx} dx \\ &= uv - \int v \frac{du}{dx} dx \\ &= x \sin x - \int \sin x dx \\ &= x \sin x + \cos x + c \end{aligned}$$

b $\int xe^x dx$

Let $u = x$ and $\frac{dv}{dx} = e^x$. Then $\frac{du}{dx} = 1$ and $v = e^x$.

$$\begin{aligned} \text{So } \int xe^x dx &= \int u \frac{dv}{dx} dx \\ &= uv - \int v \frac{du}{dx} dx \\ &= xe^x - \int e^x dx \\ &= xe^x - e^x + c \end{aligned}$$

c $\int \arcsin x dx$

Let $u = \arcsin x$ and $\frac{dv}{dx} = 1$. Then $\frac{du}{dx} = \frac{1}{\sqrt{1-x^2}}$ and $v = x$.

$$\begin{aligned} \text{So } \int \arcsin x dx &= \int u \frac{dv}{dx} dx \\ &= uv - \int v \frac{du}{dx} dx \\ &= x \arcsin x - \int \frac{x}{\sqrt{1-x^2}} dx \\ &= x \arcsin x + \sqrt{1-x^2} + c \end{aligned}$$

Note: We can find $\int \frac{x}{\sqrt{1-x^2}} dx$ by using the substitution $w = 1 - x^2$.

Using integration by parts more than once

In some cases, we need to use integration by parts more than once.

Example 25

Find $\int x^2 e^x dx$.

Solution

Let $u = x^2$ and $\frac{dv}{dx} = e^x$. Then $\frac{du}{dx} = 2x$ and $v = e^x$.

$$\begin{aligned} \text{So } \int x^2 e^x dx &= \int u \frac{dv}{dx} dx \\ &= uv - \int v \frac{du}{dx} dx \\ &= x^2 e^x - \int 2xe^x dx \\ &= x^2 e^x - 2(xe^x - e^x) + c \quad (\text{using Example 24b}) \\ &= (x^2 - 2x + 2)e^x + c \end{aligned}$$

Using integration by parts by solving for the unknown integral

Integration by parts can be applied to expressions of the form $e^{ax} \sin(bx)$ and $e^{ax} \cos(bx)$ in a different way. Again, we use integration by parts twice. We form an equation which we can solve for the unknown integral.

Example 26

Find $\int e^x \cos x \, dx$.

Solution

Let $u = e^x$ and $\frac{dv}{dx} = \cos x$. Then $\frac{du}{dx} = e^x$ and $v = \sin x$.

So, using integration by parts, we obtain

$$\int e^x \cos x \, dx = e^x \sin x - \int e^x \sin x \, dx \quad (1)$$

Similarly, we can use integration by parts to obtain

$$\int e^x \sin x \, dx = -e^x \cos x + \int e^x \cos x \, dx \quad (2)$$

Substitute (2) in (1) and then rearrange:

$$\int e^x \cos x \, dx = e^x \sin x - (-e^x \cos x + \int e^x \cos x \, dx)$$

$$\therefore 2 \int e^x \cos x \, dx = e^x \sin x + e^x \cos x + c$$

Now dividing by 2 and renaming the constant gives

$$\int e^x \cos x \, dx = \frac{1}{2} e^x (\sin x + \cos x) + c$$

Using integration by parts for definite integrals

We can also use integration by parts to evaluate definite integrals.

$$\int_a^b u \frac{dv}{dx} \, dx = [uv]_a^b - \int_a^b v \frac{du}{dx} \, dx$$

Example 27

Evaluate $\int_1^2 \ln x \, dx$.

Solution

Let $u = \ln x$ and $\frac{dv}{dx} = 1$. Then $\frac{du}{dx} = \frac{1}{x}$ and $v = x$.

We have

$$\begin{aligned} \int_1^2 \ln x \, dx &= [x \ln x]_1^2 - \int_1^2 1 \, dx \\ &= [x \ln x]_1^2 - [x]_1^2 \\ &= 2 \ln 2 - (2 - 1) \\ &= 2 \ln 2 - 1 \end{aligned}$$

Exercise 11G

Example 24 1 Find an antiderivative of each of the following:

- | | | | |
|-----------------------|-----------------------------------|------------------------|------------------------|
| a $x e^{-x}$ | b $\ln x$ | c $x \sin x$ | d $\arccos x$ |
| e $x \cos(3x)$ | f $x \sec^2 x$ | g $x \tan^2 x$ | h $\arcsin(2x)$ |
| i $\arctan x$ | j $(x+1)e^{-x}$ | k $x \arctan x$ | l $x \ln x$ |
| m $x^2 \ln x$ | n $x^{-\frac{1}{2}} \ln x$ | o $(x+3)e^x$ | p $x^5 \ln x$ |
| q $x e^{2x+1}$ | r $x \ln(2x)$ | | |

Example 25 2 Find an antiderivative of each of the following:

- a** $x^2 e^{-x}$ **b** $x^2 \sin x$

Example 26 3 Find an antiderivative of each of the following:

- a** $e^x \sin x$ **b** $e^{2x} \cos(3x)$ **c** $e^{3x} \sin x$ **d** $e^x \sin\left(\frac{x}{2}\right)$

Example 27 4 Evaluate each of the following:

- | | | |
|----------------------------------|--|---|
| a $\int_0^2 x e^{2x} dx$ | b $\int_0^{2\pi} x \sin(4x) dx$ | c $\int_0^{\frac{\pi}{4}} x \cos(4x) dx$ |
| d $\int_0^1 2x e^{3x} dx$ | e $\int_0^{\pi} (4x-3) \sin\left(\frac{x}{4}\right) dx$ | f $\int_0^1 x^2 e^{3x-1} dx$ |
| g $\int_1^2 \ln(3x) dx$ | h $\int_0^2 x^2 e^{2x} dx$ | i $\int_1^3 x^2 \ln x dx$ |



11H Further techniques and miscellaneous exercises

In this section, the different techniques are arranged so that a choice must be made of the most suitable one for a particular problem. Often there is more than one appropriate choice.

The relationship between a function and its derivative is also exploited. This is illustrated in the following example.

Example 28

- a** Find the derivative of $\sin^{-1}(x) + x\sqrt{1-x^2}$. **b** Hence evaluate $\int_0^{\frac{1}{2}} \sqrt{1-x^2} dx$.

Solution

a Let $y = \sin^{-1}(x) + x\sqrt{1-x^2}$. Then

$$\begin{aligned} \frac{dy}{dx} &= \frac{1}{\sqrt{1-x^2}} + \left(\sqrt{1-x^2} + \frac{(-x)x}{\sqrt{1-x^2}} \right) && \text{(using the product rule for } x\sqrt{1-x^2}\text{)} \\ &= \frac{1}{\sqrt{1-x^2}} + \frac{1-x^2-x^2}{\sqrt{1-x^2}} \\ &= \frac{2(1-x^2)}{\sqrt{1-x^2}} \\ &= 2\sqrt{1-x^2} \end{aligned}$$

b From part **a**, we have

$$\begin{aligned} \int 2\sqrt{1-x^2} dx &= \sin^{-1}(x) + x\sqrt{1-x^2} + c \\ \therefore \int_0^{\frac{1}{2}} 2\sqrt{1-x^2} dx &= \left[\sin^{-1}(x) + x\sqrt{1-x^2} \right]_0^{\frac{1}{2}} \\ \therefore \int_0^{\frac{1}{2}} \sqrt{1-x^2} dx &= \frac{1}{2} \left(\sin^{-1}\left(\frac{1}{2}\right) + \frac{1}{2}\sqrt{1-\left(\frac{1}{2}\right)^2} - (\sin^{-1}(0) + 0) \right) \\ &= \frac{1}{2} \left(\frac{\pi}{6} + \frac{1}{2} \cdot \frac{\sqrt{3}}{2} \right) \\ &= \frac{\pi}{12} + \frac{\sqrt{3}}{8} \end{aligned}$$

Exercise 11H

Skillsheet

- 1** If $\int_0^1 \frac{1}{(x+1)(x+2)} dx = \ln p$, find p .
- 2** Evaluate $\int_0^{\frac{\pi}{6}} \sin^2 x \cos x dx$.
- 3** Evaluate $\int_0^1 \frac{e^{2x}}{1+e^x} dx$.
- 4** Evaluate $\int_0^{\frac{\pi}{3}} \sin^3 x \cos x dx$.
- 5** Evaluate $\int_3^4 \frac{x}{(x-2)(x+1)} dx$.
- 6** Find c if $\int_0^{\frac{\pi}{6}} \frac{\cos x}{1+\sin x} dx = \ln c$.
- 7** Find an antiderivative of $\sin(3x)\cos^5(3x)$.
- 8** If $\int_4^6 \frac{2}{x^2-4} dx = \ln p$, find p .
- 9** If $\int_5^6 \frac{3}{x^2-5x+4} dx = \ln p$, find p .
- 10** Find an antiderivative of each of the following:

a $\frac{\cos x}{\sin^3 x}$	b $x(4x^2+1)^{\frac{3}{2}}$	c $\sin^2 x \cos^3 x$	d $\frac{e^x}{e^{2x}-2e^x+1}$
------------------------------------	------------------------------------	------------------------------	--------------------------------------
- 11** Evaluate $\int_0^3 \frac{x}{\sqrt{25-x^2}} dx$.
- 12** Find an antiderivative of each of the following:

a $\frac{1}{(x+1)^2+4}$	b $\frac{1}{\sqrt{1-9x^2}}$	c $\frac{1}{\sqrt{1-4x^2}}$	d $\frac{1}{(2x+1)^2+9}$
--------------------------------	------------------------------------	------------------------------------	---------------------------------

Example 28 **13** Let $f: (1, \infty) \rightarrow \mathbb{R}$, where $f(x) = \sin^{-1}\left(\frac{1}{\sqrt{x}}\right)$.

a Find $f'(x)$

b Using the result of **a**, find $\int_2^4 \frac{1}{x\sqrt{x-1}} dx$.

14 For each of the following, use an appropriate substitution to find an expression for the antiderivative in terms of $f(x)$:

a $\int f'(x)(f(x))^2 dx$

b $\int \frac{f'(x)}{(f(x))^2} dx$

c $\int \frac{f'(x)}{f(x)} dx$, where $f(x) > 0$

d $\int f'(x) \sin(f(x)) dx$

15 If $y = x\sqrt{4-x}$, find $\frac{dy}{dx}$ and simplify. Hence evaluate $\int_0^2 \frac{8-3x}{\sqrt{4-x}} dx$.

16 Find a , b and c such that $\frac{2x^3 - 11x^2 + 20x - 13}{(x-2)^2} = ax + b + \frac{c}{(x-2)^2}$ for all $x \neq 2$.

Hence find $\int \frac{2x^3 - 11x^2 + 20x - 13}{(x-2)^2} dx$.

17 Evaluate each of the following:

a $\int_0^{\frac{\pi}{4}} \sin^2(2x) dx$

b $\int_{-1}^0 (14-2x)\sqrt{x^2-14x+1} dx$

c $9 \int_{-\frac{\pi}{3}}^{\frac{\pi}{3}} \frac{\sin x}{\sqrt{\cos x}} dx$

d $\int_e^{e^2} \frac{1}{x \ln x} dx$

e $\int_0^{\frac{\pi}{4}} \tan^2 x dx$

f $\int_0^{\frac{\pi}{2}} \frac{\sin x}{2 + \cos x} dx$

18 Find $\int \sin x \cos x dx$ using:

a the substitution $u = \sin x$

b the identity $\sin(2x) = 2 \sin x \cos x$

19 a If $y = \ln(x + \sqrt{x^2 + 1})$, find $\frac{dy}{dx}$. Hence find $\int \frac{1}{\sqrt{x^2 + 1}} dx$.

b If $y = \ln(x + \sqrt{x^2 - 1})$, find $\frac{dy}{dx}$. Hence show that $\int_2^7 \frac{1}{\sqrt{x^2 - 1}} dx = \ln(2 + \sqrt{3})$.

20 Find an antiderivative of each of the following:

a $\frac{1}{4+x^2}$

b $\frac{1}{4-x^2}$

c $\frac{4+x^2}{x}$

d $\frac{x}{4+x^2}$

e $\frac{x^2}{4+x^2}$

f $\frac{1}{1+4x^2}$

g $x\sqrt{4+x^2}$

h $x\sqrt{4+x}$

i $\frac{1}{\sqrt{4-x}}$

j $\frac{1}{\sqrt{4-x^2}}$

k $\frac{x}{\sqrt{4-x}}$

l $\frac{x}{\sqrt{4-x^2}}$

21 Evaluate each of the following definite integrals:

a $\int_1^2 x e^{2x} dx$

b $\int_1^e x \ln x dx$

c $\int_0^\pi (x - \pi) \sin x dx$

22 Find constants c and d such that $\int_2^3 \frac{x^3 - x + 2}{x^2 - 1} dx = c + \ln d$.

23 a Differentiate $f(x) = \sin(x) \cos^{n-1}(x)$.

b Hence verify that $n \int \cos^n x dx = \sin(x) \cos^{n-1}(x) + (n-1) \int \cos^{n-2}(x) dx$.

c Hence evaluate:

i $\int_0^{\frac{\pi}{2}} \cos^4 x dx$

ii $\int_0^{\frac{\pi}{2}} \cos^6 x dx$

iii $\int_0^{\frac{\pi}{2}} \cos^4 x \sin^2 x dx$

iv $\int_0^{\frac{\pi}{4}} \sec^4(x) dx$

24 Find:

a $\int \frac{x}{(x+1)^n} dx$

b $\int_1^2 x(x-1)^n dx$

25 a Evaluate $\int_0^1 (1+ax)^2 dx$.

b For what value of a is the value of this integral a minimum?

26 a Differentiate $\frac{a \sin x - b \cos x}{a \sin x + b \cos x}$ with respect to x .

b Hence evaluate $\int_0^{\frac{\pi}{2}} \frac{1}{(a \cos x + b \sin x)^2} dx$.

27 Let $U_n = \int_0^{\frac{\pi}{4}} \tan^n x dx$, where $n \in \mathbb{Z}$ with $n > 1$.

a Express $U_n + U_{n-2}$ in terms of n .

b Hence show that $U_6 = \frac{13}{15} - \frac{\pi}{4}$.

28 a Simplify $\frac{1}{1 + \tan x} + \frac{1}{1 + \cot x}$.

b Let $\varphi = \frac{\pi}{2} - \theta$. Show that $\int_0^{\frac{\pi}{2}} \frac{1}{1 + \tan \theta} d\theta = \int_0^{\frac{\pi}{2}} \frac{1}{1 + \cot \varphi} d\varphi$.

c Use these results to evaluate $\int_0^{\frac{\pi}{2}} \frac{1}{1 + \tan \theta} d\theta$.



Chapter summary



Inverse circular functions

$$\int \frac{1}{\sqrt{a^2 - x^2}} dx = \sin^{-1}\left(\frac{x}{a}\right) + c$$

$$\int \frac{-1}{\sqrt{a^2 - x^2}} dx = \cos^{-1}\left(\frac{x}{a}\right) + c$$

$$\int \frac{a}{a^2 + x^2} dx = \tan^{-1}\left(\frac{x}{a}\right) + c$$

Integration by substitution

- The change of variable rule is

$$\int f(u) \frac{du}{dx} dx = \int f(u) du \quad \text{where } u \text{ is a function of } x$$

- Linear substitution

A linear substitution can be used to find antiderivatives of expressions such as

$$(2x + 3)\sqrt{3x - 4}, \quad \frac{2x + 5}{\sqrt{3x - 4}} \quad \text{and} \quad \frac{2x + 5}{(x + 2)^2}$$

Consider $\int f(x)g(ax + b) dx$.

Let $u = ax + b$. Then $x = \frac{u - b}{a}$ and so

$$\begin{aligned} \int f(x)g(ax + b) dx &= \int f\left(\frac{u - b}{a}\right)g(u) dx \\ &= \frac{1}{a} \int f\left(\frac{u - b}{a}\right)g(u) du \end{aligned}$$

- Definite integration involving the change of variable rule:

Let $u = g(x)$. Then

$$\int_a^b f(u) \frac{du}{dx} dx = \int_{g(a)}^{g(b)} f(u) du$$

Trigonometric identities

$$\sin(2x) = 2 \sin x \cos x$$

$$\cos(2x) = 2 \cos^2 x - 1$$

$$= 1 - 2 \sin^2 x$$

$$= \cos^2 x - \sin^2 x$$

$$\sec^2 x = 1 + \tan^2 x$$

Integration by parts

$$\int u \frac{dv}{dx} dx = uv - \int v \frac{du}{dx} dx$$

$$\int_a^b u \frac{dv}{dx} dx = [uv]_a^b - \int_a^b v \frac{du}{dx} dx$$

Partial fractions

- A rational function may be expressed as a sum of simpler functions by resolving it into **partial fractions**.

- Examples of resolving a proper fraction into partial fractions:

- **Distinct linear factors**

$$\frac{3x - 4}{(2x - 3)(x + 5)} = \frac{A}{2x - 3} + \frac{B}{x + 5}$$

- **Repeated linear factor**

$$\frac{3x - 4}{(2x - 3)(x + 5)^2} = \frac{A}{2x - 3} + \frac{B}{x + 5} + \frac{C}{(x + 5)^2}$$

- **Irreducible quadratic factor**

$$\frac{3x - 4}{(2x - 3)(x^2 + 5)} = \frac{A}{2x - 3} + \frac{Bx + C}{x^2 + 5}$$

- A quadratic polynomial is **irreducible** if it cannot be factorised over \mathbb{R} .
- If $f(x) = \frac{g(x)}{h(x)}$ is an improper fraction, i.e. if the degree of $g(x)$ is greater than or equal to the degree of $h(x)$, then the division must be performed first. Write $f(x)$ in the form

$$\frac{g(x)}{h(x)} = q(x) + \frac{r(x)}{h(x)}$$

where the degree of $r(x)$ is less than the degree of $h(x)$.

Short-answer questions

- 1 Find an antiderivative of each of the following:

a $\cos^3(2x)$

b $\frac{2x + 3}{4x^2 + 1}$

c $\frac{1}{1 - 4x^2}$

d $\frac{x}{\sqrt{1 - 4x^2}}$

e $\frac{x^2}{1 - 4x^2}$

f $x\sqrt{1 - 2x^2}$

g $\sin^2\left(x - \frac{\pi}{3}\right)$

h $\frac{x}{\sqrt{x^2 - 2}}$

i $\sin^2(3x)$

j $\sin^3(2x)$

k $x\sqrt{x + 1}$

l $\frac{1}{1 + \cos(2x)}$

m $\frac{e^{3x} + 1}{e^{3x+1}}$

n $\frac{x}{x^2 - 1}$

o $\sin^2 x \cos^2 x$

p $\frac{x^2}{1 + x}$

- 2 Evaluate each of the following integrals:

a $\int_0^{\frac{1}{2}} x(1 - x^2)^{\frac{1}{2}} dx$

b $\int_0^{\frac{1}{2}} (1 - x^2)^{-1} dx$

c $\int_0^{\frac{1}{2}} x(1 + x^2)^{\frac{1}{2}} dx$

d $\int_1^2 \frac{1}{6x + x^2} dx$

e $\int_0^1 \frac{2x^2 + 3x + 2}{x^2 + 3x + 2} dx$

f $\int_0^1 \frac{1}{\sqrt{4 - 3x}} dx$

g $\int_0^1 \frac{1}{\sqrt{4 - x^2}} dx$

h $\int_0^{\frac{\pi}{2}} \sin^2(2x) dx$

i $\int_{-\pi}^{\pi} \sin^2 x \cos^2 x dx$

j $\int_0^{\frac{\pi}{2}} \sin^2(2x) \cos^2(2x) dx$

k $\int_0^{\frac{\pi}{4}} \frac{2 \cos x - \sin x}{2 \sin x + \cos x} dx$

l $\int_{-1}^2 x^2 \sqrt{x^3 + 1} dx$

3 Show that $\frac{x}{x^2 + 2x + 3} = \frac{1}{2} \left(\frac{2x + 2}{x^2 + 2x + 3} \right) - \frac{1}{x^2 + 2x + 3}$. Hence find $\int \frac{x}{x^2 + 2x + 3} dx$.

4 a Differentiate $\sin^{-1}(\sqrt{x})$ and hence find $\int \frac{1}{\sqrt{x(1-x)}} dx$.

b Differentiate $\sin^{-1}(x^2)$ and hence find $\int \frac{2x}{\sqrt{1-x^4}} dx$.

5 a Find $\frac{d}{dx}(x \sin^{-1} x)$ and hence find $\int \sin^{-1} x dx$.

b Find $\frac{d}{dx}(x \ln x)$ and hence find $\int \ln x dx$.

c Find $\frac{d}{dx}(x \tan^{-1} x)$ and hence find $\int \tan^{-1} x dx$.

6 Find an antiderivative of each of the following:

a $\sin(2x) \cos(2x)$

b $x^2(x^3 + 1)^2$

c $\frac{\cos \theta}{(3 + 2 \sin \theta)^2}$

d xe^{1-x^2}

e $\tan^2(x + 3)$

f $\frac{2x}{\sqrt{6 + 2x^2}}$

g $\tan^2 x \sec^2 x$

h $\sec^3 x \tan x$

i $\tan^2(3x)$

7 Evaluate the following:

a $\int_0^{\frac{\pi}{2}} \sin^5 x dx$

b $\int_1^8 (13 - 5x)^{\frac{1}{3}} dx$

c $\int_0^{\frac{\pi}{8}} \sec^2(2x) dx$

d $\int_1^2 (3 - y)^{\frac{1}{2}} dy$

e $\int_0^{\pi} \sin^2 x dx$

f $\int_{-3}^{-1} \frac{x^2 + 1}{x^3 + 3x} dx$

8 Find the derivative of $\left(x^2 + \frac{1}{x}\right)^{\frac{1}{2}}$ and hence evaluate $\int_{-1}^2 (2x - x^{-2}) \left(x^2 + \frac{1}{x}\right)^{-\frac{1}{2}} dx$.

9 Let $f(x) = \frac{4x^2 + 16x}{(x-2)^2(x^2+4)}$.

a Given that $f(x) = \frac{a}{x-2} + \frac{6}{(x-2)^2} - \frac{bx+4}{x^2+4}$, find a and b .

b Given that $\int_{-2}^0 f(x) dx = \frac{c - \pi - \ln d}{2}$, find c and d .

10 Find an antiderivative of each of the following:

a $e^{-2x} \cos(2x + 3)$

b $x \sec^2 x$

c $e^{3x} \cos\left(\frac{x}{2}\right)$

11 Evaluate each of the following definite integrals:

a $\int_1^2 x^2 \ln x dx$

b $\int_1^2 \frac{\ln x}{x} dx$

c $\int_0^1 xe^{-2x} dx$



Multiple-choice questions



- 1 An antiderivative of $x\sqrt{4-x}$ is
A $(4-x)^{\frac{1}{2}} - \frac{x}{2}(4-x)^{-\frac{1}{2}}$ **B** $\frac{2x}{3}(4-x)^{\frac{3}{2}}$ **C** $\frac{x^2}{3}(4-x)^{\frac{3}{2}}$
D $\frac{8}{3}(4-x)^{\frac{3}{2}} - \frac{2}{5}(4-x)^{\frac{5}{2}}$ **E** $\frac{2}{5}(4-x)^{\frac{5}{2}} - \frac{8}{3}(4-x)^{\frac{3}{2}}$
- 2 If $\int_0^m \tan x \sec^2 x \, dx = \frac{3}{2}$, where $m \in (0, \frac{\pi}{2})$, then the value of m is
A 0.5 **B** 1 **C** $\frac{\pi}{3}$ **D** $\frac{\pi}{6}$ **E** $\frac{\pi}{8}$
- 3 An antiderivative of $\tan(2x)$ is
A $\frac{1}{2} \sec^2(2x)$ **B** $\frac{1}{2} \ln(\cos(2x))$ **C** $\frac{1}{2} \ln(\sec(2x))$
D $\frac{1}{2} \ln(\sin(2x))$ **E** $\frac{1}{2} \tan^2(2x)$
- 4 $\int_{\frac{\pi}{4}}^{\frac{\pi}{2}} \frac{\sin(2x)}{2 + \cos(2x)} \, dx$ is equal to
A $\frac{1}{\sqrt{2}}$ **B** $\ln\left(\frac{1}{\sqrt{2}}\right)$ **C** $\ln 2$ **D** $\frac{1}{2} \ln 2$ **E** 1
- 5 $\int_0^{\frac{\pi}{3}} \sin x \cos^3 x \, dx$ written as an integral with respect to u , where $u = \cos x$, is
A $\int_{\frac{1}{2}}^1 u^3 \, du$ **B** $\int_0^{\frac{\pi}{3}} u^3 \, du$ **C** $\int_1^{\frac{1}{2}} u^3 \sqrt{1-u^2} \, du$
D $\int_{\frac{1}{2}}^0 u^3 \sqrt{1-u^2} \, du$ **E** $\int_1^{\frac{1}{2}} u^3 \, du$
- 6 An antiderivative of $\frac{2}{\sqrt{1-16x^2}}$ is
A $\sin^{-1}\left(\frac{x}{4}\right)$ **B** $\frac{1}{2} \sin^{-1}\left(\frac{x}{4}\right)$ **C** $\sin^{-1}(4x)$ **D** $\frac{1}{2} \sin^{-1}(4x)$ **E** $\frac{1}{8} \sin^{-1}(4x)$
- 7 An antiderivative of $\frac{1}{9+4x^2}$ is
A $\frac{1}{9} \tan^{-1}\left(\frac{2x}{9}\right)$ **B** $\frac{1}{3} \tan^{-1}\left(\frac{2x}{3}\right)$ **C** $\frac{1}{6} \tan^{-1}\left(\frac{2x}{3}\right)$ **D** $9 \tan^{-1}\left(\frac{2x}{9}\right)$ **E** $\frac{3}{2} \tan^{-1}\left(\frac{2x}{3}\right)$
- 8 If $\frac{d}{dx}(xf(x)) = xf'(x) + f(x)$ and $xf'(x) = \frac{1}{1+x^2}$, then an antiderivative of $f(x)$ is
A $xf(x) - \tan^{-1}(x)$ **B** $\ln(x^2 + 1)$ **C** $\frac{1}{2x} \ln(x^2 + 1)$
D $f(x) - \tan^{-1}(x)$ **E** $\tan^{-1}(x)$
- 9 If $F'(x) = f(x)$, then an antiderivative of $3f(3-2x)$ is
A $\frac{3}{2}F(3-2x)$ **B** $-\frac{3}{4}(3-2x)^2$ **C** $\frac{3}{4}(3-2x)^2$
D $-\frac{3}{2}F(3-2x)$ **E** $-\frac{3}{2}f(3-2x)$



12

Applications of integration

Objectives

- ▶ To determine the **area** under a curve.
- ▶ To determine the **area** between two curves.
- ▶ To use a CAS calculator to evaluate definite integrals.
- ▶ To determine the **volume** of a solid of revolution.
- ▶ To apply the **exponential probability distribution**.

In this chapter we revisit the **fundamental theorem of calculus**. We will apply the theorem to the new functions introduced in this course, and use the integration techniques developed in the previous chapter.

We then study two further applications of integration.

Volume of a solid of revolution

The first application is finding the volume of a solid formed by revolving a bounded region defined by a curve around one of the axes.

If the region bounded by the curve with equation $y = f(x)$ and the lines $x = a$ and $x = b$ is rotated about the x -axis, then the volume V of the solid is given by

$$V = \pi \int_a^b (f(x))^2 dx$$

You will see how to derive the formula for the volume of a sphere, which you have used for several years.

Exponential probability distribution

The second application is to probability. We will use integration to investigate the exponential probability distribution, which is often used to model the time between the occurrence of random events.

12A The fundamental theorem of calculus



In this section we review integration from Mathematical Methods Year 12. We consider the graphs of some of the functions introduced in earlier chapters, and the areas of regions defined through these functions. It may be desirable to use a graphing package or a CAS calculator to help with the graphing in this section.

Signed area

Consider the graph of $y = x + 1$ shown to the right.

$$A_1 = \frac{1}{2} \times 3 \times 3 = 4\frac{1}{2} \quad (\text{area of a triangle})$$

$$A_2 = \frac{1}{2} \times 1 \times 1 = \frac{1}{2}$$

The total area is $A_1 + A_2 = 5$.

The **signed area** is $A_1 - A_2 = 4$.

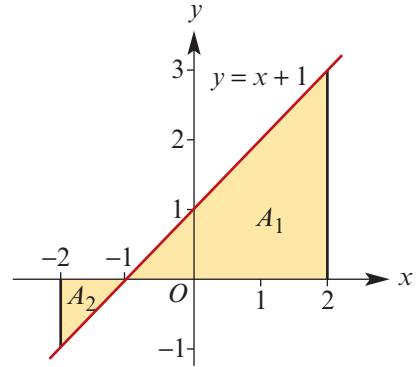

Regions above the x -axis have **positive signed area**.

Regions below the x -axis have **negative signed area**.

The total area of the shaded region is $A_1 + A_2 + A_3 + A_4$.

The signed area of the shaded region is $A_1 - A_2 + A_3 - A_4$.

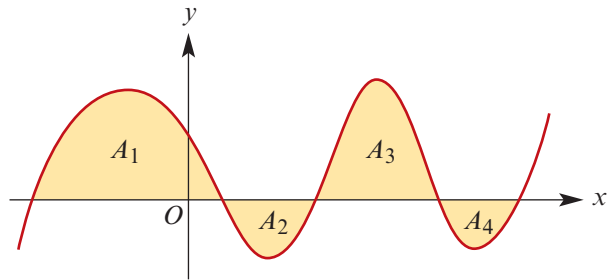

The definite integral

Let f be a continuous function on a closed interval $[a, b]$. The signed area enclosed by the graph of $y = f(x)$ between $x = a$ and $x = b$ is denoted by

$$\int_a^b f(x) dx$$

and is called the **definite integral** of $f(x)$ from $x = a$ to $x = b$.

Fundamental theorem of calculus

If f is a continuous function on an interval $[a, b]$, then

$$\int_a^b f(x) dx = F(b) - F(a)$$

where F is any antiderivative of f .

Notes:

- If $f(x) \geq 0$ for all $x \in [a, b]$, the area between $x = a$ and $x = b$ is given by $\int_a^b f(x) dx$.
- If $f(x) \leq 0$ for all $x \in [a, b]$, the area between $x = a$ and $x = b$ is given by $-\int_a^b f(x) dx$.

Example 1

The graph of $y = \frac{1}{\sqrt{4-x^2}}$ is shown.

Find the area of the shaded region.

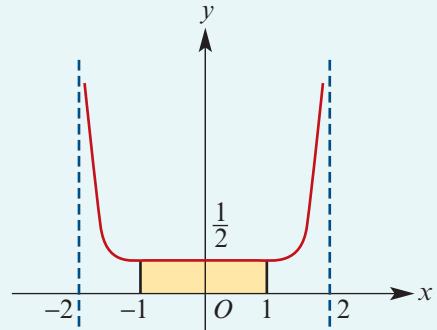
**Solution**

$$\begin{aligned}
 \text{Area} &= \int_{-1}^1 \frac{1}{\sqrt{4-x^2}} dx \\
 &= 2 \int_0^1 \frac{1}{\sqrt{4-x^2}} dx \quad (\text{by symmetry}) \\
 &= 2 \left[\sin^{-1}\left(\frac{x}{2}\right) \right]_0^1 \\
 &= 2 \sin^{-1}\left(\frac{1}{2}\right) \\
 &= 2 \times \frac{\pi}{6} \\
 &= \frac{\pi}{3}
 \end{aligned}$$

Example 2

Find the area under the graph of $y = \frac{6}{4+x^2}$ between $x = -2$ and $x = 2$.

Solution

$$\begin{aligned}
 \text{Area} &= 6 \int_{-2}^2 \frac{1}{4+x^2} dx \\
 &= \frac{6}{2} \int_{-2}^2 \frac{2}{4+x^2} dx \\
 &= 6 \int_0^2 \frac{2}{4+x^2} dx \quad (\text{by symmetry}) \\
 &= 6 \left[\tan^{-1}\left(\frac{x}{2}\right) \right]_0^2 \\
 &= 6 \tan^{-1}(1) \\
 &= 6 \times \frac{\pi}{4} \\
 &= \frac{3\pi}{2}
 \end{aligned}$$

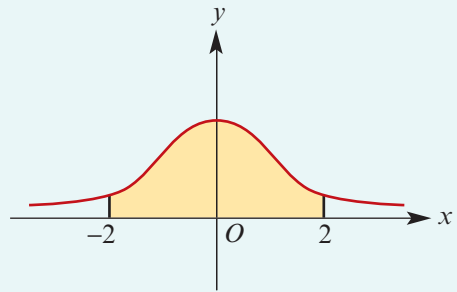

Example 3

Sketch the graph of $f: [-\frac{1}{2}, \frac{1}{2}] \rightarrow \mathbb{R}$, $f(x) = \sin^{-1}(2x)$. Shade the region defined by the inequalities $0 \leq x \leq \frac{1}{2}$ and $0 \leq y \leq f(x)$. Find the area of this region.

Solution

$$\text{Area} = \int_0^{\frac{1}{2}} \sin^{-1}(2x) \, dx$$

Note: This definite integral can be evaluated using integration by parts. Here we use a simpler method to find the area.

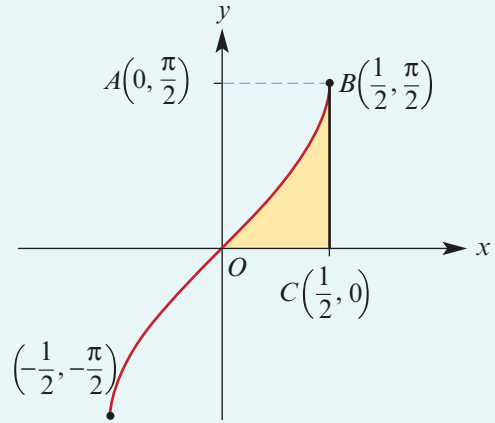

$$\begin{aligned} \text{Area} &= \text{area rectangle } OABC - \int_0^{\frac{\pi}{2}} \frac{1}{2} \sin y \, dy \\ &= \frac{\pi}{4} - \frac{1}{2} [-\cos y]_0^{\frac{\pi}{2}} \\ &= \frac{\pi}{4} - \frac{1}{2} \end{aligned}$$

Example 4

Sketch the graph of $y = \frac{1}{4-x^2}$. Shade the region for the area determined by $\int_{-1}^1 \frac{1}{4-x^2} \, dx$ and find this area.

Solution

$$\begin{aligned} \text{Area} &= \int_{-1}^1 \frac{1}{4-x^2} \, dx \\ &= \frac{1}{4} \int_{-1}^1 \frac{1}{2-x} + \frac{1}{2+x} \, dx \end{aligned}$$

By symmetry:

$$\begin{aligned} \text{Area} &= \frac{1}{2} \int_0^1 \frac{1}{2-x} + \frac{1}{2+x} \, dx \\ &= \frac{1}{2} \left[\ln \left(\frac{2+x}{2-x} \right) \right]_0^1 \\ &= \frac{1}{2} (\ln 3 - \ln 1) \\ &= \frac{1}{2} \ln 3 \end{aligned}$$

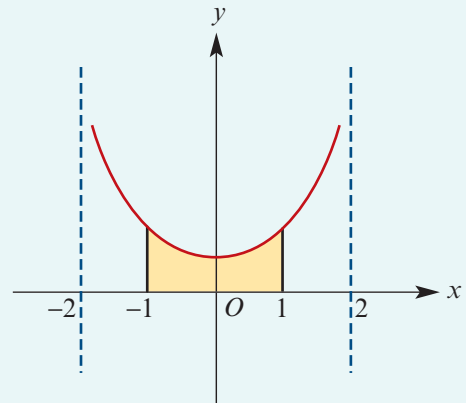

Example 5

The graph of $y = \cos^3 x$ is shown.

Find the area of the shaded region.

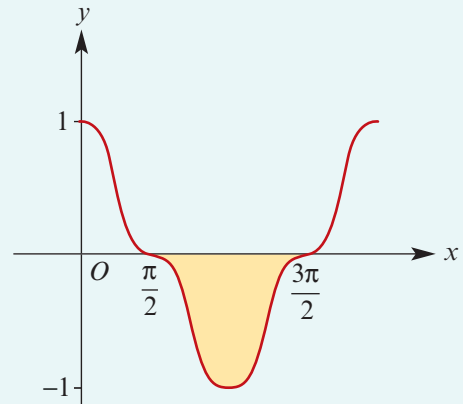
**Solution**

$$\begin{aligned} \text{Area} &= - \int_{\frac{\pi}{2}}^{\frac{3\pi}{2}} \cos^3 x \, dx \\ &= - \int_{\frac{\pi}{2}}^{\frac{3\pi}{2}} \cos x \cos^2 x \, dx \\ &= - \int_{\frac{\pi}{2}}^{\frac{3\pi}{2}} \cos x (1 - \sin^2 x) \, dx \end{aligned}$$

Let $u = \sin x$. Then $\frac{du}{dx} = \cos x$.

When $x = \frac{\pi}{2}$, $u = 1$. When $x = \frac{3\pi}{2}$, $u = -1$.

$$\begin{aligned} \therefore \text{Area} &= - \int_1^{-1} (1 - u^2) \, du \\ &= - \left[u - \frac{u^3}{3} \right]_1^{-1} \\ &= - \left(-1 + \frac{1}{3} - \left(1 - \frac{1}{3} \right) \right) \\ &= \frac{4}{3} \end{aligned}$$

Properties of the definite integral

- $\int_a^b f(x) \, dx = \int_a^c f(x) \, dx + \int_c^b f(x) \, dx$
- $\int_a^a f(x) \, dx = 0$
- $\int_a^b k f(x) \, dx = k \int_a^b f(x) \, dx$
- $\int_a^b f(x) \pm g(x) \, dx = \int_a^b f(x) \, dx \pm \int_a^b g(x) \, dx$
- $\int_a^b f(x) \, dx = - \int_b^a f(x) \, dx$

Exercise 12A

Example 1 1 Sketch the graph of $f: \left(-\frac{3}{2}, \frac{3}{2}\right) \rightarrow \mathbb{R}$, $f(x) = \frac{1}{\sqrt{9-4x^2}}$.

Find the area of the region defined by the inequalities $0 \leq y \leq f(x)$ and $-1 \leq x \leq 1$.

Example 2 2 Sketch the graph of $f: \mathbb{R} \rightarrow \mathbb{R}$, $f(x) = \frac{9}{4+x^2}$.

Find the area of the region defined by the inequalities $0 \leq y \leq f(x)$ and $-2 \leq x \leq 2$.

3 The graph of $f(x) = x + \frac{1}{x^2}$ is as shown.

Find the area of the shaded region.

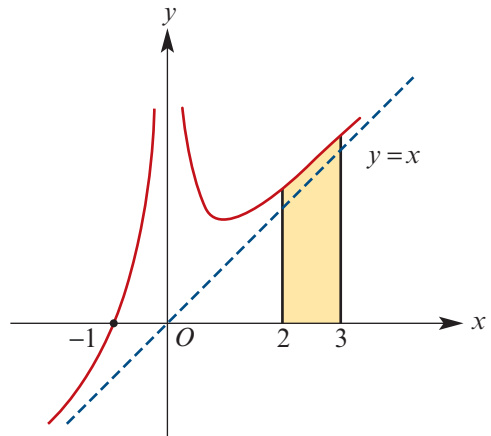

4 Sketch the graph of $f(x) = x + \frac{2}{x}$. Shade the region for which the area is determined by the integral $\int_1^2 f(x) dx$ and evaluate this integral.

Example 3 5 For each of the following:

i sketch the appropriate graph and shade the required region

ii evaluate the integral.

a $\int_0^1 \tan^{-1} x dx$ **b** $\int_0^{\frac{1}{2}} \cos^{-1}(2x) dx$ **c** $\int_{-\frac{1}{2}}^{\frac{1}{2}} \cos^{-1}(2x) dx$

d $\int_0^1 2 \sin^{-1} x dx$ **e** $\int_0^2 \sin^{-1}\left(\frac{x}{2}\right) dx$ **f** $\int_{-1}^2 \sin^{-1}\left(\frac{x}{2}\right) dx$

Example 4 6 Sketch the graph of $g: \mathbb{R} \setminus \{-3, 3\} \rightarrow \mathbb{R}$, $g(x) = \frac{4}{9-x^2}$ and find the area of the region with $-2 \leq x \leq 2$ and $0 \leq y \leq g(x)$.

7 For the curve with equation $y = -1 + \frac{2}{x^2+1}$, find:

a the coordinates of its turning point **b** the equation of its asymptote

c the area enclosed by the curve and the x -axis.

8 Consider the graph of $y = x - \frac{4}{x+3}$.

a Find the coordinates of the intercepts with the axes.

b Find the equations of all asymptotes. **c** Sketch the graph.

d Find the area bounded by the curve, the x -axis and the line $x = 8$.

- 9 a** State the implied domain of the function g with rule $g(x) = \frac{1}{(1-x)(x-2)}$.
- b** Sketch the graph of $y = g(x)$, indicating the equation of any asymptotes and the coordinates of the turning points.
- c** State the range of g .
- d** Find the area of the region bounded by the graph of $y = g(x)$, the x -axis and the lines $x = 4$ and $x = 3$.
- 10** Sketch the graph of $f: (-1, 1) \rightarrow \mathbb{R}$, $f(x) = \frac{-3}{\sqrt{1-x^2}}$. Evaluate $\int_0^{\frac{1}{2}} \frac{-3}{\sqrt{1-x^2}} dx$.
- 11** Find the area of the region enclosed by the curve $y = \frac{1}{\sqrt{4-x^2}}$, the x -axis and the lines $x = 1$ and $x = \sqrt{2}$.
- 12** Sketch the curve with equation $y = \tan^{-1} x$. Find the area enclosed between this curve, the line $x = \sqrt{3}$ and the x -axis.
- 13** Find the area between the curve $y = \frac{2 \ln x}{x}$ and the x -axis from $x = 1$ to $x = e$.

Example 5 **14** The graph of $y = \sin^3(2x)$ for $x \in [0, \pi]$ is as shown. Find the area of the shaded region.

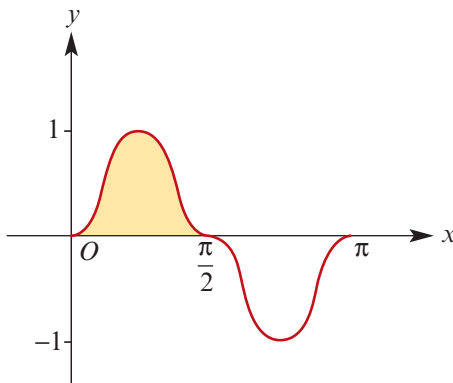

15 The graph of $y = \sin x \cos^2 x$ for $x \in [0, \pi]$ is as shown. Find the area of the shaded region.

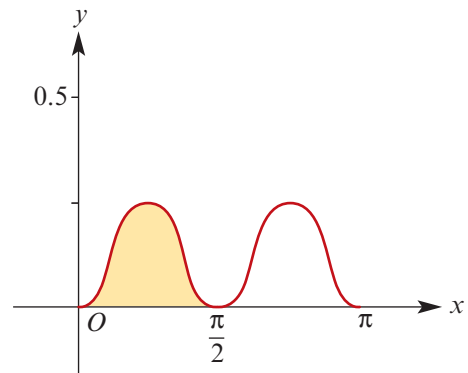

- 16** Sketch the curve with equation $y = \frac{2x}{x+3}$, showing clearly how the curve approaches its asymptotes. On your diagram, shade the finite region bounded by the curve and the lines $x = 0$, $x = 3$ and $y = 2$. Find the area of this region.
- 17 a** Show that the curve $y = \frac{3}{(2x+1)(1-x)}$ has only one turning point.
- b** Find the coordinates of this point and determine its nature.
- c** Sketch the curve.
- d** Find the area of the region enclosed by the curve and the line $y = 3$.



12B Area of a region between two curves

Let f and g be continuous functions on the interval $[a, b]$ such that

$$f(x) \geq g(x) \quad \text{for all } x \in [a, b]$$

Then the area of the region bounded by the two curves and the lines $x = a$ and $x = b$ can be found by evaluating

$$\int_a^b f(x) dx - \int_a^b g(x) dx = \int_a^b f(x) - g(x) dx$$

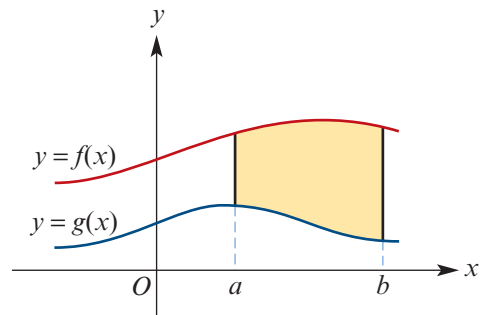

Example 6

Find the area of the region bounded by the parabola $y = x^2$ and the line $y = 2x$.

Solution

We first find the coordinates of the point P :

$$x^2 = 2x$$

$$x(x - 2) = 0$$

$$\therefore x = 0 \text{ or } x = 2$$

Therefore the coordinates of P are $(2, 4)$.

$$\begin{aligned} \text{Required area} &= \int_0^2 2x - x^2 dx \\ &= \left[x^2 - \frac{x^3}{3} \right]_0^2 \\ &= 4 - \frac{8}{3} = \frac{4}{3} \end{aligned}$$

The area is $\frac{4}{3}$ square units.

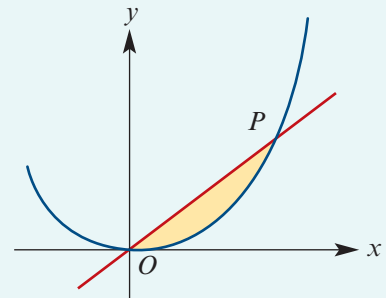

Example 7

Calculate the area of the region enclosed by the curves with equations $y = x^2 + 1$ and $y = 4 - x^2$ and the lines $x = -1$ and $x = 1$.

Solution

$$\begin{aligned} \text{Required area} &= \int_{-1}^1 4 - x^2 - (x^2 + 1) dx \\ &= \int_{-1}^1 3 - 2x^2 dx \\ &= \left[3x - \frac{2x^3}{3} \right]_{-1}^1 \\ &= 3 - \frac{2}{3} - \left(-3 + \frac{2}{3} \right) \\ &= \frac{14}{3} \end{aligned}$$

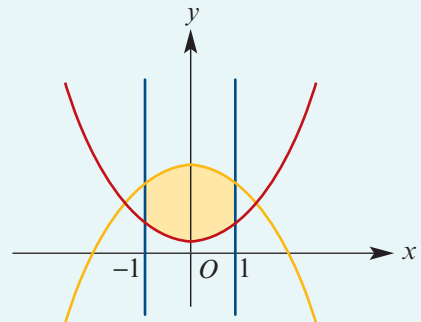

In the two examples considered so far in this section, the graph of one function is 'above' the graph of the other for all of the interval considered.

What happens when the graphs cross?

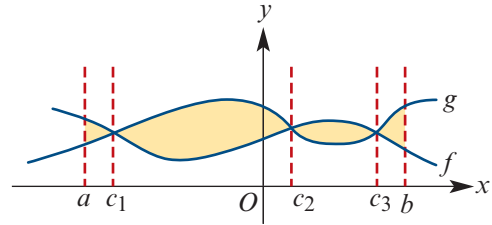

To find the area of the shaded region, we must consider the intervals $[a, c_1]$, $[c_1, c_2]$, $[c_2, c_3]$ and $[c_3, b]$ separately. Thus, the shaded area is given by

$$\int_a^{c_1} f(x) - g(x) dx + \int_{c_1}^{c_2} g(x) - f(x) dx + \int_{c_2}^{c_3} f(x) - g(x) dx + \int_{c_3}^b g(x) - f(x) dx$$

The absolute value function could also be used here:

$$\left| \int_a^{c_1} f(x) - g(x) dx \right| + \left| \int_{c_1}^{c_2} f(x) - g(x) dx \right| + \left| \int_{c_2}^{c_3} f(x) - g(x) dx \right| + \left| \int_{c_3}^b f(x) - g(x) dx \right|$$



Example 8

Find the area of the region enclosed by the graphs of $f(x) = x^3$ and $g(x) = x$.

Solution

The graphs intersect where $f(x) = g(x)$:

$$x^3 = x$$

$$x^3 - x = 0$$

$$x(x^2 - 1) = 0$$

$$\therefore x = 0 \text{ or } x = \pm 1$$

We see that:

- $f(x) \geq g(x)$ for $-1 \leq x \leq 0$
- $f(x) \leq g(x)$ for $0 \leq x \leq 1$

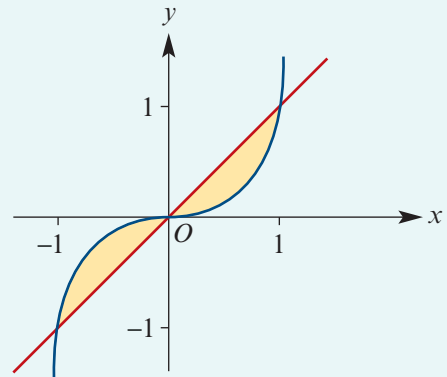

Thus the area is given by

$$\begin{aligned} \int_{-1}^0 f(x) - g(x) dx + \int_0^1 g(x) - f(x) dx &= \int_{-1}^0 x^3 - x dx + \int_0^1 x - x^3 dx \\ &= \left[\frac{x^4}{4} - \frac{x^2}{2} \right]_{-1}^0 + \left[\frac{x^2}{2} - \frac{x^4}{4} \right]_0^1 \\ &= -\left(-\frac{1}{4}\right) + \frac{1}{4} \\ &= \frac{1}{2} \end{aligned}$$

Note: The result could also be obtained by observing the symmetry of the graphs, finding the area of the region where both x and y are non-negative, and then multiplying by 2.

Using the TI-Nspire

Method 1

In a **Calculator** page:

- Enter the integral as shown.
(Use the 2D-template palette \int for the definite integral and the absolute value.)

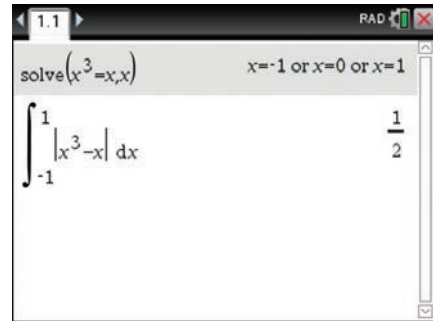

Method 2

In a **Graphs** page:

- Enter the functions $f_1(x) = x^3$ and $f_2(x) = x$ as shown.
- To find the area of the bounded region, use $\text{menu} > \text{Analyze Graph} > \text{Bounded Area}$ and click on the lower and upper intersections of the graphs.

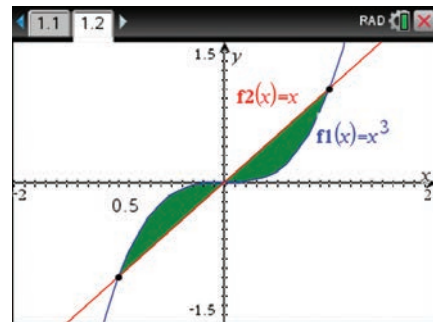

Using the Casio ClassPad

Method 1

- In $\sqrt{\square}$, solve the equation $x^3 = x$ to find the limits for the integral.
- Enter and highlight $|x^3 - x|$.
- Go to **Interactive** > **Calculation** > \int .
- Select **Definite**. Enter -1 for the lower limit and 1 for the upper limit. Then tap OK .

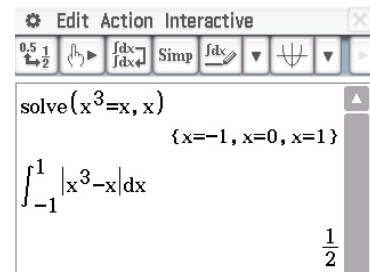

Method 2

- Graph the functions $y_1 = x^3$ and $y_2 = x$.
- Go to **Analysis** > **G-Solve** > **Integral** > $\int dx$ **intersection**.
- Press execute at $x = -1$. Use the cursor key to go to $x = 1$ and press execute again.

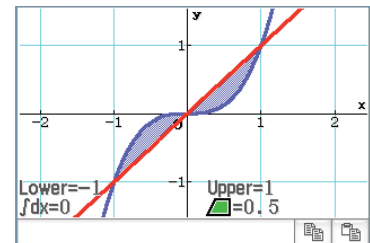

Note: Here the absolute value function is used to simplify the process of finding areas with a CAS calculator. This technique is not helpful when doing these problems by hand.



Example 9

Find the area of the shaded region.

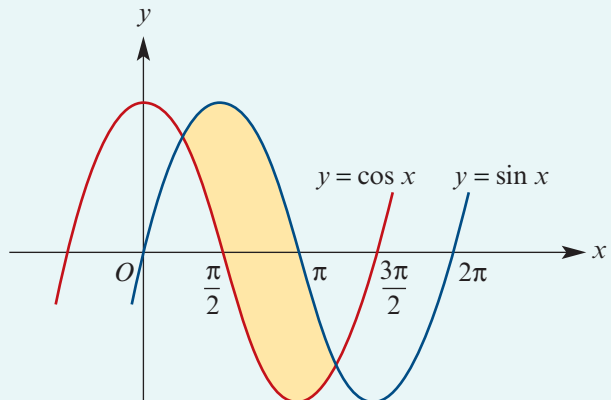

Solution

First find the x -coordinates of the two points of intersection.

If $\sin x = \cos x$, then $\tan x = 1$ and so $x = \frac{\pi}{4}$ or $x = \frac{5\pi}{4}$.

$$\begin{aligned}
 \text{Area} &= \int_{\frac{\pi}{4}}^{\frac{5\pi}{4}} \sin x - \cos x \, dx \\
 &= \left[-\cos x - \sin x \right]_{\frac{\pi}{4}}^{\frac{5\pi}{4}} \\
 &= -\cos\left(\frac{5\pi}{4}\right) - \sin\left(\frac{5\pi}{4}\right) - \left(-\cos\left(\frac{\pi}{4}\right) - \sin\left(\frac{\pi}{4}\right) \right) \\
 &= \frac{1}{\sqrt{2}} + \frac{1}{\sqrt{2}} + \frac{1}{\sqrt{2}} + \frac{1}{\sqrt{2}} \\
 &= \frac{4}{\sqrt{2}} = 2\sqrt{2}
 \end{aligned}$$

The area is $2\sqrt{2}$ square units.

Example 10

Find the area of the shaded region.

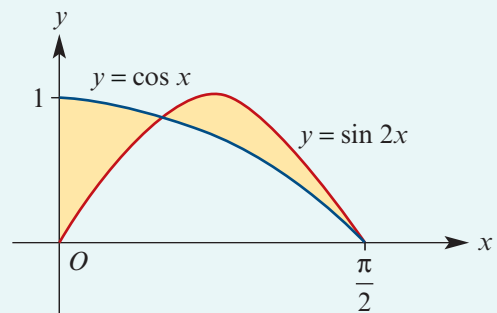

Solution

First determine the points of intersection:

$$\cos x = \sin(2x)$$

$$\cos x = 2 \sin x \cos x$$

$$0 = \cos x (2 \sin x - 1)$$

$$\therefore \cos x = 0 \text{ or } \sin x = \frac{1}{2}$$

Therefore $x = \frac{\pi}{2}$ or $x = \frac{\pi}{6}$ for $x \in \left[0, \frac{\pi}{2}\right]$.

$$\begin{aligned} \text{Area} &= \int_0^{\frac{\pi}{6}} \cos x - \sin(2x) \, dx + \int_{\frac{\pi}{6}}^{\frac{\pi}{2}} \sin(2x) - \cos x \, dx \\ &= \left[\sin x + \frac{1}{2} \cos(2x) \right]_0^{\frac{\pi}{6}} + \left[-\frac{1}{2} \cos(2x) - \sin x \right]_{\frac{\pi}{6}}^{\frac{\pi}{2}} \\ &= \left(\frac{1}{2} + \frac{1}{4} - \frac{1}{2} \right) + \left(\frac{1}{2} - 1 - \left(-\frac{1}{4} - \frac{1}{2} \right) \right) \\ &= \frac{1}{4} - \frac{1}{2} + \frac{1}{4} + \frac{1}{2} \\ &= \frac{1}{2} \end{aligned}$$

Exercise 12B**Skillsheet**

- 1** Find the coordinates of the points of intersection of the two curves with equations $y = x^2 - 2x$ and $y = -x^2 + 8x - 12$. Find the area of the region enclosed between the two curves.

Example 6

- 2** Find the area of the region enclosed by the graphs of $y = -x^2$ and $y = x^2 - 2x$.

- 3** Find the area of:

a region A

b region B

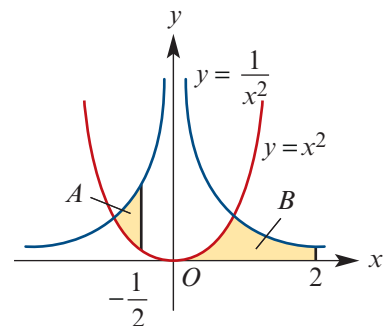

- 4** Let $f: \mathbb{R} \rightarrow \mathbb{R}$, $f(x) = x^2 - 4$. Sketch the graphs of $y = f(x)$ and $y = \frac{16}{f(x)}$ on the same set of axes. Find the area of the region bounded by the two graphs and the lines $x = 1$ and $x = -1$.

- 5 The area of the region bounded by $y = \frac{12}{x}$, $x = 1$ and $x = a$ is 24. Find the value of a .

Example 8

- 6 Find the area of:

- a region A
b region B
c region C

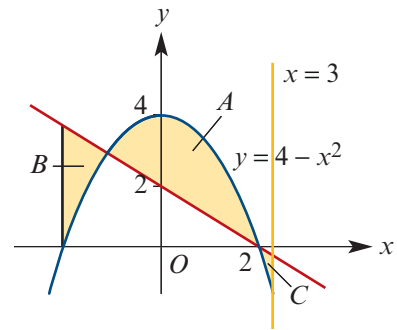

Example 9, 10

- 7 For each of the following, find the area of the region enclosed by the lines and curves. Draw a sketch graph and shade the appropriate region for each example.

- a $y = 2 \sin x$ and $y = \sin(2x)$, for $0 \leq x \leq \pi$
b $y = \sin(2x)$ and $y = \cos x$, for $\frac{-\pi}{2} \leq x \leq \frac{\pi}{2}$
c $y = \sqrt{x}$, $y = 6 - x$ and $y = 1$
d $y = \frac{2}{1 + x^2}$ and $y = 1$
e $y = \sin^{-1} x$, $x = \frac{1}{2}$ and $y = 0$
f $y = \cos(2x)$ and $y = 1 - \sin x$, for $0 \leq x \leq \pi$
g $y = \frac{1}{3}(x^2 + 1)$ and $y = \frac{3}{x^2 + 1}$

- 8 Evaluate each of the following. (Draw the appropriate graph first.)

- a $\int_1^e \ln x \, dx$
b $\int_{\frac{1}{2}}^1 \ln(2x) \, dx$

Hint: You can use the inverse relationship $y = \ln x \Leftrightarrow x = e^y$. First find the area between the curve and the y -axis.

- 9 Let $f: \mathbb{R} \rightarrow \mathbb{R}$, $f(x) = xe^x$.
- a Find the derivative of f .
b Find $\{x : f'(x) = 0\}$.
c Sketch the curve $y = f(x)$.
d Find the equation of the tangent to this curve at $x = -1$.
e Find the area of the region bounded by this tangent, the curve and the y -axis.
- 10 Let P be the point with coordinates $(1, 1)$ on the curve with equation $y = 1 + \ln x$.
- a Find the equation of the normal to the curve at P .
b Find the area of the region enclosed by the normal, the curve and the x -axis.

- 11 a** Find the coordinates of the points of intersection of the curves with equations $y = (x - 1)(x - 2)$ and $y = \frac{3(x - 1)}{x}$.
- b** Sketch the two curves on the one set of axes.
- c** Find the area of the region bounded by the two curves for $1 \leq x \leq 3$.
- 12** Show that the area of the shaded region is 2.

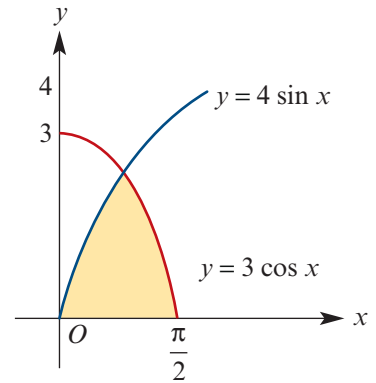

- 13** The graphs of $y = 9 - x^2$ and $y = \frac{1}{\sqrt{9 - x^2}}$ are as shown.
- a** Find the coordinates of the points of intersection of the two graphs.
- b** Find the area of the shaded region.

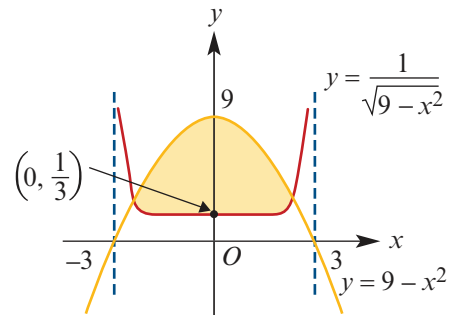

- 14** Find the area enclosed by the graphs of $y = x^2$ and $y = x + 2$.

- 15** Consider the functions $f(x) = \frac{10}{1 + x^2}$ for $x \geq 0$ and $g(x) = e^{x-3}$ for $x \geq 0$.

The graphs of $y = f(x)$ and $y = g(x)$ intersect at the point $(3, 1)$. Find, correct to three decimal places, the area of the region enclosed by the two graphs and the line with equation $x = 1$.

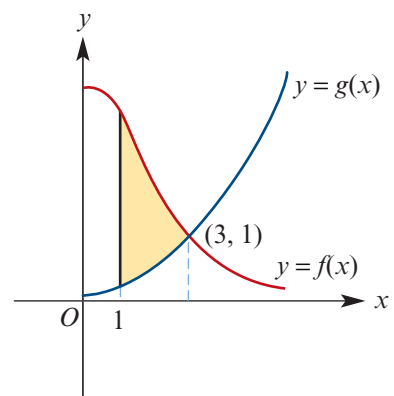

- 16** The graph of the function $f: [0, 6) \rightarrow \mathbb{R}$, where $f(x) = \frac{8\sqrt{5}}{\sqrt{36-x^2}} - x$, is shown.

- a** Find the values of a and b .
b Find the total area of the shaded regions.

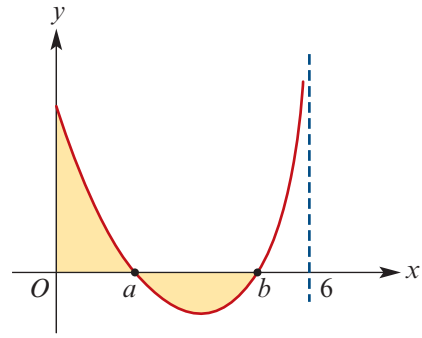

- 17** The graphs of $y = \cos^2 x$ and $y = \sin^2 x$ are shown for $0 \leq x \leq 2\pi$. Find the total area of the shaded regions.

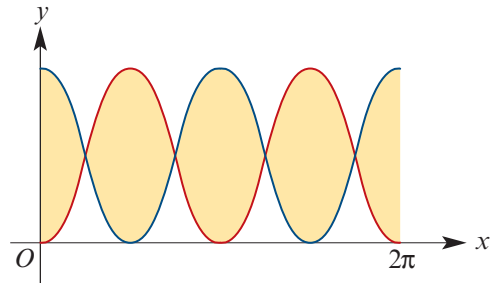

12C Integration using a CAS calculator

In Chapter 11, we discussed methods of integration by rule. In this section, we consider the use of a CAS calculator in evaluating definite integrals. It is often not possible to determine the antiderivative of a given function by rule, and so we will also look at numerical evaluation of definite integrals.

Using a calculator to find exact values of definite integrals

Example 11

Use a CAS calculator to evaluate $\int_0^{\frac{1}{2}} \sqrt{1-x^2} dx$.

Using the TI-Nspire

To find a definite integral, use **(menu)** > **Calculus** > **Integral**.

Note: The integral template can also be obtained directly from the 2D-template palette **($\frac{\pi}{18}$)** or by pressing **(shift)** **(+)**.

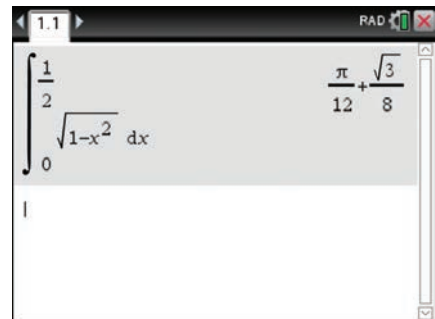

Using the Casio ClassPad

- Enter and highlight the expression $\sqrt{1-x^2}$.
- Go to **Interactive** > **Calculation** > \int .
- Select **Definite**. Enter 0 for the lower limit and $\frac{1}{2}$ for the upper limit. Then tap OK.

Note: The integral template \int_a^b can also be found in the **Math2** keyboard.

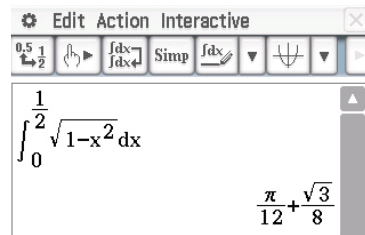

Using the inverse function to find a definite integral

Example 12

Find the area of the region bounded by the graph of $y = \ln x$, the line $x = 2$ and the x -axis by using the inverse function.

Solution

From the graph, we see that

$$\begin{aligned} \int_1^2 \ln x \, dx &= 2 \ln 2 - \int_0^{\ln 2} e^y \, dy \\ &= 2 \ln 2 - (e^{\ln 2} - e^0) \\ &= 2 \ln 2 - (2 - 1) \\ &= 2 \ln 2 - 1 \end{aligned}$$

The area is $2 \ln 2 - 1$ square units.

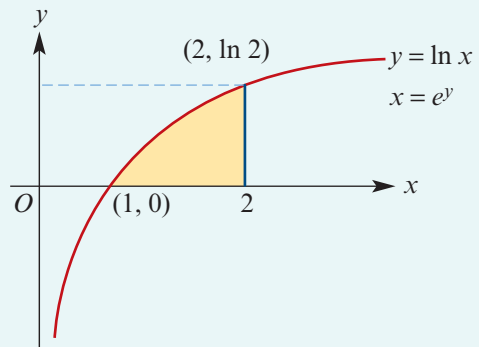

This area can also be found using integration by parts or using a CAS calculator.

Using the TI-Nspire

To find a definite integral, use **menu** > **Calculus** > **Integral** or select the integral template from the 2D-template palette \int_a^b .



Using the Casio ClassPad

- Enter and highlight the expression $\ln(x)$.
- Go to **Interactive** > **Calculation** > \int .
- Select **Definite**, enter the lower and upper limits and tap OK.

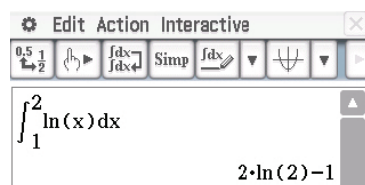

Using a calculator to find approximate values of definite integrals

Example 13

The graph of $y = e^{\sin x} - 2$ is as shown. Using a CAS calculator, find the area of the shaded regions.

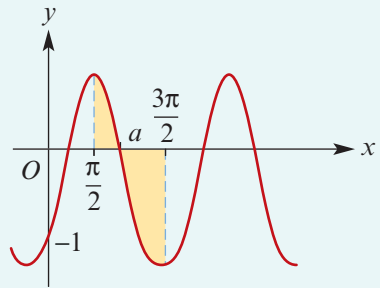

Solution

Using a CAS calculator, first find the value of a , which is approximately 2.37575.

$$\begin{aligned} \text{Required area} &= \int_{\frac{\pi}{2}}^a (e^{\sin x} - 2) dx - \int_a^{\frac{3\pi}{2}} (e^{\sin x} - 2) dx \\ &= 0.369\,213\dots + 2.674\,936\dots \\ &= 3.044\,149\dots \end{aligned}$$

The area is approximately 3.044 square units.

Using the fundamental theorem of calculus

We have used the fundamental theorem of calculus to find areas using antiderivatives. We can also use the theorem to define antiderivatives using area functions.

If F is an antiderivative of a continuous function f , then $F(b) - F(a) = \int_a^b f(x) dx$. Using a dummy variable t , we can write $F(x) - F(a) = \int_a^x f(t) dt$, giving $F(x) = F(a) + \int_a^x f(t) dt$.

If we define a function by $G(x) = \int_a^x f(t) dt$, then F and G differ by a constant, and so G is also an antiderivative of f .

Example 14

Plot the graph of $F(x) = \int_1^x \frac{1}{t} dt$ for $x > 1$.

Using the TI-Nspire

In a **Graphs** page, enter the function

$$f1(x) = \int_1^x \frac{1}{t} dt$$

Note: The integral template can be obtained from the 2D-template palette .

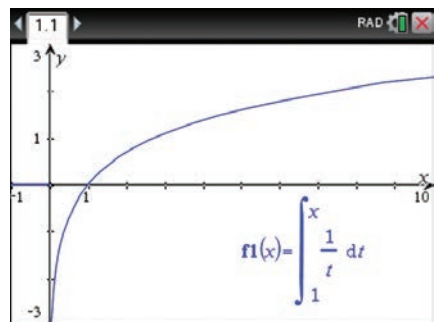

Using the Casio ClassPad

- Enter and define the function as shown.
- Graph the function with the restricted domain.

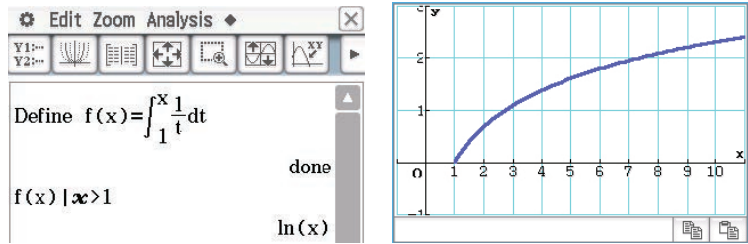

Note: The natural logarithm function can be defined by $\ln(x) = \int_1^x \frac{1}{t} dt$.

The number e can then be defined to be the unique real number a such that $\ln(a) = 1$.

Example 15

Use a CAS calculator to find an approximate value of $\int_0^{\pi/3} \cos(x^2) dx$ and to plot the graph of $f(x) = \int_0^x \cos(t^2) dt$ for $-\frac{\pi}{4} \leq x \leq \pi$.

Using the TI-Nspire

Method 1

- Use **menu** > **Actions** > **Define** to define the function as shown and evaluate for $x = \frac{\pi}{3}$.

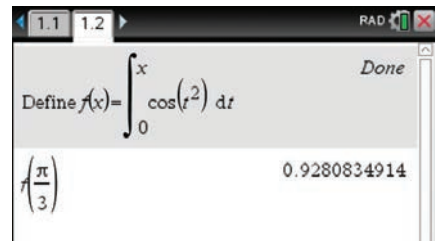

Method 2

- Plot the graph of $f1(x) = \cos(x^2)$ for $-\frac{\pi}{4} \leq x \leq \pi$.
- To find the required area, use the integral measurement tool from **menu** > **Analyze Graph** > **Integral**. Type in the lower limit 0 and press **enter**. Move to the right, type in the upper limit $\pi/3$ and press **enter**.

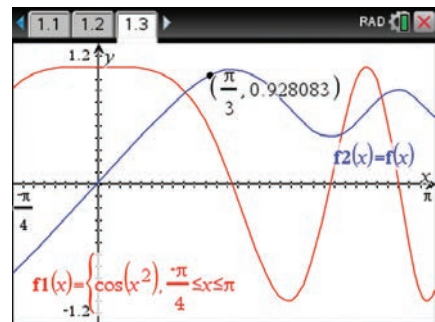
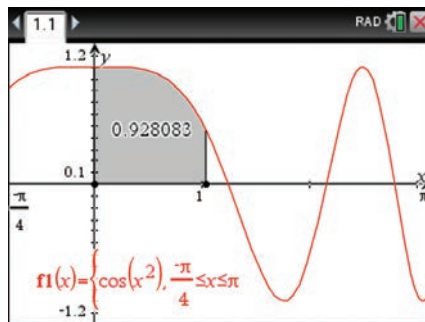

Using the Casio ClassPad

- Enter and highlight the expression $\cos(x^2)$.
- Go to **Interactive** > **Calculation** > f .
- Select **Definite** and enter the lower and upper limits as shown.

- Define the function $f(x) = \int_0^x \cos(t^2) dt$.
- Graph the function with the restricted domain.

- The approximate value of $f\left(\frac{\pi}{3}\right)$ can now be found graphically using **Analysis** > **G-Solve** > **y-Cal**.

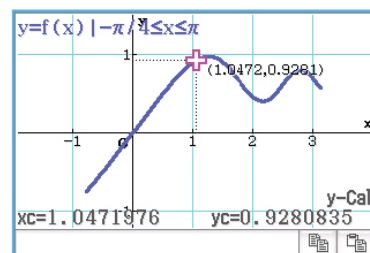
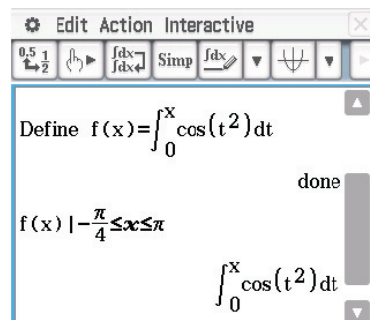
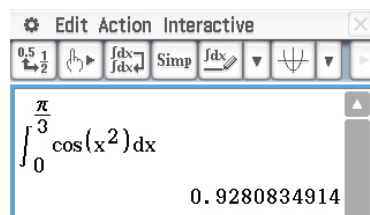

Exercise 12C

Example 11 1 For each of the following, evaluate the integral using a CAS calculator to obtain an exact value:

a $\int_0^3 \sqrt{9-x^2} dx$ **b** $\int_0^3 \sqrt{9x^2-x^3} dx$ **c** $\int_0^3 \ln(x^2+1) dx$

Example 12 2 For each of the following, determine the exact value both by using the inverse function and by using your CAS calculator:

a $\int_0^{\frac{1}{2}} \arcsin(2x) dx$ **b** $\int_3^4 \ln(x-2) dx$ **c** $\int_0^{\frac{1}{2}} \arctan(2x) dx$

Example 13 3 Using a CAS calculator, evaluate each of the following correct to two decimal places:

a $\int_0^2 e^{\sin x} dx$ **b** $\int_0^\pi x \sin x dx$ **c** $\int_1^3 (\ln x)^2 dx$ **d** $\int_{-1}^1 \cos(e^x) dx$

e $\int_{-1}^2 \frac{e^x}{e^x + e^{-x}} dx$ **f** $\int_0^2 \frac{x}{x^4+1} dx$ **g** $\int_1^2 x \ln x dx$ **h** $\int_{-1}^1 x^2 e^x dx$

i $\int_0^1 \sqrt{1+x^4} dx$ **j** $\int_0^{\frac{\pi}{2}} \sin(x^2) dx$

- 4 In each of the following, the rule of the function is defined as an area function. Find $f(x)$ in each case.

a $f(x) = \int_1^x \frac{1}{t} dt$, for $x > 1$

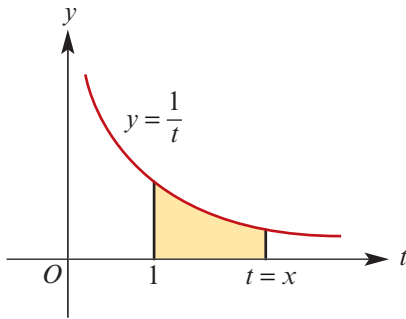

b $f(x) = \int_x^1 \frac{1}{t} dt$, for $0 < x < 1$

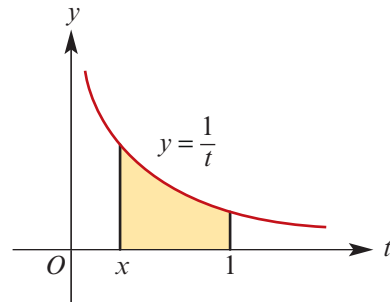

c $f(x) = \int_0^x e^t dt$, for $x \in \mathbb{R}$

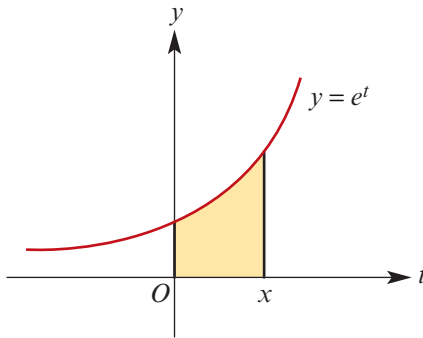

d $f(x) = \int_0^x \sin t dt$, for $x \in \mathbb{R}$

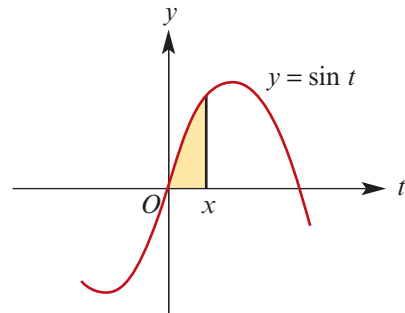

e $f(x) = \int_{-1}^x \frac{1}{1+t^2} dt$, for $x \in \mathbb{R}$

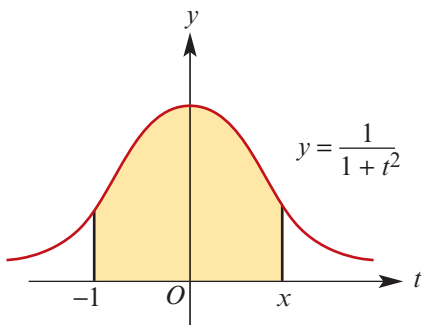

f $f(x) = \int_0^x \frac{1}{\sqrt{1-t^2}} dt$, for $-1 < x < 1$

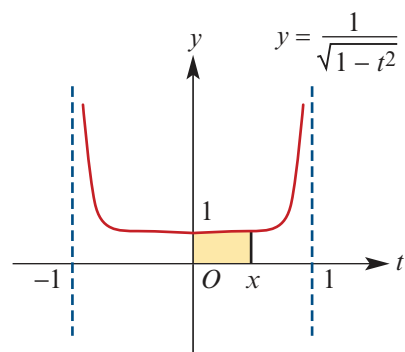

Example 14 5 Use a CAS calculator to plot the graph of each of the following:

a $f(x) = \int_0^x \tan^{-1} t dt$

b $f(x) = \int_0^x e^{t^2} dt$

c $f(x) = \int_0^x \sin^{-1} t dt$

d $f(x) = \int_0^x \sin(t^2) dt$

e $f(x) = \int_1^x \frac{\sin t}{t} dt$, $x > 1$



12D Volumes of solids of revolution

A large glass flask has a shape as illustrated in the figure below. In order to find its approximate volume, consider the flask as a series of cylinders.

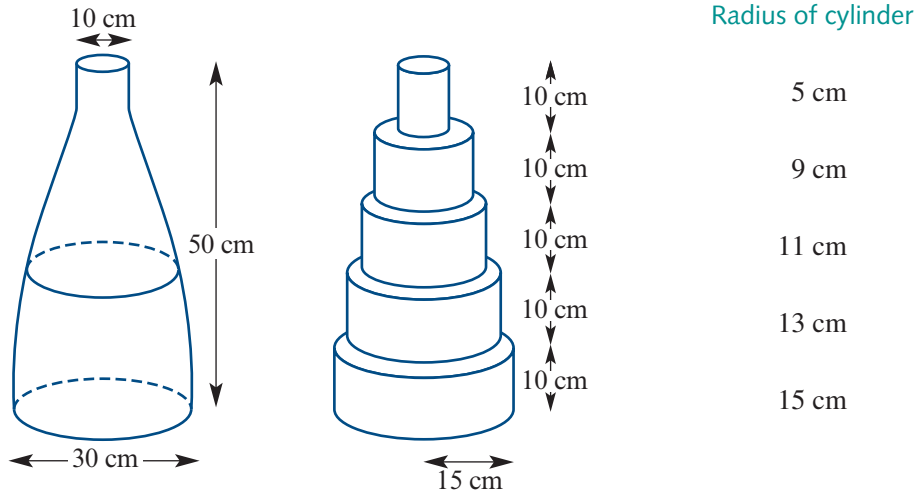

$$\begin{aligned} \therefore \text{Volume of flask} &\approx \pi(15^2 + 13^2 + 11^2 + 9^2 + 5^2) \times 10 \\ &\approx 19\,509.29 \text{ cm}^3 \\ &\approx 19 \text{ litres} \end{aligned}$$

This estimate can be improved by taking more cylinders to obtain a better approximation.

In Mathematical Methods Year 12, it was shown that areas defined by well-behaved functions can be determined as the limit of a sum.

This can also be done for volumes. The volume of a typical thin slice is $A\delta x$, and the approximate total volume is

$$\sum_{x=a}^{x=b} A\delta x$$

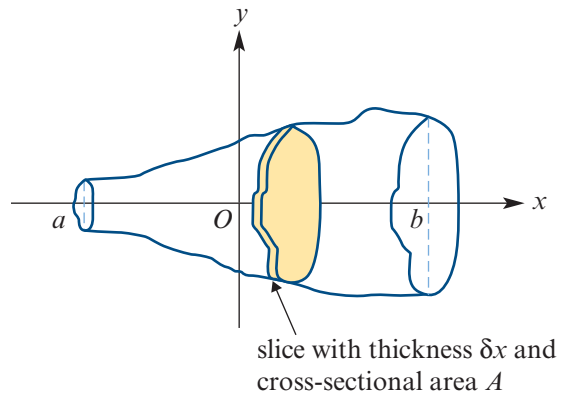

Volume of a sphere

Consider the graph of $f(x) = \sqrt{4 - x^2}$.

If the shaded region is rotated around the x -axis, it will form a sphere of radius 2.

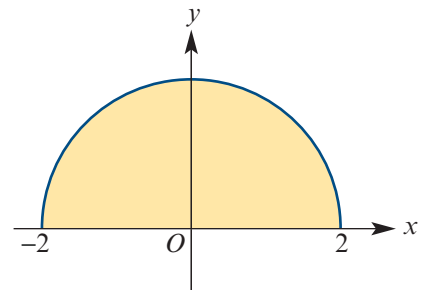

Divide the interval $[-2, 2]$ into n subintervals $[x_{i-1}, x_i]$ with $x_0 = -2$ and $x_n = 2$.

The volume of a typical slice (a cylinder) is approximately $\pi(f(c_i))^2(x_i - x_{i-1})$, where $c_i \in [x_{i-1}, x_i]$.

The total volume will be approximated by the sum of the volumes of these slices. As the number of slices n gets larger and larger:

$$V = \lim_{n \rightarrow \infty} \sum_{i=1}^n \pi(f(c_i))^2(x_i - x_{i-1})$$

It has been seen that the limit of such a sum is an integral and therefore:

$$\begin{aligned} V &= \int_{-2}^2 \pi(f(x))^2 dx \\ &= \int_{-2}^2 \pi(4 - x^2) dx \\ &= \pi \left[4x - \frac{x^3}{3} \right]_{-2}^2 \\ &= \pi \left(8 - \frac{8}{3} - \left(-8 + \frac{8}{3} \right) \right) \\ &= \pi \left(16 - \frac{16}{3} \right) \\ &= \frac{32\pi}{3} \end{aligned}$$

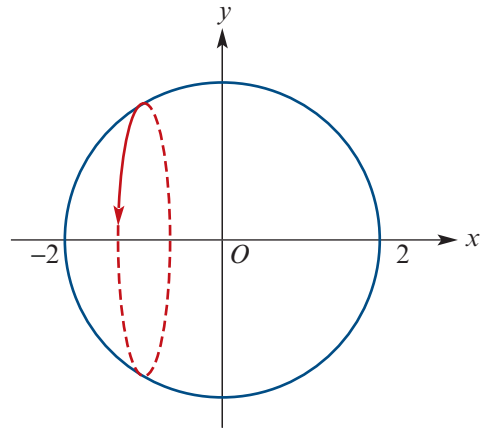

Volume of a cone

If the region between the line $y = \frac{1}{2}x$, the line $x = 4$ and the x -axis is rotated around the x -axis, then a solid in the shape of a cone is produced.

The volume of the cone is given by:

$$\begin{aligned} V &= \int_0^4 \pi y^2 dx \\ &= \int_0^4 \pi \left(\frac{1}{2}x \right)^2 dx \\ &= \frac{\pi}{4} \left[\frac{x^3}{3} \right]_0^4 \\ &= \frac{\pi}{4} \times \frac{64}{3} \\ &= \frac{16\pi}{3} \end{aligned}$$

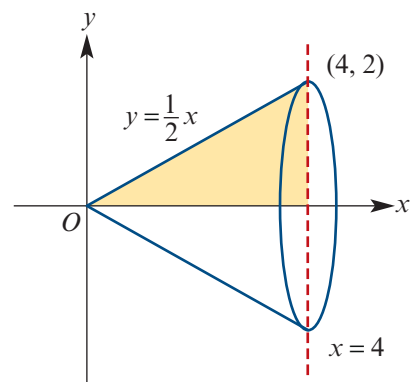

Solids of revolution

In general, the solid formed by rotating a region about a line is called a **solid of revolution**.

For example, if the region between the graph of $y = x^2$, the line $y = 20$ and the y -axis is rotated about the y -axis, then a solid in the shape of the top of a wine glass is produced.

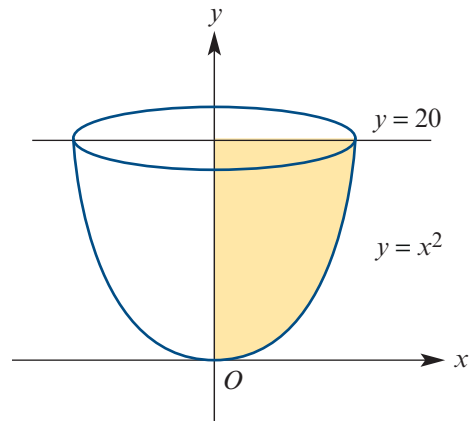

Volume of a solid of revolution

■ Rotation about the x -axis

If the region to be rotated is bounded by the curve with equation $y = f(x)$, the lines $x = a$ and $x = b$ and the x -axis, then

$$\begin{aligned} V &= \int_{x=a}^{x=b} \pi y^2 dx \\ &= \pi \int_a^b (f(x))^2 dx \end{aligned}$$

■ Rotation about the y -axis

If the region to be rotated is bounded by the curve with equation $x = f(y)$, the lines $y = a$ and $y = b$ and the y -axis, then

$$\begin{aligned} V &= \int_{y=a}^{y=b} \pi x^2 dy \\ &= \pi \int_a^b (f(y))^2 dy \end{aligned}$$

Example 16

Find the volume of the solid of revolution formed by rotating the curve $y = x^3$ about:

a the x -axis for $0 \leq x \leq 1$

b the y -axis for $0 \leq y \leq 1$

Solution

$$\begin{aligned} \mathbf{a} \quad V &= \pi \int_0^1 y^2 dx \\ &= \pi \int_0^1 x^6 dx \\ &= \pi \left[\frac{x^7}{7} \right]_0^1 \\ &= \frac{\pi}{7} \end{aligned}$$

$$\begin{aligned} \mathbf{b} \quad V &= \pi \int_0^1 x^2 dy \\ &= \pi \int_0^1 y^{\frac{2}{3}} dy \\ &= \pi \left[\frac{3}{5} y^{\frac{5}{3}} \right]_0^1 \\ &= \frac{3\pi}{5} \end{aligned}$$

Regions not bounded by the x -axis

If the shaded region is rotated about the x -axis, then the volume V is given by

$$V = \pi \int_a^b (f(x))^2 - (g(x))^2 dx$$

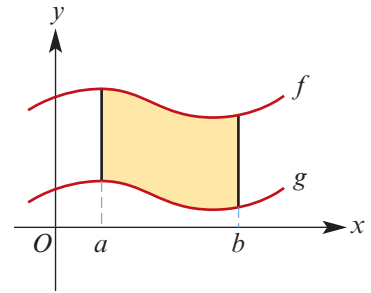

Example 17

Find the volume of the solid of revolution when the region bounded by the graphs of $y = 2e^{2x}$, $y = 1$, $x = 0$ and $x = 1$ is rotated around the x -axis.

Solution

The volume is given by

$$\begin{aligned} V &= \pi \int_0^1 4e^{4x} - 1 dx \\ &= \pi [e^{4x} - x]_0^1 \\ &= \pi(e^4 - 1 - (1)) \\ &= \pi(e^4 - 2) \end{aligned}$$

Note: Here $f(x) = 2e^{2x}$ and $g(x) = 1$.

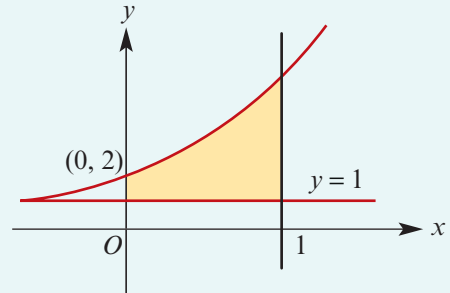

Example 18

The shaded region is rotated around the x -axis.
Find the volume of the resulting solid.

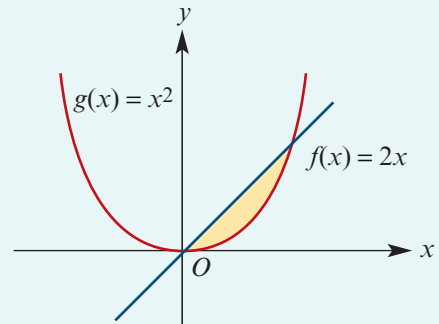

Solution

The graphs meet where $2x = x^2$, i.e. at the points with coordinates $(0, 0)$ and $(2, 4)$.

$$\begin{aligned} \text{Volume} &= \pi \int_0^2 (f(x))^2 - (g(x))^2 dx \\ &= \pi \int_0^2 4x^2 - x^4 dx \\ &= \pi \left[\frac{4x^3}{3} - \frac{x^5}{5} \right]_0^2 \\ &= \pi \left(\frac{32}{3} - \frac{32}{5} \right) = \frac{64\pi}{15} \end{aligned}$$

**Example 19**

A solid is formed when the region bounded by the x -axis and the graph of $y = 3 \sin(2x)$, $0 \leq x \leq \frac{\pi}{2}$, is rotated around the x -axis. Find the volume of this solid.

Solution

$$\begin{aligned}
 V &= \pi \int_0^{\frac{\pi}{2}} (3 \sin(2x))^2 dx \\
 &= \pi \int_0^{\frac{\pi}{2}} 9 \sin^2(2x) dx \\
 &= 9\pi \int_0^{\frac{\pi}{2}} \sin^2(2x) dx \\
 &= 9\pi \int_0^{\frac{\pi}{2}} \frac{1}{2} (1 - \cos(4x)) dx \\
 &= \frac{9\pi}{2} \int_0^{\frac{\pi}{2}} 1 - \cos(4x) dx \\
 &= \frac{9\pi}{2} \left[x - \frac{1}{4} \sin(4x) \right]_0^{\frac{\pi}{2}} \\
 &= \frac{9\pi}{2} \left(\frac{\pi}{2} \right) \\
 &= \frac{9\pi^2}{4}
 \end{aligned}$$

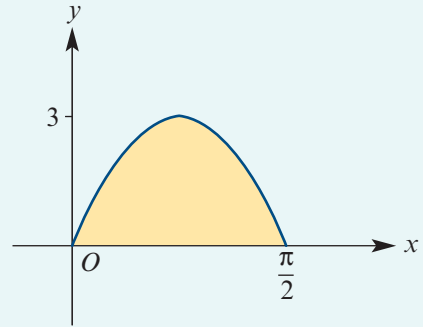
**Example 20**

The curve $y = 2 \sin^{-1} x$, $0 \leq x \leq 1$, is rotated around the y -axis to form a solid of revolution. Find the volume of this solid.

Solution

$$\begin{aligned}
 V &= \pi \int_0^{\pi} \sin^2\left(\frac{y}{2}\right) dy \\
 &= \frac{\pi}{2} \int_0^{\pi} 1 - \cos y dy \\
 &= \frac{\pi}{2} [y - \sin y]_0^{\pi} \\
 &= \frac{\pi^2}{2}
 \end{aligned}$$

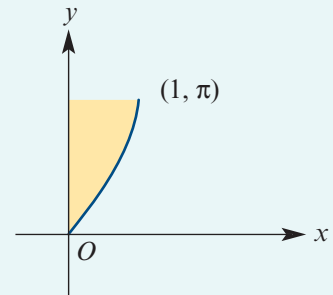
**Exercise 12D****Skillsheet****Example 16**

- 1 Find the area of the region bounded by the x -axis and the curve whose equation is $y = 4 - x^2$. Also find the volume of the solid formed when this region is rotated about the y -axis.

- 2** Find the volume of the solid of revolution when the region bounded by the given curve, the x -axis and the given lines is rotated about the x -axis:

a $f(x) = \sqrt{x}$, $x = 4$

b $f(x) = 2x + 1$, $x = 0$, $x = 4$

c $f(x) = 2x - 1$, $x = 4$

d $f(x) = \sin x$, $0 \leq x \leq \frac{\pi}{2}$

e $f(x) = e^x$, $x = 0$, $x = 2$

f $f(x) = \sqrt{9 - x^2}$, $-3 \leq x \leq 3$

- 3** The hyperbola $x^2 - y^2 = 1$ is rotated around the x -axis to form a surface of revolution. Find the volume of the solid enclosed by this surface between $x = 1$ and $x = \sqrt{3}$.

- 4** Find the volumes of the solids generated by rotating about the x -axis each of the regions bounded by the following curves and lines:

a $y = \frac{1}{x}$, $y = 0$, $x = 1$, $x = 4$

b $y = x^2 + 1$, $y = 0$, $x = 0$, $x = 1$

c $y = \sqrt{x}$, $y = 0$, $x = 2$

d $y = \sqrt{a^2 - x^2}$, $y = 0$

e $y = \sqrt{9 - x^2}$, $y = 0$

f $y = \sqrt{9 - x^2}$, $y = 0$, $x = 0$, given $x \geq 0$

Example 17, 18

- 5** The region bounded by the line $y = 5$ and the curve $y = x^2 + 1$ is rotated about the x -axis. Find the volume generated.

Example 19

- 6** The region, for which $x \geq 0$, bounded by the curves $y = \cos x$ and $y = \sin x$ and the y -axis is rotated around the x -axis, forming a solid of revolution. By using the identity $\cos(2x) = \cos^2 x - \sin^2 x$, obtain a volume for this solid.

- 7** The region enclosed by $y = \frac{4}{x^2}$, $x = 4$, $x = 1$ and the x -axis is rotated about the x -axis. Find the volume generated.

- 8** The region enclosed by $y = x^2$ and $y^2 = x$ is rotated about the x -axis. Find the volume generated.

- 9** A region is bounded by the curve $y = \sqrt{6 - x}$, the straight line $y = x$ and the positive x -axis. Find the volume of the solid of revolution formed by rotating this figure about the x -axis.

- 10** The region bounded by the x -axis, the line $x = \frac{\pi}{2}$ and the curve $y = \tan\left(\frac{x}{2}\right)$ is rotated about the x -axis. Prove that the volume of the solid of revolution is $\frac{\pi}{2}(4 - \pi)$.

Hint: Use the result that $\tan^2\left(\frac{x}{2}\right) = \sec^2\left(\frac{x}{2}\right) - 1$.

- 11** Sketch the graphs of $y = \sin x$ and $y = \sin(2x)$ for $0 \leq x \leq \frac{\pi}{2}$. Show that the area of the region bounded by these graphs is $\frac{1}{4}$ square unit, and the volume formed by rotating this region about the x -axis is $\frac{3}{16}\pi\sqrt{3}$ cubic units.

12 Let V be the volume of the solid formed when the region enclosed by $y = \frac{1}{x}$, $y = 0$, $x = 4$ and $x = b$, where $0 < b < 4$, is rotated about the x -axis. Find the value of b for which $V = 3\pi$.

13 Find the volume of the solid generated when the region enclosed by $y = \sqrt{3x+1}$, $y = \sqrt{3x}$, $y = 0$ and $x = 1$ is rotated about the x -axis.

Example 20

14 Find the volumes of the solids formed when the following regions are rotated around the y -axis:

a $x^2 = 4y^2 + 4$ for $0 \leq y \leq 1$

b $y = \ln(2-x)$ for $0 \leq y \leq 2$

15 a Find the area of the region bounded by the curve $y = e^x$, the tangent at the point $(1, e)$ and the y -axis.

b Find the volume of the solid formed by rotating this region through a complete revolution about the x -axis.

16 The region defined by the inequalities $y \geq x^2 - 2x + 4$ and $y \leq 4$ is rotated about the line $y = 4$. Find the volume generated.

17 The region enclosed by $y = \cos\left(\frac{x}{2}\right)$ and the x -axis, for $0 \leq x \leq \pi$, is rotated about the x -axis. Find the volume generated.

18 Find the volume generated by revolving the region enclosed between the parabola $y = 3x - x^2$ and the line $y = 2$ about the x -axis.

19 The shaded region is rotated around the x -axis to form a solid of revolution. Find the volume of this solid.

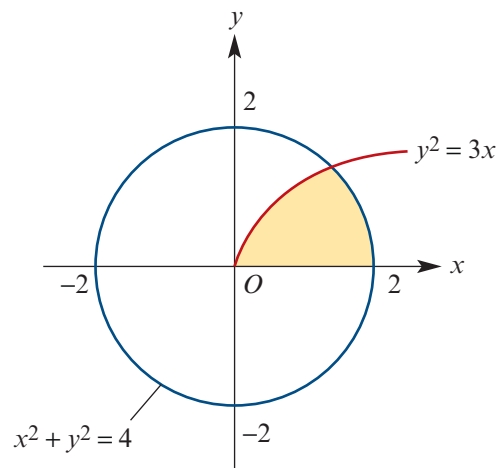

20 The region enclosed between the curve $y = e^x - 1$, the x -axis and the line $x = \ln 2$ is rotated around the x -axis to form a solid of revolution. Find the volume of this solid.

21 Show that the volume of the solid of revolution formed by rotating about the x -axis the region bounded by the curve $y = e^{-2x}$ and the lines $x = 0$, $y = 0$ and $x = \ln 2$ is $\frac{15\pi}{64}$.

- 22** Find the volume of the solid generated by revolving about the x -axis the region bounded by the graph of $y = 2 \tan x$ and the lines $x = -\frac{\pi}{4}$, $x = \frac{\pi}{4}$ and $y = 0$.

- 23** The region bounded by the parabola $y^2 = 4(1 - x)$ and the y -axis is rotated about:
a the x -axis **b** the y -axis.

Prove that the volumes of the solids formed are in the ratio 15 : 16.

- 24** The region bounded by the graph of $y = \frac{1}{\sqrt{x^2 + 9}}$, the x -axis, the y -axis and the line $x = 4$ is rotated about:

- a** the x -axis **b** the y -axis.

Find the volume of the solid formed in each case.

- 25** A bucket is defined by rotating the curve with equation

$$y = 40 \ln\left(\frac{x-20}{10}\right), \quad 0 \leq y \leq 40$$

about the y -axis. If x and y are measured in centimetres, find the maximum volume of liquid that the bucket could hold. Give the answer to the nearest cm^3 .

- 26** An ellipse has equation $\frac{x^2}{a^2} + \frac{y^2}{b^2} = 1$. Find the volume of the solid generated when the region bounded by the ellipse is rotated about:

- a** the x -axis **b** the y -axis.

- 27** The diagram shows part of the curve $y = \frac{12}{x}$.

Points $P(2, 6)$ and $Q(6, 2)$ lie on the curve.

Find:

- a** the equation of the line PQ
b the volume obtained when the shaded region is rotated about:
i the x -axis **ii** the y -axis.

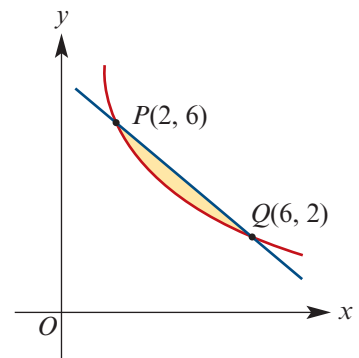

- 28 a** Sketch the graph of $y = 2x + \frac{9}{x}$.

- b** Find the volume generated when the region bounded by the curve $y = 2x + \frac{9}{x}$ and the lines $x = 1$ and $x = 3$ is rotated about the x -axis.

- 29** The region shown is rotated about the x -axis to form a solid of revolution. Find the volume of the solid, correct to three decimal places.

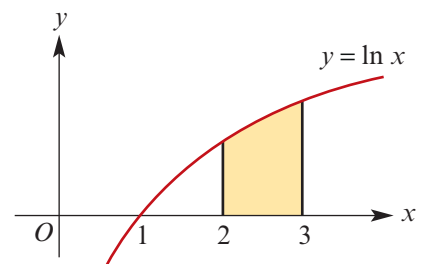

- 30** The graphs of $y = 2 \sec x$ and $y = 4$ are shown for $0 \leq x \leq \frac{\pi}{3}$.

The shaded region is rotated about the x -axis to form a solid of revolution. Calculate the exact volume of this solid.

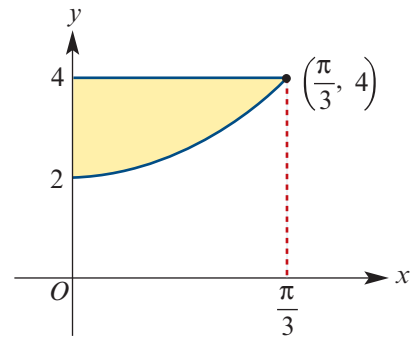

12E The exponential probability distribution

Continuous probability distributions are introduced in Mathematical Methods Year 12. In this section, we investigate the exponential probability distribution, which is often used to model the time between the occurrence of random events.

Exponential distribution

For $\lambda > 0$, an exponential random variable X with parameter λ has a probability density function given by

$$f(x) = \begin{cases} \lambda e^{-\lambda x} & \text{if } x \geq 0 \\ 0 & \text{otherwise} \end{cases}$$

The graph of $y = f(x)$ is shown on the right.

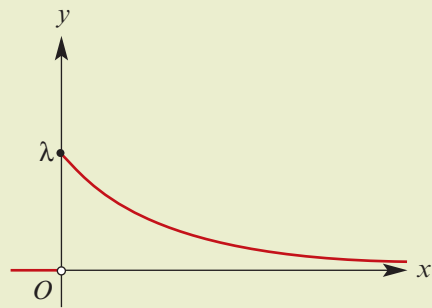

To verify that f is a probability density function, we need to show that:

- 1** $f(x) \geq 0$ for all x
- 2** the area under the graph of f is equal to 1.

The first condition is clearly satisfied. To check the second condition, we evaluate

$$\begin{aligned} \int_{-\infty}^{\infty} f(x) dx &= \int_0^{\infty} \lambda e^{-\lambda x} dx \\ &= \lim_{k \rightarrow \infty} \int_0^k \lambda e^{-\lambda x} dx \\ &= \lim_{k \rightarrow \infty} \left[-e^{-\lambda x} \right]_0^k \\ &= \lim_{k \rightarrow \infty} \left((-e^{-\lambda k}) - (-e^0) \right) \\ &= 0 + 1 \\ &= 1 \end{aligned}$$

Thus f satisfies the two conditions for a probability density function.

We can use the probability density function f to determine probabilities associated with an exponential random variable, as shown in the following example.

Example 21

The time, X minutes, that a shop assistant waits before the next customer arrives is known to be exponentially distributed, with probability density function given by

$$f(x) = \begin{cases} 0.2e^{-0.2x} & x \geq 0 \\ 0 & x < 0 \end{cases}$$

Find the probability that he will wait more than 8 minutes for the next customer to arrive.

Solution

$$\begin{aligned} \Pr(X > 8) &= \int_8^{\infty} 0.2e^{-0.2x} dx \\ &= \lim_{k \rightarrow \infty} \left[-e^{-0.2x} \right]_8^k \\ &= e^{-1.6} \\ &\approx 0.2019 \end{aligned}$$

The mean and standard deviation of an exponential random variable

Let X be an exponentially distributed random variable with parameter λ . We can find the expected value of X using integration by parts:

$$\begin{aligned} E(X) &= \int_{-\infty}^{\infty} x \cdot f(x) dx \\ &= \int_0^{\infty} x \cdot \lambda e^{-\lambda x} dx \\ &= \lim_{k \rightarrow \infty} \left(\left[-xe^{-\lambda x} \right]_0^k - \int_0^k -e^{-\lambda x} dx \right) \quad \text{use } u = x \text{ and } v = -e^{-\lambda x} \\ &= \lim_{k \rightarrow \infty} \left(-ke^{-\lambda k} - \left[\frac{1}{\lambda} e^{-\lambda x} \right]_0^k \right) \\ &= \frac{1}{\lambda} \quad \text{since } \lim_{k \rightarrow \infty} ke^{-\lambda k} = 0 \end{aligned}$$

To find the standard deviation of X , we first need to find $E(X^2)$. This time we use integration by parts twice:

$$\begin{aligned} E(X^2) &= \int_{-\infty}^{\infty} x^2 \cdot f(x) dx \\ &= \int_0^{\infty} x^2 \cdot \lambda e^{-\lambda x} dx \\ &= \lim_{k \rightarrow \infty} \left[-x^2 e^{-\lambda x} - \frac{2}{\lambda} x e^{-\lambda x} - \frac{2}{\lambda^2} e^{-\lambda x} \right]_0^k \\ &= \frac{2}{\lambda^2} \end{aligned}$$

Therefore $\text{Var}(X) = E(X^2) - [E(X)]^2 = \frac{1}{\lambda^2}$ and so $\text{sd}(X) = \sqrt{\text{Var}(X)} = \frac{1}{\lambda}$.

Mean and standard deviation of an exponential random variable

For an exponentially distributed random variable X with parameter λ :

$$E(X) = \frac{1}{\lambda} \quad \text{and} \quad \text{sd}(X) = \frac{1}{\lambda}$$

Example 22

For the situation in Example 21, find the mean and standard deviation of the time that the shop assistant waits for a customer.

Solution

$$E(X) = \frac{1}{\lambda} = \frac{1}{0.2} = 5 \text{ minutes}$$

$$\text{sd}(X) = \frac{1}{\lambda} = \frac{1}{0.2} = 5 \text{ minutes}$$

Example 23

The time, T minutes, that it takes a librarian to locate a book is exponentially distributed with a mean of 3 minutes. Find:

- a** the probability density function of T
- b** the probability that it takes her less than 2 minutes to find a book.

Solution

- a** Since T is exponentially distributed, we have $f(t) = \lambda e^{-\lambda t}$ for $t \geq 0$.

We are given that $E(T) = \frac{1}{\lambda} = 3$ and therefore $\lambda = \frac{1}{3}$.

Hence $f(t) = \frac{1}{3}e^{-\frac{t}{3}}$ for $t \geq 0$.

- b** $\Pr(T < 2) = \int_0^2 \frac{1}{3}e^{-\frac{t}{3}} dt$
- $$= \left[-e^{-\frac{t}{3}} \right]_0^2$$
- $$= 1 - e^{-\frac{2}{3}}$$
- $$\approx 0.4866$$

The cumulative distribution function of an exponential random variable

Again, let X be an exponentially distributed random variable with parameter λ . For $x \geq 0$, the cumulative distribution function of X is given by

$$\begin{aligned} F(x) &= \Pr(X \leq x) = \int_0^x \lambda e^{-\lambda t} dt \\ &= \left[-e^{-\lambda t} \right]_0^x \\ &= 1 - e^{-\lambda x} \end{aligned}$$

Cumulative distribution for an exponential random variable

For an exponentially distributed random variable X with parameter λ :

$$F(x) = \Pr(X \leq x) = \begin{cases} 1 - e^{-\lambda x} & \text{if } x \geq 0 \\ 0 & \text{otherwise} \end{cases}$$

Example 24

For the situation in Example 21, find the cumulative distribution function of X , and hence find the probability that the shop assistant waits between 5 and 10 minutes for a customer.

Solution

Since $\lambda = 0.2$, we have $F(x) = 1 - e^{-0.2x}$ for $x \geq 0$. Therefore

$$\begin{aligned} \Pr(5 \leq X \leq 10) &= \Pr(X \leq 10) - \Pr(X < 5) \\ &= F(10) - F(5) \\ &= (1 - e^{-2}) - (1 - e^{-1}) \\ &\approx 0.2325 \end{aligned}$$

Exercise 12E**Example 21**

1 Let X be an exponential random variable with probability density function

$$f(x) = \begin{cases} 0.5e^{-0.5x} & x \geq 0 \\ 0 & x < 0 \end{cases}$$

- a** Find $\Pr(X > 1)$. **b** Find $\Pr(X < 2)$.

2 Suppose that X is an exponential random variable with probability density function

$$f(x) = \begin{cases} \frac{1}{7}e^{-\frac{x}{7}} & \text{if } x \geq 0 \\ 0 & \text{otherwise} \end{cases}$$

- a** Find $\Pr(X > 3)$. **b** Find $\Pr(7 < X < 14)$.

Example 22

3 Suppose that X is an exponentially distributed random variable with probability density function given by

$$f(x) = \begin{cases} 0.1e^{-0.1x} & x \geq 0 \\ 0 & x < 0 \end{cases}$$

- a** Find $E(X)$ and $\text{sd}(X)$. **b** Find $\Pr(X > E(X))$.

Example 23

4 Customers at a checkout wait on average 6 minutes to be served. If the time, T minutes, that a customer waits to be served is exponentially distributed, find:

- a** the probability density function of T
b the probability that a customer waits less than 3 minutes to be served
c the probability that a customer waits more than 10 minutes to be served, given that they have already waited 5 minutes.

5 The time, X seconds, that it takes to locate a card in a file of records has an exponential distribution with a mean of 20 seconds. Find:

- a** $\Pr(X \leq 30)$ **b** $\Pr(X \geq 20)$ **c** $\Pr(20 \leq X \leq 30)$

- 6** The lifetime of a certain kind of battery is an exponential random variable with a mean of 250 hours. What is the probability that such a battery will last at most 200 hours?
- 7** The time (in hours) required to repair a machine is an exponentially distributed random variable with mean 1.5 hours.
- a** What is the probability that a repair takes more than 2 hours?
- b** What is the probability that a repair takes at least 10 hours, given that it takes at least 9 hours?
- 8** The random variable X represents the time (in minutes) between the arrival of customers at an ATM. If X has an exponential distribution with parameter $\lambda = 0.2$, determine:
- a** the expected time between two successive arrivals
- b** the standard deviation of the time between successive arrivals
- c** the probability $\Pr(X \leq 2.5)$.
- 9** Suppose that X is an exponentially distributed random variable with mean 0.5.
- a** Find $\Pr(X > 2)$. **b** Find $\text{Var}(X)$. **c** Find $\Pr(X > 2 | X < 3)$.

Example 24

- 10** Let X be an exponentially distributed random variable with parameter $\lambda = \frac{1}{4}$.

- a** Find the cumulative distribution function $F(x) = \Pr(X \leq x)$.
- b** Hence find the median of X . That is, find m such that $\Pr(X \leq m) = 0.5$.
- 11** Lacey receives four phone calls per hour on average. If the time between phone calls is exponentially distributed, find the probability that she will wait no longer than 10 minutes for her next phone call.
- 12** Suppose that the length of time that an electric light bulb lasts, X hours, is an exponential random variable with cumulative distribution function given by

$$F(x) = 1 - e^{-\frac{x}{500}} \quad \text{for } x \geq 0$$

Find:

- a** the probability that a bulb lasts more than 300 hours
- b** the mean lifetime of a bulb
- c** the median lifetime of a bulb.
- 13** The time (in minutes) between telephone calls received at a pizza restaurant is exponentially distributed with a mean of 4 minutes. Find the median time between calls.
- 14** Suppose that the amount of time that customers spend in a bank is exponentially distributed with a mean of 10 minutes.
- a** What is the probability that a customer will spend more than 15 minutes in the bank?
- b** What is the probability that a customer will spend more than 15 minutes in the bank, given that she is still in the bank after 10 minutes?



Chapter summary



Fundamental theorem of calculus

- If f is a continuous function on an interval $[a, b]$, then $\int_a^b f(x) dx = F(b) - F(a)$, where F is any antiderivative of f .
- If f is a continuous function and the function G is defined by $G(x) = \int_a^x f(t) dt$, then G is an antiderivative of f .

Areas of regions between curves

- If f and g are continuous functions such that $f(x) \geq g(x)$ for all $x \in [a, b]$, then the area of the region bounded by the curves and the lines $x = a$ and $x = b$ is given by

$$\int_a^b f(x) - g(x) dx$$

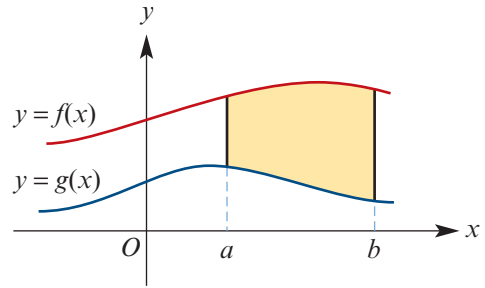

- For graphs that cross, consider intervals. For example, the area of the shaded region is given by

$$\int_a^{c_1} f(x) - g(x) dx + \int_{c_1}^{c_2} g(x) - f(x) dx + \int_{c_2}^{c_3} f(x) - g(x) dx + \int_{c_3}^b g(x) - f(x) dx$$

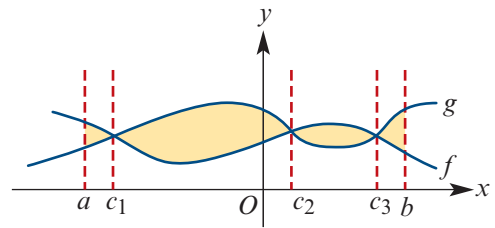

Volumes of solids of revolution

- **Region bounded by the x -axis** If the region to be rotated about the x -axis is bounded by the curve with equation $y = f(x)$, the lines $x = a$ and $x = b$ and the x -axis, then the volume V is given by

$$V = \int_a^b \pi y^2 dx = \pi \int_a^b (f(x))^2 dx$$

- **Region not bounded by the x -axis** If the shaded region is rotated about the x -axis, then the volume V is given by

$$V = \pi \int_a^b (f(x))^2 - (g(x))^2 dx$$

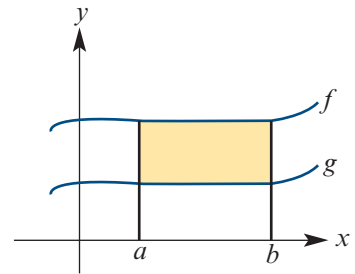

Exponential distribution

- For $\lambda > 0$, an exponential random variable X with parameter λ has a probability density function given by

$$f(x) = \begin{cases} \lambda e^{-\lambda x} & \text{if } x \geq 0 \\ 0 & \text{otherwise} \end{cases}$$

The mean and standard deviation of X are given by

$$E(X) = \frac{1}{\lambda} \quad \text{and} \quad \text{sd}(X) = \frac{1}{\lambda}$$

Short-answer questions

- 1** Calculate the area of the region enclosed by the graph of $y = \frac{x}{\sqrt{x-2}}$ and the line $y = 3$.
- 2 a** If $y = 1 - \cos x$, find the value of $\int_0^{\frac{\pi}{2}} y \, dx$. On a sketch graph, indicate the region for which the area is represented by this integral.
b Hence find $\int_0^1 x \, dy$.
- 3** Find the volume of revolution of each of the following. (Rotation is about the x -axis.)
a $y = \sec x$ between $x = 0$ and $x = \frac{\pi}{4}$ **b** $y = \sin x$ between $x = 0$ and $x = \frac{\pi}{4}$
c $y = \cos x$ between $x = 0$ and $x = \frac{\pi}{4}$ **d** the region between $y = x^2$ and $y = 4x$
e $y = \sqrt{1+x}$ between $x = 0$ and $x = 8$
- 4** Find the volume generated when the region bounded by the curve $y = 1 + \sqrt{x}$, the x -axis and the lines $x = 1$ and $x = 4$ is rotated about the x -axis.
- 5** The region S in the first quadrant of the Cartesian plane is bounded by the axes, the line $x = 3$ and the curve $y = \sqrt{1+x^2}$. Find the volume of the solid formed when S is rotated:
a about the x -axis **b** about the y -axis.
- 6** Sketch the graph of $y = \sec x$ for $x \in \left(\frac{-\pi}{2}, \frac{\pi}{2}\right)$. Find the volume of the solid of revolution obtained by rotating this curve about the x -axis for $x \in \left[\frac{-\pi}{4}, \frac{\pi}{4}\right]$.
- 7 a** Find the coordinates of the points of intersection of the graphs of $y^2 = 8x$ and $y = 2x$.
b Find the volume of the solid formed when the area enclosed by these graphs is rotated about the x -axis.
- 8 a** On the one set of axes, sketch the graphs of $y = 1 - x^2$ and $y = x - x^3 = x(1 - x^2)$. (Turning points of the second graph do not have to be determined.)
b Find the area of the region enclosed between the two graphs.
- 9** The curves $y = x^2$ and $x^2 + y^2 = 2$ meet at the points A and B .
a Find the coordinates of A , B and C .
b Find the volume of the solid of revolution formed by rotating the shaded region about the x -axis.

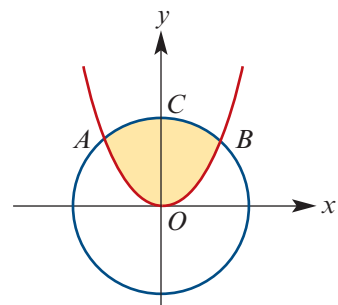

- 10 a** Sketch the graph of $y = 2x - x^2$ for $y \geq 0$.
- b** Find the area of the region enclosed between this curve and the x -axis.
- c** Find the volume of the solid of revolution formed by rotating this region about the x -axis.
- 11 a** Let the curve $f: [0, b] \rightarrow \mathbb{R}$, $f(x) = x^2$ be rotated:
- i** around the x -axis to define a solid of revolution, and find the volume of this solid in terms of b (where the region rotated is between the curve and the x -axis)
- ii** around the y -axis to define a solid of revolution, and find the volume of this solid in terms of b (where the region rotated is between the curve and the y -axis).
- b** For what value of b are the two volumes equal?
- 12 a** Sketch the graph of $\left\{ (x, y) : y = \frac{1}{4x^2 + 1} \right\}$.
- b** Find $\frac{dy}{dx}$ and hence find the equation of the tangent to this curve at $x = \frac{1}{2}$.
- c** Find the area of the region bounded by the curve and the tangent to the curve at $x = \frac{1}{2}$.
- 13** Let $f: \mathbb{R} \rightarrow \mathbb{R}$, $f(x) = x$ and $g: \mathbb{R} \setminus \{0\} \rightarrow \mathbb{R}$, $g(x) = \frac{9}{x}$.
- a** Sketch, on the same set of axes, the graphs of $f + g$ and $f - g$.
- b** Find the area of the region bounded by the two graphs sketched in **a** and the lines $x = 1$ and $x = 3$.
- 14** Sketch the graph of $\left\{ (x, y) : y = x - 5 + \frac{4}{x} \right\}$. Find the area of the region bounded by this curve and the x -axis.
- 15** Sketch the graph of $\left\{ (x, y) : y = \frac{1}{2 + x - x^2} \right\}$. Find the area of the region bounded by this graph and the line $y = \frac{1}{2}$.

- 16** The probability density function of an exponentially distributed random variable X is given by

$$f(x) = \begin{cases} 2e^{-2x} & x \geq 0 \\ 0 & x < 0 \end{cases}$$

Find the exact value of $\Pr(X > 1)$.

- 17** Suppose that X is an exponential random variable with probability density function

$$f(x) = \begin{cases} \frac{1}{8}e^{-\frac{x}{8}} & \text{if } x \geq 0 \\ 0 & \text{otherwise} \end{cases}$$

- a** Find the cumulative distribution function of X .
- b** Hence determine the exact value of the median of X .



Multiple-choice questions



1 The volume of the solid of revolution formed when the region bounded by the axes, the line $x = 1$ and the curve with equation $y = \frac{1}{\sqrt{4-x^2}}$ is rotated about the x -axis is

- A $\frac{\pi^2}{6}$ B $\frac{\pi^2}{3}$ C $\frac{\pi}{4} \ln(3)$ D $\pi\sqrt{3} \ln(3)$ E $\frac{2\pi^2}{3}$

2 The shaded region shown below is enclosed by the curve $y = \frac{6}{\sqrt{5+x^2}}$, the straight line $y = 2$ and the y -axis. The region is rotated about the x -axis to form a solid of revolution. The volume of this solid, in cubic units, is given by

- A $\pi \int_0^2 \left(\frac{6}{\sqrt{5+x^2}} - 2 \right)^2 dx$
 B $6\pi \tan^{-1}\left(\frac{2}{5}\right)$
 C $\frac{36\pi}{\sqrt{5}} \tan^{-1}\left(\frac{2}{\sqrt{5}}\right)$
 D $\pi \int_0^2 \left(\frac{6}{\sqrt{5+x^2}} \right)^2 - 4 dx$
 E 36π

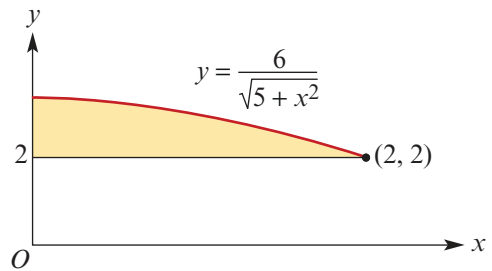

3 The graphs of $y = \sin^2 x$ and $y = \frac{1}{2} \cos(2x)$ are shown in the diagram. The total area of the shaded regions is equal to

- A $\int_0^{2\pi} \sin^2 x - \frac{1}{2} \cos(2x) dx$
 B $4 \int_0^{\frac{\pi}{6}} \frac{1}{2} \cos(2x) - \sin^2 x dx$
 $+ 2 \int_{\frac{\pi}{6}}^{\frac{5\pi}{6}} \sin^2 x - \frac{1}{2} \cos(2x) dx$
 C 3.14
 D π
 E $\frac{\sqrt{3}}{2} + \frac{\pi}{3}$

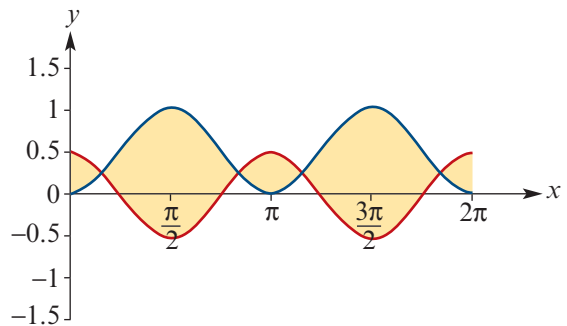

4 If X is an exponentially distributed random variable with a mean of 4, then $\Pr(X < 2)$ is closest to

- A 0.6065 B 0.3935 C 0.1516 D 0.3023 E 0.7868

5 A help desk receives an average of 10 queries per hour. If the time between receiving queries is exponentially distributed, then the probability that it will be more than 10 minutes until the next query is equal to

- A e^{-1} B $e^{-\frac{5}{3}}$ C e^{-60} D $1 - e^{-1}$ E $1 - e^{-\frac{5}{3}}$

- 6 Let X be an exponentially distributed random variable with a mean of 0.5. For $x \geq 0$, the probability density function of X is given by

A $f(x) = 2e^{-2x}$ **B** $f(x) = 0.5e^{-2x}$ **C** $f(x) = 1 - 0.5e^{-\frac{x}{2}}$

D $f(x) = 0.5e^{-\frac{x}{2}}$ **E** $f(x) = 0.5e^{\frac{x}{2}}$

- 7 Let X be an exponentially distributed random variable with a mean of 4. For $x \geq 0$, the cumulative distribution function of X is given by

A $F(x) = 1 - 0.25e^{-0.25x}$ **B** $F(x) = 1 - 4e^{-4x}$ **C** $F(x) = 1 - e^{-4x}$

D $F(x) = 0.25e^{-0.25x}$ **E** $F(x) = 1 - e^{-0.25x}$

- 8 The shaded region in the diagram is bounded by the lines $x = e^2$ and $x = e^3$, the x -axis and the graph of $y = \ln x$. The volume of the solid of revolution formed by rotating this region about the x -axis is equal to

A $\pi \int_2^3 e^{2x} dx$

B $\pi \int_7^{20} (\ln x)^2 dx$

C $\pi \int_{e^2}^{e^3} (\ln x)^2 dx$

D $\pi(e^3 - e^2)$

E $\pi^2 \int_{e^2}^{e^3} (\ln x)^2 dx$

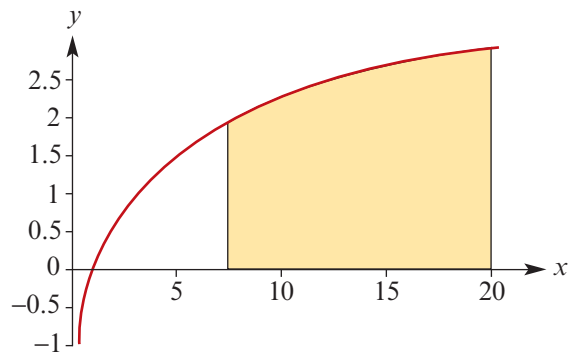

- 9 The graph represents the function $y = \sin x$ where $0 \leq x \leq 2\pi$. The total area of the shaded regions is

A $1 - \cos a$

B $-2 \sin a$

C $2(1 - \cos a)$

D 0

E $-2(1 - \cos a)$

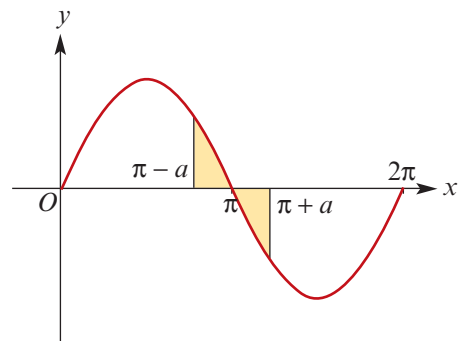

- 10 The area of the region enclosed between the curve with equation $y = \sin^3 x$, $x \in [0, a]$, the x -axis and the line with equation $x = a$, where $0 < a < \frac{\pi}{2}$, is

A $3 \cos^2 a$ **B** $\frac{2}{3} - \frac{1}{3} \sin^3 a$ **C** $\left(\frac{2}{3} - \frac{1}{3} \sin^2 a\right) \cos a + \frac{2}{3}$

D $\frac{1}{3} \cos^3 a \sin a$ **E** $\frac{2}{3} - \cos a + \frac{1}{3} \cos^3 a$

- 11** The shaded region shown is rotated around the x -axis to form a solid of revolution. The volume of the solid of revolution is

- A** $1 - \ln\left(\frac{1}{3}\right)$
- B** $\pi(\ln 3 - 1)$
- C** 0.099
- D** $\pi(-1 + \ln\left(\frac{1}{3}\right))$
- E** 0.1

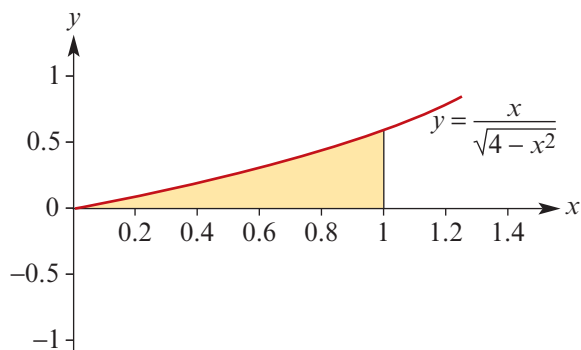

- 12** The shaded region shown in the diagram is rotated around the x -axis to form a solid of revolution, where $f'(x) > 0$ and $f''(x) > 0$ for all $x \in [a, b]$ and the volume of the solid of revolution is V cubic units. Which of the following statements is false?

- A** $V < \pi(f(b))^2(b - a)$
- B** $V > \pi(f(a))^2(b - a)$
- C** $V = \pi \int_a^b (f(x))^2 dx$
- D** $V = \pi \left((F(b))^2 - (F(a))^2 \right)$,
where $F'(x) = f(x)$
- E** $V < \pi \left((f(b))^2 b - (f(a))^2 a \right)$

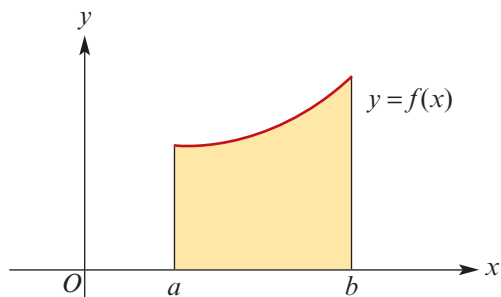

- 13** The area of the region bounded by the curve $y = \cos\left(\frac{x}{2}\right)$, the x -axis and the lines $x = 0$ and $x = \pi$ is

- A** 0
- B** 1
- C** 2
- D** π
- E** 4

- 14** The region bounded by the coordinate axes and the graph of $y = \cos x$, for $0 \leq x \leq \frac{\pi}{2}$, is rotated about the y -axis to form a solid of revolution. The volume of the solid is given by

- A** $\pi \int_0^1 \cos^2 x dx$
- B** $\pi \int_0^{\frac{\pi}{2}} \cos^2 x dx$
- C** $\pi \int_0^1 \cos^{-1} y dx$
- D** $\pi \int_0^{\frac{\pi}{2}} (\cos^{-1} y)^2 dy$
- E** $\pi \int_0^1 (\cos^{-1} y)^2 dy$



Extended-response questions

- 1 a** Sketch the curve with equation $y = 1 - \frac{1}{x+2}$.
- b** Find the area of the region bounded by the x -axis, the curve and the lines $x = 0$ and $x = 2$.
- c** Find the volume of the solid of revolution formed when this region is rotated around the x -axis.

2 Let $f: \mathbb{R} \rightarrow \mathbb{R}$, $f(x) = x \tan^{-1} x$.

a Find $f'(x)$.

b Hence find $\int_0^1 \tan^{-1} x \, dx$.

c Use the result of **b** to find the area of the region bounded by $y = \tan^{-1} x$, $y = \frac{\pi}{4}$ and the y -axis.

d Let $g: \mathbb{R} \rightarrow \mathbb{R}$, $g(x) = (\tan^{-1} x)^2$.

i Find $g'(x)$.

ii Show that $g'(x) > 0$ for $x > 0$.

iii Sketch the graph of $g: \mathbb{R} \rightarrow \mathbb{R}$, $g(x) = (\tan^{-1} x)^2$.

e Find the volume of the solid of revolution formed when the shaded region shown is rotated around the y -axis.

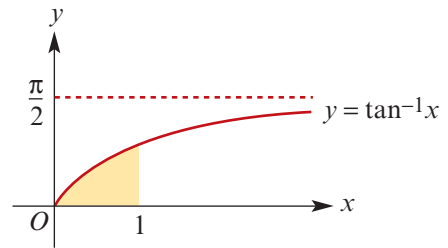

3 a i Differentiate $x \ln x$ and hence find $\int \ln x \, dx$.

ii Differentiate $x(\ln x)^2$ and hence find $\int (\ln x)^2 \, dx$.

b Sketch the graph of $f: [-2, 2] \rightarrow \mathbb{R}$,

$$f(x) = \begin{cases} e^x & x \in [0, 2] \\ e^{-x} & x \in [-2, 0) \end{cases}$$

c The interior of a wine glass is formed by rotating the curve $y = e^x$ from $x = 0$ to $x = 2$ about the y -axis. If the units are in centimetres find, correct to two significant figures, the volume of liquid that the glass contains when full.

4 The lifetime of an electronic component, T years, is an exponentially distributed random variable with probability density function given by

$$f(t) = \begin{cases} e^{-t} & t \geq 0 \\ 0 & t < 0 \end{cases}$$

a Find $\Pr(T > 2)$.

b Find $\Pr(T > 2 \mid T < 3)$.

c Find the mean, μ , and the standard deviation, σ , of T . Hence evaluate

$$\Pr(\mu - 2\sigma < T < \mu + 2\sigma)$$

d Find the lifetime, L years, which a typical component is 80% certain to exceed.

e If five components are sold, what is the probability that at least one of them will have a lifetime of less than L years?

- 5** A bowl is modelled by rotating the curve $y = x^2$ for $0 \leq x \leq 1$ around the y -axis.
- Find the volume of the bowl.
 - If liquid is poured into the bowl at a rate of R units of volume per second, find the rate of increase of the depth of liquid in the bowl when the depth is $\frac{1}{4}$.
Hint: Use the chain rule: $\frac{dv}{dt} = \frac{dv}{dy} \frac{dy}{dt}$.
- c**
- Find the volume of liquid in the bowl when the depth of liquid is $\frac{1}{2}$.
 - Find the depth of liquid in the bowl when it is half full.

- 6** The curves $y = ax^2$ and $y = 1 - \frac{x^2}{a}$ are shown, where $a > 0$.

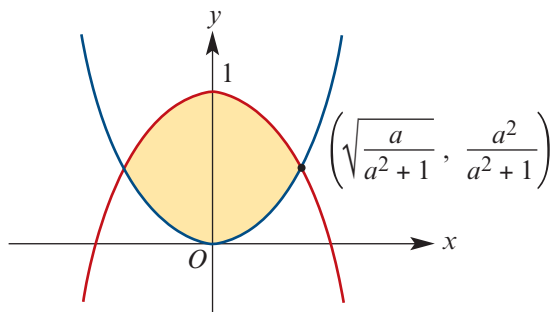

- Show that the area enclosed by the two curves is $\frac{4}{3} \sqrt{\frac{a}{a^2+1}}$.
- b**
- Find the value of a which gives the maximum area.
 - Find the maximum area.
- c** Find the volume of the solid formed when the region bounded by these curves is rotated about the y -axis.
- 7**
- On the same set of axes, sketch the graphs of $y = 3 \sec^2 x$ and $y = 16 \sin^2 x$ for $0 \leq x \leq \frac{\pi}{4}$.
 - Find the coordinates of the point of intersection of these two curves.
 - Find the area of the region bounded by the two curves and the y -axis.
- 8** Let $f: (1, \infty) \rightarrow \mathbb{R}$ be such that:
- $f'(x) = \frac{1}{x-a}$, where a is a positive constant
 - $f(2) = 1$
 - $f(1+e^{-1}) = 0$
- Find a and use it to determine $f(x)$.
 - Sketch the graph of f .
 - If f^{-1} is the inverse of f , show that $f^{-1}(x) = 1 + e^{x-1}$. Give the domain and range of f^{-1} .
 - Find the area of the region enclosed by $y = f^{-1}(x)$, the x -axis, the y -axis and the line $x = 1$.
 - Find $\int_{1+e^{-1}}^2 f(x) dx$.
- 9** The curves $cy^2 = x^3$ and $y^2 = ax$ (where $a > 0$ and $c > 0$) intersect at the origin, O , and at a point P in the first quadrant. The areas of the regions enclosed by the curves OP , the x -axis and the vertical line through P are A_1 and A_2 respectively for the two curves. The volumes of the two solids formed by rotating these regions about the x -axis are V_1 and V_2 respectively. Show that $A_1 : A_2 = 3 : 5$ and $V_1 : V_2 = 1 : 2$.

- 10** Let $f: [0, a] \rightarrow \mathbb{R}$, where $f(x) = 3 \cos(\frac{1}{2}x)$.
- a** Find the largest value of a for which f has an inverse function, f^{-1} .
 - b i** State the domain and range of f^{-1} . **ii** Find $f^{-1}(x)$. **iii** Sketch the graph of f^{-1} .
 - c** Find the gradient of the curve $y = f^{-1}(x)$ at the point where the curve crosses the y -axis.
 - d** Let V_1 be the volume of the solid of revolution formed by rotating the curve $y = f(x)$ between $x = 0$ and $x = \pi$ about the x -axis. Let V_2 be the volume of the solid of revolution formed by rotating the curve $y = f^{-1}(x)$ between $y = 0$ and $y = \pi$ about the y -axis. Find V_1 and hence find V_2 .

- 11 a** Find the area of the circle formed when a sphere is cut by a plane at a distance y from the centre, where $y < r$.
- b** By integration, prove that the volume of a 'cap' of height $\frac{1}{4}r$ cut from the top of the sphere, as shown in the diagram, is $\frac{11\pi r^3}{192}$.

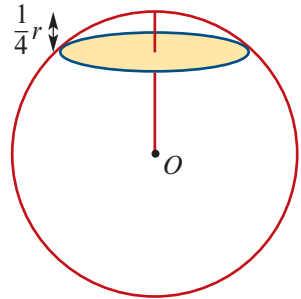

- 12** Consider the section of a hyperbola with $\frac{x^2}{a^2} - \frac{y^2}{b^2} = 1$ and $a \leq x \leq 2a$ (where $a > 0$). Find the volume of the solid formed when region bounded by the hyperbola and the line with equation $x = 2a$ is rotated about:

- a** the x -axis
 - b** the y -axis.
- 13 a** Show that the line $y = \frac{3x}{2}$ does not meet the curve $y = \frac{1}{\sqrt{1-x^2}}$.
- b** Find the area of the region bounded by the curve with equation $y = \frac{1}{\sqrt{1-x^2}}$ and the lines $y = \frac{3x}{2}$, $x = 0$ and $x = \frac{1}{2}$.
- c** Find the volume of the solid of revolution formed by rotating the region defined in **b** about the x -axis. Express your answer in the form $\pi(a + \ln b)$.

- 14 a** For $0 \leq a \leq 1$, let T_a be the triangle whose vertices are $(0, 0)$, $(1, 0)$ and $(a, 1)$. Find the volume of the solid of revolution when T_a is rotated about the x -axis.
- b** For $0 \leq k \leq 1$, let T_k be the triangle whose vertices are $(0, 0)$, $(k, 0)$ and $(0, \sqrt{1-k^2})$. The triangle T_k is rotated about the x -axis. What value of k gives the maximum volume? What is the maximum volume?

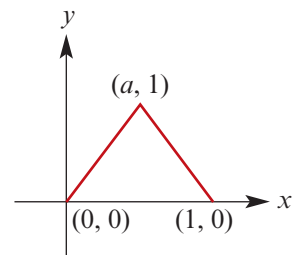

- 15** A model for a bowl is formed by rotating a section of the graph of a cubic function $f(x) = ax^3 + bx^2 + cx + d$ around the x -axis to form a solid of revolution. The cubic is chosen to pass through the points with coordinates $(0, 0)$, $(5, 1)$, $(10, 2.5)$ and $(30, 10)$.
- Write down the four simultaneous equations that can be used to determine the coefficients a, b, c and d .
 - Using a CAS calculator, or otherwise, find the values of a, b, c and d . (Exact values should be stated.)
 - Find the area of the region enclosed by the curve and the line $x = 30$.
 - Write the expression that can be used to determine the volume of the solid of revolution when the section of the curve $0 \leq x \leq 30$ is rotated around the x -axis.
 - Use a CAS calculator to determine this volume.
 - Using the initial design, the bowl is unstable. The designer is very fond of the cubic $y = f(x)$, and modifies the design so that the base of the bowl has radius 5 units. Using a CAS calculator:
 - find the value of w such that $f(w) = 5$
 - find the new volume, correct to four significant figures.
 - A mathematician looks at the design and suggests that it may be more pleasing to the eye if the base is chosen to occur at a point where $x = p$ and $f''(p) = 0$. Find the values of coordinates of the point $(p, f(p))$.

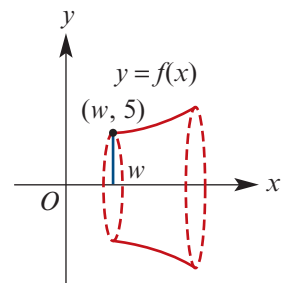

- 16** A model of a bowl is formed by rotating the line segment AB about the y -axis to form a solid of revolution.
- Find the volume, $V \text{ cm}^3$, of the bowl in terms of a, b and H . (Units are centimetres.)
 - If the bowl is filled with water to a height $\frac{H}{2}$, find the volume of water.
 - Find an expression for the volume of water in the bowl when the radius of the water surface is $r \text{ cm}$. (The constants a, b and H are to be used.)
 - Find $\frac{dV}{dr}$.
 - Find an expression for the depth of the water, $h \text{ cm}$, in terms of r .
 - Now assume that $a = 10$, $b = 20$ and $H = 20$.
 - Find $\frac{dV}{dr}$ in terms of r .
 - If water is being poured into the bowl at $3 \text{ cm}^3/\text{s}$, find $\frac{dr}{dt}$ and $\frac{dh}{dt}$ when $r = 12$.

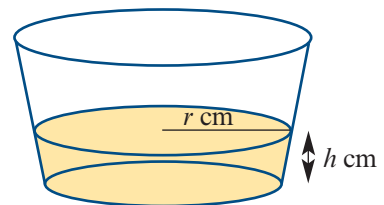
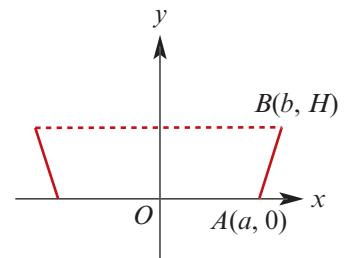

13

Differential equations

Objectives

- ▶ To **verify** a solution of a differential equation.
- ▶ To apply techniques to **solve** differential equations of the form $\frac{dy}{dx} = f(x)$ and $\frac{d^2y}{dx^2} = f(x)$.
- ▶ To apply techniques to **solve** differential equations of the form $\frac{dy}{dx} = g(y)$.
- ▶ To **construct** differential equations from a given situation.
- ▶ To **apply** differential equations to solve problems.
- ▶ To solve differential equations which can be written in the form $\frac{dy}{dx} = f(x)g(y)$ using **separation of variables**.
- ▶ To solve differential equations using a CAS calculator.
- ▶ To use **Euler's method** to obtain approximate solutions to a given differential equation.
- ▶ To construct a **slope field** for a given differential equation.

Differential equations arise when we have information about the rate of change of a quantity, rather than the quantity itself.

For example, we know that the rate of decay of a radioactive substance is proportional to the mass m of substance remaining at time t . We can write this as a differential equation:

$$\frac{dm}{dt} = -km$$

where k is a constant. What we would really like is an expression for the mass m at time t . Using techniques developed in this chapter, we will find that the general solution to this differential equation is $m = Ae^{-kt}$.

Differential equations have many applications in science, engineering and economics, and their study is a major branch of mathematics.

13A An introduction to differential equations

A differential equation contains derivatives of a particular function or variable. The following are examples of differential equations:

$$\frac{dy}{dx} = \cos x, \quad \frac{d^2y}{dx^2} - 4 \frac{dy}{dx} = 0, \quad \frac{dy}{dx} = \frac{y}{y+1}$$

The solution of a differential equation is a clear definition of the function or relation, without any derivatives involved.

For example, if $\frac{dy}{dx} = \cos x$, then $y = \int \cos x \, dx$ and so $y = \sin x + c$.

Here $y = \sin x + c$ is the **general solution** of the differential equation $\frac{dy}{dx} = \cos x$.

This example displays the main features of such solutions. Solutions of differential equations are the result of an integral, and therefore produce a family of functions.

To obtain a **particular solution**, we require further information, which is usually given as an ordered pair belonging to the function or relation. (For equations with second derivatives, we need two items of information.)

► Verifying a solution of a differential equation

We can verify that a particular expression is a solution of a differential equation by substitution. This is demonstrated in the following examples.

We will use the following notation to denote the y -value for a given x -value:

$$y(0) = 3 \text{ will mean that when } x = 0, y = 3.$$

We consider y as a function of x . This notation is useful in differential equations.

Example 1

- a** Verify that $y = Ae^x - x - 1$ is a solution of the differential equation $\frac{dy}{dx} = x + y$.
b Hence find the particular solution of the differential equation given that $y(0) = 3$.

Solution

- a** Let $y = Ae^x - x - 1$. We need to check that $\frac{dy}{dx} = x + y$.

$$\begin{aligned} \text{LHS} &= \frac{dy}{dx} \\ &= Ae^x - 1 \end{aligned}$$

$$\begin{aligned} \text{RHS} &= x + y \\ &= x + Ae^x - x - 1 \\ &= Ae^x - 1 \end{aligned}$$

Hence LHS = RHS and so $y = Ae^x - x - 1$ is a solution of $\frac{dy}{dx} = x + y$.

b $y(0) = 3$ means that when $x = 0$, $y = 3$.

Substituting in the solution $y = Ae^x - x - 1$ verified in **a**:

$$3 = Ae^0 - 0 - 1$$

$$3 = A - 1$$

$$\therefore A = 4$$

The particular solution is $y = 4e^x - x - 1$.

Example 2

Verify that $y = e^{2x}$ is a solution of the differential equation $\frac{d^2y}{dx^2} + \frac{dy}{dx} - 6y = 0$.

Solution

Let $y = e^{2x}$

Then $\frac{dy}{dx} = 2e^{2x}$

and $\frac{d^2y}{dx^2} = 4e^{2x}$

Now consider the differential equation:

$$\begin{aligned} \text{LHS} &= \frac{d^2y}{dx^2} + \frac{dy}{dx} - 6y \\ &= 4e^{2x} + 2e^{2x} - 6e^{2x} \quad (\text{from above}) \\ &= 0 \\ &= \text{RHS} \end{aligned}$$

Example 3

Verify that $y = ae^{2x} + be^{-3x}$ is a solution of the differential equation $\frac{d^2y}{dx^2} + \frac{dy}{dx} - 6y = 0$.

Solution

Let $y = ae^{2x} + be^{-3x}$

Then $\frac{dy}{dx} = 2ae^{2x} - 3be^{-3x}$

and $\frac{d^2y}{dx^2} = 4ae^{2x} + 9be^{-3x}$

$$\begin{aligned} \text{So LHS} &= \frac{d^2y}{dx^2} + \frac{dy}{dx} - 6y \\ &= (4ae^{2x} + 9be^{-3x}) + (2ae^{2x} - 3be^{-3x}) - 6(ae^{2x} + be^{-3x}) \\ &= 4ae^{2x} + 9be^{-3x} + 2ae^{2x} - 3be^{-3x} - 6ae^{2x} - 6be^{-3x} \\ &= 0 \\ &= \text{RHS} \end{aligned}$$

Example 4

Find the constants a and b if $y = e^{4x}(2x + 1)$ is a solution of the differential equation

$$\frac{d^2y}{dx^2} - a \frac{dy}{dx} + by = 0$$

Solution

Let $y = e^{4x}(2x + 1)$

Then $\frac{dy}{dx} = 4e^{4x}(2x + 1) + 2e^{4x}$
 $= 2e^{4x}(4x + 2 + 1)$
 $= 2e^{4x}(4x + 3)$

and $\frac{d^2y}{dx^2} = 8e^{4x}(4x + 3) + 4 \times 2e^{4x}$
 $= 8e^{4x}(4x + 3 + 1)$
 $= 8e^{4x}(4x + 4)$
 $= 32e^{4x}(x + 1)$

If $y = e^{4x}(2x + 1)$ is a solution of the differential equation, then

$$\frac{d^2y}{dx^2} - a \frac{dy}{dx} + by = 0$$

i.e. $32e^{4x}(x + 1) - 2ae^{4x}(4x + 3) + be^{4x}(2x + 1) = 0$

We can divide through by e^{4x} (since $e^{4x} > 0$):

$$32x + 32 - 8ax - 6a + 2bx + b = 0$$

i.e. $(32 - 8a + 2b)x + (32 - 6a + b) = 0$

Thus

$$32 - 8a + 2b = 0 \quad (1)$$

$$32 - 6a + b = 0 \quad (2)$$

Multiply (2) by 2 and subtract from (1):

$$-32 + 4a = 0$$

Hence $a = 8$ and $b = 16$.

Exercise 13A**Example 1**

1 For each of the following, verify that the given function or relation is a solution of the differential equation. Hence find the particular solution from the given information.

Differential equation	Function or relation	Added information
-----------------------	----------------------	-------------------

a $\frac{dy}{dt} = 2y + 4$	$y = Ae^{2t} - 2$	$y(0) = 2$
-----------------------------------	-------------------	------------

Differential equation	Function or relation	Added information
b $\frac{dy}{dx} = \ln x $	$y = x \ln x - x + c$	$y(1) = 3$
c $\frac{dy}{dx} = \frac{1}{y}$	$y = \sqrt{2x + c}$	$y(1) = 9$
d $\frac{dy}{dx} = \frac{y+1}{y}$	$y - \ln y+1 = x + c$	$y(3) = 0$
e $\frac{d^2y}{dx^2} = 6x^2$	$y = \frac{x^4}{2} + Ax + B$	$y(0) = 2, y(1) = 2$
f $\frac{d^2y}{dx^2} = 4y$	$y = Ae^{2x} + Be^{-2x}$	$y(0) = 3, y(\ln 2) = 9$
g $\frac{d^2x}{dt^2} + 9x = 18$	$x = A \sin(3t) + B \cos(3t) + 2$	$x(0) = 4, x\left(\frac{\pi}{2}\right) = -1$

Example 2, 3

2 For each of the following, verify that the given function is a solution of the differential equation:

- | | |
|---|---|
| a $\frac{dy}{dx} = 2y, y = 4e^{2x}$ | b $\frac{dy}{dx} = -4xy^2, y = \frac{1}{2x^2}$ |
| c $\frac{dy}{dx} = 1 + \frac{y}{x}, y = x \ln x + x$ | d $\frac{dy}{dx} = \frac{2x}{y^2}, y = \sqrt[3]{3x^2 + 27}$ |
| e $\frac{d^2y}{dx^2} - \frac{dy}{dx} - 6y = 0, y = e^{-2x} + e^{3x}$ | f $\frac{d^2y}{dx^2} - 8\frac{dy}{dx} + 16y = 0, y = e^{4x}(x+1)$ |
| g $\frac{d^2y}{dx^2} = -n^2y, y = a \sin(nx)$ | h $\frac{d^2y}{dx^2} = n^2y, y = e^{nx} + e^{-nx}$ |
| i $\frac{dy}{dx} = \frac{1+y^2}{1+x^2}, y = \frac{x+1}{1-x}$ | j $y \frac{d^2y}{dx^2} = 2\left(\frac{dy}{dx}\right)^2, y = \frac{4}{x+1}$ |

3 Assume that $\frac{dx}{dy}$ is inversely proportional to y . Given that when $x = 0, y = 2$ and when $x = 2, y = 4$, find y when $x = 3$.

Example 4

- 4** If the differential equation $x^2 \frac{d^2y}{dx^2} - 2x \frac{dy}{dx} - 10y = 0$ has a solution $y = ax^n$, find the possible values of n .
- 5** Find the constants a, b and c if $y = a + bx + cx^2$ is a solution of the differential equation $\frac{d^2y}{dx^2} + 2\frac{dy}{dx} + 4y = 4x^2$.
- 6** Find the constants a and b if $x = t(a \cos(2t) + b \sin(2t))$ is a solution of the differential equation $\frac{d^2x}{dt^2} + 4x = 2 \cos(2t)$.
- 7** Find the constants a, b, c and d if $y = ax^3 + bx^2 + cx + d$ is a solution to the differential equation $\frac{d^2y}{dx^2} + 2\frac{dy}{dx} + y = x^3$.



13B Differential equations involving a function of the independent variable

In this section we solve differential equations of the following two forms:

$$\frac{dy}{dx} = f(x) \quad \text{and} \quad \frac{d^2y}{dx^2} = f(x)$$

► Solving differential equations of the form $\frac{dy}{dx} = f(x)$

The simplest differential equations are those of the form

$$\frac{dy}{dx} = f(x)$$

Such a differential equation can be solved provided an antiderivative of $f(x)$ can be found.

If $\frac{dy}{dx} = f(x)$, then $y = \int f(x) dx$.

Example 5

Find the general solution of each of the following:

a $\frac{dy}{dx} = x^4 - 3x^2 + 2$

b $\frac{dy}{dt} = \sin(2t)$

c $\frac{dx}{dt} = e^{-3t} + \frac{1}{t}$

d $\frac{dx}{dy} = \frac{1}{1+y^2}$

Solution

a $\frac{dy}{dx} = x^4 - 3x^2 + 2$

$$\therefore y = \int x^4 - 3x^2 + 2 dx$$

$$\therefore y = \frac{x^5}{5} - x^3 + 2x + c$$

b $\frac{dy}{dt} = \sin(2t)$

$$\therefore y = \int \sin(2t) dt$$

$$\therefore y = -\frac{1}{2} \cos(2t) + c$$

c $\frac{dx}{dt} = e^{-3t} + \frac{1}{t}$

$$\therefore x = \int e^{-3t} + \frac{1}{t} dt$$

$$\therefore x = -\frac{1}{3}e^{-3t} + \ln|t| + c$$

d $\frac{dx}{dy} = \frac{1}{1+y^2}$

$$\therefore x = \int \frac{1}{1+y^2} dy$$

$$\therefore x = \tan^{-1}(y) + c$$

This can also be written as $y = \tan(x - c)$.

Using the TI-Nspire

- a Use **menu** > **Calculus** > **Differential Equation Solver** and complete as shown.

Note: Access the differentiation symbol (') using **ctrl** **()** or **(π)**.

- d ■ Use **menu** > **Calculus** > **Differential Equation Solver** and complete as shown.

Note: This differential equation is of the form $\frac{dx}{dy} = f(y)$, so the roles of the variables x and y are reversed.

- Solve for y in terms of x .

Using the Casio ClassPad

- a ■ In $\sqrt{\alpha}$, enter and highlight the differential equation $y' = x^4 - 3x^2 + 2$.

Note: The differentiation symbol (') is found in the **Math3** keyboard.

- Select **Interactive** > **Advanced** > **dSolve**.
- Enter x for the *Independent variable* and y for the *Dependent variable*. Tap **OK**.

- d ■ In $\sqrt{\alpha}$, enter and highlight the differential equation $x' = \frac{1}{1+y^2}$.

- Select **Interactive** > **Advanced** > **dSolve**.
- Enter y for the *Independent variable* and x for the *Dependent variable*. Tap **OK**.
- Solve for y in terms of x .

► Families of solution curves

Solving a differential equation requires finding an equation that connects the variables, but does not contain a derivative. There are no specific values for the variables. By solving differential equations, it is possible to determine what function or functions might model a particular situation or physical law.

If $\frac{dy}{dx} = x$, then it follows that $y = \frac{1}{2}x^2 + k$, where k is a constant.

The **general solution** of the differential equation $\frac{dy}{dx} = x$ can be given as $y = \frac{1}{2}x^2 + k$.

If different values of the constant k are taken, then a family of curves is obtained. This differential equation represents the family of curves $y = \frac{1}{2}x^2 + k$, where $k \in \mathbb{R}$.

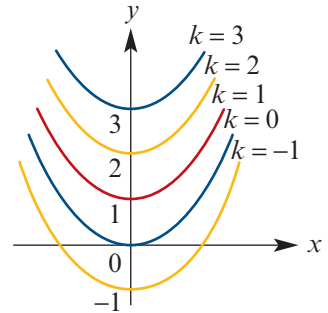

For **particular solutions** of a differential equation, a particular curve from the family can be distinguished by selecting a specific point of the plane through which the curve passes.

For instance, the particular solution of $\frac{dy}{dx} = x$ for which $y = 2$ when $x = 4$ can be thought of as the solution curve of the differential equation that passes through the point $(4, 2)$.

From above:

$$\begin{aligned} y &= \frac{1}{2}x^2 + k \\ \therefore 2 &= \frac{1}{2} \times 16 + k \\ 2 &= 8 + k \\ \therefore k &= -6 \end{aligned}$$

Thus the solution is $y = \frac{1}{2}x^2 - 6$.

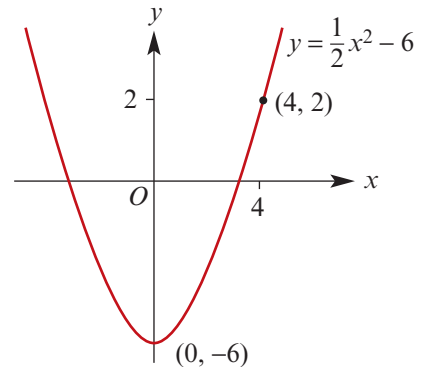

Example 6

- Find the family of curves with gradient given by e^{2x} . That is, find the general solution of the differential equation $\frac{dy}{dx} = e^{2x}$.
- Find the equation of the curve that has gradient e^{2x} and passes through $(0, 3)$.

Solution

$$\begin{aligned} \text{a } \frac{dy}{dx} &= e^{2x} \\ \therefore y &= \int e^{2x} dx \\ &= \frac{1}{2}e^{2x} + c \end{aligned}$$

The general solution $y = \frac{1}{2}e^{2x} + c$ represents a family of curves, since c can take any real number value. The diagram shows some of these curves.

- b** Substituting $x = 0$ and $y = 3$ in the general equation $y = \frac{1}{2}e^{2x} + c$, we have

$$3 = \frac{1}{2}e^0 + c$$

$$\therefore c = \frac{5}{2}$$

The equation is $y = \frac{1}{2}e^{2x} + \frac{5}{2}$.

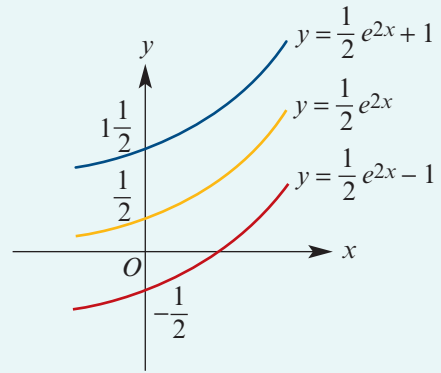

► Solving differential equations of the form $\frac{d^2y}{dx^2} = f(x)$

These differential equations are similar to those discussed above, with antidifferentiation being applied twice.

Let $p = \frac{dy}{dx}$. Then $\frac{d^2y}{dx^2} = \frac{dp}{dx} = f(x)$.

The technique involves first finding p as the solution of the differential equation $\frac{dp}{dx} = f(x)$, and then substituting p into $\frac{dy}{dx} = p$ and solving this differential equation.

Example 7

Find the general solution of each of the following:

a $\frac{d^2y}{dx^2} = 10x^3 - 3x + 4$

b $\frac{d^2y}{dx^2} = \cos(3x)$

c $\frac{d^2y}{dx^2} = e^{-x}$

d $\frac{d^2y}{dx^2} = \frac{1}{\sqrt{x+1}}$

Solution

a Let $p = \frac{dy}{dx}$.

Then $\frac{dp}{dx} = 10x^3 - 3x + 4$

$$\therefore p = \frac{5x^4}{2} - \frac{3x^2}{2} + 4x + c$$

$$\therefore \frac{dy}{dx} = \frac{5x^4}{2} - \frac{3x^2}{2} + 4x + c$$

$$\therefore y = \frac{x^5}{2} - \frac{x^3}{2} + 2x^2 + cx + d, \quad \text{where } c, d \in \mathbb{R}$$

$$\mathbf{b} \quad \frac{d^2y}{dx^2} = \cos(3x)$$

$$\text{Let } p = \frac{dy}{dx}. \text{ Then } \frac{dp}{dx} = \cos(3x).$$

$$\begin{aligned} \text{Thus } p &= \int \cos(3x) \, dx \\ &= \frac{1}{3} \sin(3x) + c \end{aligned}$$

$$\therefore \frac{dy}{dx} = \frac{1}{3} \sin(3x) + c$$

$$\begin{aligned} \therefore y &= \int \frac{1}{3} \sin(3x) + c \, dx \\ &= -\frac{1}{9} \cos(3x) + cx + d, \quad \text{where } c, d \in \mathbb{R} \end{aligned}$$

The p substitution can be omitted:

$$\mathbf{c} \quad \frac{d^2y}{dx^2} = e^{-x}$$

$$\begin{aligned} \therefore \frac{dy}{dx} &= \int e^{-x} \, dx \\ &= -e^{-x} + c \end{aligned}$$

$$\begin{aligned} \therefore y &= \int -e^{-x} + c \, dx \\ &= e^{-x} + cx + d \quad (c, d \in \mathbb{R}) \end{aligned}$$

$$\mathbf{d} \quad \frac{d^2y}{dx^2} = \frac{1}{\sqrt{x+1}}$$

$$\begin{aligned} \therefore \frac{dy}{dx} &= \int (x+1)^{-\frac{1}{2}} \, dx \\ &= 2(x+1)^{\frac{1}{2}} + c \end{aligned}$$

$$\begin{aligned} \therefore y &= \int 2(x+1)^{\frac{1}{2}} + c \, dx \\ &= \frac{4}{3}(x+1)^{\frac{3}{2}} + cx + d \quad (c, d \in \mathbb{R}) \end{aligned}$$

Example 8

Consider the differential equation $\frac{d^2y}{dx^2} = \cos^2 x$.

a Find the general solution.

b Find the solution given that $\frac{dy}{dx} = 0$ when $x = 0$ and that $y(0) = -\frac{1}{8}$.

Solution

$$\mathbf{a} \quad \text{Now } \frac{d^2y}{dx^2} = \cos^2 x$$

$$\therefore \frac{dy}{dx} = \int \cos^2 x \, dx$$

Use the trigonometric identity $\cos(2x) = 2 \cos^2 x - 1$:

$$\begin{aligned}\frac{dy}{dx} &= \int \cos^2 x \, dx \\ &= \int \frac{1}{2}(\cos(2x) + 1) \, dx \\ &= \frac{1}{4} \sin(2x) + \frac{1}{2}x + c\end{aligned}$$

$$\therefore y = \int \frac{1}{4} \sin(2x) + \frac{1}{2}x + c \, dx$$

Hence $y = -\frac{1}{8} \cos(2x) + \frac{1}{4}x^2 + cx + d$ is the general solution.

b First use $\frac{dy}{dx} = 0$ when $x = 0$. We have

$$\frac{dy}{dx} = \frac{1}{4} \sin(2x) + \frac{1}{2}x + c \quad (\text{from a})$$

$$0 = \frac{1}{4} \sin 0 + 0 + c \quad (\text{substituting given condition})$$

$$\therefore c = 0$$

$$\therefore y = -\frac{1}{8} \cos(2x) + \frac{1}{4}x^2 + d$$

Now using $y(0) = -\frac{1}{8}$, substitute and find:

$$-\frac{1}{8} = -\frac{1}{8} \cos 0 + 0 + d$$

$$\therefore d = 0$$

Hence $y = -\frac{1}{8} \cos(2x) + \frac{1}{4}x^2$ is the solution.

Using the TI-Nspire

- Use **(menu) > Calculus > Differential Equation Solver** and complete as:

$$\text{deSolve}(y'' = (\cos(x))^2 \text{ and } y(0) = \frac{-1}{8} \text{ and } y'(0) = 0, x, y)$$

- The answer can be simplified using **tCollect** (**(menu) > Algebra > Trigonometry > Collect**).

The image shows a TI-Nspire calculator screen. The top line shows the input: $\text{deSolve}(y''=(\cos(x))^2 \text{ and } y(0)=\frac{-1}{8} \text{ and } y'(0)=0)$. The output is $y = \frac{-(\cos(x))^2}{4} + \frac{x^2}{4} + \frac{1}{8}$. Below this, the **tCollect** function is used to simplify the expression, resulting in $y = \frac{x^2}{4} - \frac{\cos(2x)}{8}$.

Note: Access the differentiation symbol (') using **(ctrl) (⌘)** or **(π)**. To enter the second derivative y'' , use the differentiation symbol (') twice.

Using the Casio ClassPad

- In $\sqrt{\alpha}$, enter and highlight the differential equation $y'' = (\cos(x))^2$.
 - Select **Interactive** > **Advanced** > **dSolve**.
 - Tap *Include condition*.
 - Enter x for *Inde var* and y for *Depe var*.
 - Enter the conditions $y'(0) = 0$ and $y(0) = -1/8$.
- Note:** You must enter y using the $\boxed{\text{abc}}$ keyboard.
- Tap OK to obtain the solution.

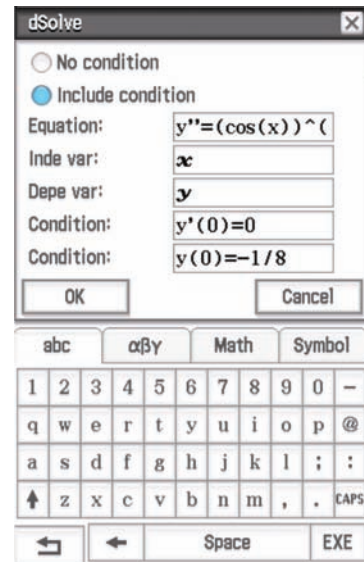
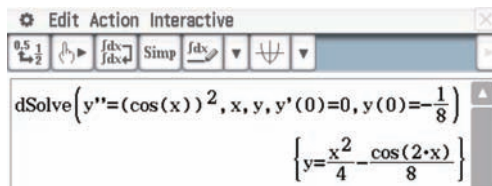

Exercise 13B

Skillsheet

- 1 Find the general solution of each of the following differential equations:

a $\frac{dy}{dx} = x^2 - 3x + 2$

b $\frac{dy}{dx} = \frac{x^2 + 3x - 1}{x}$

c $\frac{dy}{dx} = (2x + 1)^3$

d $\frac{dy}{dx} = \frac{1}{\sqrt{x}}$

e $\frac{dy}{dt} = \frac{1}{2t - 1}$

f $\frac{dy}{dt} = \sin(3t - 2)$

g $\frac{dy}{dt} = \tan(2t)$

h $\frac{dx}{dy} = e^{-3y}$

i $\frac{dx}{dy} = \frac{1}{\sqrt{4 - y^2}}$

j $\frac{dx}{dy} = -\frac{1}{(1 - y)^2}$

Example 7

- 2 Find the general solution of each of the following differential equations:

a $\frac{d^2y}{dx^2} = 5x^3$

b $\frac{d^2y}{dx^2} = \sqrt{1 - x}$

c $\frac{d^2y}{dx^2} = \sin\left(2x + \frac{\pi}{4}\right)$

d $\frac{d^2y}{dx^2} = e^{\frac{x}{2}}$

e $\frac{d^2y}{dx^2} = \frac{1}{\cos^2 x}$

f $\frac{d^2y}{dx^2} = \frac{1}{(x + 1)^2}$

Example 6

- 3 Find the solution for each of the following differential equations:

a $\frac{dy}{dx} = \frac{1}{x^2}$, given that $y = \frac{3}{4}$ when $x = 4$

b $\frac{dy}{dx} = e^{-x}$, given that $y(0) = 0$

c $\frac{dy}{dx} = \frac{x^2 - 4}{x}$, given that $y = \frac{3}{2}$ when $x = 1$

- d** $\frac{dy}{dx} = \frac{x}{x^2 - 4}$, given that $y(2\sqrt{2}) = \ln 2$
- e** $\frac{dy}{dx} = x\sqrt{x^2 - 4}$, given that $y = \frac{1}{4\sqrt{3}}$ when $x = 4$
- f** $\frac{dy}{dx} = \frac{1}{\sqrt{4 - x^2}}$, given that $y(1) = \frac{\pi}{3}$
- g** $\frac{dy}{dx} = \frac{1}{4 - x^2}$, given that $y = 2$ when $x = 0$
- h** $\frac{dy}{dx} = \frac{1}{4 + x^2}$, given that $y(2) = \frac{3\pi}{8}$
- i** $\frac{dy}{dx} = x\sqrt{4 - x}$, given that $y = -\frac{8}{15}$ when $x = 0$
- j** $\frac{dy}{dx} = \frac{e^x}{e^x + 1}$, given that $y(0) = 0$

Example 8

4 Find the solution for each of the following differential equations:

- a** $\frac{d^2y}{dx^2} = e^{-x} - e^x$, given that $y(0) = 0$ and that $\frac{dy}{dx} = 0$ when $x = 0$
- b** $\frac{d^2y}{dx^2} = 2 - 12x$, given that when $x = 0$, $y = 0$ and $\frac{dy}{dx} = 0$
- c** $\frac{d^2y}{dx^2} = 2 - \sin(2x)$, given that when $x = 0$, $y = -1$ and $\frac{dy}{dx} = \frac{1}{2}$
- d** $\frac{d^2y}{dx^2} = 1 - \frac{1}{x^2}$, given that $y(1) = \frac{3}{2}$ and that $\frac{dy}{dx} = 0$ when $x = 1$
- e** $\frac{d^2y}{dx^2} = \frac{2x}{(1 + x^2)^2}$, given that when $x = 0$, $\frac{dy}{dx} = 0$ and that when $x = 1$, $y = 1$
- f** $\frac{d^2y}{dx^2} = 24(2x + 1)$, given that $y(-1) = -2$ and that $\frac{dy}{dx} = 6$ when $x = -1$
- g** $\frac{d^2y}{dx^2} = \frac{x}{(4 - x^2)^{\frac{3}{2}}}$, given that when $x = 0$, $\frac{dy}{dx} = \frac{1}{2}$ and when $x = -2$, $y = -\frac{\pi}{2}$

5 Find the family of curves defined by each of the following differential equations:

- a** $\frac{dy}{dx} = 3x + 4$ **b** $\frac{d^2y}{dx^2} = -2x$ **c** $\frac{dy}{dx} = \frac{1}{x - 3}$

6 Find the equation of the curve defined by each of the following:

- a** $\frac{dy}{dx} = 2 - e^{-x}$, $y(0) = 1$
- b** $\frac{dy}{dx} = x + \sin(2x)$, $y(0) = 4$
- c** $\frac{dy}{dx} = \frac{1}{2 - x}$, $y(3) = 2$



13C Differential equations involving a function of the dependent variable

In this section we solve differential equations of the form

$$\frac{dy}{dx} = g(y)$$

Using the identity $\frac{dx}{dy} = \frac{1}{\frac{dy}{dx}}$, this becomes $\frac{dx}{dy} = \frac{1}{g(y)}$.

If $\frac{dy}{dx} = g(y)$, then $x = \int \frac{1}{g(y)} dy$.

Example 9

Find the general solution of each of the following differential equations:

a $\frac{dy}{dx} = 2y + 1$, for $y > -\frac{1}{2}$

b $\frac{dy}{dx} = e^{2y}$

c $\frac{dy}{dx} = \sqrt{1 - y^2}$, for $y \in (-1, 1)$

d $\frac{dy}{dx} = 1 - y^2$, for $-1 < y < 1$

Solution

a $\frac{dy}{dx} = 2y + 1$ gives $\frac{dx}{dy} = \frac{1}{2y + 1}$.

$$\begin{aligned} \text{Therefore } x &= \int \frac{1}{2y + 1} dy \\ &= \frac{1}{2} \ln |2y + 1| + k && \text{where } k \in \mathbb{R} \\ &= \frac{1}{2} \ln(2y + 1) + k && \text{as } y > -\frac{1}{2} \end{aligned}$$

So $2(x - k) = \ln(2y + 1)$

$$2y + 1 = e^{2(x-k)}$$

i.e. $y = \frac{1}{2}(e^{2(x-k)} - 1)$

This can also be written as $y = \frac{1}{2}(Ae^{2x} - 1)$, where $A = e^{-2k}$.

Note: For $y < -\frac{1}{2}$, the general solution is $y = -\frac{1}{2}(Ae^{2x} + 1)$, where $A = e^{-2k}$.

b $\frac{dy}{dx} = e^{2y}$ gives $\frac{dx}{dy} = e^{-2y}$

Thus $x = \int e^{-2y} dy$

$$x = -\frac{1}{2}e^{-2y} + c$$

$$e^{-2y} = -2(x - c)$$

$$-2y = \ln(-2(x - c))$$

$\therefore y = -\frac{1}{2} \ln(-2(x - c))$

$$= -\frac{1}{2} \ln(2c - 2x), \quad x < c$$

$$\text{c } \frac{dy}{dx} = \sqrt{1-y^2} \text{ gives } \frac{dx}{dy} = \frac{1}{\sqrt{1-y^2}}$$

$$\text{So } x = \int \frac{1}{\sqrt{1-y^2}} dy$$

$$x = \sin^{-1}(y) + c$$

$$\therefore y = \sin(x - c)$$

$$\text{d } \frac{dy}{dx} = 1 - y^2 \text{ gives } \frac{dx}{dy} = \frac{1}{1-y^2}$$

$$\text{Thus } x = \int \frac{1}{1-y^2} dy$$

$$= \int \frac{1}{2(1-y)} + \frac{1}{2(1+y)} dy$$

$$= -\frac{1}{2} \ln(1-y) + \frac{1}{2} \ln(1+y) + c \quad (\text{since } -1 < y < 1)$$

$$\text{So } x - c = \frac{1}{2} \ln\left(\frac{1+y}{1-y}\right)$$

$$e^{2(x-c)} = \frac{1+y}{1-y}$$

Let $A = e^{-2c}$. Then

$$Ae^{2x} = \frac{1+y}{1-y}$$

$$Ae^{2x}(1-y) = 1+y$$

$$Ae^{2x} - 1 = y(1 + Ae^{2x})$$

$$\therefore y = \frac{Ae^{2x} - 1}{Ae^{2x} + 1}$$

Using the TI-Nspire

Use **menu** > **Calculus** > **Differential Equation Solver** and complete as shown.

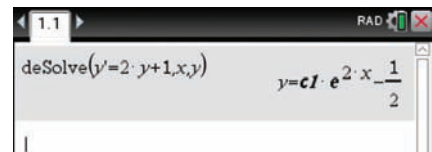

Using the Casio ClassPad

- In $\sqrt{\square}$, enter and highlight the differential equation.
- Go to **Interactive** > **Advanced** > **dSolve**.
- Enter x for *Inde var* and y for *Depe var*.
- Tap **OK**.

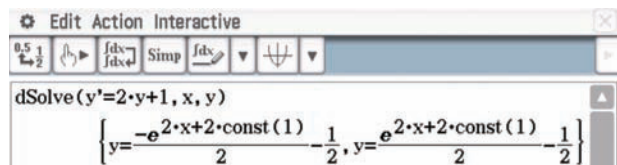

Exercise 13C

Skillsheet
1 Find the general solution of each of the following differential equations:

Example 9

a $\frac{dy}{dx} = 3y - 5, \quad y > \frac{5}{3}$
b $\frac{dy}{dx} = 1 - 2y, \quad y > \frac{1}{2}$
c $\frac{dy}{dx} = e^{2y-1}$
d $\frac{dy}{dx} = \cos^2 y, \quad |y| < \frac{\pi}{2}$
e $\frac{dy}{dx} = \cot y, \quad y \in \left(0, \frac{\pi}{2}\right)$
f $\frac{dy}{dx} = y^2 - 1, \quad |y| < 1$
g $\frac{dy}{dx} = 1 + y^2$
h $\frac{dy}{dx} = \frac{1}{5y^2 + 2y}$
i $\frac{dy}{dx} = \sqrt{y}, \quad y > 0$

2 Find the solution for each of the following differential equations:

a $\frac{dy}{dx} = y$, given that $y = e$ when $x = 0$
b $\frac{dy}{dx} = y + 1$, given that $y(4) = 0$
c $\frac{dy}{dx} = 2y$, given that $y = 1$ when $x = 1$
d $\frac{dy}{dx} = 2y + 1$, given that $y(0) = -1$
e $\frac{dy}{dx} = \frac{e^y}{e^y + 1}$, if $y = 0$ when $x = 0$
f $\frac{dy}{dx} = \sqrt{9 - y^2}$, given that $y(0) = 3$
g $\frac{dy}{dx} = 9 - y^2$, if $y = 0$ when $x = \frac{7}{6}$
h $\frac{dy}{dx} = 1 + 9y^2$, given that $y\left(\frac{-\pi}{12}\right) = -\frac{1}{3}$
i $\frac{dy}{dx} = \frac{y^2 + 2y}{2}$, given that $y = -4$ when $x = 0$

3 For each of the following, find the equation for the family of curves:

a $\frac{dy}{dx} = \frac{1}{y^2}$
b $\frac{dy}{dx} = 2y - 1, \quad y > \frac{1}{2}$

13D Applications of differential equations

Many differential equations arise from scientific or business situations and are constructed from observations and data obtained from experiment.

For example, the following two results from science are described by differential equations:

- **Newton's law of cooling** The rate at which a body cools is proportional to the difference between its temperature and the temperature of its immediate surroundings.
- **Radioactive decay** The rate at which a radioactive substance decays is proportional to the mass of the substance remaining.

These two results will be investigated further in worked examples in this section.

Example 10

The table gives the observed rate of change of a variable x with respect to time t .

t	0	1	2	3	4
$\frac{dx}{dt}$	0	2	8	18	32

- a** Construct the differential equation which applies to this situation.
- b** Solve the differential equation to find x in terms of t , given that $x = 2$ when $t = 0$.

Solution

a From the table, it can be established that $\frac{dx}{dt} = 2t^2$.

b Therefore $x = \int 2t^2 dt = \frac{2t^3}{3} + c$.

When $t = 0$, $x = 2$. This gives $2 = 0 + c$ and so $c = 2$. Hence $x = \frac{2t^3}{3} + 2$.

Differential equations can also be constructed from statements, as shown in the following.

**Example 11**

The population of a city is P at time t years from a certain date. The population increases at a rate that is proportional to the square root of the population at that time. Construct and solve the appropriate differential equation and sketch the population–time graph.

Solution

Remembering that the derivative is a rate, we have $\frac{dP}{dt} \propto \sqrt{P}$. Therefore $\frac{dP}{dt} = k\sqrt{P}$, where k is the constant of variation. Since the population is increasing, we have $k > 0$.

The differential equation is

$$\frac{dP}{dt} = k\sqrt{P}, \quad k > 0$$

Since there are no initial conditions given here, only a general solution for this differential equation can be found. Note that it is of the form $\frac{dy}{dx} = g(y)$.

$$\text{Now } \frac{dt}{dP} = \frac{1}{k\sqrt{P}}$$

$$\begin{aligned} \therefore t &= \frac{1}{k} \int P^{-\frac{1}{2}} dP \\ &= \frac{1}{k} \cdot 2P^{\frac{1}{2}} + c \end{aligned}$$

The general solution is

$$t = \frac{2}{k}\sqrt{P} + c \quad \text{where } c \in \mathbb{R}$$

Rearranging to make P the subject:

$$t = \frac{2}{k}\sqrt{P} + c$$

$$\sqrt{P} = \frac{k}{2}(t - c)$$

$$\therefore P = \frac{k^2}{4}(t - c)^2$$

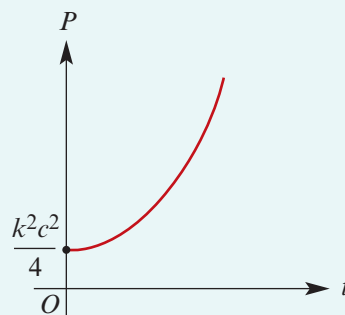

The graph is a section of the parabola $P = \frac{k^2}{4}(t - c)^2$ with vertex at $(c, 0)$.

Example 12

In another city, with population P at time t years after a certain date, the population increases at a rate proportional to the population at that time. Construct and solve the appropriate differential equation and sketch the population–time graph.

Solution

Here $\frac{dP}{dt} \propto P$.

The differential equation is

$$\frac{dP}{dt} = kP, \quad k > 0$$

$$\therefore \frac{dt}{dP} = \frac{1}{kP}$$

$$\therefore t = \frac{1}{k} \int \frac{1}{P} dP$$

$$\therefore t = \frac{1}{k} \ln P + c$$

This is the general solution.

Rearranging to make P the subject:

$$k(t - c) = \ln P$$

$$e^{k(t-c)} = P$$

$$\therefore P = Ae^{kt}, \quad \text{where } A = e^{-kc}$$

The graph is a section of the exponential curve $P = Ae^{kt}$.

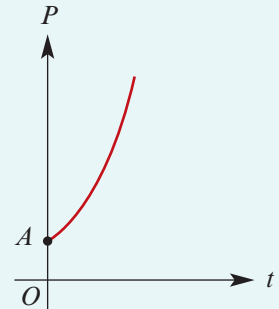
**Example 13**

Suppose that a tank containing liquid has a vent at the top and an outlet at the bottom through which the liquid drains.

Torricelli's law states that if, at time t seconds after opening the outlet, the depth of the liquid is h m and the surface area of the liquid is A m², then

$$\frac{dh}{dt} = \frac{-k\sqrt{h}}{A} \quad \text{where } k > 0$$

(The constant k depends on factors such as the viscosity of the liquid and the cross-sectional area of the outlet.)

Apply Torricelli's law to a cylindrical tank that is initially full, with a height of 1.6 m and a radius length of 0.4 m. Use $k = 0.025$. Construct the appropriate differential equation, solve it and find how many seconds it will take the tank to empty.

Solution

We start by drawing a diagram.

Since the surface area is a circle with constant area $A = \pi \times 0.4^2$, we have

$$\begin{aligned}\frac{dh}{dt} &= \frac{-0.025\sqrt{h}}{\pi \times 0.4^2} \\ &= \frac{-0.025\sqrt{h}}{0.16\pi} \\ &= \frac{-5\sqrt{h}}{32\pi}\end{aligned}$$

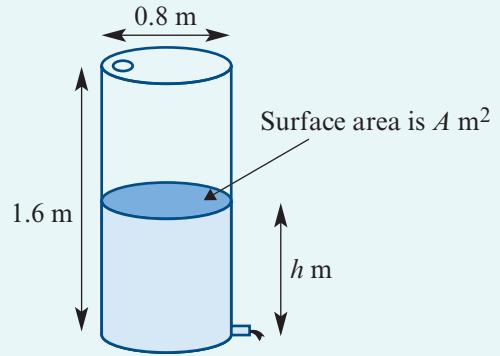

The appropriate differential equation is

$$\begin{aligned}\frac{dh}{dt} &= \frac{-5\sqrt{h}}{32\pi} \\ \therefore \frac{dt}{dh} &= \frac{-32\pi}{5} \cdot h^{-\frac{1}{2}} \\ \therefore t &= \frac{-32\pi}{5} \int h^{-\frac{1}{2}} dh \\ \therefore t &= \frac{-32\pi}{5} \cdot 2h^{\frac{1}{2}} + c \\ \therefore t &= \frac{-64\pi}{5} \sqrt{h} + c\end{aligned}$$

Now use the given condition that the tank is initially full: when $t = 0$, $h = 1.6$.

By substitution:

$$\begin{aligned}0 &= \frac{-64\pi}{5} \sqrt{1.6} + c \\ \therefore c &= \frac{64\pi}{5} \sqrt{1.6}\end{aligned}$$

So the particular solution for this differential equation is

$$\begin{aligned}t &= \frac{-64\pi}{5} \sqrt{h} + \frac{64\pi}{5} \sqrt{1.6} \\ \therefore t &= \frac{-64\pi}{5} (\sqrt{h} - \sqrt{1.6})\end{aligned}$$

Now we find the time when the tank is empty. That is, we find t when $h = 0$.

By substitution:

$$\begin{aligned}t &= \frac{64\pi}{5} (\sqrt{1.6}) \\ \therefore t &\approx 50.9\end{aligned}$$

It will take approximately 51 seconds to empty this tank.

The following example uses Newton's law of cooling.



Example 14

An iron bar is placed in a room which has a temperature of 20°C . The iron bar initially has a temperature of 80°C . It cools to 70°C in 5 minutes. Let T be the temperature of the bar at time t minutes.

- a** Construct a differential equation. **b** Solve this differential equation.
c Sketch the graph of T against t . **d** How long does it take the bar to cool to 40°C ?

Solution

- a** Newton's law of cooling yields

$$\frac{dT}{dt} = -k(T - 20) \quad \text{where } k \in \mathbb{R}^+$$

(Note the use of the negative sign as the temperature is decreasing.)

b
$$\frac{dt}{dT} = \frac{-1}{k(T - 20)}$$

$$\therefore t = -\frac{1}{k} \ln(T - 20) + c, \quad T > 20$$

When $t = 0$, $T = 80$. This gives

$$0 = -\frac{1}{k} \ln(80 - 20) + c$$

$$c = \frac{1}{k} \ln 60$$

$$\therefore t = \frac{1}{k} \ln\left(\frac{60}{T - 20}\right)$$

When $t = 5$, $T = 70$. This gives

$$\frac{1}{k} = \frac{5}{\ln\left(\frac{60}{5}\right)}$$

$$\therefore t = \frac{5}{\ln\left(\frac{60}{5}\right)} \ln\left(\frac{60}{T - 20}\right)$$

This equation can be rearranged to make T the subject:

$$\frac{t}{5} \cdot \ln\left(\frac{60}{5}\right) = \ln\left(\frac{60}{T - 20}\right)$$

$$\ln\left(\left(\frac{60}{5}\right)^{\frac{t}{5}}\right) = \ln\left(\frac{60}{T - 20}\right)$$

$$\left(\frac{60}{5}\right)^{\frac{t}{5}} = \frac{60}{T - 20}$$

$$\text{Hence } T = 20 + 60\left(\frac{5}{6}\right)^{\frac{t}{5}}.$$

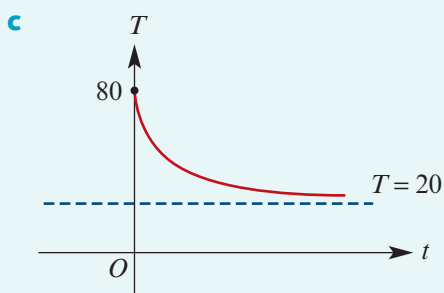

d When $T = 40$, we have

$$t = \frac{5}{\ln\left(\frac{6}{5}\right)} \ln\left(\frac{60}{40-20}\right)$$

$$= 30.1284\dots$$

The bar reaches a temperature of 40°C after 30.1 minutes.

► Difference of rates

Consider the following situations:

- An object is being heated, but at the same time is subject to cooling.
- A population is increasing due to births, but at the same time is diminishing due to deaths.
- A liquid is being poured into a container, while at the same time the liquid is flowing out.

In each of these situations:

$$\text{rate of change} = \text{rate of increase} - \text{rate of decrease}$$

For example, if water is flowing into a container at 8 litres per minute and at the same time water is flowing out of the container at 6 litres per minute, then the overall rate of change is $\frac{dV}{dt} = 8 - 6 = 2$, where the volume of water in the container is V litres at time t minutes.

Example 15

A certain radioactive isotope decays at a rate that is proportional to the mass, m kg, present at any time t years. The rate of decay is $2m$ kg per year. The isotope is formed as a byproduct from a nuclear reactor at a constant rate of 0.5 kg per year. None of the isotope was present initially.

- | | |
|--|---|
| a Construct a differential equation. | b Solve the differential equation. |
| c Sketch the graph of m against t . | d How much isotope is there after two years? |

Solution

a $\frac{dm}{dt} = 0.5 - 2m = \frac{1 - 4m}{2}$

b $\frac{dt}{dm} = \frac{2}{1 - 4m}$

Thus $t = -\frac{2}{4} \ln|1 - 4m| + c$
 $= -\frac{1}{2} \ln(1 - 4m) + c$ (since $0.5 - 2m > 0$)

When $t = 0$, $m = 0$ and therefore $c = 0$.

So $-2t = \ln(1 - 4m)$

$$e^{-2t} = 1 - 4m$$

$$\therefore m = \frac{1}{4}(1 - e^{-2t})$$

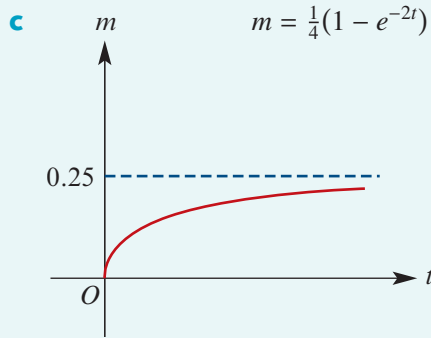

d When $t = 2$,

$$m = \frac{1}{4}(1 - e^{-4})$$

$$= 0.245 \dots$$

After two years, the mass of the isotope is 0.245 kg.



Example 16

Pure oxygen is pumped into a 50-litre tank of air at 5 litres per minute. The oxygen is well mixed with the air in the tank. The mixture is removed at the same rate.

- a** Construct a differential equation, given that plain air contains 23% oxygen.
b After how many minutes does the mixture contain 50% oxygen?

Solution

- a** Let Q litres be the volume of oxygen in the tank at time t minutes.
 When $t = 0$, $Q = 50 \times 0.23 = 11.5$.

$$\frac{dQ}{dt} = \text{rate of inflow} - \text{rate of outflow}$$

$$= 5 - \frac{Q}{50} \times 5$$

i.e. $\frac{dQ}{dt} = \frac{50 - Q}{10}$

b $\frac{dt}{dQ} = \frac{10}{50 - Q}$

$$\therefore t = -10 \ln |50 - Q| + c$$

$$= -10 \ln(50 - Q) + c \quad (\text{as } Q < 50)$$

When $t = 0$, $Q = 11.5$. Therefore

$$c = 10 \ln(38.5)$$

$$\therefore t = 10 \ln\left(\frac{77}{2(50 - Q)}\right)$$

When the mixture is 50% oxygen, we have $Q = 25$ and so

$$t = 10 \ln\left(\frac{77}{2 \times 25}\right)$$

$$= 10 \ln\left(\frac{77}{50}\right)$$

$$= 4.317 \dots$$

The tank contains 50% oxygen after 4 minutes and 19.07 seconds.

Exercise 13D

Example 10

- 1** Each of the following tables gives the results of an experiment where a rate of change was found to be a linear function of time, i.e. $\frac{dx}{dt} = at + b$. For each table, set up a differential equation and solve it using the additional information.

a

t	0	1	2	3	and $x(0) = 3$
$\frac{dx}{dt}$	1	3	5	7	

b

t	0	1	2	3	and $x(1) = 1$
$\frac{dx}{dt}$	-1	2	5	8	

c

t	0	1	2	3	and $x(2) = -3$
$\frac{dx}{dt}$	8	6	4	2	

- 2** For each of the following, construct (but do not attempt to solve) a differential equation:
- a** A family of curves is such that the gradient at any point (x, y) is the reciprocal of the y -coordinate (for $y \neq 0$).
 - b** A family of curves is such that the gradient at any point (x, y) is the square of the reciprocal of the y -coordinate (for $y \neq 0$).
 - c** The rate of increase of a population of size N at time t years is inversely proportional to the square of the population.
 - d** A particle moving in a straight line is x m from a fixed point O after t seconds. The rate at which the particle is moving is inversely proportional to the distance from O .
 - e** The rate of decay of a radioactive substance is proportional to the mass of substance remaining. Let m kg be the mass of the substance at time t minutes.
 - f** The gradient of the normal to a curve at any point (x, y) is three times the gradient of the line joining the same point to the origin.

Example 11, 12

- 3** A city, with population P at time t years after a certain date, has a population which increases at a rate proportional to the population at that time.
- a**
 - i** Set up a differential equation to describe this situation.
 - ii** Solve to obtain a general solution.
 - b** If the initial population was 1000 and after two years the population had risen to 1100:
 - i** find the population after five years
 - ii** sketch a graph of P against t .

Example 13

- 4** An island has a population of rabbits of size P at time t years after 1 January 2010. Due to a virus, the population is decreasing at a rate proportional to the square root of the population at that time.
- Set up a differential equation to describe this situation.
 - Solve to obtain a general solution.
- b** If the population was initially 15 000 and decreased to 13 500 after five years:
- find the population after 10 years
 - sketch a graph of P against t .
- 5** A city has population P at time t years from a certain date. The population increases at a rate inversely proportional to the population at that time.
- Set up a differential equation to describe this situation.
 - Solve to obtain a general solution.
- b** Initially the population was 1 000 000, but after four years it had risen to 1 100 000.
- Find an expression for the population in terms of t .
 - Sketch the graph of P against t .
- 6** A curve has the property that its gradient at any point is one-tenth of the y -coordinate at that point. It passes through the point $(0, 10)$. Find the equation of the curve.

Example 14

- 7** A body at a temperature of 80°C is placed in a room which is kept at a constant temperature of 20°C . After 20 minutes, the temperature of the body is 60°C . Assuming Newton's law of cooling, find the temperature after a further 20 minutes.
- 8** If the thermostat in an electric heater fails, the rate of increase in its temperature, $\frac{d\theta}{dt}$, is 0.01θ K per minute, where the temperature θ is measured in kelvins (K) and the time t in minutes. If the heater is switched on at a room temperature of 300 K and the thermostat does not function, what is the temperature of the heater after 10 minutes?
- 9** The rate of decay of a radioactive substance is proportional to the amount Q of matter present at any time t . The differential equation for this situation is $\frac{dQ}{dt} = -kQ$, where k is a constant. Given that $Q = 50$ when $t = 0$ and that $Q = 25$ when $t = 10$, find the time t at which $Q = 10$.
- 10** The rate of decay of a substance is km , where k is a positive constant and m is the mass of the substance remaining. Show that the half-life (i.e. the time in which the amount of the original substance remaining is halved) is given by $\frac{1}{k} \ln 2$.
- 11** The concentration, x grams per litre, of salt in a solution at time t minutes is given by $\frac{dx}{dt} = \frac{20 - 3x}{30}$.
- If the initial concentration was 2 grams per litre, solve the differential equation, giving x in terms of t .
 - Find the time taken, to the nearest minute, for the salt concentration to rise to 6 grams per litre.

- 12** If $\frac{dy}{dx} = 10 - \frac{y}{10}$ and $y = 10$ when $x = 0$, find y in terms of x . Sketch the graph of the equation for $x \geq 0$.
- 13** The number n of bacteria in a colony grows according to the law $\frac{dn}{dt} = kn$, where k is a positive constant. If the number increases from 4000 to 8000 in four days, find, to the nearest hundred, the number of bacteria after three days more.
- 14** A town had a population of 10 000 in 2000 and 12 000 in 2010. If the population is N at a time t years after 2000, find the predicted population in the year 2020 assuming:
- a** $\frac{dN}{dt} \propto N$ **b** $\frac{dN}{dt} \propto \frac{1}{N}$ **c** $\frac{dN}{dt} \propto \sqrt{N}$
- 15** For each of the following, construct a differential equation, but do not solve it:
- a** Water is flowing into a tank at a rate of 0.3 m^3 per hour. At the same time, water is flowing out through a hole in the bottom of the tank at a rate of $0.2\sqrt{V} \text{ m}^3$ per hour, where $V \text{ m}^3$ is the volume of the water in the tank at time t hours. (Find an expression for $\frac{dV}{dt}$.)
- b** A tank initially contains 200 litres of pure water. A salt solution containing 5 kg of salt per litre is added at the rate of 10 litres per minute, and the mixed solution is drained simultaneously at the rate of 12 litres per minute. There is m kg of salt in the tank after t minutes. (Find an expression for $\frac{dm}{dt}$.)
- c** A partly filled tank contains 200 litres of water in which 1500 grams of salt have been dissolved. Water is poured into the tank at a rate of 6 L/min. The mixture, which is kept uniform by stirring, leaves the tank through a hole at a rate of 5 L/min. There is x grams of salt in the tank after t minutes. (Find an expression for $\frac{dx}{dt}$.)

Example 15

- 16** A certain radioactive isotope decays at a rate that is proportional to the mass, m kg, present at any time t years. The rate of decay is m kg per year. The isotope is formed as a byproduct from a nuclear reactor at a constant rate of 0.25 kg per year. None of the isotope was present initially.
- a** Construct a differential equation.
- b** Solve the differential equation.
- c** Sketch the graph of m against t .
- d** How much isotope is there after two years?

Example 16

- 17** A tank holds 100 litres of water in which 20 kg of sugar was dissolved. Water runs into the tank at the rate of 1 litre per minute. The solution is continually stirred and, at the same time, the solution is being pumped out at 1 litre per minute. At time t minutes, there is m kg of sugar in the solution.
- a** At what rate is the sugar being removed at time t minutes?
- b** Set up a differential equation to represent this situation.
- c** Solve the differential equation.
- d** Sketch the graph of m against t .

- 18** A tank holds 100 litres of pure water. A sugar solution containing 0.25 kg per litre is being run into the tank at the rate of 1 litre per minute. The liquid in the tank is continuously stirred and, at the same time, liquid from the tank is being pumped out at the rate of 1 litre per minute. After t minutes, there is m kg of sugar dissolved in the solution.
- At what rate is the sugar being added to the solution at time t ?
 - At what rate is the sugar being removed from the tank at time t ?
 - Construct a differential equation to represent this situation.
 - Solve this differential equation.
 - Find the time taken for the concentration in the tank to reach 0.1 kg per litre.
 - Sketch the graph of m against t .
- 19** A laboratory tank contains 100 litres of a 20% serum solution (i.e. 20% of the contents is pure serum and 80% is distilled water). A 10% serum solution is then pumped in at the rate of 2 litres per minute, and an amount of the solution currently in the tank is drawn off at the same rate.
- Set up a differential equation to show the relation between x and t , where x litres is the amount of pure serum in the tank at time t minutes.
 - How long will it take for there to be an 18% solution in the tank? (Assume that at all times the contents of the tank form a uniform solution.)
- 20** A tank initially contains 400 litres of water in which is dissolved 10 kg of salt. A salt solution of concentration 0.2 kg/L is poured into the tank at the rate of 2 L/min. The mixture, which is kept uniform by stirring, flows out at the rate of 2 L/min.
- If the mass of salt in the tank is x kg after t minutes, set up and solve the differential equation for x in terms of t .
 - If instead the mixture flows out at 1 L/min, set up (but do not solve) the differential equation for the mass of salt in the tank.
- 21** A tank contains 20 litres of water in which 10 kg of salt is dissolved. Pure water is poured in at a rate of 2 litres per minute, mixing occurs uniformly (owing to stirring) and the water is released at 2 litres per minute. The mass of salt in the tank is x kg at time t minutes.
- Construct a differential equation representing this information, expressing $\frac{dx}{dt}$ as a function of x .
 - Solve the differential equation.
 - Sketch the mass–time graph.
 - How long will it take the original mass of salt to be halved?
- 22** A country's population N at time t years after 1 January 2010 changes according to the differential equation $\frac{dN}{dt} = 0.1N - 5000$. (There is a 10% growth rate and 5000 people leave the country every year.)
- Given that the population was 5 000 000 at the start of 2010, find N in terms of t .
 - In which year will the country have a population of 10 million?



13E The logistic differential equation

In the previous section, we modelled the growth of a population, P , over time, t , using a differential equation of the form

$$\frac{dP}{dt} = kP$$

The solution is $P = P_0 e^{kt}$, where P_0 is the initial population.

This exponential growth model can be appropriate for a short time. However, it is not realistic over a long period of time. This model implies that the population will grow without limit. But the population will be limited by the available resources, such as food and space.

We need a model which acknowledges that there is an upper limit to growth.

Example 17

A population grows according to the differential equation

$$\frac{dP}{dt} = 0.025P \left(1 - \frac{P}{1000}\right), \quad 0 < P < 1000$$

where P is the population at time t . When $t = 0$, $P = 20$.

- a** Find the population P at time t . **b** Sketch the graph of P against t .
c Find the population P when the rate of growth is at a maximum.

Solution

a Write $\frac{dP}{dt} = \frac{P(1000 - P)}{40\,000}$

$$\begin{aligned} \text{Then } t &= \int \frac{40\,000}{P(1000 - P)} dP \\ &= 40 \int \frac{1}{P} + \frac{1}{1000 - P} dP \\ &= 40 (\ln |P| - \ln |1000 - P|) + c \\ &= 40 \ln \left(\frac{P}{1000 - P} \right) + c \quad \text{since } 0 < P < 1000 \end{aligned}$$

$$\therefore e^{\frac{t-c}{40}} = \frac{P}{1000 - P}$$

Let $A = e^{-\frac{c}{40}}$. Then we have

$$Ae^{\frac{t}{40}} = \frac{P}{1000 - P}$$

When $t = 0$, $P = 20$. This implies that $A = \frac{1}{49}$, and so

$$\begin{aligned} (1000 - P)e^{\frac{t}{40}} &= 49P \\ 1000e^{\frac{t}{40}} &= 49P + Pe^{\frac{t}{40}} \end{aligned}$$

$$\text{Hence } P = \frac{1000e^{\frac{t}{40}}}{49 + e^{\frac{t}{40}}}$$

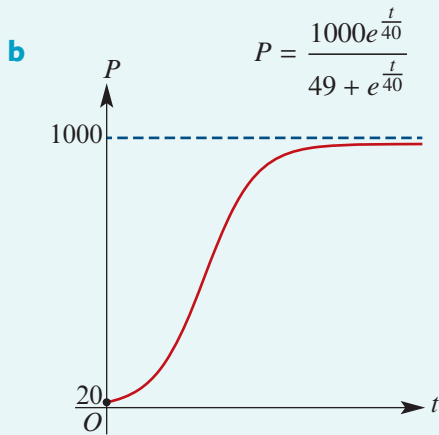

- c** The maximum rate of increase occurs at the point of inflection on the graph.

We have

$$\frac{dP}{dt} = \frac{1000P - P^2}{40\,000}$$

The chain rule gives

$$\frac{d^2P}{dt^2} = \frac{1000 - 2P}{40\,000} \cdot \frac{dP}{dt}$$

Since $0 < P < 1000$, we have $\frac{dP}{dt} \neq 0$.

Therefore $\frac{d^2P}{dt^2} = 0$ implies $P = 500$.

Note: Since $\frac{dP}{dt}$ is a quadratic in P , the maximum rate of increase occurs at the vertex of the parabola, which is midway between its intercepts at $P = 0$ and $P = 1000$.

Logistic differential equation

$$\frac{dP}{dt} = rP\left(1 - \frac{P}{K}\right), \quad 0 < P < K$$

This differential equation can be used to model a population P at time t , where:

- the constant r is called the **growth parameter**
- the constant K is called the **carrying capacity**.

Notes:

- As in the example, we can show that the solution of this differential equation is

$$P(t) = \frac{P_0K}{P_0 + (K - P_0)e^{-rt}} = \frac{P_0Ke^{rt}}{P_0e^{rt} + (K - P_0)} \quad \text{where } P_0 = P(0)$$

- The carrying capacity K is the upper limit on the population: the rate of increase approaches 0 as P approaches K ; the population P approaches K as $t \rightarrow \infty$.
- The maximum rate of increase occurs when $P = \frac{K}{2}$.

Exercise 13E

- 1** Solve the differential equation $\frac{dP}{dt} = P(1 - P)$, where $P(0) = 2$.

Example 17

- 2** A population grows according to the differential equation

$$\frac{dP}{dt} = 0.02P\left(1 - \frac{P}{500}\right), \quad 0 < P < 500$$

where P is the population at time t . When $t = 0$, $P = 100$.

- a** Find the population P at time t . **b** Sketch the graph of P against t .
- c** Find the population P when the rate of growth is at a maximum.

- 3** Let $P(t)$ be the population of a species of fish in a lake after t years. Suppose that $P(t)$ is modelled by a logistic differential equation with a growth parameter of $r = 0.3$ and a carrying capacity of $K = 10\,000$.
- Write down the logistic differential equation for this situation.
 - If $P(0) = 2500$, solve the differential equation for $P(t)$.
 - Sketch the graph of $P(t)$ against t .
 - Find the number of fish in the lake after 5 years.
 - Find the time that it will take for there to be 5000 fish in the lake.

- 4** A population of wasps is growing according to the logistic differential equation, where P is the number of wasps after t months. If the carrying capacity is 500 and the growth parameter is 0.1, what is the maximum possible growth rate for the population?

- 5** A population of bacteria grows according to the differential equation

$$\frac{dP}{dt} = 0.05P(1 - 0.001P), \quad P_0 = 300, \quad 0 < P < 1000$$

Find the population P at time t .

- 6** Suppose that t weeks after the start of an epidemic in a certain community, the number of people who have caught the disease, $P(t)$, is given by the logistic function

$$P(t) = \frac{2000}{5 + 395e^{-\frac{4t}{5}}}$$

- How many people had the disease when the epidemic began?
 - Approximately how many people in total will get the disease?
 - When was the disease spreading most rapidly?
 - How fast was the disease spreading at the peak of the epidemic?
 - At what rate was the disease spreading when 300 people had caught the disease?
- 7** Consider the differential equation $\frac{dP}{dt} = 0.01P\left(1 - \frac{P}{1000}\right)$. For each of the following cases, solve the differential equation and sketch the graph of P against t :
- $P_0 = 1500$ and $P > 1000$
 - $P_0 = 200$ and $0 < P < 1000$
 - $P_0 = 1000$

- 8** A population of rabbits grows in a way described by the logistic differential equation

$$\frac{dP}{dt} = 0.1P\left(1 - \frac{P}{25\,000}\right)$$

where P is the number of rabbits after t months, and the initial population is $P_0 = 2000$.

- Solve the differential equation for P .
- How many rabbits are there after:
 - 6 months
 - 5 years?
- After how many months is the population increasing most rapidly?
- How long does it take for the population to reach 20 000?
- Sketch the graph of P against t .

9 Consider the differential equation

$$\frac{dy}{dx} = -\left(1 - \frac{y}{K_1}\right)\left(1 - \frac{y}{K_2}\right)$$

where K_1 and K_2 are positive constants. Taking $K_1 = 5$ and $K_2 = 10$, solve the differential equation for each of the following cases:



a $y(0) = 20$, $y > 10$ **b** $y(0) = 8$, $5 < y < 10$ **c** $y(0) = 3$, $0 < y < 5$

13F Separation of variables

A first-order differential equation is **separable** if it can be written in the form

$$\frac{dy}{dx} = f(x)g(y)$$

Divide both sides by $g(y)$ (for $g(y) \neq 0$):

$$\frac{1}{g(y)} \frac{dy}{dx} = f(x)$$

Integrate both sides with respect to x :

$$\begin{aligned} \int f(x) dx &= \int \frac{1}{g(y)} \frac{dy}{dx} dx \\ &= \int \frac{1}{g(y)} dy \end{aligned}$$

$$\text{If } \frac{dy}{dx} = f(x)g(y), \text{ then } \int f(x) dx = \int \frac{1}{g(y)} dy.$$

Example 18

Solve the differential equation $\frac{dy}{dx} = e^{2x}(1 + y^2)$.

Solution

First we write the equation in the form

$$\int f(x) dx = \int \frac{1}{g(y)} dy$$

$$\text{i.e. } \int e^{2x} dx = \int \frac{1}{1 + y^2} dy$$

Integrating gives

$$\frac{1}{2}e^{2x} + c_1 = \tan^{-1}(y) + c_2$$

Solve for y :

$$\tan^{-1}(y) = \frac{1}{2}e^{2x} + c \quad (\text{where } c = c_1 - c_2)$$

$$\therefore y = \tan\left(\frac{1}{2}e^{2x} + c\right)$$



Example 19

Find the solution of the differential equation

$$\frac{dy}{dx} = \frac{\sin^2 x}{y^2}$$

that also satisfies $y(0) = 1$.

Solution

First we write the equation in the form

$$\int f(x) dx = \int \frac{1}{g(y)} dy$$

$$\text{i.e. } \int \sin^2 x dx = \int y^2 dy$$

Left-hand side

We use the trigonometric identity $\cos(2x) = 1 - 2\sin^2 x$, which transforms to

$$\sin^2 x = \frac{1}{2}(1 - \cos(2x))$$

$$\begin{aligned} \therefore \int \sin^2 x dx &= \frac{1}{2} \int 1 - \cos(2x) dx \\ &= \frac{1}{2} \left(x - \frac{1}{2} \sin(2x) \right) + c_1 \end{aligned}$$

Right-hand side

$$\int y^2 dy = \frac{y^3}{3} + c_2$$

General solution

We now obtain

$$\begin{aligned} \frac{1}{2} \left(x - \frac{1}{2} \sin(2x) \right) + c_1 &= \frac{y^3}{3} + c_2 \\ \therefore \frac{1}{2} \left(x - \frac{1}{2} \sin(2x) \right) &= \frac{y^3}{3} + c \quad (\text{where } c = c_2 - c_1) \end{aligned}$$

Particular solution

By substituting $y(0) = 1$, we find that $c = -\frac{1}{3}$. Hence

$$\frac{1}{2} \left(x - \frac{1}{2} \sin(2x) \right) = \frac{y^3}{3} - \frac{1}{3}$$

Making y the subject:

$$y^3 = 3 \left(\frac{1}{2} \left(x - \frac{1}{2} \sin(2x) \right) + \frac{1}{3} \right)$$

$$\therefore y = \sqrt[3]{\frac{3}{2} \left(x - \frac{1}{2} \sin(2x) \right) + 1}$$

Example 20

A tank contains 30 litres of a solution of a chemical in water. The concentration of the chemical is reduced by running pure water into the tank at a rate of 1 litre per minute and allowing the solution to run out of the tank at a rate of 2 litres per minute. The tank contains x litres of the chemical at time t minutes after the dilution starts.

- a** Show that $\frac{dx}{dt} = \frac{-2x}{30-t}$.
- b** Find the general solution of this differential equation.
- c** Find the fraction of the original chemical still in the tank after 20 minutes.

Solution

- a** At time t minutes, the volume of solution in the tank is $30 - t$ litres, since solution is flowing out at 2 litres per minute and water is flowing in at 1 litre per minute.

At time t minutes, the fraction of the solution which is the chemical is $\frac{x}{30-t}$.

Hence the rate of flow of the chemical out of the tank is $2 \cdot \frac{x}{30-t}$.

Therefore $\frac{dx}{dt} = \frac{-2x}{30-t}$.

- b** Using separation of variables, we have

$$\int \frac{1}{30-t} dt = \int \frac{-1}{2x} dx$$

$$\therefore -\ln(30-t) + c_1 = -\frac{1}{2} \ln x + c_2$$

$$\therefore \ln x = 2 \ln(30-t) + c \quad (\text{where } c = 2c_2 - 2c_1)$$

Let A_0 be the initial amount of chemical in the solution.

Thus $x = A_0$ when $t = 0$, and therefore

$$c = \ln(A_0) - 2 \ln(30) = \ln\left(\frac{A_0}{900}\right)$$

Hence

$$\ln x = 2 \ln(30-t) + \ln\left(\frac{A_0}{900}\right)$$

$$\ln x = \ln\left(\frac{A_0}{900}(30-t)^2\right)$$

$$\therefore x = \frac{A_0}{900}(30-t)^2$$

- c** When $t = 20$, $x = \frac{1}{9}A_0$. The amount of chemical is one-ninth of the original amount.

Notes:

- We observe that differential equations of the form $\frac{dy}{dx} = g(y)$ can also be solved by separation of variables if $g(y) \neq 0$. The solution will be given by $\int \frac{1}{g(y)} dy = \int 1 dx$.
- When undertaking separation of variables, be careful that you do not lose solutions when dividing. For example, the differential equation $\frac{dy}{dx} = y - 2$ has a constant solution $y = 2$.

Exercise 13F

Skillsheet

1 Find the general solution of each of the following:

Example 18

a $\frac{dy}{dx} = yx$ **b** $\frac{dy}{dx} = \frac{x}{y}$ **c** $\frac{4}{x^2} \frac{dy}{dx} = y$ **d** $\frac{dy}{dx} = \frac{1}{xy}$

Example 19

2 a Solve the differential equation $\frac{dy}{dx} = -\frac{x}{y}$, given that $y(1) = 1$.

b Solve the differential equation $\frac{dy}{dx} = \frac{y}{x}$, given that $y(1) = 1$.

c Sketch the graphs of both solutions on the one set of axes.

3 Solve $(1 + x^2) \frac{dy}{dx} = 4xy$ if $y = 2$ when $x = 1$.

4 Find the equation of the curve which satisfies the differential equation $\frac{dy}{dx} = \frac{x}{y}$ and passes through the point $(2, 3)$.

5 Solve the differential equation $\frac{dy}{dx} = \frac{x+1}{3-y}$ and describe the solution curves.

6 Find the general solution of the differential equation $y^2 \frac{dy}{dx} = \frac{1}{x^3}$.

7 Find the general solution of the differential equation $x^3 \frac{dy}{dx} = y^2(x-3)$, $y \neq 0$.

8 Find the general solution of each of the following:

a $\frac{dy}{dx} = y(1 + e^x)$ **b** $\frac{dy}{dx} = 9x^2y$ **c** $\frac{4}{y^3} \frac{dy}{dx} = \frac{1}{x}$

9 Solve each of the following differential equations:

a $y \frac{dy}{dx} = 1 + x^2$, $y(0) = 1$ **b** $x^2 \frac{dy}{dx} = \cos^2 y$, $y(1) = \frac{\pi}{4}$

10 Find the general solution of the differential equation $\frac{dy}{dx} = \frac{x^2 - x}{y^2 - y}$.

Example 20

11 A tank contains 50 litres of a solution of a chemical in water. The concentration of the chemical is reduced by running pure water into the tank at a rate of 2 litres per minute and allowing the solution to run out of the tank at a rate of 4 litres per minute. The tank contains x litres of the chemical at time t minutes after the dilution starts.

a Show that $\frac{dx}{dt} = \frac{-4x}{50 - 2t}$.

b Find the general solution of this differential equation.

c Find the fraction of the original chemical still in the tank after 10 minutes.

12 Bacteria in a tank of water increase at a rate proportional to the number present. Water is drained out of the tank, initially containing 100 litres, at a steady rate of 2 litres per hour. Let N be the number of bacteria present at time t hours after the draining starts.

a Show that $\frac{dN}{dt} = kN - \frac{2N}{100 - 2t}$.

b If $k = 0.6$ and at $t = 0$, $N = N_0$, find in terms of N_0 the number of bacteria after 24 hours.

13 Solve the differential equation $x \frac{dy}{dx} = y + x^2y$, given that $y = 2\sqrt{e}$ when $x = 1$.



14 Find y in terms of x if $\frac{dy}{dx} = (1 + y)^2 \sin^2 x \cos x$ and $y = 2$ when $x = 0$.

13G Differential equations with related rates

In Chapter 10, the concept of related rates was introduced. This is a useful technique for constructing and solving differential equations in a variety of situations.

Example 21

For the variables x , y and t , it is known that $\frac{dx}{dt} = \tan t$ and $y = 3x$.

a Find $\frac{dy}{dt}$ as a function of t .

b Find the solution of the resulting differential equation.

Solution

a We are given that $y = 3x$ and $\frac{dx}{dt} = \tan t$.

Using the chain rule:

$$\frac{dy}{dt} = \frac{dy}{dx} \frac{dx}{dt}$$

$$\therefore \frac{dy}{dt} = 3 \tan t$$

b $\frac{dy}{dt} = \frac{3 \sin t}{\cos t}$

Let $u = \cos t$. Then $\frac{du}{dt} = -\sin t$.

$$\begin{aligned} \therefore y &= -3 \int \frac{1}{u} du \\ &= -3 \ln |u| + c \end{aligned}$$

$$\therefore y = -3 \ln |\cos t| + c$$



Example 22

An inverted cone has height h cm and radius length r cm. It is being filled with water, which is flowing from a tap at k litres per minute. The depth of water in the cone is x cm at time t minutes.

Construct an appropriate differential equation for $\frac{dx}{dt}$ and solve it, given that initially the cone was empty.

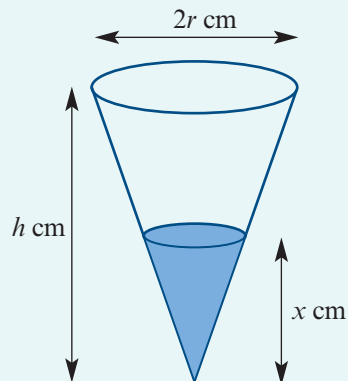

Solution

Let V cm³ be the volume of water at time t minutes.

Since k litres is equal to $1000k$ cm³, the given rate of change is $\frac{dV}{dt} = 1000k$, where $k > 0$.

To find an expression for $\frac{dx}{dt}$, we can use the chain rule:

$$\frac{dx}{dt} = \frac{dx}{dV} \frac{dV}{dt} \quad (1)$$

To find $\frac{dx}{dV}$, we first need to establish the relationship between x and V .

The formula for the volume of a cone gives

$$V = \frac{1}{3}\pi y^2 x \quad (2)$$

where y cm is the radius length of the surface when the depth is x cm.

By similar triangles:

$$\frac{y}{r} = \frac{x}{h}$$

$$\therefore y = \frac{rx}{h}$$

$$\text{So } V = \frac{1}{3}\pi \cdot \frac{r^2 x^2}{h^2} \cdot x \quad (\text{substitution into (2)})$$

$$\therefore V = \frac{\pi r^2}{3h^2} \cdot x^3$$

$$\therefore \frac{dV}{dx} = \frac{\pi r^2}{h^2} \cdot x^2 \quad (\text{by differentiation})$$

$$\therefore \frac{dx}{dV} = \frac{h^2}{\pi r^2} \cdot \frac{1}{x^2}$$

$$\text{So } \frac{dx}{dt} = \frac{h^2}{\pi r^2} \cdot \frac{1}{x^2} \cdot 1000k \quad (\text{substitution into (1)})$$

$$\therefore \frac{dx}{dt} = \frac{1000kh^2}{\pi r^2} \cdot \frac{1}{x^2} \quad \text{where } k > 0$$

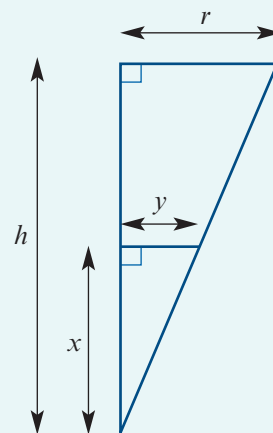

To solve this differential equation:

$$\frac{dt}{dx} = \frac{\pi r^2}{1000kh^2} \cdot x^2$$

$$\begin{aligned} \therefore t &= \frac{\pi r^2}{1000kh^2} \int x^2 dx \\ &= \frac{\pi r^2}{1000kh^2} \cdot \frac{x^3}{3} + c \\ \therefore t &= \frac{\pi r^2 x^3}{3000kh^2} + c \end{aligned}$$

The cone was initially empty, so $x = 0$ when $t = 0$, and therefore $c = 0$.

$$\begin{aligned} \therefore t &= \frac{\pi r^2 x^3}{3000kh^2} \\ \therefore x^3 &= \frac{3000kh^2 t}{\pi r^2} \end{aligned}$$

Hence $x = \sqrt[3]{\frac{3000kh^2 t}{\pi r^2}}$ is the solution of the differential equation.

Using the TI-Nspire

- Use **menu** > **Calculus** > **Differential Equation Solver** and complete as shown.
- Solve for x in terms of t .

Using the Casio ClassPad

- In $\sqrt[n]{a}$, enter and highlight the differential equation $t' = \frac{\pi r^2}{1000kh^2} \times x^2$.
- Select **Interactive** > **Advanced** > **dSolve**.
- Tap *Include condition*.
- Enter x for *Inde var* and t for *Depe var*.
- Enter the condition $t(0) = 0$. (You must select t from the **abc** keyboard.) Tap **OK**.
- Copy the answer to the next entry line and solve for x .

Exercise 13G

Skillsheet

- 1** Construct, but do not solve, a differential equation for each of the following:
- An inverted cone with depth 50 cm and radius 25 cm is initially full of water, which drains out at 0.5 litres per minute. The depth of water in the cone is h cm at time t minutes. (Find an expression for $\frac{dh}{dt}$.)
 - A tank with a flat bottom and vertical sides has a constant horizontal cross-section of A m². The tank has a tap in the bottom through which water is leaving at a rate of $c\sqrt{h}$ m³ per minute, where h m is the height of the water in the tank and c is a constant. Water is being poured into the tank at a rate of Q m³ per minute. (Find an expression for $\frac{dh}{dt}$.)
 - Water is flowing at a constant rate of 0.3 m³ per hour into a tank. At the same time, water is flowing out through a hole in the bottom of the tank at the rate of $0.2\sqrt{V}$ m³ per hour, where V m³ is the volume of the water in the tank at time t hours. It is known that $V = 6\pi h$, where h m is the height of the water at time t . (Find an expression for $\frac{dh}{dt}$.)
 - A cylindrical tank 4 m high with base radius 1.5 m is initially full of water. The water starts flowing out through a hole at the bottom of the tank at the rate of \sqrt{h} m³ per hour, where h m is the depth of water remaining in the tank after t hours. (Find an expression for $\frac{dh}{dt}$.)

Example 21

- 2** For the variables x , y and t , it is known that $\frac{dx}{dt} = \sin t$ and $y = 5x$.
- Find $\frac{dy}{dt}$ as a function of t .
 - Find the solution of the resulting differential equation.

Example 22

- 3** A conical tank has a radius length at the top equal to its height. Water, initially with a depth of 25 cm, leaks out through a hole in the bottom of the tank at the rate of $5\sqrt{h}$ cm³ per minute, where the depth is h cm at time t minutes.

- Construct a differential equation expressing $\frac{dh}{dt}$ as a function of h , and solve it.
- Hence find how long it will take for the tank to empty.

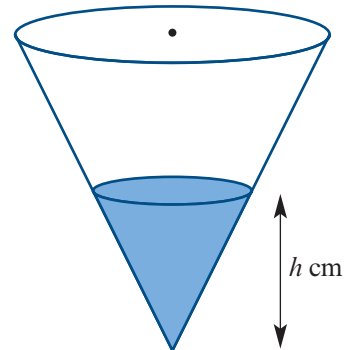

- 4 A cylindrical tank is lying on its side. The tank has a hole in the top, and another in the bottom so that the water in the tank leaks out. The depth of water is x m at time t minutes and

$$\frac{dx}{dt} = \frac{-0.025\sqrt{x}}{A}$$

where A m² is the surface area of the water at time t minutes.

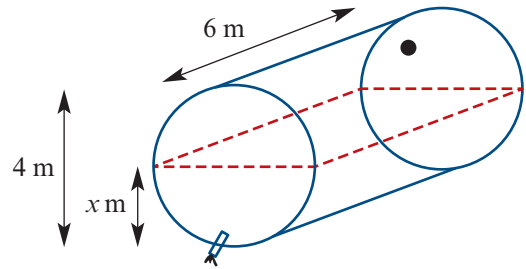

- a Construct the differential equation expressing $\frac{dx}{dt}$ as a function of x only.
- b Solve the differential equation given that initially the tank was full.
- c Find how long it will take to empty the tank.
- 5 A spherical drop of water evaporates so that the volume remaining is V mm³ and the surface area is A mm² when the radius is r mm at time t seconds. Given that $\frac{dV}{dt} = -2A^2$:
- a Construct the differential equation expressing $\frac{dr}{dt}$ as a function of r .
- b Solve the differential equation given that the initial radius was 2 mm.
- c Sketch the graph of A against t and the graph of r against t .
- 6 A water tank of uniform cross-sectional area A cm² is being filled by a pipe which supplies Q litres of water every minute. The tank has a small hole in its base through which water leaks at a rate of kh litres every minute, where h cm is the depth of water in the tank at time t minutes. Initially the depth of the water is h_0 cm.
- a Construct the differential equation expressing $\frac{dh}{dt}$ as a function of h .
- b Solve the differential equation if $Q > kh_0$.
- c Find the time taken for the depth to reach $\frac{Q + kh_0}{2k}$.



13H Using a definite integral to solve a differential equation

There are many situations in which an exact solution to a differential equation $\frac{dy}{dx} = f(x)$ is not required. Indeed, in some cases it may not even be possible to obtain an exact solution. For such differential equations, an approximate solution can be found by numerically evaluating a definite integral.

For the differential equation $\frac{dy}{dx} = f(x)$, consider the problem of finding y when $x = b$, given that $y = d$ when $x = a$.

$$\frac{dy}{dx} = f(x)$$

$$y = F(x) + c \quad \text{by antidifferentiating, where } F'(x) = f(x)$$

$$d = F(a) + c \quad \text{since } y = d \text{ when } x = a$$

$$c = d - F(a)$$

$$\therefore y = F(x) - F(a) + d$$

When $x = b$:

$$y = F(b) - F(a) + d$$

$$\therefore y = \int_a^b f(x) dx + d$$

This idea is very useful for solving a differential equation that cannot be antidifferentiated.

Example 23

For the differential equation $\frac{dy}{dx} = x^2 + 2$, given that $y = 7$ when $x = 1$, find y when $x = 3$.

Solution

Algebraic method

$$\frac{dy}{dx} = x^2 + 2$$

$$\therefore y = \frac{x^3}{3} + 2x + c$$

Since $y = 7$ when $x = 1$, we have

$$7 = \frac{1}{3} + 2 + c$$

$$\therefore c = \frac{14}{3}$$

$$\therefore y = \frac{x^3}{3} + 2x + \frac{14}{3}$$

When $x = 3$:

$$\begin{aligned} y &= \frac{1}{3} \times 3^3 + 2 \times 3 + \frac{14}{3} \\ &= \frac{59}{3} \end{aligned}$$

Using a definite integral

When $x = 3$:

$$y = \int_1^3 (x^2 + 2) dx + 7$$

$$= \left[\frac{x^3}{3} + 2x \right]_1^3 + 7$$

$$= \frac{1}{3} \times 3^3 + 2 \times 3 - \left(\frac{1}{3} + 2 \right) + 7$$

$$= \frac{59}{3}$$

Example 24

Using a definite integral, solve the differential equation $\frac{dy}{dx} = \cos x$ at $x = \frac{\pi}{4}$, given that $y = 0$ at $x = 0$.

Solution

$$\begin{aligned}\frac{dy}{dx} &= \cos x \\ \therefore y &= \int_0^{\frac{\pi}{4}} \cos t \, dt \\ &= [\sin t]_0^{\frac{\pi}{4}} \\ &= \sin\left(\frac{\pi}{4}\right) \\ &= \frac{1}{\sqrt{2}}\end{aligned}$$

Example 25

Solve the differential equation $f'(x) = \frac{1}{\sqrt{2\pi}} e^{-\frac{1}{2}x^2}$ at $x = 1$, given that $f(0) = 0.5$.

Give your answer correct to four decimal places.

Solution

Calculus methods are not available for this differential equation and, since an approximate answer is acceptable, the use of a CAS calculator is appropriate.

The fundamental theorem of calculus gives

$$f(x) = \int_0^x \frac{1}{\sqrt{2\pi}} e^{-\frac{1}{2}t^2} dt + 0.5$$

$$\text{So } f(1) = \int_0^1 \frac{1}{\sqrt{2\pi}} e^{-\frac{1}{2}t^2} dt + 0.5$$

The required answer is 0.8413, correct to four decimal places.

Exercise 13H**Example 24, 25**

1 For each of the following, use a calculator to find values correct to four decimal places:

a $\frac{dy}{dx} = \sqrt{\cos x}$ and $y = 1$ when $x = 0$. Find y when $x = \frac{\pi}{4}$.

b $\frac{dy}{dx} = \frac{1}{\sqrt{\cos x}}$ and $y = 1$ when $x = 0$. Find y when $x = \frac{\pi}{4}$.

c $\frac{dy}{dx} = \ln(x^2)$ and $y = 2$ when $x = 1$. Find y when $x = e$.

d $\frac{dy}{dx} = \sqrt{\ln x}$ and $y = 2$ when $x = 1$. Find y when $x = e$.



131 Using Euler's method to solve a differential equation



In this section we discuss a method of finding an approximate solution to a differential equation. This is done by finding a sequence of points $(x_0, y_0), (x_1, y_1), (x_2, y_2), \dots, (x_n, y_n)$ which lie on a curve which approximates the solution curve of the given differential equation.

Linear approximation to a curve

From the diagram, we have

$$\frac{f(x+h) - f(x)}{h} \approx f'(x) \quad \text{for small } h$$

Rearranging this equation gives

$$f(x+h) \approx f(x) + hf'(x)$$

This is shown on the diagram. The line ℓ is a tangent to $y = f(x)$ at the point with coordinates $(x, f(x))$.

This gives an approximation to the curve $y = f(x)$ in that the y -coordinate of B is an approximation to the y -coordinate of A on the graph of $y = f(x)$.

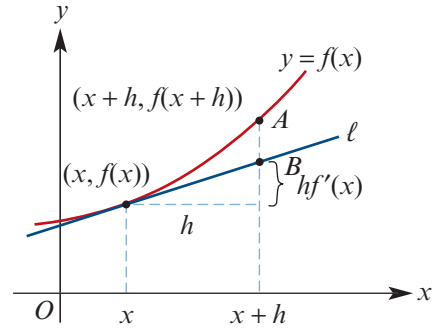

The start of the process

For example, consider the differential equation

$$f'(x) = x^2 - 2x \quad \text{with } f(3) = 0$$

We start with the point $(x_0, y_0) = (3, 0)$.

The graph shown is a section of the solution curve for the differential equation. In this case, we are taking $h = 0.1$, and so $f(x+h) \approx f(x) + hf'(x)$ gives

$$f(3.1) \approx 0 + 0.1 \times 3 = 0.3$$

So the next point in the sequence is $(x_1, y_1) = (3.1, 0.3)$.

Note that the actual value of $f(3.1)$ is $\frac{961}{3000} \approx 0.32$.

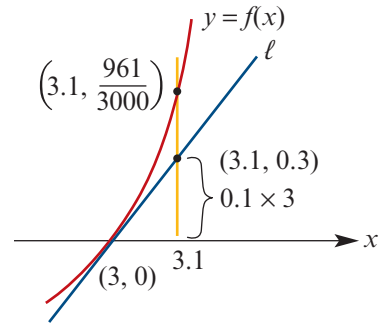

The general process

This process can be repeated to generate a longer sequence of points.

We start again at the beginning. Consider the differential equation

$$\frac{dy}{dx} = g(x) \quad \text{with } y(x_0) = y_0$$

Then $x_1 = x_0 + h$ and $y_1 = y_0 + hg(x_0)$.

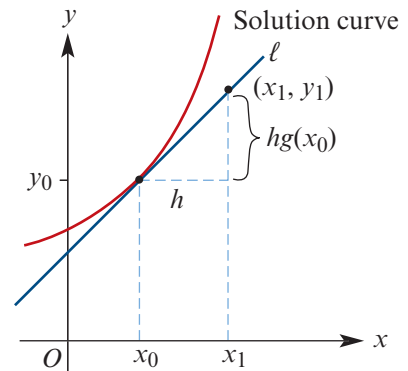

The process is now applied repeatedly to approximate the value of the function at x_2, x_3, \dots

The result is:

$$x_2 = x_1 + h \quad \text{and} \quad y_2 = y_1 + hg(x_1)$$

$$x_3 = x_2 + h \quad \text{and} \quad y_3 = y_2 + hg(x_2)$$

and so on.

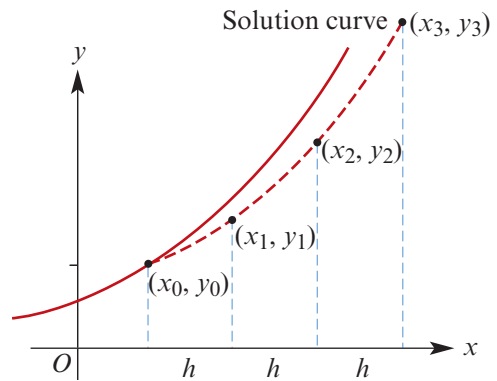

The point (x_n, y_n) is found in the n th step of the iterative process.

This iterative process can be summarised as follows.

Euler's formula

If $\frac{dy}{dx} = g(x)$ with $x_0 = a$ and $y_0 = b$, then

$$x_{n+1} = x_n + h \quad \text{and} \quad y_{n+1} = y_n + hg(x_n)$$

The accuracy of this formula, and the associated process, can be checked against the values obtained through the solution of the differential equation, where the result is known.

Euler's method for $f'(x) = x^2 - 2x$

The table gives the sequence of points (x_i, y_i) , $0 \leq i \leq 10$, when Euler's method is applied to the differential equation

$$f'(x) = x^2 - 2x \quad \text{with} \quad f(3) = 0$$

using a step size of $h = 0.1$.

The solution to this differential equation is

$$f(x) = \frac{x^3}{3} - x^2$$

The values $f(x_i)$ of the solution are given in the last column of the table.

As can be seen, the y -values obtained using Euler's method are reasonably close to the actual values of the solution.

i	x_i	y_i	$g(x_i)$	$f(x_i)$
0	3	0	3	0
1	3.1	0.3	3.41	0.320
2	3.2	0.641	3.84	0.683
3	3.3	1.025	4.29	1.089
4	3.4	1.454	4.76	1.541
5	3.5	1.93	5.25	2.042
6	3.6	2.455	5.76	2.592
7	3.7	3.031	6.29	3.194
8	3.8	3.66	6.84	3.851
9	3.9	4.344	7.41	4.563
10	4.0	5.085		5.333

A smaller step size h would yield a better approximation. For example, using $h = 0.01$, the approximation to $f(4)$ is 5.3085. The percentage error for $x = 4$ using $h = 0.1$ is 4.65%, but using $h = 0.01$ the error is 0.46%.

Example 26

- a** Let $\frac{dy}{dx} = 2x$ and $y(0) = 3$. Find y_4 using Euler's formula with steps of 0.1.
- b** Let $\frac{dy}{dx} = -3x^2$ and $y(1) = 4$. Find y_3 using Euler's formula with steps of 0.2.

Solution

- a Step 0** $x_0 = 0$ and $y_0 = 3$
- Step 1** $x_1 = 0 + 0.1 = 0.1$ and $y_1 = 3 + 0.1 \times 0 = 3$
- Step 2** $x_2 = 0.1 + 0.1 = 0.2$ and $y_2 = 3 + 0.1 \times 2 \times 0.1 = 3.02$
- Step 3** $x_3 = 0.2 + 0.1 = 0.3$ and $y_3 = 3.02 + 0.1 \times 2 \times 0.2 = 3.06$
- Step 4** $x_4 = 0.3 + 0.1 = 0.4$ and $y_4 = 3.06 + 0.1 \times 2 \times 0.3 = 3.12$
- b Step 0** $x_0 = 1$ and $y_0 = 4$
- Step 1** $x_1 = 1 + 0.2 = 1.2$ and $y_1 = 4 + 0.2 \times (-3) = 3.4$
- Step 2** $x_2 = 1.2 + 0.2 = 1.4$ and $y_2 = 3.4 + 0.2 \times (-3) \times (1.2)^2 = 2.536$
- Step 3** $x_3 = 1.4 + 0.2 = 1.6$ and $y_3 = 2.536 + 0.2 \times (-3) \times (1.4)^2 = 1.36$

► Using a calculator for Euler's method**Example 27**

Use a CAS calculator to approximate the solution of the differential equation $\frac{dy}{dx} = e^{\sin x}$ with $y(0) = 1$:

- a** using step size 0.1
- b** using step size 0.01.

Using the TI-Nspire

- Choose a **Lists & Spreadsheet** application.
 - Enter 0 in A1, 0 in B1, 1 in C1, and $= e^{\sin(b1)}$ in D1.
 - Fill down in Column D. To do this, select cell D1 and then (menu) > **Data** > **Fill**. Use the arrow keys to go down to cell D10 and press (enter).
- a** Now in A2, enter $= a1 + 1$.
In B2, enter $= b1 + 0.1$.
In C2, enter $= c1 + 0.1 \times d1$.
Select A2, B2 and C2 and fill down to row 10.

	A	B	C	D
1	0	0	1	1
2	1	0.1	1.1	1.10498...
3	2	0.2	1.21049...	1.21977...
4	3	0.3	1.33247...	1.34382...
5	4	0.4	1.46685...	1.47612...

D1 = $e^{\sin(b1)}$

- b** In B2, enter $= b1 + 0.01$.
 In C2, enter $= c1 + 0.01 \times d1$.
 Select B2 and C2 and fill down to row 10.

	A	B	C	D
1		0	0	1
2		1	0.01	1.01
3		2	0.02	1.02010...
4		3	0.03	1.03030...
5		4	0.04	1.04060...

Formula bar: $=c1+0.01 \cdot d1$

Using the Casio ClassPad

In , select **Sequence** . Tap the **Recursive** window and choose the setting $\begin{matrix} n+1 \\ a_0 \end{matrix}$.

- a** To generate the x -values with step size 0.1:
- Tap on a_{n+1} and enter $a_n + 0.1$. (Note that a_n can be selected from the menu bar.)
 - Tap on a_0 and enter the initial value 0.

To generate the y -values:

- Tap on b_{n+1} and enter $b_n + 0.1e^{\sin(a_n)}$.
- Tap on b_0 and enter the initial value 1.

To view the table of values:

- First tap  to set the table to 15 rows.

Sequence Table Input

Start : 1

End : 15

OK Cancel

- Tick all boxes and tap the table icon .
- Resize to view all 15 rows.

Edit Graph

Recursive Explicit

$a_{n+1} = a_n + 0.1$
 $a_0 = 0$

$b_{n+1} = b_n + 0.1 \cdot e^{\sin(a_n)}$
 $b_0 = 1$

$c_{n+1} = \square$
 $c_0 = 0$

Edit Graph

n	a_n	b_n
1	0.1	1.1
2	0.2	1.2105
3	0.3	1.3325
4	0.4	1.4669
5	0.5	1.6145
6	0.6	1.7760
7	0.7	1.9519
8	0.8	2.1423
9	0.9	2.3472
10	1	2.5661
11	1.1	2.7981
12	1.2	3.0419
13	1.3	3.2958
14	1.4	3.5579
15	1.5	3.8258

- b** To generate the x -values with step size 0.01:
- Tap on a_{n+1} and enter $a_n + 0.01$.
 - Tap on a_0 and enter the initial value 0.
- To generate the y -values:
- Tap on b_{n+1} and enter $b_n + 0.01e^{\sin(a_n)}$.
 - Tap on b_0 and enter the initial value 1.

Edit Graph

Recursive Explicit

$a_{n+1} = a_n + 0.01$
 $a_0 = 0$

$b_{n+1} = b_n + 0.01 \cdot e^{\sin(a_n)}$
 $b_0 = 1$

$c_{n+1} = \square$
 $c_0 = 0$

To view the table of values:

- Tick all boxes and tap the table icon .
- Resize to view all 15 rows.

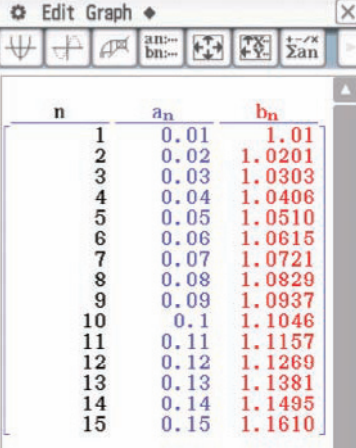

n	a_n	b_n
1	0.01	1.01
2	0.02	1.0201
3	0.03	1.0303
4	0.04	1.0406
5	0.05	1.0510
6	0.06	1.0615
7	0.07	1.0721
8	0.08	1.0829
9	0.09	1.0937
10	0.1	1.1046
11	0.11	1.1157
12	0.12	1.1269
13	0.13	1.1381
14	0.14	1.1495
15	0.15	1.1610

► General version of Euler's method

More generally, we can use Euler's method to find an approximate solution to a differential equation of the form

$$\frac{dy}{dx} = g(x, y)$$

with $x_0 = a$ and $y_0 = b$. The iterative rule is

$$x_{n+1} = x_n + h \quad \text{and} \quad y_{n+1} = y_n + hg(x_n, y_n)$$

For example, for $\frac{dy}{dx} = y^2 + 1$ with $x_0 = 0$ and $y_0 = 0$, the rule is

$$x_{n+1} = x_n + h \quad \text{and} \quad y_{n+1} = y_n + h(y_n^2 + 1)$$

Exercise 131

Example 26

1 For each of the following, apply Euler's method to find the indicated y_n -value using the given step size h . Give each answer correct to four decimal places.

a $\frac{dy}{dx} = \cos x$, given $y_0 = y(0) = 1$, find y_3 using $h = 0.1$

b $\frac{dy}{dx} = \frac{1}{x^2}$, given $y_0 = y(1) = 0$, find y_4 using $h = 0.01$

c $\frac{dy}{dx} = \sqrt{x}$, given $y_0 = y(1) = 1$, find y_3 using $h = 0.1$

d $\frac{dy}{dx} = \frac{1}{x^2 + 3x + 2}$, given $y_0 = y(0) = 0$, find y_3 using $h = 0.01$

Example 27

2 Solve each of the following differential equations using:

- i** a calculus method **ii** a spreadsheet with a step size of 0.01.

a $\frac{dy}{dx} = \cos x$, given $y(0) = 1$, find $y(1)$

b $\frac{dy}{dx} = \frac{1}{x^2}$, given $y(1) = 0$, find $y(2)$

c $\frac{dy}{dx} = \sqrt{x}$, given $y(1) = 1$, find $y(2)$

d $\frac{dy}{dx} = \frac{1}{x^2 + 3x + 2}$, given $y(0) = 0$, find $y(2)$

3 Solve the differential equation $\frac{dy}{dx} = \sec^2 x$ at $x = 1$, given that $y = 2$ when $x = 0$, using:

a a calculus method

b a spreadsheet with step size:

- i** 0.1 **ii** 0.05 **iii** 0.01

4 Use Euler's method with steps of size 0.1 to find an approximate value of y at $x = 0.5$ if $\frac{dy}{dx} = y^3$ and $y = 1$ when $x = 0$.

5 Use Euler's method with steps of size 0.1 to find an approximate value of y at $x = 1$ if $\frac{dy}{dx} = y^2 + 1$ and $y = 1$ when $x = 0$.

6 Use Euler's method with steps of size 0.1 to find an approximate value of y at $x = 1$ if $\frac{dy}{dx} = xy$ and $y = 1$ when $x = 0$.

7 The graph for the standard normal distribution is given by the rule

$$f(x) = \frac{1}{\sqrt{2\pi}} e^{-\frac{1}{2}x^2}$$

Probabilities can be found using

$$\Pr(Z \leq z) = \int_{-\infty}^z f(x) dx = \frac{1}{2} + \int_0^z f(x) dx$$

Let $y = \Pr(Z \leq z)$. Then $\frac{dy}{dz} = f(z)$ with $y(0) = \frac{1}{2}$.

- a** Use Euler's method with a step size of 0.1 to find an approximation for $\Pr(Z \leq z)$, where $z = 0, 0.1, 0.2, \dots, 0.9, 1$.
- b** Compare the values found in **a** with the probabilities found using a CAS calculator.
- c** Use a step size of 0.01 to obtain an approximation for:
- i** $\Pr(Z \leq 0.5)$ **ii** $\Pr(Z \leq 1)$



13J Slope field for a differential equation



Consider a differential equation of the form $\frac{dy}{dx} = f(x)$.

The **slope field** of this differential equation assigns to each point $P(x, y)$ in the plane (for which x is in the domain of f) the number $f(x)$, which is the gradient of the solution curve through P .

For the differential equation $\frac{dy}{dx} = 2x$, a gradient value is assigned for each point $P(x, y)$.

- For $(1, 3)$ and $(1, 5)$, the gradient value is 2.
- For $(-2, 5)$ and $(-2, -2)$, the gradient value is -4 .

A slope field can, of course, be represented in a graph.

The slope field for $\frac{dy}{dx} = 2x$ is shown opposite.

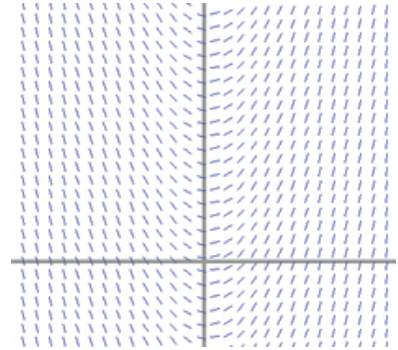

When initial conditions are given, a particular solution curve can be drawn.

Here the solution curve with $y = 2$ when $x = 0$ has been superimposed on the slope field for $\frac{dy}{dx} = 2x$.

Changing the initial conditions changes the particular solution.

A slope field is defined similarly for any differential equation of the form $\frac{dy}{dx} = f(x, y)$.

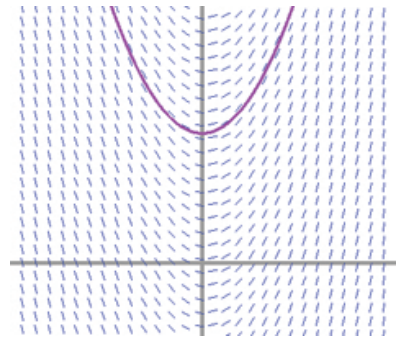

Example 28

- a Use a CAS calculator to plot the slope field for the differential equation $\frac{dy}{dt} = y$.
- b On the plot of the slope field, plot the graphs of the particular solutions for:
 - i $y = 2$ when $t = 0$
 - ii $y = -3$ when $t = 1$.

Using the TI-Nspire

- a ■ In a **Graphs** application, select **(menu) > Graph Entry/Edit > Diff Eq.**
- Enter the differential equation as $y1' = y1$.
- Press **(enter)** to plot the slope field.

Note: The notation must match when entering the differential equation. (Here $y1$ is used for y .)

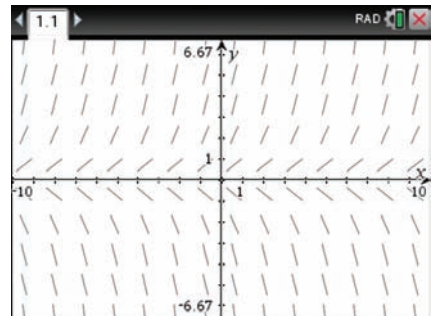

- b** In the graph entry line, you have the option of adding several initial conditions.
- To show the graph entry line, press **(tab)** or double click in an open area.
 - Arrow up to y_1' and add the first set of initial conditions: $x = 0$ and $y_1 = 2$.
 - Click on the green 'plus' icon to add more initial conditions: $x = 1$ and $y_1 = -3$.
 - Select **OK** to plot the solution curves for the given initial conditions.

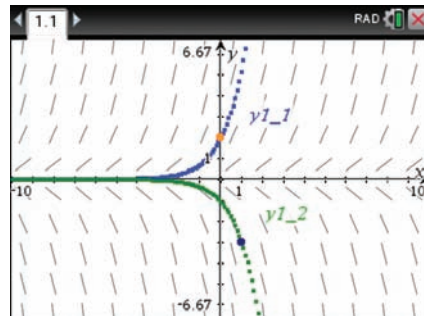
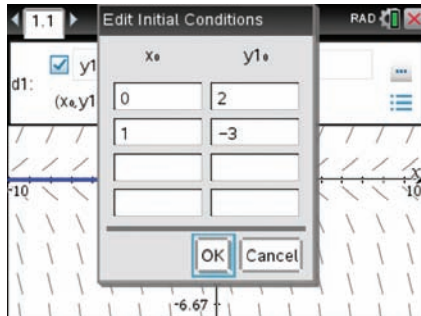

Note: You can grab the initial point and drag to show differing initial conditions.

Using the Casio ClassPad

- a**
- Open the menu .
 - Select **DiffEqGraph** .
 - Tap on y' and type y .
 - Tap the slope field icon .
- b**
- Tap the **IC** window.
 - Enter the initial conditions as shown.
 - Tap the slope field icon .
 - Tap  to adjust the window.

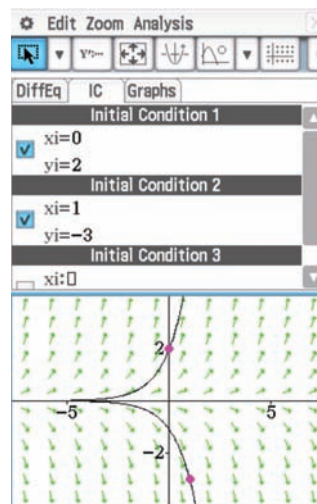
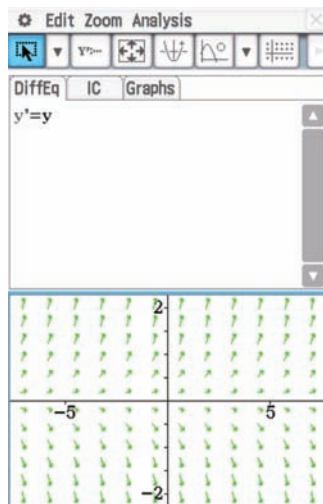

The differential equation $\frac{dy}{dt} = y$ can be solved analytically in the usual manner.

Write $\frac{dt}{dy} = \frac{1}{y}$. Then $t = \ln|y| + c$, which implies $|y| = e^{t-c} = Ae^t$.

- If $y = 2$ when $t = 0$, then $A = 2$ and therefore $y = 2e^t$, as $y > 0$.
- If $y = -3$ when $t = 1$, then $A = 3e^{-1}$ and therefore $y = -3e^{t-1}$, as $y < 0$.

Example 29

Use a CAS calculator to plot the slope field for the differential equation $\frac{dy}{dx} = -\frac{x}{2y}$ and show the solution for the initial condition $x = 0, y = 1$.

Using the TI-Nspire

- In a **Graphs** application, select $\left[\text{menu} \right] > \mathbf{Graph}$
Entry/Edit > **Diff Eq.**
- Enter the differential equation as $y1' = -\frac{x}{2y1}$.
- Enter the initial conditions $x = 0$ and $y1 = 1$.
- Press $\left[\text{enter} \right]$.

Note: Set the window to $-3 \leq x \leq 3$ and $-2 \leq y \leq 2$.

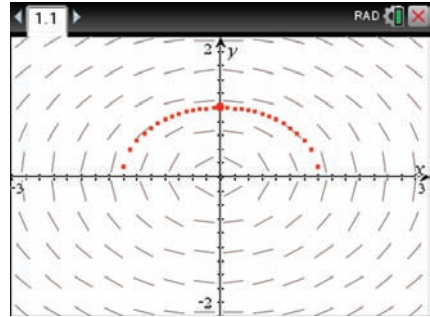
**Exercise 13J**

- 1** For each of the following differential equations, sketch a slope field graph and the solution curve for the given initial conditions, using $-3 \leq x \leq 3$ and $-3 \leq y \leq 3$. Use calculus to solve the differential equation in each case.

- a** $\frac{dy}{dx} = 3x^2$, given $y = 0$ when $x = 1$
- b** $\frac{dy}{dx} = \sin x$, given $y = 0$ when $x = 0$ (use radian mode)
- c** $\frac{dy}{dx} = e^{-2x}$, given $y = 1$ when $x = 0$
- d** $\frac{dy}{dx} = y^2$, given $y = 1$ when $x = 1$
- e** $\frac{dy}{dx} = y^2$, given $y = -1$ when $x = 1$
- f** $\frac{dy}{dx} = y(y - 1)$, given $y = -1$ when $x = 0$
- g** $\frac{dy}{dx} = y(y - 1)$, given $y = 2$ when $x = 0$
- h** $\frac{dy}{dx} = \tan x$, given $y = 0$ when $x = 0$

- 2** For each of the following differential equations, sketch a slope field graph and the solution curve for the given initial conditions, using $-3 \leq x \leq 3$ and $-3 \leq y \leq 3$. Do not attempt to solve the differential equations by calculus methods.

- a** $\frac{dy}{dx} = -\frac{x}{y}$, where at $x = 0, y = \pm 1$
- b** $\frac{dy}{dx} = -\frac{x}{y}$ where at $x = \frac{1}{2}, y = \frac{\sqrt{3}}{2}$



Chapter summary



- A differential equation is an equation that contains at least one derivative.
- A solution of a differential equation is a function that satisfies the differential equation when it and its derivatives are substituted. The general solution is the family of functions that satisfy the differential equation.

Differential equation	Method of solution
$\frac{dy}{dx} = f(x)$	$\frac{dy}{dx} = f(x)$ $\therefore y = \int f(x) dx$ $= F(x) + c, \quad \text{where } F'(x) = f(x)$
$\frac{d^2y}{dx^2} = f(x)$	$\frac{d^2y}{dx^2} = f(x)$ $\frac{dy}{dx} = \int f(x) dx$ $= F(x) + c, \quad \text{where } F'(x) = f(x)$ $\therefore y = \int F(x) + c dx$ $= G(x) + cx + d, \quad \text{where } G'(x) = F(x)$
$\frac{dy}{dx} = g(y)$	$\frac{dy}{dx} = g(y)$ $\frac{dx}{dy} = \frac{1}{g(y)}$ $\therefore x = \int \frac{1}{g(y)} dy$ $= F(y) + c, \quad \text{where } F'(y) = \frac{1}{g(y)}$
$\frac{dy}{dx} = f(x)g(y)$	$\frac{dy}{dx} = f(x)g(y)$ $f(x) = \frac{1}{g(y)} \frac{dy}{dx}$ $\int f(x) dx = \int \frac{1}{g(y)} dy$

- Slope field

The slope field of a differential equation

$$\frac{dy}{dx} = f(x, y)$$

assigns to each point $P(x, y)$ in the plane (for which $f(x, y)$ is defined) the number $f(x, y)$, which is the gradient of the solution curve through P .

■ Euler's method

For $\frac{dy}{dx} = g(x)$ with $y = y_0$ when $x = x_0$:

$$x_1 = x_0 + h \quad \text{and} \quad y_1 = y_0 + hg(x_0)$$

$$x_2 = x_1 + h \quad \text{and} \quad y_2 = y_1 + hg(x_1)$$

$$x_3 = x_2 + h \quad \text{and} \quad y_3 = y_2 + hg(x_2)$$

$$\vdots \qquad \qquad \qquad \vdots$$

$$x_{n+1} = x_n + h \quad \text{and} \quad y_{n+1} = y_n + hg(x_n)$$

The sequence of points $(x_0, y_0), (x_1, y_1), (x_2, y_2), \dots, (x_n, y_n)$ approximate a solution curve for the differential equation.

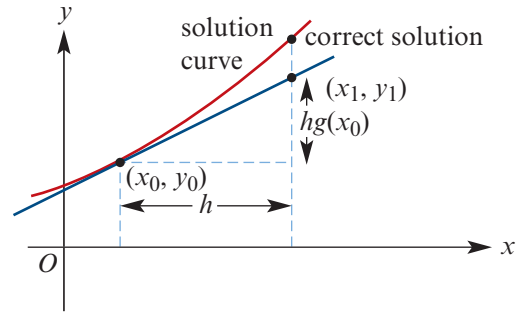

Short-answer questions

1 Find the general solution of each of the following differential equations:

a $\frac{dy}{dx} = \frac{x^2 + 1}{x^2}, \quad x > 0$

b $\frac{1}{y} \cdot \frac{dy}{dx} = 10, \quad y > 0$

c $\frac{d^2y}{dt^2} = \frac{1}{2}(\sin(3t) + \cos(2t)), \quad t \geq 0$

d $\frac{d^2y}{dx^2} = \frac{e^{-x} + e^x}{e^{2x}}$

e $\frac{dy}{dx} = \frac{3 - y}{2}, \quad y < 3$

f $\frac{dy}{dx} = \frac{3 - x}{2}$

2 Find the solution of the following differential equations under the stated conditions:

a $\frac{dy}{dx} = \pi \cos(2\pi x)$, if $y = -1$ when $x = \frac{5}{2}$

b $\frac{dy}{dx} = \cot(2x)$, if $y = 0$ when $x = \frac{\pi}{4}$

c $\frac{dy}{dx} = \frac{1 + x^2}{x}$, if $y = 0$ when $x = 1$

d $\frac{dy}{dx} = \frac{x}{1 + x^2}$, if $y(0) = 1$

e $6 \frac{dy}{dx} = -3y$, if $y = e^{-1}$ when $x = 2$

f $\frac{d^2x}{dt^2} = -10$, given that $\frac{dx}{dt} = 4$ when $x = 0$ and that $x = 0$ when $t = 4$

3 **a** If $y = x \sin x$ is a solution of the differential equation $x^2 \frac{d^2y}{dx^2} - kx \frac{dy}{dx} + (x^2 - m)y = 0$, find k and m .

b Show that $y = xe^{2x}$ is a solution of the differential equation $\frac{d^2y}{dx^2} - \frac{dy}{dx} - 3e^{2x} = 2xe^{2x}$.

4 The curve with equation $y = f(x)$ passes through the point $P\left(\frac{\pi}{4}, 3\right)$, with a gradient of 1 at this point, and $f''(x) = 2 \sec^2(x)$.

a Find the gradient of the curve at $x = \frac{\pi}{6}$. **b** Find $f''\left(\frac{\pi}{6}\right)$.

- 5** Find all real values of n such that $y = e^{nx}$ is a solution of $\frac{d^2y}{dx^2} - 2\frac{dy}{dx} - 15y = 0$.
- 6** Let $\frac{dy}{dx} = (y + 4)^2 + 9$ and $y_0 = y(0) = 0$.
- Solve this differential equation, giving y as a function of x .
 - Using Euler's method with a step size of 0.2, find y_1 .
- 7** **a** Use Euler's method to find y_2 if $\frac{dy}{dx} = \frac{1}{x^2}$, given that $y_0 = y(1) = \frac{1}{2}$ and $h = 0.1$.
- Solve the differential equation.
 - Find the value of y approximated by y_2 .
- 8** Consider the differential equation $\frac{dy}{dx} = 4 + y^2$.
- Sketch the slope field of the differential equation for $y = -2, -1, 0, 1, 2$ at $x = -2, -1, 0, 1, 2$.
 - If $y = -1$ when $x = 2$, solve the differential equation, giving your answer with y in terms of x .
- 9** A container of water is heated to boiling point (100°C) and then placed in a room with a constant temperature of 25°C . After 10 minutes, the temperature of the water is 85°C . Newton's law of cooling gives $\frac{dT}{dt} = -k(T - 25)$, where $T^\circ\text{C}$ is the temperature of the water at time t minutes after being placed in the room.
- Find the value of k .
 - Find the temperature of the water 15 minutes after it was placed in the room.
- 10** Solve the differential equation $\frac{dy}{dx} = 2x\sqrt{25 - x^2}$, for $-5 \leq x \leq 5$, given that $y = 25$ when $x = 4$.
- 11** If $y = e^x \sin(x)$ is a solution to the differential equation $\frac{d^2y}{dx^2} + k\frac{dy}{dx} + y = e^x \cos(x)$, find the value of k .
- 12** If a hemispherical bowl of radius 6 cm contains water to a depth of x cm, the volume, V cm³, is given by
- $$V = \frac{\pi}{3}x^2(18 - x)$$
- If water is poured into the bowl at the rate of 3 cm³/s, construct the differential equation expressing $\frac{dx}{dt}$ as a function of x .
- 13** A circle has area A cm² and circumference C cm at time t seconds. If the area is increasing at a rate of 4 cm²/s, construct the differential equation expressing $\frac{dC}{dt}$ as a function of C .
- 14** A population of size x is decreasing according to the law $\frac{dx}{dt} = -\frac{x}{100}$, where t denotes the time in days. If initially the population is of size x_0 , find to the nearest day how long it takes for the size of the population to be halved.

- 15** Some students put 3 kilograms of soap powder into a water fountain. The soap powder totally dissolved in the 1000 litres of water, thus forming a solution in the fountain. When the soap solution was discovered, clean water was run into the fountain at the rate of 40 litres per minute. The clean water and the solution in the fountain mixed instantaneously and the excess mixture was removed immediately at a rate of 40 litres per minute. If S kilograms was the amount of soap powder in the fountain t minutes after the soap solution was discovered, construct and solve the differential equation to fit this situation.
- 16** A metal rod that is initially at a temperature of 10°C is placed in a warm room. After t minutes, the temperature, $\theta^\circ\text{C}$, of the rod is such that $\frac{d\theta}{dt} = \frac{30 - \theta}{20}$.
- Solve this differential equation, expressing θ in terms of t .
 - Calculate the temperature of the rod after one hour has elapsed, giving the answer correct to the nearest degree.
 - Find the time taken for the temperature of the rod to rise to 20°C , giving the answer correct to the nearest minute.
- 17** A fire broke out in a forest and, at the moment of detection, covered an area of 0.5 hectares. From an aerial surveillance, it was estimated that the fire was spreading at a rate of increase in area of 2% per hour. If the area of the fire at time t hours is denoted by A hectares:
- Write down the differential equation that relates $\frac{dA}{dt}$ and A .
 - What would be the area of the fire 10 hours after it is first detected?
 - When would the fire cover an area of 3 hectares (to the nearest quarter-hour)?
- 18** A flexible beam is supported at its ends, which are at the same horizontal level and at a distance L apart. The deflection, y , of the beam, measured downwards from the horizontal through the supports, satisfies the differential equation

$$16 \frac{d^2y}{dx^2} = L - 3x, \quad 0 \leq x \leq L$$

where x is the horizontal distance from one end. Find where the deflection has its greatest magnitude, and also the value of this magnitude.

- 19** A vessel in the shape of a right circular cone has a vertical axis and a semi-vertex angle of 30° . There is a small hole at the vertex so that liquid leaks out at the rate of $0.05\sqrt{h}$ m^3 per hour, where h m is the depth of liquid in the vessel at time t hours. Given that the liquid is poured into this vessel at a constant rate of 2 m^3 per hour, set up (but do not attempt to solve) a differential equation for h .

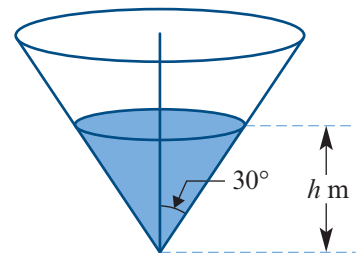

Multiple-choice questions



- 1** The acceleration, a m/s², of an object moving in a straight line at time t seconds is given by $a = \sin(2t)$. If the object has an initial velocity of 4 m/s, then v is equal to
- A** $2 \cos(2t) + 4$ **B** $2 \cos(2t) + 2$ **C** $\int_0^t \sin(2x) dx + 4$
D $-\frac{1}{2} \cos(2t) + 4$ **E** $\int_0^t \sin(2x) dx - 4$
- 2** If $f'(x) = x^2 - 1$ and $f(1) = 3$, an approximate value of $f(1.4)$ using Euler's method with a step size of 0.2 is
- A** 3.88 **B** 3.688 **C** 3.6 **D** 3.088 **E** 3
- 3** Euler's method with a step size of 0.1 is used to approximate the solution of the differential equation $\frac{dy}{dx} = x \ln x$ with $y(2) = 2$. When $x = 2.2$, the value obtained for y is closest to
- A** 2.314 **B** 2.294 **C** 2.291 **D** 2.287 **E** 2.277
- 4** Assume that $\frac{dy}{dx} = \frac{2-y}{4}$ and that $x = 3$ when $y = 1$. The value of x when $y = \frac{1}{2}$ is given by
- A** $x = \int_1^{\frac{1}{2}} \frac{4}{2-t} dt + 3$ **B** $x = \int_3^{\frac{1}{2}} \frac{4}{2-t} dt + 1$ **C** $x = \int_1^{\frac{1}{2}} \frac{2-t}{4} dt + 3$
D $x = \int_3^{\frac{1}{2}} \frac{2-t}{4} dt + 1$ **E** $x = \int_1^{\frac{1}{2}} \frac{2-y}{4} dy + 3$
- 5** If $\frac{dy}{dx} = \frac{2x+1}{4}$ and $y = 0$ when $x = 2$, then y is equal to
- A** $\frac{1}{4}(x^2 + x) + \frac{1}{2}$ **B** $\frac{x(x+1)}{4}$ **C** $\frac{1}{4}(x^2 + x) + 2$
D $\frac{1}{4}(x^2 + x - 1)$ **E** $\frac{1}{4}(x^2 + x - 6)$
- 6** If $\frac{dy}{dx} = \frac{1}{5}(y-1)^2$ and $y = 0$ when $x = 0$, then y is equal to
- A** $\frac{5}{1-x} - 5$ **B** $1 + \frac{5}{x+5}$ **C** $\frac{x}{x+5}$ **D** $\frac{5}{x+5} - 1$ **E** $1 - \frac{5}{x}$
- 7** The solution of the differential equation $\frac{dy}{dx} = e^{-x^2}$, where $y = 4$ when $x = 1$, is
- A** $y = \int_1^4 e^{-x^2} dx$ **B** $y = \int_1^4 e^{-x^2} dx + 4$ **C** $y = \int_1^x e^{-u^2} du - 4$
D $y = \int_1^x e^{-u^2} du + 4$ **E** $y = \int_4^x e^{-u^2} du + 1$
- 8** For which one of the following differential equations is $y = 2xe^{2x}$ a solution?
- A** $\frac{dy}{dx} - 2y = 0$ **B** $\frac{d^2y}{dx^2} - 2\frac{dy}{dx} = 0$ **C** $\frac{dy}{dx} + 2y\frac{dy}{dx} = 0$
D $\frac{d^2y}{dx^2} - 4y = e^{2x}$ **E** $\frac{d^2y}{dx^2} - 4y = 8e^{2x}$

- 9 Water is leaking from an initially full container with a depth of 40 cm. The volume, $V \text{ cm}^3$, of water in the container is given by $V = \pi(5h^2 + 225h)$, where $h \text{ cm}$ is the depth of the water at time t minutes.

If water leaks out at the rate of $\frac{5\sqrt{h}}{2h+45} \text{ cm}^3/\text{min}$, then the rate of change of the depth is

- A $\frac{-\sqrt{h}}{\pi(2h+45)^2} \text{ cm/min}$ B $5\pi(2h+45) \text{ cm/min}$ C $\frac{\sqrt{h}}{\pi(2h+45)^2} \text{ cm/min}$
 D $\frac{1}{5\pi(2h+45)} \text{ cm/min}$ E $\frac{-1}{5\pi(2h+45)} \text{ cm/min}$

- 10 The solution of the differential equation $\frac{dy}{dx} = y$, where $y = 2$ when $x = 0$, is

- A $y = e^{2x}$ B $y = e^{\frac{x}{2}}$ C $y = 2e^x$ D $y = \frac{1}{2}e^x$ E $y = \ln\left(\frac{x}{2}\right)$

- 11 The rate at which a particular disease spreads through a population of 2000 cattle is proportional to the product of the number of infected cows and the number of non-infected cows. Initially four cows are infected. If N denotes the number of infected cows at time t days, then a differential equation to describe this is

- A $\frac{dN}{dt} = kN(2000 - N)$ B $\frac{dN}{dt} = k(4 - N)(200 - N)$ C $\frac{dN}{dt} = kN(200 - N)$
 D $\frac{dN}{dt} = kN^2(2000 - N^2)$ E $\frac{dN}{dt} = \frac{k(2000 - N)}{2000}$

- 12 Consider the differential equation $\frac{dy}{dx} = \frac{1}{x^2 + 2x + 2}$ with $y_0 = 2$ and $x_0 = 0$. Using Euler's method with a step size of 0.1, the value of y_2 , correct to three decimal places, is

- A 2.123 B 2.675 C 2.567 D 1.987 E 2.095

- 13 The differential equation that best matches the slope field shown is

- A $\frac{dy}{dx} = x$ B $\frac{dy}{dx} = -x$ C $\frac{dy}{dx} = x^2$
 D $\frac{dy}{dx} = -x^2$ E $\frac{dy}{dx} = \frac{x}{y}$

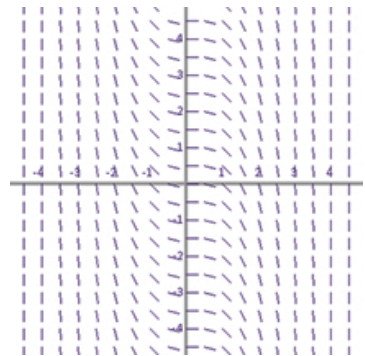

- 14 The amount of a salt Q in a tank at time t is given by the differential equation

$$\frac{dQ}{dt} = 3 - \frac{5}{5-t} \quad \text{with} \quad Q_0 = Q(0) = 10$$

Using Euler's method with a step size of 0.5 in the values of t , the value of Q correct to three decimal places when $t = 1$ is

- A 12.123 B 9.675 C 8.967 D 10.587 E 11.944

- 15** Water containing 3 grams of salt per litre flows at the rate of 20 litres per minute into a tank that initially contained 100 litres of pure water. The concentration of salt in the tank is kept uniform by stirring, and the mixture flows out of the tank at the rate of 10 litres per minute. If M grams is the amount of salt in the tank t minutes after the water begins to flow, the differential equation relating M to t is

A $\frac{dM}{dt} = 60 - \frac{10M}{100 - 10t}$ **B** $\frac{dM}{dt} = 3 - \frac{10M}{100 - 10t}$ **C** $\frac{dM}{dt} = 60 - \frac{10M}{100 + 10t}$
D $\frac{dM}{dt} = 20 - 10t$ **E** $\frac{dM}{dt} = -\frac{10M}{100 + 10t}$

- 16** The differential equation that best matches the slope field shown is

A $\frac{dy}{dx} = \frac{y}{x}$ **B** $\frac{dy}{dx} = -\frac{x^2}{y}$
C $\frac{dy}{dx} = \frac{x - 2y}{2y + x}$ **D** $\frac{dy}{dx} = -\frac{y}{x}$
E $\frac{dy}{dx} = \frac{x}{y}$

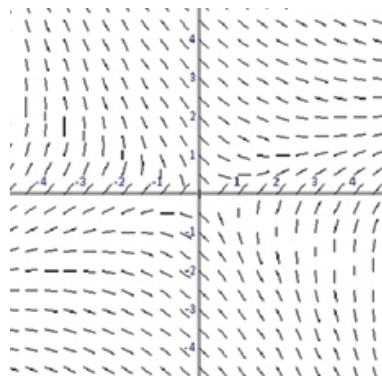

Extended-response questions

- 1** The percentage of radioactive carbon-14 in living matter decays, from the time of death, at a rate proportional to the percentage present.
- If $x\%$ is present t years after death:
 - Construct an appropriate differential equation.
 - Solve the differential equation, given that carbon-14 has a half-life of 5760 years, i.e. 50% of the original amount will remain after 5760 years.
 - Carbon-14 was taken from a tree buried by volcanic ash and was found to contain 45.1% of the amount of carbon-14 present in living timber. How long ago did the eruption occur?
 - Sketch the graph of x against t .
- 2** Two chemicals, A and B , are put together in a solution, where they react to form a compound, X . The rate of increase of the mass, x kg, of X is proportional to the product of the masses of *unreacted* A and B present at time t minutes. It takes 1 kg of A and 3 kg of B to form 4 kg of X . Initially, 2 kg of A and 3 kg of B are put together in solution, and 1 kg of X forms in 1 minute.
- Set up the appropriate differential equation expressing $\frac{dx}{dt}$ as a function of x .
 - Solve the differential equation.
 - Find the time taken to form 2 kg of X .
 - Find the mass of X formed after 2 minutes.

- 3** Newton's law of cooling states that the rate of cooling of a body is proportional to the excess of its temperature above that of its surroundings. The body has a temperature of $T^\circ\text{C}$ at time t minutes, while the temperature of the surroundings is a constant $T_s^\circ\text{C}$.
- Construct a differential equation expressing $\frac{dT}{dt}$ as a function of T .
 - A teacher pours a cup of coffee at lunchtime. The lunchroom is at a constant temperature of 22°C , while the coffee is initially 72°C . The coffee becomes undrinkable (too cold) when its temperature drops below 50°C . After 5 minutes, the temperature of the coffee has fallen to 65°C . Find correct to one decimal place:
 - the length of time, after it was poured, that the coffee remains drinkable
 - the temperature of the coffee at the end of 30 minutes.
- 4** On a cattle station there were p head of cattle at time t years after 1 January 2005. The population naturally increases at a rate proportional to p . Every year 1000 head of cattle are withdrawn from the herd.
- Show that $\frac{dp}{dt} = kp - 1000$, where k is a constant.
 - If the herd initially had 5000 head of cattle, find an expression for t in terms of k and p .
 - The population increased to 6000 head of cattle after 5 years.
 - Show that $5k = \ln\left(\frac{6k-1}{5k-1}\right)$.
 - Use a CAS calculator to find an approximation for the value of k .
 - Sketch a graph of p against t .
- 5** In the main lake of a trout farm, the trout population is N at time t days after 1 January 2015. The number of trout harvested on a particular day is proportional to the number of trout in the lake at that time. Every day 100 trout are added to the lake.
- Construct a differential equation with $\frac{dN}{dt}$ in terms of N and k , where k is a constant.
 - Initially the trout population was 1000. Find an expression for t in terms of k and N .
 - The trout population decreases to 700 after 10 days. Use a CAS calculator to find an approximation for the value of k .
 - Sketch a graph of N against t .
 - If the procedure at the farm remains unchanged, find the eventual trout population in the lake.
- 6** A thin horizontal beam, AB , of length L cm, is bent under a load so that the deflection, y cm at a point x cm from the end A , satisfies the differential equation
- $$\frac{d^2y}{dx^2} = \frac{9}{40L^2}(3x - L), \quad 0 \leq x \leq L$$
- Given that the deflection of the beam and its inclination to the horizontal are both zero at A , find:
- where the maximum deflection occurs
 - the magnitude of the maximum deflection.

- 7** The water in a hot-water tank cools at a rate which is proportional to $T - T_0$, where $T^\circ\text{C}$ is the temperature of the water at time t minutes and $T_0^\circ\text{C}$ is the temperature of the surrounding air. When T is 60, the water is cooling at 1°C per minute. When switched on, the heater supplies sufficient heat to raise the water temperature by 2°C each minute (neglecting heat loss by cooling). If $T = 20$ when the heater is switched on and $T_0 = 20$:
- Construct a differential equation for $\frac{dT}{dt}$ as a function of T (where both heating and cooling are taking place).
 - Solve the differential equation.
 - Find the temperature of the water 30 minutes after turning on the heater.
 - Sketch the graph of T against t .
- 8**
- The rate of growth of a population of iguanas on an island is $\frac{dW}{dt} = 0.04W$, where W is the number of iguanas alive after t years. Initially there were 350 iguanas.
 - Solve the differential equation.
 - Sketch the graph of W against t .
 - Give the value of W to the nearest integer when $t = 50$.
 - If $\frac{dW}{dt} = kW$ and there are initially 350 iguanas, find the value of k for which the population remains constant.
 - A more realistic population model for the iguanas is determined by the logistic differential equation $\frac{dW}{dt} = (0.04 - 0.00005W)W$. Initially there were 350 iguanas.
 - Solve the differential equation.
 - Sketch the graph of W against t .
 - Find the population after 50 years.
- 9** A hospital patient is receiving a drug at a constant rate of R mg per hour through a drip. At time t hours, the amount of the drug in the patient is x mg. The rate of loss of the drug from the patient is proportional to x .
- When $t = 0$, $x = 0$:
 - Show that $\frac{dx}{dt} = R - kx$, where k is a positive constant.
 - Find an expression for x in terms of t , k and R .
 - If $R = 50$ and $k = 0.05$:
 - Sketch the graph of x against t .
 - Find the time taken for there to be 200 mg in the patient, correct to two decimal places.
 - When the patient contains 200 mg of the drug, the drip is disconnected.
 - Assuming that the rate of loss remains the same, find the time taken for the amount of the drug in the patient to fall to 100 mg, correct to two decimal places.
 - Sketch the graph of x against t , showing the rise to 200 mg and fall to 100 mg.



14

Kinematics

Objectives

- ▶ To model **motion in a straight line**.
- ▶ To use **calculus** to solve problems involving motion in a straight line with constant or variable acceleration.
- ▶ To use **graphical methods** to solve problems involving motion in a straight line.
- ▶ To use techniques for solving **differential equations** to solve problems of the form

$$v = f(x), \quad a = f(v) \quad \text{and} \quad a = f(x)$$

where x , v and a represent position, velocity and acceleration respectively.

- ▶ To solve problems involving **simple harmonic motion**.

Kinematics is the study of motion without reference to the cause of motion.

In this chapter, we will consider the motion of a particle in a straight line. When referring to the motion of a particle, we may in fact be referring to an object of any size. However, for the purposes of studying its motion, we can assume that all forces acting on the object, causing it to move, are acting through a single point. Hence we can consider the motion of a car or a train in the same way as we would consider the motion of a dimensionless particle.

When studying motion, it is important to make a distinction between vector quantities and scalar quantities:

Vector quantities Position, displacement, velocity and acceleration must be specified by both magnitude and direction.

Scalar quantities Distance, speed and time are specified by their magnitude only.

Since we are considering movement in a straight line, the **direction** of each vector quantity is simply specified by the **sign** of the numerical value.

14A Position, velocity and acceleration

► Position

The **position** of a particle moving in a straight line is determined by its distance from a fixed point O on the line, called the **origin**, and whether it is to the right or left of O . By convention, the direction to the right of the origin is considered to be positive.



Consider a particle which starts at O and begins to move. The position of the particle at any instant can be specified by a real number x . For example, if the unit is metres and if $x = -3$, the position is 3 m to the left of O ; while if $x = 3$, the position is 3 m to the right of O .

Sometimes there is a rule that enables the position at any instant to be calculated. In this case, we can view x as being a function of t . Hence $x(t)$ is the position at time t .

For example, imagine that a stone is dropped from the top of a vertical cliff 45 metres high. Assume that the stone is a particle travelling in a straight line. Let $x(t)$ metres be the downwards position of the particle from O , the top of the cliff, t seconds after the particle is dropped. If air resistance is neglected, then an approximate model for the position is

$$x(t) = 5t^2 \quad \text{for } 0 \leq t \leq 3$$

Example 1

A particle moves in a straight line so that its position, x cm, relative to O at time t seconds is given by $x = t^2 - 7t + 6$, $t \geq 0$.

- a** Find its initial position. **b** Find its position at $t = 4$.

Solution

a At $t = 0$, $x = +6$, i.e. the particle is 6 cm to the right of O .

b At $t = 4$, $x = (4)^2 - 7(4) + 6 = -6$, i.e. the particle is 6 cm to the left of O .

► Displacement and distance

The **displacement** of a particle is defined as the change in position of the particle.

It is important to distinguish between the scalar quantity **distance** and the vector quantity displacement (which has a direction). For example, consider a particle that starts at O and moves first 5 units to the right to point P , and then 7 units to the left to point Q .

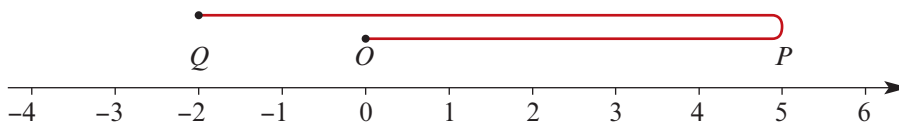

The difference between its final position and its initial position is -2 . So the displacement of the particle is -2 units. However, the distance it has travelled is 12 units.

► Velocity and speed

You are already familiar with rates of change through your studies in Mathematical Methods.

Average velocity

The average rate of change of position with respect to time is **average velocity**.

A particle's average velocity for a time interval $[t_1, t_2]$ is given by

$$\text{average velocity} = \frac{\text{change in position}}{\text{change in time}} = \frac{x_2 - x_1}{t_2 - t_1}$$

where x_1 is the position at time t_1 and x_2 is the position at time t_2 .

Instantaneous velocity

The instantaneous rate of change of position with respect to time is **instantaneous velocity**.

We will refer to the instantaneous velocity as simply the **velocity**.

If a particle's position, x , at time t is given as a function of t , then the velocity of the particle at time t is determined by differentiating the rule for position with respect to time.

If x is the position of a particle at time t , then

$$\text{velocity } v = \frac{dx}{dt}$$

Note: Velocity is also denoted by \dot{x} or $\dot{x}(t)$.

Velocity is a vector quantity. For motion in a straight line, the direction is specified by the sign of the numerical value.

If the velocity is positive, the particle is moving to the right, and if it is negative, the particle is moving to the left. A velocity of zero means the particle is instantaneously at rest.

Speed and average speed

Speed is a scalar quantity; its value is always non-negative.

- **Speed** is the magnitude of the velocity.
- **Average speed** for a time interval $[t_1, t_2]$ is given by $\frac{\text{distance travelled}}{t_2 - t_1}$

Units of measurement

Common units for velocity (and speed) are:

$$1 \text{ metre per second} = 1 \text{ m/s} = 1 \text{ m s}^{-1}$$

$$1 \text{ centimetre per second} = 1 \text{ cm/s} = 1 \text{ cm s}^{-1}$$

$$1 \text{ kilometre per hour} = 1 \text{ km/h} = 1 \text{ km h}^{-1}$$

The first and third units are connected in the following way:

$$1 \text{ km/h} = 1000 \text{ m/h} = \frac{1000}{60 \times 60} \text{ m/s} = \frac{5}{18} \text{ m/s}$$

$$\therefore 1 \text{ m/s} = \frac{18}{5} \text{ km/h}$$

Example 2

A particle moves in a straight line so that its position, x cm, relative to O at time t seconds is given by $x = 3t - t^3$, for $t \geq 0$. Find:

- | | |
|---------------------------------|---|
| a its initial position | b its position when $t = 2$ |
| c its initial velocity | d its velocity when $t = 2$ |
| e its speed when $t = 2$ | f when and where the velocity is zero. |

Solution

- a** When $t = 0$, $x = 0$. The particle is initially at O .
- b** When $t = 2$, $x = 3 \times 2 - 8 = -2$. The particle is 2 cm to the left of O .
- c** Given $x = 3t - t^3$, the velocity is

$$v = \frac{dx}{dt} = 3 - 3t^2$$

When $t = 0$, $v = 3 - 3 \times 0 = 3$.

The velocity is 3 cm/s. The particle is initially moving to the right.

- d** When $t = 2$, $v = 3 - 3 \times 4 = -9$.
- The velocity is -9 cm/s. The particle is moving to the left.
- e** When $t = 2$, the speed is 9 cm/s. (The speed is the magnitude of the velocity.)
- f** $v = 0$ implies $3 - 3t^2 = 0$

$$3(1 - t^2) = 0$$

$$\therefore t = 1 \text{ or } t = -1$$

But $t \geq 0$ and so $t = 1$. When $t = 1$, $x = 3 \times 1 - 1 = 2$.

At time $t = 1$ second, the particle is at rest 2 cm to the right of O .

Note: The motion of the particle can now be shown on a number line.

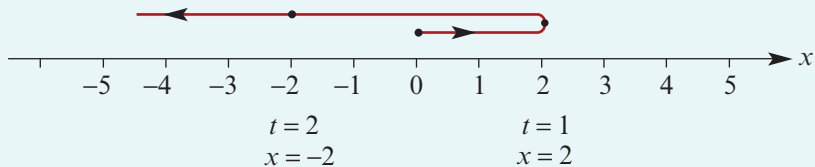

Example 3

The motion of a particle moving along a straight line is defined by $x(t) = t^2 - t$, where x m is the position of the particle relative to O at time t seconds ($t \geq 0$). Find:

- the average velocity of the particle in the first 3 seconds
- the distance travelled by the particle in the first 3 seconds
- the average speed of the particle in the first 3 seconds.

Solution

$$\begin{aligned} \text{a Average velocity} &= \frac{x(3) - x(0)}{3} \\ &= \frac{6 - 0}{3} \\ &= 2 \text{ m/s} \end{aligned}$$

- b** To find the distance travelled in the first 3 seconds, it is useful to show the motion of the particle on a number line. The critical points are where it starts and where and when it changes direction.

The particle starts at the origin. The turning points occur when the velocity is zero.

We have $v = \frac{dx}{dt} = 2t - 1$. Therefore $v = 0$ when $t = \frac{1}{2}$.

The particle changes direction when $t = \frac{1}{2}$ and $x = (\frac{1}{2})^2 - \frac{1}{2} = -\frac{1}{4}$.

When $0 \leq t < \frac{1}{2}$, v is negative and when $t > \frac{1}{2}$, v is positive.

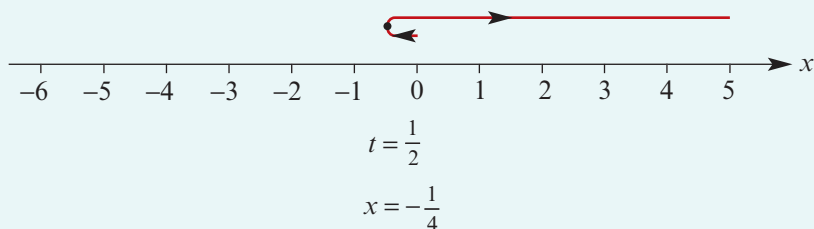

From the number line, the particle travels a distance of $\frac{1}{4}$ m in the first $\frac{1}{2}$ second. It then changes direction. When $t = 3$, the particle's position is $x(3) = 6$ m to the right of O , so the particle has travelled a distance of $6 + \frac{1}{4} = 6\frac{1}{4}$ m from when it changed direction.

The total distance travelled by the particle in the first 3 seconds is $\frac{1}{4} + 6\frac{1}{4} = 6\frac{1}{2}$ m.

$$\begin{aligned} \text{c Average speed} &= \frac{\text{distance travelled}}{\text{time taken}} \\ &= 6\frac{1}{2} \div 3 \\ &= \frac{13}{2} \div 3 \\ &= \frac{13}{6} \text{ m/s} \end{aligned}$$

► Acceleration

The acceleration of a particle is the rate of change of its velocity with respect to time.

- **Average acceleration** for the time interval $[t_1, t_2]$ is given by $\frac{v_2 - v_1}{t_2 - t_1}$, where v_2 is the velocity at time t_2 and v_1 is the velocity at time t_1 .
- **Instantaneous acceleration** $a = \frac{dv}{dt} = \frac{d}{dt}\left(\frac{dx}{dt}\right) = \frac{d^2x}{dt^2}$

Note: The second derivative $\frac{d^2x}{dt^2}$ is also denoted by \ddot{x} or $\ddot{x}(t)$.

Acceleration may be positive, negative or zero. Zero acceleration means the particle is moving at a constant velocity.

The direction of motion and the acceleration need not coincide. For example, a particle may have a positive velocity, indicating it is moving to the right, but a negative acceleration, indicating it is slowing down.

Also, although a particle may be instantaneously at rest, its acceleration at that instant need not be zero. If acceleration has the same sign as velocity, then the particle is ‘speeding up’. If the sign is opposite, the particle is ‘slowing down’.

The most commonly used units for acceleration are cm/s^2 and m/s^2 .

Example 4

An object travelling in a horizontal line has position x metres, relative to an origin O , at time t seconds, where $x = -4t^2 + 8t + 12$, $t \geq 0$.

- a Sketch the position–time graph, showing key features.
- b Find the velocity at time t seconds and sketch the velocity–time graph.
- c Find the acceleration at time t seconds and sketch the acceleration–time graph.
- d Represent the motion of the object on a number line.
- e Find the displacement of the object in the third second.
- f Find the distance travelled in the first 3 seconds.

Solution

a $x = -4t^2 + 8t + 12$, for $t \geq 0$

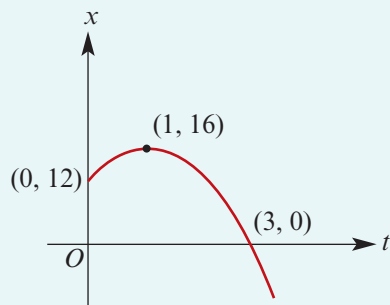

$$\mathbf{b} \quad v = \frac{dx}{dt} = -8t + 8, \text{ for } t \geq 0$$

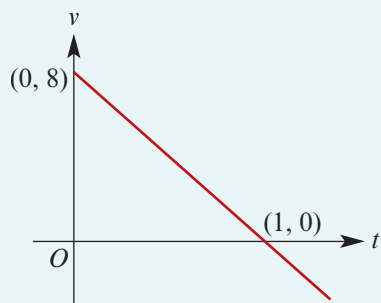

When $t \in [0, 1)$, the velocity is positive.

When $t > 1$, the velocity is negative.

$$\mathbf{c} \quad a = \frac{dv}{dt} = -8, \text{ for } t \geq 0$$

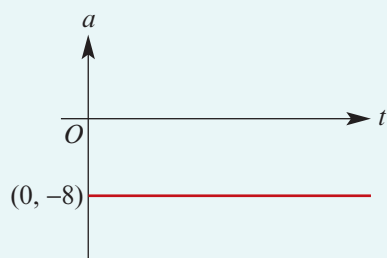

The acceleration is -8 m/s^2 .

The direction of the acceleration is always to the left.

\mathbf{d} Starting point: When $t = 0$, $x = 12$.

Turning point: When $v = -8t + 8 = 0$, $t = 1$ and $x = 16$.

When $0 \leq t < 1$, $v > 0$ and when $t > 1$, $v < 0$. That is, when $0 \leq t < 1$, the object is moving to the right, and when $t > 1$, the object is moving to the left.

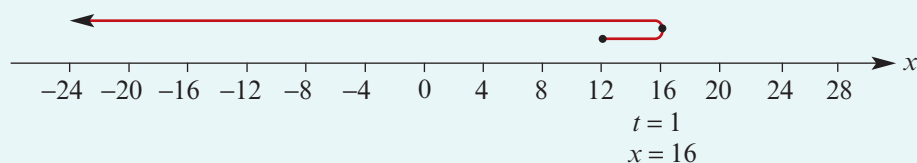

\mathbf{e} The displacement of the object in the third second is given by

$$\begin{aligned} x(3) - x(2) &= 0 - 12 \\ &= -12 \end{aligned}$$

The displacement is 12 metres to the left.

\mathbf{f} From the position–time graph in **a**, the distance travelled in the first 3 seconds is $4 + 16 = 20 \text{ m}$.



Example 5

An object moves in a horizontal line such that its position, x m, relative to a fixed point at time t seconds is given by $x = -t^3 + 3t + 2$, $t \geq 0$. Find:

- when the position is zero, and the velocity and acceleration at that time
- when the velocity is zero, and the position and acceleration at that time
- when the acceleration is zero, and the position and velocity at that time
- the distance travelled in the first 3 seconds.

Solution

$$\text{Now } x = -t^3 + 3t + 2$$

$$v = \dot{x} = -3t^2 + 3$$

$$a = \ddot{x} = -6t$$

(The acceleration is variable in this case.)

a $x = 0$ when $-t^3 + 3t + 2 = 0$

$$t^3 - 3t - 2 = 0$$

$$(t - 2)(t + 1)^2 = 0$$

Therefore $t = 2$, since $t \geq 0$.

At $t = 2$, $v = -3 \times 2^2 + 3 = -9$.

At $t = 2$, $a = -6 \times 2 = -12$.

When the position is zero, the velocity is -9 m/s and the acceleration is -12 m/s².

b $v = 0$ when $-3t^2 + 3 = 0$

$$t^2 = 1$$

Therefore $t = 1$, since $t \geq 0$.

At $t = 1$, $x = -1^3 + 3 \times 1 + 2 = 4$.

At $t = 1$, $a = -6 \times 1 = -6$.

When the object is at rest, the position is 4 m and the acceleration is -6 m/s².

c $a = 0$ when $-6t = 0$

$$\therefore t = 0$$

At $t = 0$, $x = 2$ and $v = 3$.

When the object has zero acceleration, the position is 2 m and the velocity is 3 m/s.

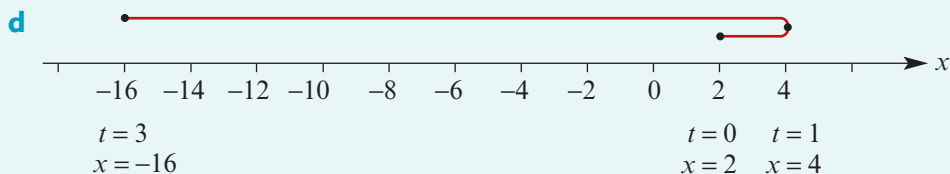

The distance travelled is $2 + 4 + 16 = 22$ metres.

► Using antidifferentiation

In the previous examples, we were given a rule for the position of a particle in terms of time, and from it we derived rules for the velocity and the acceleration by differentiation.

We may be given a rule for the acceleration at time t and, by using antidifferentiation with respect to t and some additional information, we can deduce rules for both velocity and position.



Example 6

The acceleration of a particle moving in a straight line, in m/s^2 , is given by

$$\frac{d^2y}{dt^2} = \cos(\pi t)$$

at time t seconds. The particle's initial velocity is 3 m/s and its initial position is $y = 6$. Find its position, y m, at time t seconds.

Solution

Find the velocity by antidifferentiating the acceleration:

$$\begin{aligned} \frac{dy}{dt} &= \int \frac{d^2y}{dt^2} dt \\ &= \int \cos(\pi t) dt \\ &= \frac{1}{\pi} \sin(\pi t) + c \end{aligned}$$

When $t = 0$, $\frac{dy}{dt} = 3$, so $c = 3$.

$$\therefore \frac{dy}{dt} = \frac{1}{\pi} \sin(\pi t) + 3$$

Antidifferentiating again:

$$\begin{aligned} y &= \int \frac{dy}{dt} dt \\ &= \int \left(\frac{1}{\pi} \sin(\pi t) + 3 \right) dt \\ &= -\frac{1}{\pi^2} \cos(\pi t) + 3t + d \end{aligned}$$

When $t = 0$, $y = 6$:

$$6 = -\frac{1}{\pi^2} + d$$

$$\therefore d = \frac{1}{\pi^2} + 6$$

$$\text{Hence } y = -\frac{1}{\pi^2} \cos(\pi t) + 3t + \frac{1}{\pi^2} + 6$$

Example 7

A cricket ball projected vertically upwards from ground level experiences a gravitational acceleration of 9.8 m/s^2 . If the initial speed of the cricket ball is 25 m/s , find:

- a** its speed after 2 seconds **b** its height after 2 seconds
c the greatest height **d** the time it takes to return to ground level.

Solution

A frame of reference is required. The path of the cricket ball is considered as a vertical straight line with origin O at ground level. Vertically up is taken as the positive direction.

We are given $a = -9.8$, $v(0) = 25$ and $x(0) = 0$.

$$\mathbf{a} \quad a = \frac{dv}{dt} = -9.8$$

$$v = \int \frac{dv}{dt} dt = \int -9.8 dt = -9.8t + c$$

Since $v(0) = 25$, we have $c = 25$ and therefore

$$v = -9.8t + 25$$

When $t = 2$, $v = -9.8 \times 2 + 25 = 5.4$.

The speed of the cricket ball is 5.4 m/s after 2 seconds.

$$\mathbf{b} \quad v = \frac{dx}{dt} = -9.8t + 25$$

$$x = \int -9.8t + 25 dt = -4.9t^2 + 25t + d$$

Since $x(0) = 0$, we have $d = 0$ and therefore

$$x = -4.9t^2 + 25t$$

When $t = 2$, $x = -19.6 + 50 = 30.4$.

The ball is 30.4 m above the ground after 2 seconds.

- c** The greatest height is reached when the ball is instantaneously at rest, i.e. when $v = -9.8t + 25 = 0$, which implies $t = \frac{25}{9.8}$.

$$\text{When } t = \frac{25}{9.8}, x = -4.9 \times \left(\frac{25}{9.8}\right)^2 + 25 \times \frac{25}{9.8} \approx 31.89.$$

The greatest height reached is 31.89 m .

- d** The cricket ball reaches the ground again when $x = 0$.

$$x = 0 \text{ implies } 25t - 4.9t^2 = 0$$

$$t(25 - 4.9t) = 0$$

$$\therefore t = 0 \text{ or } t = \frac{25}{4.9}$$

The ball returns to ground level after $\frac{25}{4.9} \approx 5.1$ seconds.

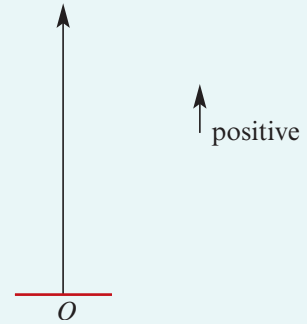



Example 8

A particle travels in a line such that its velocity, v m/s, at time t seconds is given by

$$v = 2 \cos\left(\frac{1}{2}t - \frac{\pi}{4}\right), \quad t \geq 0$$

The initial position of the particle is $-2\sqrt{2}$ m, relative to O .

- a**
- i** Find the particle's initial velocity.
 - ii** Find the particle's maximum and minimum velocities.
 - iii** For $0 \leq t \leq 4\pi$, find the times when the particle is instantaneously at rest.
 - iv** Determine the period of the motion.

Use this information to sketch the graph of velocity against time.

- b**
- i** Find the particle's position at time t .
 - ii** Find the particle's maximum and minimum position.
 - iii** Find when the particle first passes through the origin.
 - iv** Find the relation between the particle's velocity and position.

- c**
- i** Find the particle's acceleration at time t .
 - ii** Find the particle's maximum and minimum acceleration.
 - iii** Find the relation between the particle's acceleration and position.
 - iv** Find the relation between the particle's acceleration and velocity.

- d** Use the information obtained in **a–c** to describe the motion of the particle.

Solution

a i $v = 2 \cos\left(\frac{1}{2}t - \frac{\pi}{4}\right)$

At $t = 0$, $v = 2 \cos\left(-\frac{\pi}{4}\right) = \frac{2}{\sqrt{2}} = \sqrt{2}$ m/s.

- ii** By inspection, $v_{\max} = 2$ m/s and $v_{\min} = -2$ m/s.

- iii** $v = 0$ implies

$$\cos\left(\frac{1}{2}t - \frac{\pi}{4}\right) = 0$$

$$\frac{1}{2}t - \frac{\pi}{4} = \frac{\pi}{2}, \frac{3\pi}{2}, \dots$$

$$\frac{1}{2}t = \frac{3\pi}{4}, \frac{7\pi}{4}, \dots$$

$$t = \frac{3\pi}{2}, \frac{7\pi}{2}, \dots$$

For $0 \leq t \leq 4\pi$, the velocity is zero at $t = \frac{3\pi}{2}$ and $t = \frac{7\pi}{2}$.

- iv** The period of $v = 2 \cos\left(\frac{1}{2}t - \frac{\pi}{4}\right)$ is $2\pi \div \frac{1}{2} = 4\pi$ seconds.

$$v = 2 \cos\left(\frac{1}{2}t - \frac{\pi}{4}\right)$$

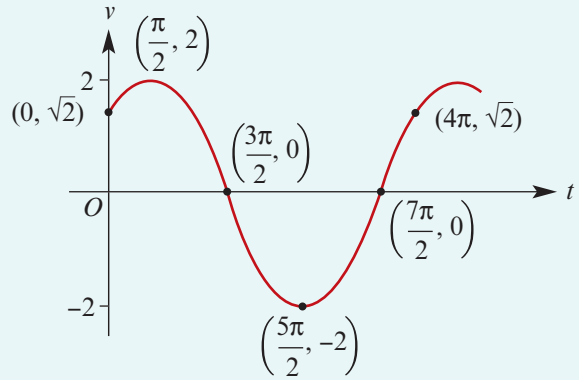

b i $x = \int v \, dt = \int 2 \cos\left(\frac{1}{2}t - \frac{\pi}{4}\right) dt$

Let $u = \frac{1}{2}t - \frac{\pi}{4}$. Then $\frac{du}{dt} = \frac{1}{2}$ and so

$$\begin{aligned} x &= 2 \int 2 \cos u \frac{du}{dt} dt \\ &= 4 \int \cos u \, du \\ &= 4 \sin u + c \end{aligned}$$

$$\therefore x = 4 \sin\left(\frac{1}{2}t - \frac{\pi}{4}\right) + c$$

Substituting $x = -2\sqrt{2}$ at $t = 0$:

$$-2\sqrt{2} = 4 \sin\left(-\frac{\pi}{4}\right) + c$$

$$-2\sqrt{2} = 4 \times \left(-\frac{1}{\sqrt{2}}\right) + c$$

$$\therefore c = 0$$

Hence $x = 4 \sin\left(\frac{1}{2}t - \frac{\pi}{4}\right)$

ii By inspection, $x_{\max} = 4$ m and $x_{\min} = -4$ m.

iii The particle passes through the origin when $x = 0$, which implies

$$\sin\left(\frac{1}{2}t - \frac{\pi}{4}\right) = 0$$

$$\frac{1}{2}t - \frac{\pi}{4} = 0, \pi, 2\pi, \dots$$

$$\frac{1}{2}t = \frac{\pi}{4}, \frac{5\pi}{4}, \frac{9\pi}{4}, \dots$$

$$\therefore t = \frac{\pi}{2}, \frac{5\pi}{2}, \frac{9\pi}{2}, \dots$$

Thus the particle first passes through the origin at $t = \frac{\pi}{2}$ seconds.

iv We have $v = 2 \cos\left(\frac{1}{2}t - \frac{\pi}{4}\right)$ and $x = 4 \sin\left(\frac{1}{2}t - \frac{\pi}{4}\right)$.

Using the Pythagorean identity:

$$\cos^2\left(\frac{1}{2}t - \frac{\pi}{4}\right) + \sin^2\left(\frac{1}{2}t - \frac{\pi}{4}\right) = 1$$

This gives

$$\begin{aligned} \left(\frac{v}{2}\right)^2 + \left(\frac{x}{4}\right)^2 &= 1 \\ \frac{v}{2} &= \pm \sqrt{1 - \frac{x^2}{16}} \\ \frac{v}{2} &= \pm \frac{1}{4} \sqrt{16 - x^2} \\ \therefore v &= \pm \frac{1}{2} \sqrt{16 - x^2} \end{aligned}$$

c i $a = \frac{dv}{dt} = \frac{d}{dt}\left(2 \cos\left(\frac{1}{2}t - \frac{\pi}{4}\right)\right)$

$$\therefore a = -\sin\left(\frac{1}{2}t - \frac{\pi}{4}\right) \quad (\text{using the chain rule})$$

ii By inspection, $a_{\max} = 1 \text{ m/s}^2$ and $a_{\min} = -1 \text{ m/s}^2$.

iii We have $a = -\sin\left(\frac{1}{2}t - \frac{\pi}{4}\right)$ and $x = 4 \sin\left(\frac{1}{2}t - \frac{\pi}{4}\right)$.

Therefore $a = -\frac{x}{4}$.

iv We have $a = -\sin\left(\frac{1}{2}t - \frac{\pi}{4}\right)$ and $v = 2 \cos\left(\frac{1}{2}t - \frac{\pi}{4}\right)$.

Using the Pythagorean identity again:

$$\begin{aligned} a^2 + \left(\frac{v}{2}\right)^2 &= 1 \\ a &= \pm \sqrt{1 - \frac{v^2}{4}} \\ \therefore a &= \pm \frac{1}{2} \sqrt{4 - v^2} \end{aligned}$$

- d** The particle oscillates between positions ± 4 m, relative to O , taking 4π seconds for each cycle. The particle's velocity oscillates between ± 2 m/s, and its acceleration oscillates between ± 1 m/s².

Maximum and minimum acceleration occurs when the particle is at the maximum distance from the origin; this is where the particle is instantaneously at rest.

Exercise 14A

Skillsheet

1 The position of a particle travelling in a horizontal line, relative to a point O on the line, is x metres at time t seconds. The position is described by $x = 3t - t^2$, $t \geq 0$.

Example 2, 3

- a** Find the position of the particle at times $t = 0, 1, 2, 3, 4$ and illustrate the motion of the particle on a number line.
- b** Find the displacement of the particle in the fifth second.
- c** Find the average velocity in the first 4 seconds.
- d** Find the relation between velocity, v m/s, and time, t s.
- e** Find the velocity of the particle when $t = 2.5$.
- f** Find when and where the particle changes direction.
- g** Find the distance travelled in the first 4 seconds.
- h** Find the particle's average speed for the first 4 seconds.

Example 4

2 An object travelling in a horizontal line has position x metres, relative to an origin O , at time t seconds, where $x = -3t^2 + 10t + 8$, $t \geq 0$.

- a** Sketch the position–time graph, showing key features.
- b** Find the velocity at time t seconds and sketch the velocity–time graph.
- c** Find the acceleration at time t seconds and sketch the acceleration–time graph.
- d** Represent the motion of the object on a number line for $0 \leq t \leq 6$.
- e** Find the displacement of the object in the third second.
- f** Find the distance travelled in the first 3 seconds.

Example 5

3 A particle travels in a straight line through a fixed point O . Its position, x metres, relative to O is given by $x = t^3 - 9t^2 + 24t$, $t \geq 0$, where t is the time in seconds after passing O . Find:

- a** the values of t for which the velocity is instantaneously zero
- b** the acceleration when $t = 5$
- c** the average velocity of the particle during the first 2 seconds
- d** the average speed of the particle during the first 4 seconds.

4 A particle moves in a straight line. Relative to a fixed point O on the line, the particle's position, x m, at time t seconds is given by $x = t(t - 3)^2$. Find:

- a** the velocity of the particle after 2 seconds
- b** the values of t for which the particle is instantaneously at rest
- c** the acceleration of the particle after 4 seconds.

5 A particle moving in a straight line has position given by $x = 2t^3 - 4t^2 - 100$. Find the time(s) when the particle has zero velocity.

- 6** A particle moving in a straight line passes through a fixed point O . Its velocity, v m/s, at time t seconds after passing O is given by $v = 4 + 3t - t^2$. Find:
- a** the maximum value of v **b** the distance of the particle from O when $t = 4$.
- 7** A particle moves in a straight line such that, at time t seconds after passing through a fixed point O , its velocity, v m/s, is given by $v = 3t^2 - 30t + 72$. Find:
- a** the initial acceleration of the particle
b the two values of t for which the particle is instantaneously at rest
c the distance moved by the particle during the interval between these two values
d the total distance moved by the particle between $t = 0$ and $t = 7$.
- 8** A particle moving in a straight line passes through a fixed point O with velocity 8 m/s. Its acceleration, a m/s², at time t seconds after passing O is given by $a = 12 - 6t$. Find:
- a** the velocity of the particle when $t = 2$
b the displacement of the particle from O when $t = 2$.

Example 6

- 9** A particle moving in a straight line passes through a fixed point O on the line with a velocity of 30 m/s. The acceleration, a m/s², of the particle at time t seconds after passing O is given by $a = 13 - 6t$. Find:
- a** the velocity of the particle 3 seconds after passing O
b the time taken to reach the maximum distance from O in the initial direction of motion
c the value of this maximum distance.

Example 7

- 10** An object is dropped down a well. It takes 2 seconds to reach the bottom. During its fall, the object travels under a gravitational acceleration of 9.8 m/s².
- a** Find an expression in terms of t for:
- i** the velocity, v m/s **ii** the position, x m, measured from the top of the well.
- b** Find the depth of the well.
c At what speed does the object hit the bottom of the well?

Example 8

- 11** An object travels in a line such that its velocity, v m/s, at time t seconds is given by $v = \cos\left(\frac{t}{2}\right)$, $t \in [0, 4\pi]$. The initial position of the object is 0.5 m, relative to O .
- a** Find an expression for the position, x m, of the object in terms of t .
b Sketch the position–time graph for the motion, indicating clearly the values of t at which the object is instantaneously at rest.
c Find an expression for the acceleration, a m/s², of the object in terms of t .
d Find a relation (not involving t) between:
- i** position and acceleration **ii** position and velocity
iii velocity and acceleration.

- 12** A particle moves horizontally in a line such that its position, x m, relative to O at time t seconds is given by $x = t^3 - \frac{15}{2}t^2 + 12t + 10$. Find:
- when and where the particle has zero velocity
 - the average velocity during the third second
 - the velocity at $t = 2$
 - the distance travelled in the first 2 seconds
 - the closest the particle comes to O .
- 13** An object moves in a line such that at time t seconds the acceleration, \ddot{x} m/s², is given by $\ddot{x} = 2 \sin\left(\frac{1}{2}t\right)$. The initial velocity is 1 m/s.
- Find the maximum velocity.
 - Find the time taken for the object to first reach the maximum velocity.
- 14** From a balloon ascending with a velocity of 10 m/s, a stone was dropped and reached the ground in 12 seconds. Given that the gravitational acceleration is 9.8 m/s², find:
- the height of the balloon when the stone was dropped
 - the greatest height reached by the stone.
- 15** An object moves in a line with acceleration, \ddot{x} m/s², given by $\ddot{x} = \frac{1}{(2t+3)^2}$. If the object starts from rest at the origin, find the position–time relationship.
- 16** A particle moves in a line with acceleration, \ddot{x} m/s², given by $\ddot{x} = \frac{2t}{(1+t^2)^2}$. If the initial velocity is 0.5 m/s, find the distance travelled in the first $\sqrt{3}$ seconds.
- 17** An object moves in a line with velocity, \dot{x} m/s, given by $\dot{x} = \frac{t}{1+t^2}$. The object starts from the origin. Find:
- the initial velocity
 - the maximum velocity
 - the distance travelled in the third second
 - the position–time relationship
 - the acceleration–time relationship
 - the average acceleration over the third second
 - the minimum acceleration.
- 18** An object moves in a horizontal line such that its position, x m, at time t seconds is given by $x = 2 + \sqrt{t+1}$. Find when the acceleration is -0.016 m/s².
- 19** A particle moves in a straight line such that the position, x metres, of the particle relative to a fixed origin at time t seconds is given by $x = 2 \sin t + \cos t$, for $t \geq 0$. Find the first value of t for which the particle is instantaneously at rest.
- 20** The acceleration of a particle moving in a straight line, in m/s², at time t seconds is given by $\frac{d^2x}{dt^2} = 8 - e^{-t}$. If the initial velocity is 3 m/s, find the velocity when $t = 2$.



14B Constant acceleration

If an object is moving due to a constant force (for example, gravity), then its acceleration is constant. There are several useful formulas that apply in this situation.

Formulas for constant acceleration

For a particle moving in a straight line with constant acceleration a , we can use the following formulas, where u is the initial velocity, v is the final velocity, s is the displacement and t is the time taken:

$$1 \quad v = u + at \qquad 2 \quad s = ut + \frac{1}{2}at^2 \qquad 3 \quad v^2 = u^2 + 2as \qquad 4 \quad s = \frac{1}{2}(u + v)t$$

Proof 1 We can write

$$\frac{dv}{dt} = a$$

where a is a constant and v is the velocity at time t . By antidifferentiating with respect to t , we obtain

$$v = at + c$$

where the constant c is the initial velocity. We denote the initial velocity by u , and therefore $v = u + at$.

2 We now write

$$\frac{dx}{dt} = v = u + at$$

where x is the position at time t . By antidifferentiating again, we have

$$x = ut + \frac{1}{2}at^2 + d$$

where the constant d is the initial position. The particle's displacement (change in position) is given by $s = x - d$, and so we obtain the second equation.

3 Transform the first equation $v = u + at$ to make t the subject:

$$t = \frac{v - u}{a}$$

Now substitute this into the second equation:

$$\begin{aligned} s &= ut + \frac{1}{2}at^2 \\ s &= \frac{u(v - u)}{a} + \frac{a(v - u)^2}{2a^2} \\ 2as &= 2u(v - u) + (v - u)^2 \\ &= 2uv - 2u^2 + v^2 - 2uv + u^2 \\ &= v^2 - u^2 \end{aligned}$$

4 Similarly, the fourth equation can be derived from the first and second equations.

These four formulas are very useful, but it must be remembered that they only apply when the acceleration is constant.

When approaching problems involving constant acceleration, it is a good idea to list the quantities you are given, establish which quantity or quantities you require, and then use the appropriate formula. Ensure that all quantities are converted to compatible units.

Example 9

An object is moving in a straight line with uniform acceleration. Its initial velocity is 12 m/s and after 5 seconds its velocity is 20 m/s. Find:

- a** the acceleration
- b** the distance travelled during the first 5 seconds
- c** the time taken to travel a distance of 200 m.

Solution

We are given $u = 12$, $v = 20$ and $t = 5$.

- a** Find a using

$$\begin{aligned} v &= u + at \\ 20 &= 12 + 5a \\ a &= 1.6 \end{aligned}$$

The acceleration is 1.6 m/s².

- b** Find s using

$$\begin{aligned} s &= ut + \frac{1}{2}at^2 \\ &= 12(5) + \frac{1}{2}(1.6)5^2 = 80 \end{aligned}$$

The distance travelled is 80 m.

Note: Since the object is moving in one direction, the distance travelled is equal to the displacement.

- c** We are now given $a = 1.6$, $u = 12$ and $s = 200$.

Find t using $s = ut + \frac{1}{2}at^2$

$$200 = 12t + \frac{1}{2} \times 1.6 \times t^2$$

$$200 = 12t + \frac{4}{5}t^2$$

$$1000 = 60t + 4t^2$$

$$250 = 15t + t^2$$

$$t^2 + 15t - 250 = 0$$

$$(t - 10)(t + 25) = 0$$

$$\therefore t = 10 \text{ or } t = -25$$

As $t \geq 0$, the only allowable solution is $t = 10$.

The object takes 10 s to travel a distance of 200 m.

Example 10

A body is moving in a straight line with uniform acceleration and an initial velocity of 12 m/s. If the body stops after 20 metres, find the acceleration of the body.

Solution

We are given $u = 12$, $v = 0$ and $s = 20$.

Find a using

$$v^2 = u^2 + 2as$$

$$0 = 144 + 2 \times a \times 20$$

$$0 = 144 + 40a$$

$$\therefore a = -\frac{144}{40}$$

The acceleration is $-\frac{18}{5} \text{ m/s}^2$.

Example 11

A stone is thrown vertically upwards from the top of a cliff which is 25 m high. The velocity of projection of the stone is 22 m/s. Find the time it takes to reach the base of the cliff. (Give answer correct to two decimal places.)

Solution

Take the origin at the top of the cliff and vertically upwards as the positive direction.

We are given $s = -25$, $u = 22$ and $a = -9.8$.

Find t using

$$s = ut + \frac{1}{2}at^2$$

$$-25 = 22t + \frac{1}{2} \times (-9.8) \times t^2$$

$$-25 = 22t - 4.9t^2$$

Therefore

$$4.9t^2 - 22t - 25 = 0$$

By the quadratic formula:

$$t = \frac{22 \pm \sqrt{22^2 - 4 \times 4.9 \times (-25)}}{2 \times 4.9}$$

$$\therefore t = 5.429 \dots \text{ or } t = -0.9396 \dots$$

But $t \geq 0$, so the only allowable solution is $t = 5.429 \dots$

It takes 5.43 seconds for the stone to reach the base of the cliff.

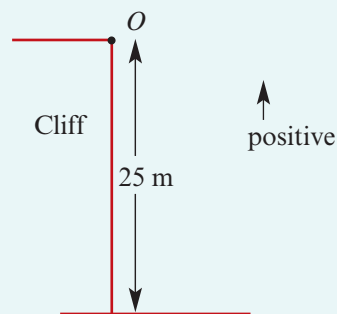

Exercise 14B**Skillsheet**

- 1** An object with constant acceleration starts with a velocity of 15 m/s. At the end of the eleventh second, its velocity is 48 m/s. What is its acceleration?
- 2** A car accelerates uniformly from 5 km/h to 41 km/h in 10 seconds. Express this acceleration in:
- a** km/h² **b** m/s²

Example 9

- 3** An object is moving in a straight line with uniform acceleration. Its initial velocity is 10 m/s and after 5 seconds its velocity is 25 m/s. Find:
- a** the acceleration
b the distance travelled during the first 5 seconds
c the time taken to travel a distance of 100 m.

Example 10

- 4** A body moving in a straight line has uniform acceleration and an initial velocity of 20 m/s. If the body stops after 40 metres, find the acceleration of the body.
- 5** A particle starts from a fixed point O with an initial velocity of -10 m/s and a uniform acceleration of 4 m/s². Find:
- a** the displacement of the particle from O after 6 seconds
b the velocity of the particle after 6 seconds
c the time when the velocity is zero
d the distance travelled in the first 6 seconds.

Example 11

- 6** **a** A stone is thrown vertically upwards from ground level at 21 m/s. The acceleration due to gravity is 9.8 m/s².
- i** What is its height above the ground after 2 seconds?
ii What is the maximum height reached by the stone?
- b** If the stone is thrown vertically upwards from a cliff 17.5 m high at 21 m/s:
- i** How long will it take to reach the ground at the base of the cliff?
ii What is the velocity of the stone when it hits the ground?
- 7** A basketball is thrown vertically upwards with a velocity of 14 m/s. The acceleration due to gravity is 9.8 m/s². Find:
- a** the time taken by the ball to reach its maximum height
b the greatest height reached by the ball
c the time taken for the ball to return to the point from which it is thrown.

- 8** A car sliding on ice is decelerating at the rate of 0.1 m/s^2 . Initially the car is travelling at 20 m/s . Find:
- a** the time taken before it comes to rest
 - b** the distance travelled before it comes to rest.
- 9** An object is dropped from a point 100 m above the ground. The acceleration due to gravity is 9.8 m/s^2 . Find:
- a** the time taken by the object to reach the ground
 - b** the velocity at which the object hits the ground.
- 10** An object is projected vertically upwards from a point 50 m above ground level. (Acceleration due to gravity is 9.8 m/s^2 .) If the initial velocity is 10 m/s , find:
- a** the time the object takes to reach the ground (correct to two decimal places)
 - b** the object's velocity when it reaches the ground.
- 11** A book is pushed across a table and is subjected to a retardation of 0.8 m/s^2 due to friction. (Retardation is acceleration in the opposite direction to motion.) If the initial speed of the book is 1 m/s , find:
- a** the time taken for the book to stop
 - b** the distance over which the book slides.
- 12** A box is pushed across a bench and is subjected to a constant retardation, $a \text{ m/s}^2$, due to friction. The initial speed of the box is 1.2 m/s and the box travels 3.2 m before stopping. Find:
- a** the value of a
 - b** the time taken for the box to come to rest.
- 13** A particle travels in a straight line with a constant velocity of 4 m/s for 12 seconds. It is then subjected to a constant acceleration in the opposite direction for 20 seconds, which returns the particle to its original position. Find the acceleration of the particle.
- 14** A child slides from rest down a slide 4 m long. The child undergoes constant acceleration and reaches the end of the slide travelling at 2 m/s . Find:
- a** the time taken to go down the slide
 - b** the acceleration which the child experiences.



14C Velocity–time graphs

Velocity–time graphs are valuable when considering motion in a straight line.

Information from a velocity–time graph

- **Acceleration** is given by the gradient.
- **Displacement** is given by the signed area bounded by the graph and the t -axis.
- **Distance travelled** is given by the total area bounded by the graph and the t -axis.

Example 12

A person walks east for 8 seconds at 2 m/s and then west for 4 seconds at 1.5 m/s. Sketch the velocity–time graph for this journey and find the displacement from the start of the walk and the total distance travelled.

Solution

The velocity–time graph is as shown.

Distance travelled to the east
 $= 8 \times 2 = 16 \text{ m}$

Distance travelled to the west
 $= 4 \times 1.5 = 6 \text{ m}$

Displacement (signed area)
 $= 8 \times 2 + 4 \times (-1.5) = 10 \text{ m}$

Distance travelled (total area)
 $= 8 \times 2 + 4 \times 1.5 = 22 \text{ m}$

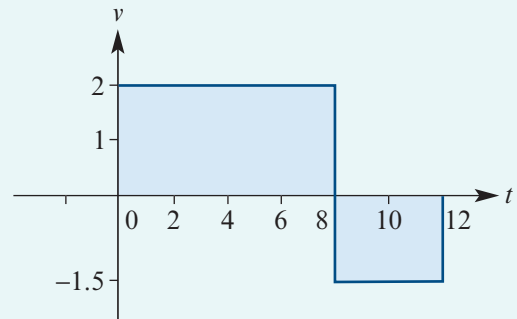

Consider a particle moving in a straight line with its motion described by the velocity–time graph shown opposite.

The shaded area represents the total distance travelled by the particle from $t = 0$ to $t = b$.

The signed area represents the displacement (change in position) of the particle for this time interval.

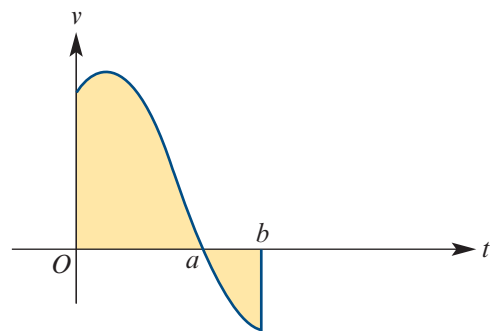

Using integral notation to describe the areas yields the following:

- Distance travelled over the time interval $[0, a]$ $= \int_0^a v(t) dt$
- Distance travelled over the time interval $[a, b]$ $= - \int_a^b v(t) dt$
- Total distance travelled over the time interval $[0, b]$ $= \int_0^a v(t) dt - \int_a^b v(t) dt$
- Displacement over the time interval $[0, b]$ $= \int_0^b v(t) dt$

Example 13

The graph shows the motion of a particle.

- a** Describe the motion.
b Find the distance travelled.

Velocity is measured in m/s and time in seconds.

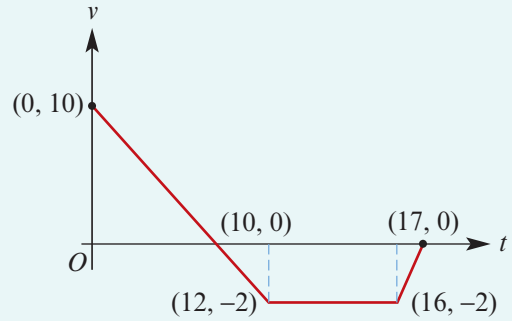
**Solution**

a The particle decelerates uniformly from an initial velocity of 10 m/s. After 10 seconds, it is instantaneously at rest before it accelerates uniformly in the opposite direction for 2 seconds, until its velocity reaches -2 m/s. It continues to travel in this direction with a constant velocity of -2 m/s for a further 4 seconds. Finally, it decelerates uniformly until it comes to rest after 17 seconds.

b Distance travelled $= \left(\frac{1}{2} \times 10 \times 10\right) + \left(\frac{1}{2} \times 2 \times 2\right) + (4 \times 2) + \left(\frac{1}{2} \times 1 \times 2\right)$
 $= 61$ m

Example 14

A car travels from rest for 10 seconds, with uniform acceleration, until it reaches a speed of 90 km/h. It then travels with this constant speed for 15 seconds and finally decelerates at a uniform 5 m/s² until it stops. Calculate the distance travelled from start to finish.

Solution

First convert the given speed to standard units:

$$90 \text{ km/h} = 90\,000 \text{ m/h} = \frac{90\,000}{3600} \text{ m/s} = 25 \text{ m/s}$$

Now sketch a velocity–time graph showing the given information.

The gradient of BC is -5 (deceleration):

$$\text{gradient} = \frac{25}{25 - c} = -5$$

$$-5(25 - c) = 25$$

$$-125 + 5c = 25$$

$$\therefore c = 30$$

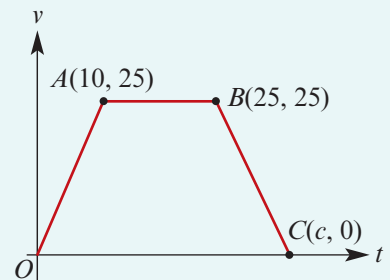

Now calculate the distance travelled using the area of trapezium $OABC$:

$$\text{area} = \frac{1}{2}(15 + 30) \times 25 = 562.5$$

The total distance travelled is 562.5 metres.

Example 15

A motorist is travelling at a constant speed of 120 km/h when he passes a stationary police car. He continues at that speed for another 15 s before uniformly decelerating to 100 km/h in 5 s. The police car takes off after the motorist the instant that he passes. It accelerates uniformly for 25 s, by which time it has reached 130 km/h. It continues at that speed until it catches up to the motorist. After how long does the police car catch up to the motorist and how far has he travelled in that time?

Solution

We start by representing the information on a velocity–time graph.

The distances travelled by the motorist and the police car will be the same, so the areas under the two velocity–time graphs will be equal.

This fact can be used to find T , the time taken for the police car to catch up to the motorist.

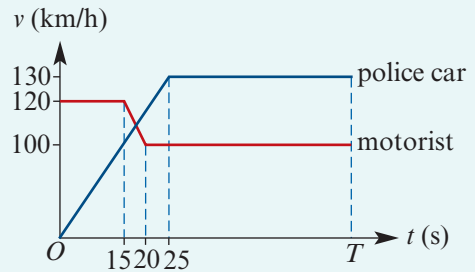

Note: The factor $\frac{5}{18}$ changes velocities from km/h to m/s.

The distances travelled (in metres) after T seconds are given by

$$\begin{aligned} \text{Distance for motorist} &= \frac{5}{18} \left(120 \times 15 + \frac{1}{2} (120 + 100) \times 5 + 100(T - 20) \right) \\ &= \frac{5}{18} (1800 + 550 + 100T - 2000) \\ &= \frac{5}{18} (100T + 350) \end{aligned}$$

$$\begin{aligned} \text{Distance for police car} &= \frac{5}{18} \left(\frac{1}{2} \times 25 \times 130 + 130(T - 25) \right) \\ &= \frac{5}{18} (130T - 1625) \end{aligned}$$

When the police car catches up to the motorist:

$$\begin{aligned} 100T + 350 &= 130T - 1625 \\ 30T &= 1975 \\ T &= \frac{395}{6} \end{aligned}$$

The police car catches up to the motorist after 65.83 s.

$$\begin{aligned} \therefore \text{Distance for motorist} &= \frac{5}{18} (100T + 350) \quad \text{where } T = \frac{395}{6} \\ &= \frac{52\,000}{27} \text{ m} \\ &= 1.926 \text{ km} \end{aligned}$$

The motorist has travelled 1.926 km when the police car catches up.

Example 16

An object travels in a line. Its acceleration decreases uniformly from 0 m/s^2 to -5 m/s^2 in 15 seconds. If the initial velocity was 24 m/s , find:

- a** the velocity at the end of the 15 seconds
b the distance travelled in the 15 seconds.

Solution

- a** The acceleration–time graph shows the uniform change in acceleration from 0 m/s^2 to -5 m/s^2 in 15 seconds.

From the graph, we can write $a = mt + c$.

But $m = \frac{-5}{15} = -\frac{1}{3}$ and $c = 0$, giving

$$a = -\frac{1}{3}t$$

$$\therefore v = -\frac{1}{6}t^2 + d$$

At $t = 0$, $v = 24$, so $d = 24$.

$$\therefore v = -\frac{1}{6}t^2 + 24$$

Now, at $t = 15$,

$$\begin{aligned} v &= -\frac{1}{6} \times 15^2 + 24 \\ &= -13.5 \end{aligned}$$

The velocity at 15 seconds is -13.5 m/s .

- b** To sketch the velocity–time graph, first find the t -axis intercepts:

$$-\frac{1}{6}t^2 + 24 = 0$$

$$\therefore t^2 = 144$$

$$\therefore t = 12 \quad (\text{since } t \geq 0)$$

The distance travelled is given by the area of the shaded region.

$$\begin{aligned} \text{Area} &= \int_0^{12} \left(-\frac{1}{6}t^2 + 24\right) dt + \left| \int_{12}^{15} \left(-\frac{1}{6}t^2 + 24\right) dt \right| \\ &= 192 + |-19.5| \\ &= 211.5 \end{aligned}$$

The distance travelled in 15 seconds is 211.5 metres.

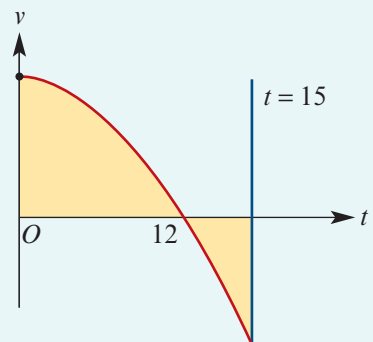
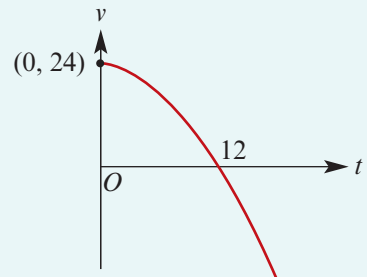
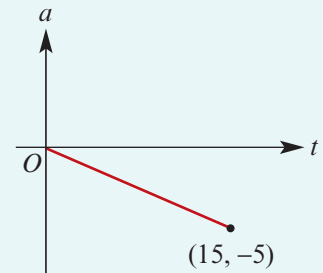

Exercise 14C

Skillsheet
Example 13

1 Each of the following graphs shows the motion of a particle. For each graph:

- i** describe the motion **ii** find the distance travelled.

Velocity is measured in m/s and time in seconds.

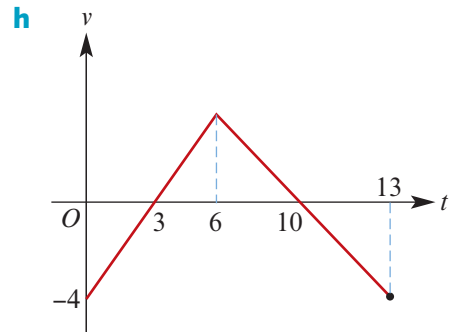
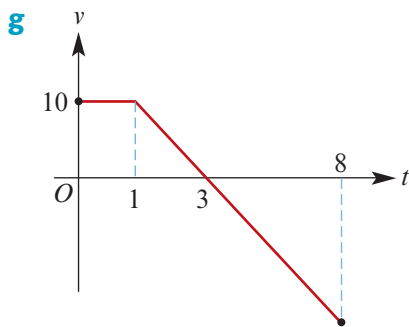
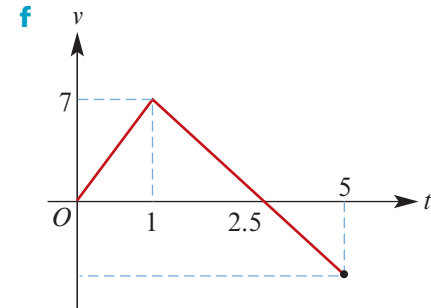
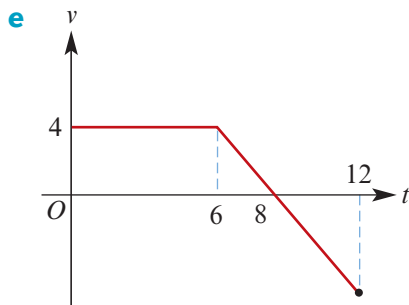
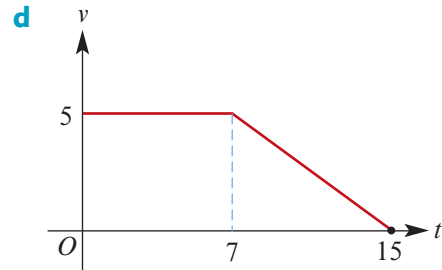
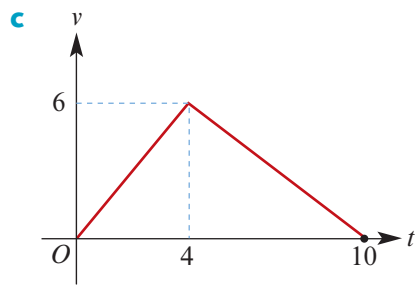
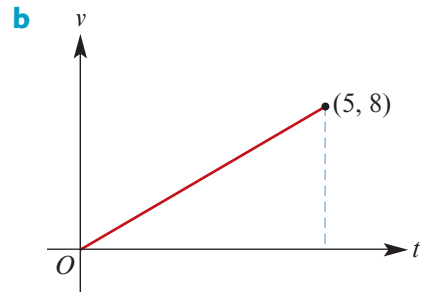
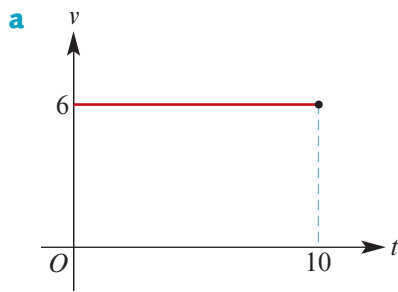

- 2** For each of the following velocity–time graphs, the object starts from the origin and moves in a line. In each case, find the relationship between time and:
- i** velocity **ii** acceleration **iii** position.

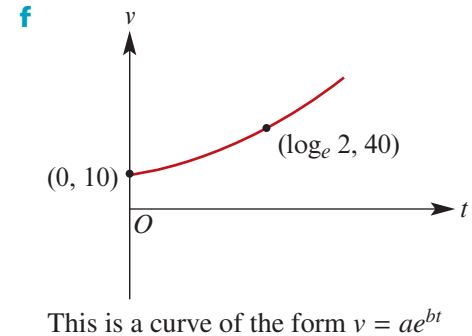
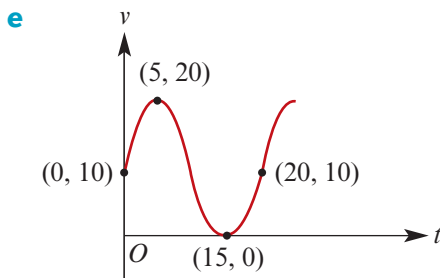
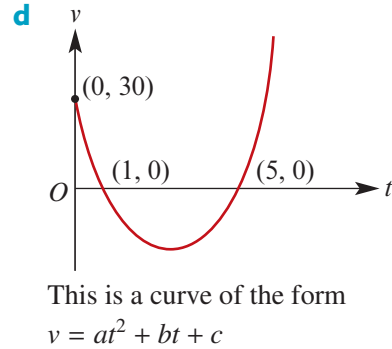
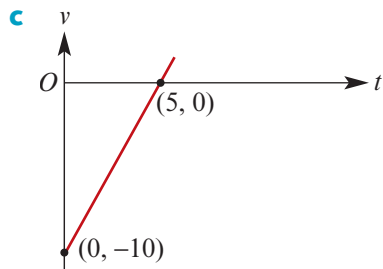
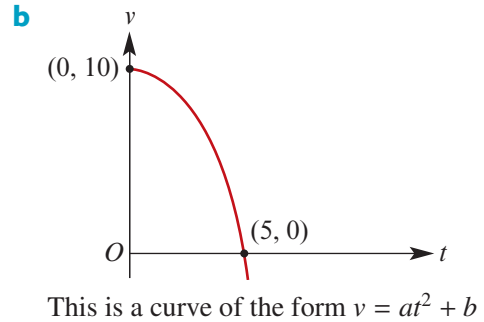
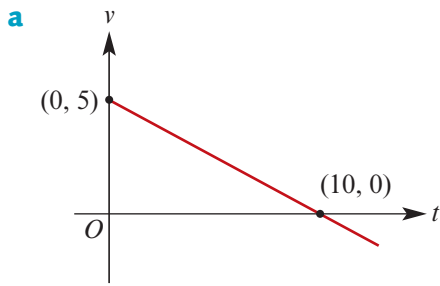

Example 14

- 3** A car travels from rest for 15 seconds, with uniform acceleration, until it reaches a speed of 100 km/h. It then travels with this constant speed for 120 seconds and finally decelerates at a uniform 8 m/s^2 until it stops. Calculate the total distance travelled.
- 4** A particle moves in a straight line with a constant velocity of 20 m/s for 10 seconds. It is then subjected to a constant acceleration of 5 m/s^2 in the opposite direction for T seconds, at which time the particle is back to its original position.
- a** Sketch the velocity–time graph representing the motion.
- b** Find how long it takes the particle to return to its original position.

14D Differential equations of the form $v = f(x)$ and $a = f(v)$

When we are given information about the motion of an object in one of the forms

$$v = f(x) \quad \text{or} \quad a = f(v)$$

we can apply techniques for solving differential equations to obtain other information about the motion.



Example 17

The velocity of a particle moving along a straight line is inversely proportional to its position. The particle is initially 1 m from point O and is 2 m from point O after 1 second.

- Find an expression for the particle's position, x m, at time t seconds.
- Find an expression for the particle's velocity, v m/s, at time t seconds.

Solution

- The information can be written as

$$v = \frac{k}{x} \quad \text{for } k \in \mathbb{R}^+, \quad x(0) = 1 \quad \text{and} \quad x(1) = 2$$

This gives

$$\frac{dx}{dt} = \frac{k}{x}$$

$$\therefore \frac{dt}{dx} = \frac{x}{k}$$

$$\begin{aligned} \therefore t &= \int \frac{x}{k} dx \\ &= \frac{x^2}{2k} + c \end{aligned}$$

$$\text{Since } x(0) = 1: \quad 0 = \frac{1}{2k} + c \quad (1)$$

$$\text{Since } x(1) = 2: \quad 1 = \frac{4}{2k} + c \quad (2)$$

Subtracting (1) from (2) yields $1 = \frac{3}{2k}$ and therefore $k = \frac{3}{2}$.

Substituting in (1) yields $c = -\frac{1}{2k} = -\frac{1}{3}$.

$$\text{Now } t = \frac{x^2}{3} - \frac{1}{3}$$

$$x^2 = 3t + 1$$

$$\therefore x = \pm\sqrt{3t + 1}$$

But when $t = 0$, $x = 1$ and therefore

$$x = \sqrt{3t + 1}$$

b $x = \sqrt{3t + 1}$ implies

$$\begin{aligned} v &= \frac{dx}{dt} = 3 \times \frac{1}{2} \times \frac{1}{\sqrt{3t + 1}} \\ &= \frac{3}{2\sqrt{3t + 1}} \end{aligned}$$

Example 18

A body moving in a straight line has an initial velocity of 25 m/s and its acceleration, a m/s², is given by $a = -k(50 - v)$, where k is a positive constant and v m/s is its velocity. Find v in terms of t and sketch the velocity–time graph for the motion.

(The motion stops when the body is instantaneously at rest for the first time.)

Solution

$$a = -k(50 - v)$$

$$\frac{dv}{dt} = -k(50 - v)$$

$$\frac{dt}{dv} = \frac{1}{-k(50 - v)}$$

$$\begin{aligned} t &= -\frac{1}{k} \int \frac{1}{50 - v} dv \\ &= -\frac{1}{k} (-\ln |50 - v|) + c \end{aligned}$$

$$\therefore t = \frac{1}{k} \ln(50 - v) + c \quad (\text{Note that } v \leq 25 \text{ since } a < 0.)$$

When $t = 0$, $v = 25$, and so $c = -\frac{1}{k} \ln 25$.

$$\text{Thus } t = \frac{1}{k} \ln\left(\frac{50 - v}{25}\right)$$

$$e^{kt} = \frac{50 - v}{25}$$

$$\therefore v = 50 - 25e^{kt}$$

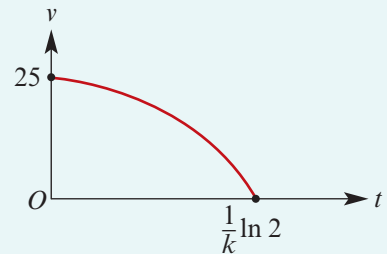

Example 19

The acceleration, a , of an object moving along a line is given by $a = -(v + 1)^2$, where v is the velocity of the object at time t . Also $v(0) = 10$ and $x(0) = 0$, where x is the position of the object at time t . Find:

- an expression for the velocity of the object in terms of t
- an expression for the position of the object in terms of t .

Solution

a $a = -(v + 1)^2$ gives

$$\frac{dv}{dt} = -(v + 1)^2$$

$$\frac{dt}{dv} = \frac{-1}{(v + 1)^2}$$

$$t = - \int \frac{1}{(v + 1)^2} dv$$

$$\therefore t = \frac{1}{v + 1} + c$$

Since $v(0) = 10$, we obtain $c = -\frac{1}{11}$ and so

$$t = \frac{1}{v + 1} - \frac{1}{11}$$

This can be rearranged as

$$v = \frac{11}{11t + 1} - 1$$

b $\frac{dx}{dt} = v = \frac{11}{11t + 1} - 1$

$$\therefore x = \int \frac{11}{11t + 1} - 1 dt$$

$$= \ln|11t + 1| - t + c$$

Since $x(0) = 0$, $c = 0$ and therefore $x = \ln|11t + 1| - t$.

Exercise 14D**Example 17**

1 A particle moves in a line such that the velocity, \dot{x} m/s, is given by $\dot{x} = \frac{1}{2x - 4}$, $x > 2$.

If $x = 3$ when $t = 0$, find:

- a** the position at 24 seconds
- b** the distance travelled in the first 24 seconds.

2 A particle moves in a straight line such that its velocity, v m/s, and position, x m, are related by $v = 1 + e^{-2x}$.

- a** Find x in terms of time t seconds ($t \geq 0$), given that $x = 0$ when $t = 0$.
- b** Hence find the acceleration when $t = \ln 5$.

Example 18

3 An object moves in a straight line such that its acceleration, a m/s², and velocity, v m/s, are related by $a = 3 + v$. If the object is initially at rest at the origin, find:

- a** v in term of t
- b** a in terms of t
- c** x in terms of t

- 4 An object falls from rest with acceleration, $a \text{ m/s}^2$, given by $a = g - kv$, $k > 0$. Find:
- an expression for the velocity, $v \text{ m/s}$, at time t seconds
 - the terminal velocity, i.e. the limiting velocity as $t \rightarrow \infty$.

Example 19

- 5 A body is projected along a horizontal surface. Its deceleration is $0.3(v^2 + 1)$, where $v \text{ m/s}$ is the velocity of the body at time t seconds. If the initial velocity is $\sqrt{3} \text{ m/s}$, find:
- an expression for v in terms of t
 - an expression for $x \text{ m}$, the displacement of the body from its original position, in terms of t .
- 6 The velocity, $v \text{ m/s}$, and acceleration, $a \text{ m/s}^2$, of an object t seconds after it is dropped from rest are related by $a = \frac{450 - v}{50}$ for $v < 450$. Express v in terms of t .
- 7 The brakes are applied in a car travelling in a straight line. The acceleration, $a \text{ m/s}^2$, of the car is given by $a = -0.4\sqrt{225 - v^2}$. If the initial velocity of the car was 12 m/s , find an expression for v , the velocity of the car, in terms of t , the time after the brakes were first applied.
- 8 An object moves in a straight line such that its velocity is directly proportional to $x \text{ m}$, its position relative to a fixed point O on the line. The object starts 5 m to the right of O with a velocity of 2 m/s .
- Express x in terms of t , where t is the time after the motion starts.
 - Find the position of the object after 10 seconds.
- 9 The velocity, $v \text{ m/s}$, and the acceleration, $a \text{ m/s}^2$, of an object t seconds after it is dropped from rest are related by the equation $a = \frac{1}{50}(500 - v)$, $0 \leq v < 500$.
- Express t in terms of v .
 - Express v in terms of t .
- 10 A particle is travelling in a horizontal straight line. The initial velocity of the particle is u and the acceleration is given by $-k(2u - v)$, where v is the velocity of the particle at any instant and k is a positive constant. Find the time taken for the particle to come to rest.
- 11 A boat is moving at 8 m/s . When the boat's engine stops, its acceleration is given by $\frac{dv}{dt} = -\frac{1}{5}v$. Express v in terms of t and find the velocity when $t = 4$.
- 12 A particle, initially at a point O , slows down under the influence of an acceleration, $a \text{ m/s}^2$, such that $a = -kv^2$, where $v \text{ m/s}$ is the velocity of the particle at any instant. Its initial velocity is 30 m/s and its initial acceleration is -20 m/s^2 . Find:
- its velocity at time t seconds
 - its position relative to the point O when $t = 10$.



14E Other expressions for acceleration

In the earlier sections of this chapter, we have written acceleration as $\frac{dv}{dt}$ and $\frac{d^2x}{dt^2}$. In this section, we use two further expressions for acceleration.

Expressions for acceleration

$$a = v \frac{dv}{dx} \quad \text{and} \quad a = \frac{d}{dx} \left(\frac{1}{2} v^2 \right)$$

Proof Using the chain rule:

$$a = \frac{dv}{dt} = \frac{dv}{dx} \frac{dx}{dt} = \frac{dv}{dx} v$$

Using the chain rule again:

$$\frac{d}{dx} \left(\frac{1}{2} v^2 \right) = \frac{d}{dv} \left(\frac{1}{2} v^2 \right) \frac{dv}{dx} = v \frac{dv}{dx} = a$$

The different expressions for acceleration are useful in different situations:

Given	Initial conditions	Useful form
$a = f(t)$	in terms of t and v	$a = \frac{dv}{dt}$
$a = f(v)$	in terms of t and v	$a = \frac{dv}{dt}$
$a = f(v)$	in terms of x and v	$a = v \frac{dv}{dx}$
$a = f(x)$	in terms of x and v	$a = \frac{d}{dx} \left(\frac{1}{2} v^2 \right)$

Note: In the last case, it is also possible to use $a = v \frac{dv}{dx}$ and separation of variables.

Example 20

An object travels in a line such that the velocity, v m/s, is given by $v^2 = 4 - x^2$. Find the acceleration at $x = 1$.

Solution

Given $v^2 = 4 - x^2$, we can use implicit differentiation to obtain:

$$\frac{d}{dx}(v^2) = \frac{d}{dx}(4 - x^2)$$

$$2v \frac{dv}{dx} = -2x$$

$$\therefore a = -x$$

So, at $x = 1$, $a = -1$. The acceleration at $x = 1$ is -1 m/s^2 .

Example 21

An object moves in a line so that the acceleration, \ddot{x} m/s², is given by $\ddot{x} = 1 + v$. Its velocity at the origin is 1 m/s. Find the position of the object when its velocity is 2 m/s.

Solution

Since we are given a as a function of v and initial conditions involving x and v , it is appropriate to use the form $a = v \frac{dv}{dx}$.

$$\text{Now } \ddot{x} = 1 + v$$

$$v \frac{dv}{dx} = 1 + v$$

$$\frac{dv}{dx} = \frac{1 + v}{v}$$

$$\frac{dx}{dv} = \frac{v}{1 + v}$$

$$\begin{aligned} \therefore x &= \int \frac{v}{1 + v} dv \\ &= \int 1 - \frac{1}{1 + v} dv \end{aligned}$$

$$\therefore x = v - \ln|1 + v| + c$$

Since $v = 1$ when $x = 0$, we have

$$0 = 1 - \ln 2 + c$$

$$\therefore c = \ln 2 - 1$$

$$\text{Hence } x = v - \ln|1 + v| + \ln 2 - 1$$

$$= v + \ln\left(\frac{2}{1 + v}\right) - 1 \quad (\text{as } v > 0)$$

Now, when $v = 2$,

$$\begin{aligned} x &= 2 + \ln\left(\frac{2}{3}\right) - 1 \\ &= 1 + \ln\left(\frac{2}{3}\right) \\ &\approx 0.59 \end{aligned}$$

So, when the velocity is 2 m/s, the position is 0.59 m.

Example 22

A particle is moving in a straight line. Its acceleration, a m/s², is described by $a = -\sqrt{x}$, where x m is its position with respect to an origin O . Find a relation between v and x which describes the motion, given that $v = 2$ m/s when the particle is at the origin.

Solution

Given $a = -\sqrt{x}$

$$\frac{d}{dx}\left(\frac{1}{2}v^2\right) = -x^{\frac{1}{2}}$$

$$\frac{1}{2}v^2 = -\frac{2}{3}x^{\frac{3}{2}} + c$$

When $x = 0$, $v = 2$, and therefore $c = 2$.

Thus $\frac{1}{2}v^2 = 2 - \frac{2}{3}x^{\frac{3}{2}}$

$$\therefore v^2 = \frac{4}{3}(3 - x^{\frac{3}{2}})$$

Note: This problem can also be solved using $a = v \frac{dv}{dx}$ and separation of variables.

**Example 23**

An object falls from a hovering helicopter over the ocean 1000 m above sea level. Find the velocity of the object when it hits the water:

- a** neglecting air resistance **b** assuming air resistance is $0.2v^2$.

Solution

- a** An appropriate starting point is $\ddot{y} = -9.8$.

Since the initial conditions involve y and v , use $\ddot{y} = \frac{d}{dy}\left(\frac{1}{2}v^2\right)$.

Now $\frac{d}{dy}\left(\frac{1}{2}v^2\right) = -9.8$

$$\frac{1}{2}v^2 = -9.8y + c$$

Using $v = 0$ at $y = 1000$ gives

$$0 = -9.8 \times 1000 + c$$

$$\therefore c = 9800$$

Hence $\frac{1}{2}v^2 = -9.8y + 9800$

$$\therefore v^2 = -19.6y + 19\,600$$

The object is falling, so $v < 0$.

$$v = -\sqrt{19\,600 - 19.6y}$$

At sea level, $y = 0$ and therefore

$$v = -\sqrt{19\,600} = -140$$

The object has a velocity of -140 m/s at sea level (504 km/h).

b In this case, we have

$$\begin{aligned}\ddot{y} &= -9.8 + 0.2v^2 \\ &= \frac{v^2 - 49}{5}\end{aligned}$$

Because of the initial conditions given, use $\ddot{y} = v \frac{dv}{dy}$:

$$\begin{aligned}v \frac{dv}{dy} &= \frac{v^2 - 49}{5} \\ \frac{dv}{dy} &= \frac{v^2 - 49}{5v} \\ y &= \int \frac{5v}{v^2 - 49} dv \\ &= \frac{5}{2} \int \frac{2v}{v^2 - 49} dv\end{aligned}$$

$$\therefore y = \frac{5}{2} \ln |v^2 - 49| + c$$

Now, when $v = 0$, $y = 1000$, and so $c = 1000 - \frac{5}{2} \ln 49$.

$$\begin{aligned}\therefore y &= \frac{5}{2} \ln |49 - v^2| + 1000 - \frac{5}{2} \ln 49 \\ &= \frac{5}{2} (\ln |49 - v^2| - \ln 49) + 1000 \\ &= \frac{5}{2} \ln \left| \frac{49 - v^2}{49} \right| + 1000\end{aligned}$$

Assume that $-7 < v < 7$. Then

$$\begin{aligned}y - 1000 &= \frac{5}{2} \ln \left(1 - \frac{v^2}{49} \right) \\ \frac{2}{5}(y - 1000) &= \ln \left(1 - \frac{v^2}{49} \right) \\ e^{\frac{2}{5}(y-1000)} &= 1 - \frac{v^2}{49}\end{aligned}$$

$$\therefore v^2 = 49 \left(1 - e^{\frac{2}{5}(y-1000)} \right)$$

But the object is falling and thus $v < 0$. Therefore

$$v = -7 \sqrt{1 - e^{\frac{2}{5}(y-1000)}}$$

At sea level, $y = 0$ and therefore

$$v = -7 \sqrt{1 - e^{-400}}$$

The object has a velocity of approximately -7 m/s at sea level (25.2 km/h).

Note: If $v < -7$, then $v^2 = 49 \left(1 + e^{\frac{2}{5}(y-1000)} \right)$ and the initial conditions are not satisfied.

Exercise 14E

Skillsheet

- 1** An object travels in a line such that the velocity, v m/s, is given by $v^2 = 9 - x^2$. Find the acceleration at $x = 2$.

Example 20

Example 21, 22

- 2** For each of the following, a particle moves in a horizontal line such that, at time t seconds, the position is x m, the velocity is v m/s and the acceleration is a m/s².
- a** If $a = -x$ and $v = 0$ at $x = 4$, find v at $x = 0$.
b If $a = 2 - v$ and $v = 0$ when $t = 0$, find t when $v = -2$.
c If $a = 2 - v$ and $v = 0$ when $x = 0$, find x when $v = -2$.
- 3** The motion of a particle is in a horizontal line such that, at time t seconds, the position is x m, the velocity is v m/s and the acceleration is a m/s².
- a** If $a = -v^3$ and $v = 1$ when $x = 0$, find v in terms of x .
b If $v = x + 1$ and $x = 0$ when $t = 0$, find:
 i x in terms of t **ii** a in terms of t **iii** a in terms of v .
- 4** An object is projected vertically upwards from the ground with an initial velocity of 100 m/s. Assuming that the acceleration, a m/s², is given by $a = -g - 0.2v^2$, find x in terms of v . Hence find the maximum height reached.
- 5** The velocity, v m/s, of a particle moving along a line is given by $v = 2\sqrt{1 - x^2}$. Find:
a the position, x m, in terms of time t seconds, given that when $t = 0$, $x = 1$
b the acceleration, a m/s², in terms of x .
- 6** Each of the following gives the acceleration, a m/s², of an object travelling in a line. Given that $v = 0$ and $x = 0$ when $t = 0$, solve for v in each case.
a $a = \frac{1}{1+t}$ **b** $a = \frac{1}{1+x}$, $x > -1$ **c** $a = \frac{1}{1+v}$
- 7** A particle moves in a straight line from a position of rest at a fixed origin O . Its velocity is v when its displacement from O is x . If its acceleration is $(2 + x)^{-2}$, find v in terms of x .
- 8** A particle moves in a straight line and, at time t , its position relative to a fixed origin is x and its velocity is v .
a If its acceleration is $1 + 2x$ and $v = 2$ when $x = 0$, find v when $x = 2$.
b If its acceleration is $2 - v$ and $v = 0$ when $x = 0$, find the position at which $v = 1$.
- Example 23
- 9** A particle is projected vertically upwards. The speed of projection is 50 m/s. The acceleration of the particle, a m/s², is given by $a = -\frac{1}{5}(v^2 + 50)$, where v m/s is the velocity of the particle when it is x m above the point of projection. Find:
a the height reached by the particle
b the time taken to reach this highest point.



14F Simple harmonic motion

Simple harmonic motion occurs when a particle is moving along a straight line such that its acceleration is always directed towards a fixed point O on the line and directly proportional to its distance from O . The particle will oscillate about O between two points P and Q .

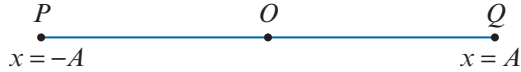

Situations that can be modelled using simple harmonic motion include the oscillation of a spring, the motion of a simple pendulum and molecular vibration.

Equations of simple harmonic motion

For a particle in simple harmonic motion about the origin O , let x be its position with respect to O at time t . The particle's motion is described by the following equations, where A , n and ϵ are constants with $A > 0$ and $n > 0$:

Acceleration	$\ddot{x} = -n^2x$
Velocity	$v^2 = n^2(A^2 - x^2)$
Position	$x = A \sin(nt + \epsilon)$

We can easily verify that the position function $x = A \sin(nt + \epsilon)$ is a solution of the differential equation $\ddot{x} = -n^2x$, since we obtain

$$\begin{aligned} \dot{x} &= nA \cos(nt + \epsilon) \\ \therefore \ddot{x} &= -n^2A \sin(nt + \epsilon) = -n^2x \end{aligned}$$

It is more difficult to show that it is the general solution, but we can give an indication as to why this is the case. Starting from $\ddot{x} = -n^2x$, we can write

$$\begin{aligned} \frac{d}{dx} \left(\frac{1}{2} v^2 \right) &= -n^2x \\ \therefore \frac{1}{2} v^2 &= -\frac{1}{2} n^2 x^2 + c \end{aligned}$$

The particle will be at rest when $x = A$ or $x = -A$. So $c = \frac{1}{2} n^2 A^2$ and we have

$$\begin{aligned} v^2 &= n^2(A^2 - x^2) \\ \therefore v &= \pm n \sqrt{A^2 - x^2} \end{aligned}$$

For simplicity, we only consider the case where $v > 0$. Then we have

$$\begin{aligned} \frac{dx}{dt} &= n \sqrt{A^2 - x^2} \\ \frac{dt}{dx} &= \frac{1}{n \sqrt{A^2 - x^2}} \\ \therefore t &= \frac{1}{n} \arcsin \left(\frac{x}{A} \right) + d \end{aligned}$$

This gives $x = A \sin(nt + \epsilon)$, where $\epsilon = -nd$.

► Properties of simple harmonic motion

Consider a particle in simple harmonic motion, with its position x at time t given by $x = A \sin(nt + \varepsilon)$, where $A > 0$ and $n > 0$.

Amplitude	A	the particle's maximum distance from the centre of motion
Period	$T = \frac{2\pi}{n}$	the time taken for one complete cycle
Frequency	$f = \frac{1}{T} = \frac{n}{2\pi}$	the number of cycles per unit of time

- The phase constant ε depends on the initial position of the particle. If $x = 0$ when $t = 0$, then we can take $\varepsilon = 0$.
- Since $\dot{x} = nA \cos(nt + \varepsilon)$, the maximum speed of the particle is nA .
- Since $\ddot{x} = -n^2A \sin(nt + \varepsilon)$, the maximum magnitude of the acceleration is n^2A .

	P	O	Q
	•	•	•

	At point P	At point O	At point Q
Position	$x = -A$	$x = 0$	$x = A$
Velocity	$\dot{x} = 0$	$\dot{x} = \pm nA$	$\dot{x} = 0$
Acceleration	$\ddot{x} = n^2A$	$\ddot{x} = 0$	$\ddot{x} = -n^2A$

Note: From the velocity equation $v^2 = n^2(A^2 - x^2)$, we can see that the speed of the particle is determined by its position. But its velocity is not determined by its position (except at the endpoints), as the particle may be travelling in either direction.

Example 24

A particle is moving in a straight line with simple harmonic motion. Relative to an origin O , its position, x cm, at time t seconds is given by

$$x = 4 \sin\left(\frac{2\pi t}{3}\right)$$

Find:

- | | |
|---|--|
| <p>a the particle's velocity at time t</p> <p>c the period of the motion</p> | <p>b the particle's acceleration at time t</p> <p>d the particle's maximum speed.</p> |
|---|--|

Solution

a $v = \frac{dx}{dt} = \frac{8\pi}{3} \cos\left(\frac{2\pi t}{3}\right)$

b $a = \frac{dv}{dt} = -\frac{16\pi^2}{9} \sin\left(\frac{2\pi t}{3}\right)$

c $T = \frac{2\pi}{n} = 2\pi \times \frac{3}{2\pi} = 3$

The period is 3 seconds.

d The maximum value of $|v|$ is $\frac{8\pi}{3}$.

So the maximum speed is $\frac{8\pi}{3}$ cm/s.

Example 25

A particle moves in a straight line with acceleration given by $\ddot{x} = -9x$, where x is the position of the particle at time t . The particle's initial position and velocity are $x(0) = 0$ and $\dot{x}(0) = 4$. Find:

- a** the period and amplitude of the motion
- b** the particle's position, velocity and acceleration at time t .

Solution

a In this case, we have $n^2 = 9$.

So $n = 3$ and the period is

$$T = \frac{2\pi}{n} = \frac{2\pi}{3}$$

To find the amplitude, we use

$$v^2 = n^2(A^2 - x^2)$$

Since $v(0) = 4$ and $x(0) = 0$:

$$16 = 9(A^2 - 0)$$

$$\frac{16}{9} = A^2$$

The amplitude is $A = \frac{4}{3}$.

b We know that

$$\begin{aligned} x &= A \sin(nt + \varepsilon) \\ &= \frac{4}{3} \sin(3t + \varepsilon) \end{aligned}$$

Since $x(0) = 0$, we can take $\varepsilon = 0$. So

$$x = \frac{4}{3} \sin(3t)$$

$$\therefore \dot{x} = 4 \cos(3t)$$

$$\therefore \ddot{x} = -12 \sin(3t)$$

► Simple harmonic motion about a point other than the origin

If the centre of motion is at $x = c$, then the equations of simple harmonic motion are:

$$\ddot{x} = -n^2(x - c)$$

$$v^2 = n^2(A^2 - (x - c)^2)$$

$$x = c + A \sin(nt + \varepsilon)$$

Example 26

If $v^2 = -(x^2 - 6bx + 5b^2)$, prove that the motion is simple harmonic and find the period, amplitude and maximum speed.

Solution

$$\frac{1}{2}v^2 = -\frac{1}{2}(x^2 - 6bx + 5b^2)$$

$$\frac{d}{dx}\left(\frac{1}{2}v^2\right) = \frac{d}{dx}\left(-\frac{1}{2}(x^2 - 6bx + 5b^2)\right)$$

$$\ddot{x} = -\frac{1}{2}(2x - 6b)$$

$$\therefore \ddot{x} = -(x - 3b)$$

The motion is simple harmonic with $n^2 = 1$ and $c = 3b$. The period is 2π .

When $v = 0$:

$$x^2 - 6bx + 5b^2 = 0$$

$$(x - 5b)(x - b) = 0$$

$$\therefore x = 5b \text{ or } x = b$$

The motion takes place between $x = b$ and $x = 5b$. The centre of motion is at $x = 3b$.

Therefore the amplitude is $A = 2b$ and the maximum speed is $nA = 2b$.

Exercise 14F

Example 24

- 1** A particle is moving in a straight line such that its position, x metres, at time t seconds is given by $x = 0.5 \sin(2\pi t)$. Find:
- a** the amplitude of the motion
 - b** the period of oscillation
 - c** the maximum speed
 - d** the maximum acceleration.

Example 25

- 2** A particle moves in a straight line with acceleration given by $\ddot{x} = -25x$, where x is the position of the particle at time t . The particle's initial position and velocity are $x(0) = 4$ and $\dot{x}(0) = 0$. Find:
- a** the period and amplitude of the motion
 - b** the particle's position, velocity and acceleration at time t .
- 3** A body is oscillating in simple harmonic motion with a frequency of 15 cycles per second. The maximum acceleration of the body is 20 m/s^2 . Find:
- a** the maximum speed
 - b** the amplitude of the motion
 - c** the average speed for one oscillation.
- 4** A body is oscillating in simple harmonic motion with an amplitude of 1.7 m. After travelling 0.1 m from a position of rest, the body has a speed of 2 m/s. How much further does the body travel before its speed first reaches 4 m/s? What is the greatest speed that it achieves?
- 5** A particle moves in a straight line with acceleration given by $\ddot{x} = -n^2x$, where x is its position relative to the origin O . The particle is initially moving towards O . When it is 4 m from O , its speed is 20 m/s and the magnitude of its acceleration is $\frac{20}{3} \text{ m/s}^2$. At what distance from O did it start from rest?
- 6** An object moves in simple harmonic motion with amplitude 2 m and period π seconds. Give an expression to describe the position of the object, x m, relative to the origin at time t seconds from the beginning of motion.

- 7** A particle is moving with simple harmonic motion such that its position, x metres, at time t seconds is given by $x = 0.2 \cos(4\pi t)$. Calculate:
- a** the amplitude of the motion **b** the period of the motion.
- 8** A particle moving in simple harmonic motion completes 120 oscillations per minute. Its greatest speed is 5 cm/s. Find the maximum magnitude of the acceleration.
- 9** A particle is moving in simple harmonic motion with a period of $\frac{\pi}{12}$ s and an amplitude of 5 cm. Find the speed of the particle when it is 3 cm from the centre of its motion.
- 10** A particle is moving along a straight line. Relative to an origin O , its position, x cm, at time t seconds is given by $x = 2 \sin\left(\frac{\pi t}{6}\right)$. Find:
- a** the amplitude of the motion
b the period of the motion
c the maximum speed of the particle
d the maximum magnitude of the acceleration.
- 11** A ride on a ferris wheel lasts for 5 minutes. The height, h m, of a particular passenger's foot above the centre is given by $h = 15 \sin(10t)^\circ$ at time t seconds from the beginning of the ride. On how many occasions is the passenger's foot 10 metres above the centre during the first minute of the ride? Find the corresponding values of t .
- 12** A particle moving in a straight line has acceleration given by $\ddot{x} = -9x$, where x m is the position of the particle at time t seconds. If $x = 5$ and $v = 0$ when $t = 0$, find:
- a** the period of the motion **b** the maximum speed
c the velocity at time t **d** the position at time t .
- 13** A body moving in simple harmonic motion has position, x cm, at time t seconds given by $x = 10 \cos\left(\frac{\pi t}{12}\right)$. Find:
- a** the velocity at time t **b** the acceleration at time t
c the period of the motion **d** the maximum speed
e the maximum magnitude of the acceleration.
- 14** A particle in simple harmonic motion has position, x cm, at time t seconds given by

$$x = 8 \sin\left(\frac{\pi t}{5}\right) \quad \text{for } 0 \leq t \leq 7$$

Find the values of t when:

- a i** $x = 8$ **ii** $x = 0$ **iii** $x = -8$ **iv** $x = 4$
b $|\dot{x}|$ is a maximum
c i $\dot{x} = \frac{4\pi}{5}$ **ii** $\dot{x} = -\frac{4\pi}{5}$

15 Given that $\ddot{x} = -9x$, find x as a function of t for each of the following cases:

- a** $x = 5$ and $\dot{x} = 0$ when $t = 0$
- b** $x = 0$ and $\dot{x} = 10$ when $t = 0$
- c** $x = 5$ and $\dot{x} = 5$ when $t = 0$.

Example 26

16 For a particle moving in a straight line, the velocity v satisfies $v^2 = 36 - 6x - 2x^2$, where x is the position of the particle relative to a fixed point O .

- a** Show that the motion is simple harmonic motion.
- b**
 - i** Find the period.
 - ii** Find the amplitude.
 - iii** Find the maximum speed.

17 A particle is moving in a straight line. At time t seconds, its position, x cm, relative to a fixed point O is given by

$$x = 5 \cos\left(\frac{\pi}{4}t + \frac{\pi}{3}\right)$$

- a** Find the velocity and acceleration in terms of t .
- b** Find the velocity and acceleration in terms of x .
- c** Find:
 - i** the period of the motion
 - ii** the amplitude of the motion
 - iii** the speed when $x = -\frac{5}{2}$
 - iv** the acceleration when $t = 0$.

18 The position at time t of a particle moving in a straight line is given by $x = 5 - 4 \cos^2 t$.

- a** Show that the motion is simple harmonic motion.
- b**
 - i** Find the centre of motion.
 - ii** Find the amplitude.
 - iii** Find the period.

19 A particle is moving in simple harmonic motion with $\ddot{x} = -9x + 9$.

- a** Find x at time t , given that $x = 0$ and $\dot{x} = 3$ when $t = 0$.
- b** Find the period and amplitude of the motion.

20 For a particle moving in a straight line, the velocity v satisfies $v^2 = 96 + 64x - 32x^2$, where x is the position of the particle relative to a fixed point O .

- a** Show that the motion is simple harmonic motion.
- b**
 - i** Find the centre of motion.
 - ii** Find the amplitude.
 - iii** Find the period.



Chapter summary



- The **position** of a particle moving in a straight line is determined by its distance from a fixed point O on the line, called the origin, and whether it is to the right or left of O . By convention, the direction to the right of the origin is considered to be positive.

- **Displacement** is the change in position (i.e. final position minus initial position).

- **Average velocity** = $\frac{\text{change in position}}{\text{change in time}}$

- For a particle moving in a straight line with position x at time t :

- **velocity** (v) is the rate of change of position with respect to time
- **acceleration** (a) is the rate of change of velocity with respect to time

$$v = \frac{dx}{dt}, \quad a = \frac{dv}{dt} = \frac{d^2x}{dt^2}$$

- velocity at time t is also denoted by $\dot{x}(t)$
- acceleration at time t is also denoted by $\ddot{x}(t)$

- **Scalar quantities**

- **Distance travelled** means the total distance travelled.
- **Speed** is the magnitude of the velocity.

- **Average speed** = $\frac{\text{distance travelled}}{\text{change in time}}$

- **Constant acceleration**

If acceleration is constant, then the following formulas can be used (for acceleration a , initial velocity u , final velocity v , displacement s and time taken t):

$$1 \quad v = u + at \qquad 2 \quad s = ut + \frac{1}{2}at^2 \qquad 3 \quad v^2 = u^2 + 2as \qquad 4 \quad s = \frac{1}{2}(u + v)t$$

- **Velocity–time graphs**

- Acceleration is given by the gradient.
- Displacement is given by the signed area bounded by the graph and the t -axis.
- Distance travelled is given by the total area bounded by the graph and the t -axis.

- **Acceleration** $\frac{d^2x}{dt^2} = \frac{dv}{dt} = v \frac{dv}{dx} = \frac{d}{dx} \left(\frac{1}{2}v^2 \right)$

- **Simple harmonic motion**

Simple harmonic motion is a special type of motion in a straight line where the particle is oscillating about a centre point.

- Centred at the origin:

$$\ddot{x} = -n^2x$$

$$v^2 = n^2(A^2 - x^2)$$

$$x = A \sin(nt + \varepsilon)$$

- Centred at $x = c$:

$$\ddot{x} = -n^2(x - c)$$

$$v^2 = n^2(A^2 - (x - c)^2)$$

$$x = c + A \sin(nt + \varepsilon)$$

- Amplitude A
- Period $T = \frac{2\pi}{n}$
- Frequency $f = \frac{1}{T} = \frac{n}{2\pi}$

Short-answer questions

- 1 A particle is moving in a straight line with position, x metres, at time t seconds ($t \geq 0$) given by $x = t^2 - 7t + 10$. Find:
 - a when its velocity equals zero
 - b its acceleration at this time
 - c the distance travelled in the first 5 seconds
 - d when and where its velocity is -2 m/s.

- 2 An object moves in a straight line so that its acceleration, a m/s², at time t seconds ($t \geq 0$) is given by $a = 2t - 3$. Initially, the position of the object is 2 m to the right of a point O and its velocity is 3 m/s. Find the position and velocity after 10 seconds.

- 3 Two tram stops are 800 m apart. A tram starts at rest from the first stop and accelerates at a constant rate of a m/s² for a certain time and then decelerates at a constant rate of $2a$ m/s², before coming to rest at the second stop. The time taken to travel between the stops is 1 minute 40 seconds. Find:
 - a the maximum speed reached by the tram in km/h
 - b the time at which the brakes are applied
 - c the value of a .

- 4 The velocity–time graph shows the journey of a bullet fired into the wall of a practice range made up of three successive layers of soil, wood and brick.

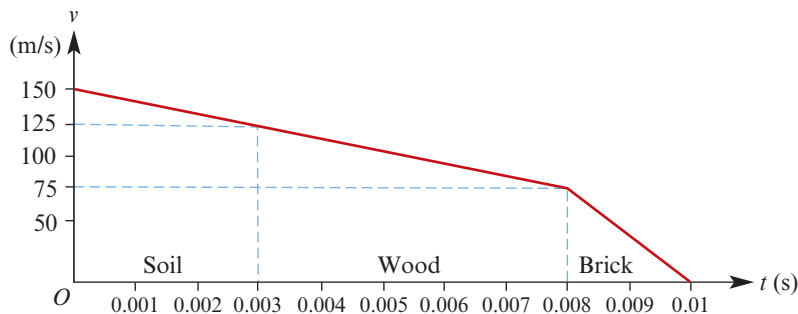

Calculate:

- a the deceleration of the bullet as it passes through the soil
- b the thickness of the layer of soil
- c the deceleration of the bullet as it passes through the wood
- d the thickness of the layer of wood
- e the deceleration of the bullet passing through the brick
- f the depth penetrated by the bullet into the layer of brick.

- 5** A helicopter climbs vertically from the top of a 110-metre tall building, so that its height in metres above the ground after t seconds is given by $h = 110 + 55t - 5.5t^2$. Calculate:
- the average velocity of the helicopter from $t = 0$ to $t = 2$
 - its instantaneous velocity at time t
 - its instantaneous velocity at time $t = 1$
 - the time at which the helicopter's velocity is zero
 - the maximum height reached above the ground.
- 6** A golf ball is putted across a level putting green with an initial velocity of 8 m/s. Owing to friction, the velocity decreases at the rate of 2 m/s^2 . How far will the golf ball roll?
- 7** A particle moves in a straight line such that after t seconds its position, x metres, relative to a point O on the line is given by $x = \sqrt{9 - t^2}$, $0 \leq t < 3$.
- When is the position $\sqrt{5}$?
 - Find expressions for the velocity and acceleration of the particle at time t .
 - Find the particle's maximum distance from O .
 - When is the velocity zero?
- 8** A particle moving in a straight line passes through a fixed point O with velocity 8 m/s. Its acceleration, $a \text{ m/s}^2$, at time t seconds after passing O is given by $a = 12 - 6t$. Find:
- the velocity of the particle when $t = 2$
 - the displacement of the particle from O when $t = 2$.
- 9** A particle travels at 12 m/s for 5 seconds. It then accelerates uniformly for the next 8 seconds to a velocity of x m/s, and then decelerates uniformly to rest during the next 3 seconds. Sketch a velocity–time graph. Given that the total distance travelled is 218 m, calculate:
- the value of x
 - the average velocity.
- 10** A ball is thrown vertically upwards from ground level with an initial velocity of 35 m/s. Let $g \text{ m/s}^2$ be the acceleration due to gravity. Find:
- the velocity, in terms of g , and the direction of motion of the ball after:
 - 3 seconds
 - 5 seconds
 - the total distance travelled by the ball, in terms of g , when it reaches the ground again
 - the velocity with which the ball strikes the ground.
- 11** A car is uniformly accelerated from rest at a set of traffic lights until it reaches a speed of 10 m/s in 5 seconds. It then continues to move at the same constant speed of 10 m/s for 6 seconds before the car's brakes uniformly retard it at 5 m/s^2 until it comes to rest at a second set of traffic lights. Draw a velocity–time graph of the car's journey and calculate the distance between the two sets of traffic lights.

- 12** A missile is fired vertically upwards from a point on the ground, level with the base of a tower 64 m high. The missile is level with the top of the tower 0.8 seconds after being fired. Let $g \text{ m/s}^2$ be the acceleration due to gravity. Find in terms of g :
- the initial velocity of the missile
 - the time taken to reach its greatest height
 - the greatest height
 - the length of time for which the missile is higher than the top of the tower.
- 13** For a particle moving in a straight line, the velocity v satisfies $v^2 = 128 - 32x - 16x^2$, where x is the position of the particle relative to a fixed point O .
- Show that the motion is simple harmonic motion.
 - i** Find the period. **ii** Find the amplitude. **iii** Find the maximum speed.



Multiple-choice questions



- 1** A particle moves in a straight line so that its position, x cm, relative to a point O at time t seconds ($t \geq 0$) is given by $x = t^3 - 9t^2 + 24t - 1$. The position (in cm) of the particle at $t = 3$ is
- A** 17 **B** 16 **C** 24 **D** -17 **E** 8
- 2** A particle moves in a straight line so that its position, x cm, relative to a fixed point O at time t seconds ($t \geq 0$) is given by $x = t^3 - 9t^2 + 24t - 1$. The average speed (in cm/s) of the particle in the first 2 seconds is
- A** 0 **B** -12 **C** 10 **D** -10 **E** 9.5
- 3** A body is projected up from the ground with a velocity of 30 m/s. Its acceleration due to gravity is -10 m/s^2 . The body's velocity (in m/s) at time $t = 2$ seconds is
- A** 10 **B** -10 **C** 0 **D** 20 **E** -20
- 4** A car accelerating uniformly from rest reaches a speed of 50 km/h in 5 seconds. The car's acceleration during the 5 seconds is
- A** 10 km/s² **B** 10 m/s² **C** 2.78 m/s² **D** $\frac{25}{9} \text{ m/s}^2$ **E** $\frac{25}{3} \text{ m/s}^2$
- 5** A particle moves in a straight line such that, at time t ($t \geq 0$), its velocity v is given by $v = 5 - \frac{2}{t+2}$. The initial acceleration of the particle is
- A** 0 **B** $\frac{1}{2}$ **C** 1 **D** 2 **E** 4
- 6** An object is oscillating along a straight line with acceleration given by $\ddot{x} = -9x$, where x cm is the position of the particle relative to the centre of motion. The maximum speed is 6 cm/s. The period, T s, and amplitude, A cm, of the motion are given by
- A** $T = \frac{2\pi}{3}$, $A = 6$ **B** $T = 3$, $A = 6$ **C** $T = \frac{2\pi}{3}$, $A = 4$
- D** $T = 6\pi$, $A = 9$ **E** $T = \frac{2\pi}{3}$, $A = 2$

- 7 The velocity–time graph shown describes the motion of a particle. The time (in seconds) when the velocity of the particle is first zero is closest to

A 0 B 125
C 147 D 150
E 250

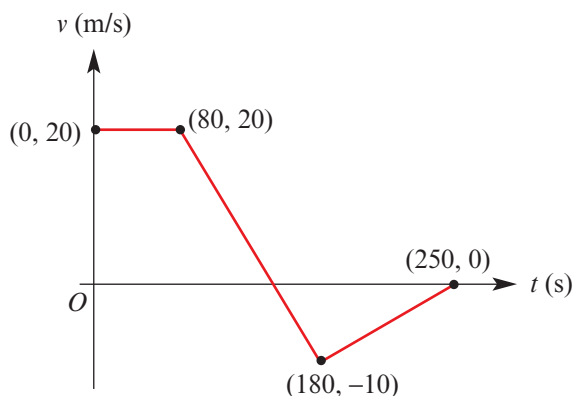

- 8 A particle is travelling in a straight line. Its position, x metres, relative to the origin is given by $x = 2t^3 - 10t^2 - 44t + 112$. In the interval $0 \leq t \leq 10$, the number of times that the particle passes through the origin is
- A 0 B 1 C 2 D 3 E 4
- 9 An object is moving in a straight line. Its acceleration, $a \text{ m/s}^2$, and its position relative to the origin, $x \text{ m}$, are related by $a = -x$, where $-\sqrt{3} \leq x \leq \sqrt{3}$. If the object starts from the origin with a velocity of $\sqrt{3} \text{ m/s}$, then its velocity, $v \text{ m/s}$, is given by
- A $-\sqrt{3-x^2}$ B $\sqrt{3-x^2}$ C $\pm\sqrt{3-x^2}$ D $-\sqrt{x^2-3}$ E $\sqrt{x^2-3}$
- 10 The position, x metres, with respect to an origin of a particle travelling in a straight line is given by $x = 2 - 2 \cos\left(\frac{3\pi}{2}t - \frac{\pi}{2}\right)$. The velocity (in m/s) at time $t = \frac{8}{3}$ seconds is
- A -3π B 3π C 0 D $-\frac{3\pi}{2}$ E $\frac{3\pi}{2}$
- 11 An object starting at the origin has a velocity given by $v = 10 \sin(\pi t)$. The distance that the object travels from $t = 0$ to $t = 1.6$, correct to two decimal places, is
- A 1.60 B 2.20 C 4.17 D 6.37 E 10.53



Extended-response questions

- 1 A stone initially at rest is released and falls vertically. Its velocity, $v \text{ m/s}$, at time t seconds satisfies $5 \frac{dv}{dt} + v = 50$.
- Find the acceleration of the stone when $t = 0$.
 - Find v in terms of t .
 - Sketch the graph of v against t .
 - Find the value of t for which $v = 47.5$ (correct to two decimal places).
 - Let $x \text{ m}$ be the distance fallen after t seconds.
 - Find x in terms of t .
 - Sketch the graph of x against t ($t \geq 0$).
 - How long does it take the stone to fall 8 metres (correct to two decimal places)?

- 2** A particle is moving along a straight line. At time t seconds after it passes a point O on the line, its velocity is v m/s, where $v = A - \ln(t + B)$ for positive constants A and B .

a If $A = 1$ and $B = 0.5$:

- i** Sketch the graph of v against t .
- ii** Find the position of the particle when $t = 3$ (correct to two decimal places).
- iii** Find the distance travelled by the particle in the 3 seconds after passing O (correct to two decimal places).

b If the acceleration of the particle is $-\frac{1}{20}$ m/s² when $t = 10$ and the particle comes to rest when $t = 100$, find the exact value of B and the value of A correct to two decimal places.

- 3** The velocity, v km/h, of a train which moves along a straight track from station A , where it starts at rest, to station B , where it next stops, is given by

$$v = kt(1 - \sin(\pi t))$$

where t hours is the time measured from when the train left station A and k is a positive constant.

- a** Find the time that the train takes to travel from A to B .
 - b**
 - i** Find an expression for the acceleration at time t .
 - ii** Find the interval of time for which the velocity is increasing. (Give your answer correct to two decimal places.)
 - c** Given that the distance from A to B is 20 km, find the value of k . (Give your answer correct to three significant figures.)
- 4** A particle A moves along a horizontal line so that its position, x m, relative to a point O is given by

$$x = 28 + 4t - 5t^2 - t^3$$

where t is the time in seconds after the motion starts.

a Find:

- i** the velocity of A in terms of t
- ii** the acceleration of A in terms of t
- iii** the value of t for which the velocity is zero (to two decimal places)
- iv** the times when the particle is 28 m to the right of O (to two decimal places)
- v** the time when the particle is 28 m to the left of O (to two decimal places).

b A second particle B moves along the same line as A . It starts from O at the same time that A begins to move. The initial velocity of B is 2 m/s and its acceleration at time t is $(2 - 6t)$ m/s².

- i** Find the position of B at time t .
- ii** Find the time at which A and B collide.
- iii** At the time of collision are they going in the same direction?

- 5** A particle moves in a straight line. At time t seconds its position, x cm, with respect to a fixed point O on the line is given by $x = 5 \cos\left(\frac{\pi}{4}t + \frac{\pi}{3}\right)$.
- a** Find:
- the velocity in terms of t
 - the acceleration in terms of t .
- b** Find:
- the velocity in terms of x
 - the acceleration in terms of x .
- c** Find the speed of the particle when $x = -2.5$, correct to one decimal place.
- d** Find the acceleration when $t = 0$, correct to two decimal places.
- e** Find:
- the maximum distance of the particle from O
 - the maximum speed of the particle
 - the maximum magnitude of acceleration of the particle.
- 6** In a tall building, two lifts simultaneously pass the 40th floor, each travelling downwards at 24 m/s. One lift immediately slows down with a constant retardation of $\frac{6}{7}$ m/s². The other continues for 6 seconds at 24 m/s and then slows down with a retardation of $\frac{1}{3}(t - 6)$ m/s², where t seconds is the time that has elapsed since passing the 40th floor. Find the difference between the heights of the lifts when both have come to rest.
- 7** The motion of a bullet through a special shield is modelled by the equation $a = -30(v + 110)^2$, $v \geq 0$, where a m/s² is its acceleration and v m/s its velocity t seconds after impact. When $t = 0$, $v = 300$.
- a** Find v in terms of t .
- b** Sketch the graph of v against t .
- c** Let x m be the penetration into the shield at time t seconds.
- Find x in terms of t
 - Find x in terms of v .
 - Find how far the bullet penetrates the shield before coming to rest.
- d** Another model for the bullet's motion is $a = -30(v^2 + 11\,000)$, $v \geq 0$. Given that when $t = 0$, $v = 300$:
- Find t in terms of v .
 - Find v in terms of t .
 - Sketch the graph of v against t .
 - Find the distance travelled by the bullet in the first 0.0001 seconds after impact.

- 8** A motorist is travelling at 25 m/s along a straight road and passes a stationary police officer on a motorcycle. Four seconds after the motorist passes, the police officer starts in pursuit. The police officer's motion for the first 6 seconds is described by

$$v(t) = \frac{-3}{10} \left(t^3 - 21t^2 + \frac{364}{3}t - \frac{1281}{6} \right), \quad 4 \leq t \leq 10$$

where $v(t)$ m/s is his speed t seconds after the motorist has passed. After 6 seconds, he reaches a speed of v_1 m/s, which he maintains until he overtakes the motorist.

- a** Find the value of v_1 .
- b** **i** Find $\frac{dv}{dt}$ for $4 \leq t \leq 10$.
ii Find the time when the police officer's acceleration is a maximum.
- c** On the same set of axes, sketch the velocity–time graphs for the motorist and the police officer.
- d** **i** How far has the police officer travelled when he reaches his maximum speed at $t = 10$?
ii Write down an expression for the distance travelled by the police officer for $t \in [4, 10]$.
- e** For what value of t does the police officer draw level with the motorist? (Give your answer correct to two decimal places.)
- 9** Two cyclists, A and B , pass a starting post together (but at different velocities) and race along a straight road. They are able to pass each other. At time t hours after they pass the post, their velocities (in km/h) are given by

$$V_A = \begin{cases} 9 - t^2 & \text{for } 0 \leq t \leq 3 \\ 2t - 6 & \text{for } t > 3 \end{cases} \quad \text{and} \quad V_B = 8, \quad \text{for } t \geq 0$$

- a** On the one set of axes, draw the velocity–time graphs for the two cyclists.
- b** Find the times at which the two cyclists have the same velocity.
- c** Find the time in hours, correct to one decimal place, when:
i A passes B **ii** B passes A .
- 10** Two particles, P and Q , move along the same straight path and can overtake each other. Their velocities are $V_P = 2 - t + \frac{1}{4}t^2$ and $V_Q = \frac{3}{4} + \frac{1}{2}t$ respectively at time t , for $t \geq 0$.
- a** **i** Find the times when the velocities of P and Q are the same.
ii On the same diagram, sketch velocity–time graphs to represent the motion of P and the motion of Q .
- b** If the particles start from the same point at time $t = 0$:
i Find the time when P and Q next meet again (correct to one decimal place).
ii State the times during which P is further than Q from the starting point (correct to one decimal place).

- 11** Annabelle and Cuthbert are ants on a picnic table. Annabelle falls off the edge of the table at point X . She falls 1.2 m to the ground. (Assume $g = 9.8$ for this question.)
- Assuming that Annabelle's acceleration down is $g \text{ m/s}^2$, find:
 - Annabelle's velocity when she hits the ground, correct to two decimal places
 - the time it takes for Annabelle to hit the ground, correct to two decimal places.
 - Assume now that Annabelle's acceleration is slowed by air resistance and is given by $(g - t) \text{ m/s}^2$, where t is the time in seconds after leaving the table.
 - Find Annabelle's velocity, $v \text{ m/s}$, at time t .
 - Find Annabelle's position, $x \text{ m}$, relative to X at time t .
 - Find the time in seconds, correct to two decimal places, when Annabelle hits the ground.
 - When Cuthbert reaches the edge of the table, he observes Annabelle groaning on the ground below. He decides that action must be taken and fashions a parachute from a small piece of potato chip. He jumps from the table and his acceleration is $\frac{g}{2} \text{ m/s}^2$ down.
 - Find an expression for x , the distance in metres that Cuthbert is from the ground at time t seconds.
 - Unfortunately, Annabelle is very dizzy and on seeing Cuthbert coming down jumps vertically with joy. Her initial velocity is 1.4 m/s up and her acceleration is $g \text{ m/s}^2$ down. She jumps 0.45 seconds after Cuthbert leaves the top of the table. How far above the ground (to the nearest cm) do the two ants collide?
- 12** On a straight road, a car starts from rest with an acceleration of 2 m/s^2 and travels until it reaches a velocity of 6 m/s. The car then travels with constant velocity for 10 seconds before the brakes cause a deceleration of $(v + 2) \text{ m/s}^2$ until it comes to rest, where $v \text{ m/s}$ is the velocity of the car.
- For how long is the car accelerating?
 - Find an expression for v , the velocity of the car, in terms of t , the time in seconds after it starts.
 - Find the total time taken for the motion of the car, to the nearest tenth of a second.
 - Draw a velocity–time graph of the motion.
 - Find the total distance travelled by the car to the nearest tenth of a metre.
- 13** A particle moves in a straight line such that its velocity at time $t \geq 0$ is given by
- $$v = \begin{cases} 3 - (t - 1)^2 & \text{for } 0 \leq t \leq 2 \\ 6 - 2t & \text{for } t > 2 \end{cases}$$
- Draw the velocity–time graph for $t \geq 0$.
 - Find the distance travelled by the particle from its initial position until it first comes to rest.
 - If the particle returns to its original position at $t = T$, calculate T correct to two decimal places.



15

Revision of Chapters 10–14

15A Short-answer questions

- 1** The graph of $y = 3 \arccos\left(\frac{x}{2}\right)$ is shown opposite.
- a** Find the area bounded by the graph, the x -axis and the line $x = -2$.
- b** Find the volume of the solid of revolution formed when the graph is rotated about the y -axis.

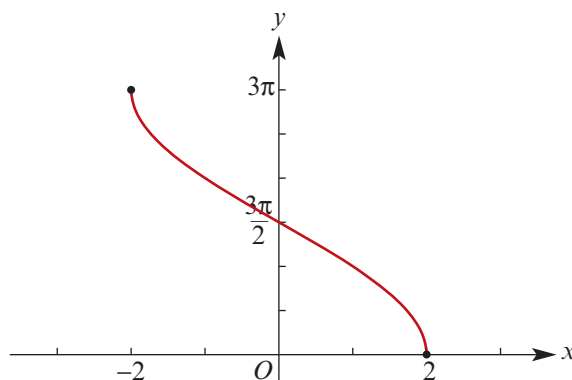

- 2** Consider the relation $5x^2 + 2xy + y^2 = 13$.
- a** Find the gradient of each of the tangents to the graph at the points where $x = 1$.
- b** Find the equation of the normal to the graph at the point in the first quadrant where $x = 1$.
- 3** Sketch the graph of $y = \frac{4 - x^3}{3x^2}$. Give the coordinates of any turning points and axis intercepts and state the equations of all asymptotes.
- 4** Let $f(x) = \frac{1 + x^2}{4 - x^2}$.
- a** Express $f(x)$ as partial fractions.
- b** Find the area enclosed by the graph of $y = f(x)$ and the lines $x = 1$ and $x = -1$.
- 5** Find y as a function of x given that $\frac{dy}{dx} = e^{2y} \sin(2x)$ and that $y = 0$ when $x = 0$.

- 6** Find the solution of the differential equation $(1 + x^2) \frac{dy}{dx} = 2xy$, given $y = 2$ when $x = 0$.
- 7** Let $f(x) = \arcsin(4x^2 - 3)$. Find the maximal domain of f .
- 8** Sketch the graph of $f(x) = \frac{4x^2 + 5}{x^2 + 1}$.
- 9** For the curve defined by the parametric equations
- $$x = 2 \sin t + 1 \quad \text{and} \quad y = 2 \cos t - 3$$
- find $\frac{dy}{dx}$ and its value at $t = \frac{\pi}{4}$.
- 10** Evaluate:
- a** $\int_0^1 e^{2x} \cos(e^{2x}) dx$ **b** $\int_1^2 (x-1)\sqrt{2-x} dx$ **c** $\int_0^1 \frac{x-2}{x^2-7x+12} dx$
- 11** For the differential equation $\frac{dy}{dx} = -2x^2$ with $y = 2$ when $x = 1$, find y_3 using Euler's method with step size 0.1.
- 12** Find the volume of the solid formed when the region bounded by the x -axis and the curve with equation $y = a - \frac{x^2}{16a^3}$, where $a > 0$, is rotated about the y -axis.
- 13** A particle is moving in a straight line and is subject to a retardation of $1 + v^2$ m/s², where v m/s is the speed of the particle at time t seconds. The initial speed is u m/s. Find an expression for the distance travelled, in metres, for the particle to come to rest.
- 14** A particle falls vertically from rest such that the acceleration, a m/s², is given by $a = g - 0.4v$, where v m/s is the speed at time t seconds. Find an expression for v in terms of t in the form $v = A(1 - e^{-Bt})$, where A and B are positive constants. Hence state the values of A and B .
- 15** A train, when braking, has an acceleration, a m/s², given by $a = -\left(1 + \frac{v}{100}\right)$, where v m/s is the velocity. The brakes are applied when the train is moving at 20 m/s and it travels x metres after the brakes are applied. Find the distance that the train travels to come to rest in the form $x = A \ln(B) + C$, where A , B and C are positive constants.
- 16** Consider the graph of $f(x) = \frac{2x}{x^2 + 1}$.
- a** Show that $\frac{dy}{dx} = \frac{-2(x^2 - 1)}{(x^2 + 1)^2}$.
- b** Find the coordinates of any points of inflection.
- 17** Find an antiderivative of each of the following:
- a** $2xe^{-2x}$ **b** $x \sin(3x)$ **c** $\arccos(2x)$ **d** $4x^3 \ln(3x)$
- 18** Evaluate each of the following definite integrals:
- a** $\int_0^{\frac{\pi}{2}} x \cos\left(\frac{x}{2}\right) dx$ **b** $\int_0^2 x^2 e^{2x+2} dx$ **c** $\int_1^2 \ln\left(\frac{x}{2}\right) dx$

- 19 A particle is moving in a straight line such that its position, x metres, at time t seconds is given by

$$x = a \cos(\omega t) + b \sin(\omega t)$$

for positive constants a , b and ω .

- a** Show that the motion of the particle is simple harmonic.
b If $a = 3$, $b = 4$ and $\omega = 2$, find:
i the period of the motion
ii the amplitude of the motion
iii the maximum speed of the particle.

15B Multiple-choice questions

- 1 The graph of $y = f(x)$ is shown here.

Which one of the following best represents the graph of $y = \frac{1}{f(x)}$?

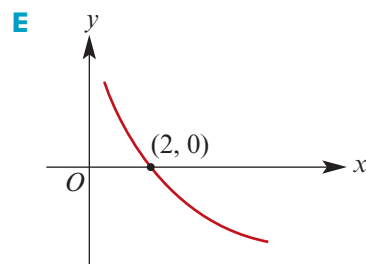
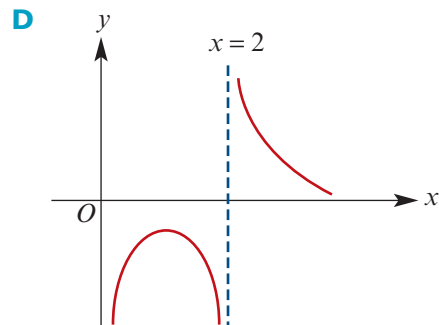
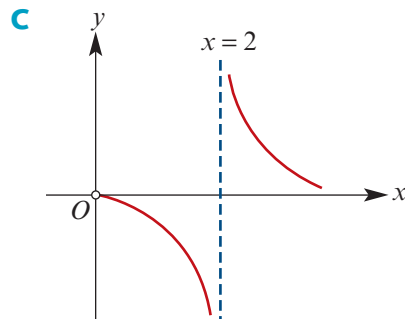
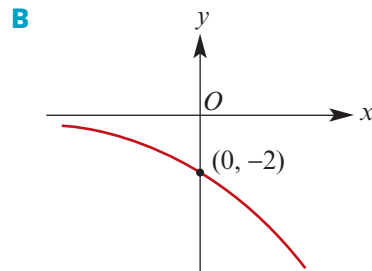
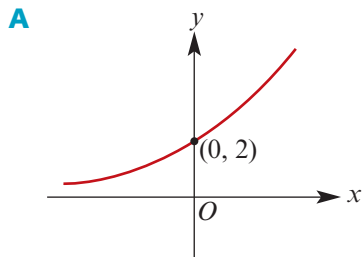
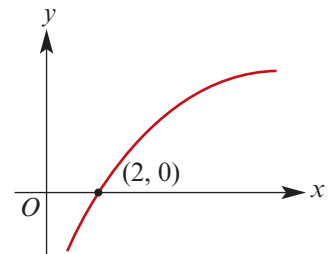

2 The graph of the function $f(x) = \frac{x^2 + x + 2}{x}$ has asymptotes

A $y = x$ and $y = x^2 + x + 2$

B $y = x$ and $y = x + 1$

C $x = 0$ and $y = x^2 + x + 2$

D $x = 0$ and $y = x + 1$

E $y = \frac{2}{x}$ and $y = x + 1$

3 One solution to the differential equation $\frac{d^2y}{dx^2} = 2 \cos x + 1$ is

A $y = -4 + \cos x + x$

B $y = 2 \sin x + x + 1$

C $y = -\frac{1}{4} \cos(2x) + \frac{x^2}{2} + x$

D $y = -2 \cos x + \frac{x^2}{2} + x$

E $y = 2 \cos x + \frac{x^2}{2} + x$

4 The graph shows the motion of an object which, in 4 seconds, covers a distance of

A 1 m

B 8 m

C 16 m

D -8 m

E 4 m

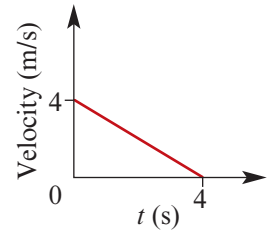

5 A curve passes through the point $(2, 3)$ and is such that the tangent to the curve at each point (a, b) is perpendicular to the tangent to $y = 2x^3$ at $(a, 2a^3)$. The equation of the curve can be found by using the differential equation

A $\frac{dy}{dx} = 2x^3$

B $\frac{dy}{dx} = -\frac{1}{6x^2}$

C $\frac{dy}{dx} = -6x^2$

D $\frac{dy}{dx} = \frac{2}{x} + c$

E $\frac{dy}{dx} = -\frac{1}{2x^3}$

6 A curve passes through the point $(1, 1)$ and is such that the gradient at any point is twice the reciprocal of the x -coordinate. The equation of this curve can be found by solving the differential equation with the given boundary condition

A $x \frac{dy}{dx} = 2, \quad y(1) = 1$

B $\frac{d^2y}{dx^2} = \frac{x}{2}, \quad y(1) = 1$

C $y \frac{dy}{dx} = 2, \quad y(1) = 1$

D $\frac{dy}{dx} = x, \quad y(1) = 1$

E $\frac{1}{2} \frac{dy}{dx} = x, \quad y(1) = 1$

7 If $\frac{dy}{dx} = 2 - x + \frac{1}{x^3}$, then

A $y = 2x - \frac{x^2}{2} + \frac{1}{2}x^2 + c$

B $y = -1 - \frac{3}{x^4} + c$

C $y = 2x - \frac{x^2}{2} - \frac{1}{2x^2} + c$

D $y = -\frac{x^2}{2} - \frac{3}{x^4} + c$

E $y = -1 - \frac{1}{2x^2}$

- 8** Car P leaves a garage, accelerates at a constant rate to a speed of 10 m/s and continues at that speed. Car Q leaves the garage 5 seconds later, accelerates at the same rate as car P to a speed of 15 m/s and continues at that speed until it hits the back of car P . Which one of the following pairs of graphs represents the motion of these cars?

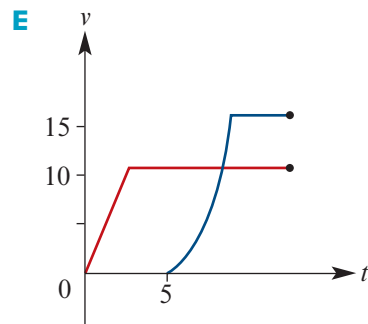
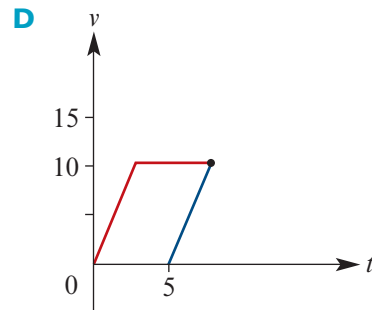
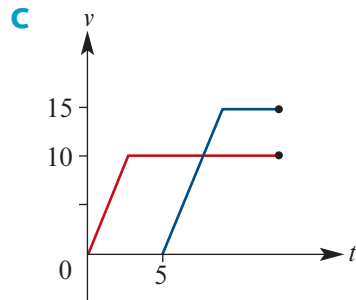
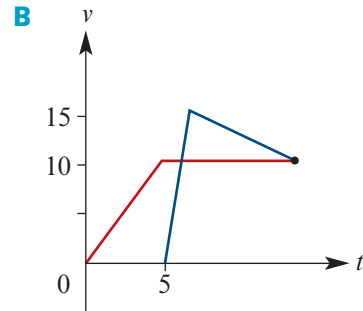
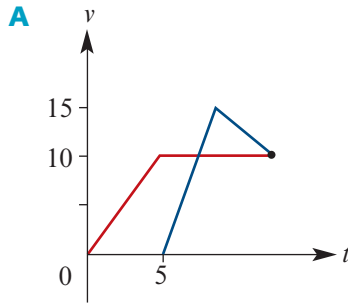

- 9** At a certain instant, a sphere is of radius 10 cm and the radius is increasing at a rate of 2 cm/s. The rate of increase (in cm^3/s) of the volume of the sphere is
- A** 80π **B** $\frac{800\pi}{3}$ **C** 400π **D** 800π **E** $\frac{8000\pi}{3}$
- 10** $\frac{d}{d\theta}(\ln(\sec \theta + \tan \theta))$ equals
- A** $\sec \theta$ **B** $\sec^2 \theta$ **C** $\sec \theta \tan \theta$ **D** $\cot \theta - \tan \theta$ **E** $\tan \theta$
- 11** A particle is moving along the x -axis such that $x = 3 \cos(2t)$ at time t . When $t = \frac{\pi}{2}$, the acceleration of the particle in the positive x -direction is
- A** -12 **B** -6 **C** 0 **D** 6 **E** 12

- 12** A container initially holds 20 litres (L) of water. A salt solution of concentration 3 g/L is poured into the container at a rate of 2 L/min. The mixture is kept uniform by stirring and flows out at a rate of 2 L/min. If Q g is the amount of salt in the container t minutes after pouring begins, then Q satisfies the equation

A $\frac{dQ}{dt} = \frac{Q}{10}$

B $\frac{dQ}{dt} = Q$

C $\frac{dQ}{dt} = 6 - \frac{Q}{10}$

D $\frac{dQ}{dt} = 6 - \frac{Q}{10+t}$

E $\frac{dQ}{dt} = 6 - \frac{Q}{20}$

- 13** A car starts from rest and accelerates for 10 seconds at a constant rate until it reaches a speed of 60 km/h. It travels at constant speed for 1 minute and then decelerates for 5 seconds at a constant rate until it reaches a speed of 45 km/h. Which one of the following best represents the car's journey?

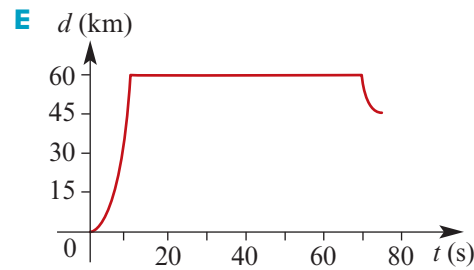
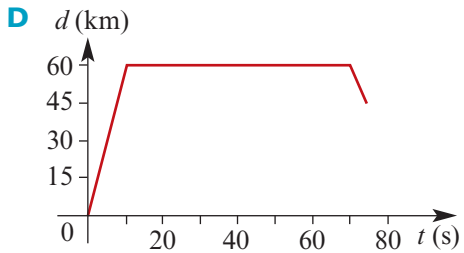
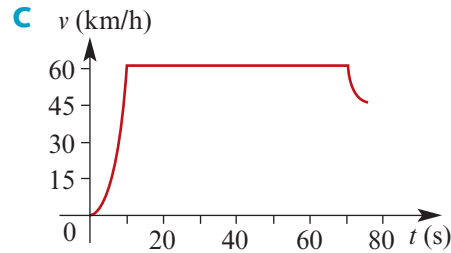
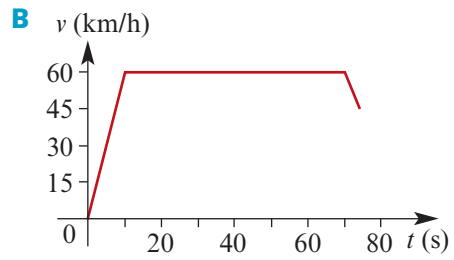
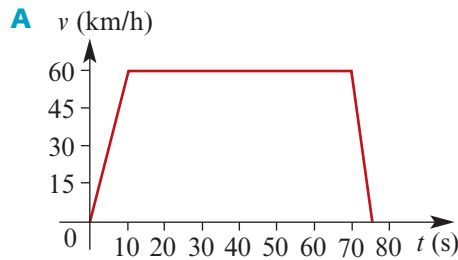

- 14** The equation of the particular member of the family of curves defined by $\frac{dy}{dx} = 3x^2 + 1$ that passes through the point (1, 3) is

A $y = 6x$

B $y = x^3 + x^2 + 1$

C $y = x^3 + x + 1$

D $y = x^3 + x + 3$

E $y = \frac{x^3}{3} + x$

- 15** One solution of the differential equation $\frac{d^2y}{dx^2} = e^{3x}$ is
A $y = 3e^{3x}$ **B** $y = \frac{1}{3}e^{3x}$ **C** $y = \frac{1}{3}e^{3x} + x$ **D** $y = 9e^{3x} + x$ **E** $y = \frac{1}{9}e^{3x} + x$
- 16** A body initially travelling at 12 m/s is subject to a constant deceleration of 4 m/s². The time taken to come to rest (t seconds) and the distance travelled before it comes to rest (s metres) are
A $t = 3, s = 24$ **B** $t = 3, s = 18$ **C** $t = 3, s = 8$
D $t = 4, s = 18$ **E** $t = 4, s = 8$
- 17** If $y = 1 - \sin(\cos^{-1} x)$, then $\frac{dy}{dx}$ equals
A $\frac{x}{\sqrt{1-x^2}}$ **B** $-x$ **C** $\cos(\sqrt{1-x^2})$
D $-\cos(\sqrt{1-x^2})$ **E** $-\cos(\cos^{-1} x)$

- 18** A bead moves along a straight wire with a constant velocity for 2 seconds and then its speed decreases at a constant rate to zero. The velocity–time graph illustrating this could be

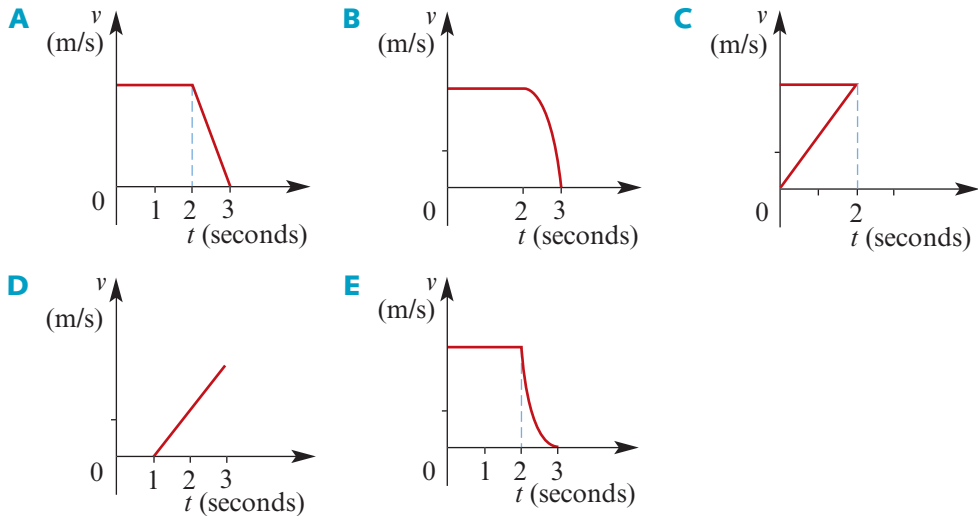

- 19** If $x = 2 \sin^2(y)$, then $\frac{dy}{dx}$ equals
A $4 \sin(y)$ **B** $\frac{1}{2} \operatorname{cosec}(2y)$ **C** $4\sqrt{\frac{x}{2}}$ **D** $2\sqrt{2x}$ **E** $\frac{1}{2} \sin^{-1}(2y)$
- 20** The rate of decay of a radioactive substance is proportional to the amount, x , of the substance present. This is described by the differential equation $\frac{dx}{dt} = -kx$, where k is a positive constant. Given that initially $x = 20$ and that $x = 5$ when $t = 20$, the time at which $x = 2$ is closest to
A 22.33 **B** 10.98 **C** 50 **D** 30.22 **E** 33.22

21 $\int_0^{\frac{\pi}{3}} \tan^2 x \sec^2 x \, dx$ equals

- A $\sqrt{3}$ B 3 C $\frac{\pi^3}{81}$ D $\frac{\pi^2}{9}$ E none of these

- 22 The velocity–time graph shows the motion of a tram between two stops. The distance between the stops, in metres, is

- A 300 B 360 C 405
D 450 E 570

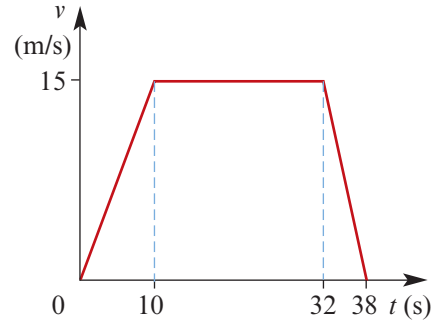

- 23 Assume that $\dot{y} = e^x + e^{-2x}$. If $y = 0$ and $\dot{y} = \frac{1}{2}$ when $x = 0$, then

- A $y = e^x + \frac{1}{4}e^{-2x} - \frac{5}{4}$ B $y = e^x + e^{-2x} - \frac{1}{2}$ C $y = e^x + e^{-2x}$
D $y = e^x + e^{-2x} + \frac{1}{2}$ E $y = e^x + e^{-2x} + \frac{5}{4}x - \frac{5}{4}$

- 24 If $\frac{dy}{dx} = 2y + 1$ and $y = 3$ when $x = 0$, then

- A $y = \frac{7e^{2x} - 1}{2}$ B $y = \frac{1}{2} \ln(2x + 1)$ C $y = y^2 + y + 1$
D $y = e^{2x}$ E $y = \frac{2e^{2x} + 1}{7}$

- 25 A rock falls from the top of a cliff 45 metres high ($g = -10 \text{ m/s}^2$). The rock's speed (in m/s) just before it hits the ground is

- A 5 B 10 C 20 D 30 E 40

- 26 The velocity, v m/s, of a particle at time t seconds is given by $v = t - t^2$, $t \geq 0$. The acceleration (in m/s^2) at time $t = 5$ is

- A -20 B -9 C 11 D 1 E 9

27 $\int_0^{\sqrt{3}} \frac{2x + 3}{9 + x^2} \, dx$ is closest to

- A 0.7 B 0.8 C 0.9 D 1.0 E 1.1

- 28 If $y = x \tan^{-1}(x)$, then $\frac{dy}{dx} = \frac{x}{1 + x^2} + \tan^{-1}(x)$. It follows that an antiderivative of $\tan^{-1}(x)$ is

- A $x \tan^{-1}(x)$ B $x \tan^{-1}(x) - \frac{x}{1 + x^2}$ C $x \tan^{-1}(x) - \ln(\sqrt{1 + x^2})$
D $\frac{1}{1 + x^2} + \frac{1}{x} \tan^{-1}(x)$ E $\frac{x}{1 + x^2}$

- 29** The velocity–time graph shows the motion of a train between two stations. The distance between the stations, in metres, is

A 2500 **B** 2900 **C** 3000
D 3400 **E** 5800

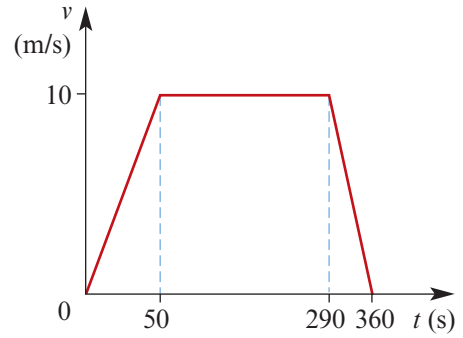

- 30** If $\frac{dy}{dx} = x^2 + x$ and $x = -3$ when $y = -\frac{1}{2}$, then

A $y = \frac{1}{3}x^3 + \frac{1}{2}x^2 - 4$ **B** $y = \frac{1}{3}x^3 - \frac{1}{2}x^2 + 4$ **C** $y = -\frac{1}{3}x^3 + \frac{1}{2}x^2 - 4$
D $y = \frac{1}{3}x^3 + \frac{1}{2}x^2 + 4$ **E** $y = -\frac{1}{3}x^3 + \frac{1}{2}x^2 + 4$

- 31** The equation of the particular member of the family of curves defined by $\frac{dy}{dx} = 1 - e^{-x}$ that passes through the point (0, 6) is

A $y = x - e^{-x} + 5$ **B** $y = x + e^{-x} + 5$ **C** $y = x + e^{-x} + 7$
D $y = x + e^{-x} + 6$ **E** $y = x - e^{-x} + 6$

- 32** If $y = \sin^{-1}(\sqrt{1-x})$, then $\frac{dy}{dx}$ equals

A $\cos^{-1}(\sqrt{1+x})$ **B** $\frac{1}{\sqrt{x}}$ **C** $\frac{1}{\sqrt{1-x}}$
D $\frac{\sqrt{1-x}}{x}$ **E** $-\frac{1}{2\sqrt{x(1-x)}}$

- 33** This is the graph of

A $y = \frac{1}{(x-1)(x-2)}$
B $y = \frac{x}{(x-1)(x-2)}$
C $y = \frac{(x-1)(x-2)}{x}$
D $y = \frac{1}{(x-2)(x-1)^2}$
E $y = \frac{1}{(x-1)(x-2)^2}$

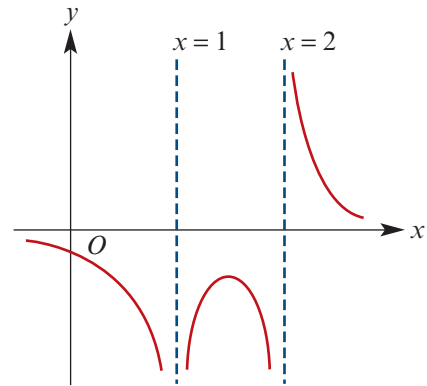

- 34** The values of m for which $y = e^{mx}$ satisfies the differential equation $\frac{d^2y}{dx^2} - 2\frac{dy}{dx} - 3y = 0$ are

A $m = 1, m = 2$ **B** $m = 3, m = -1$ **C** $m = -2, m = 3$
D $m = \pm 1$ **E** $m = \pm 3$

35 A particle is projected vertically upwards from ground level with a velocity of 20 m/s and returns to the point of projection. The velocity–time graph illustrating this could be

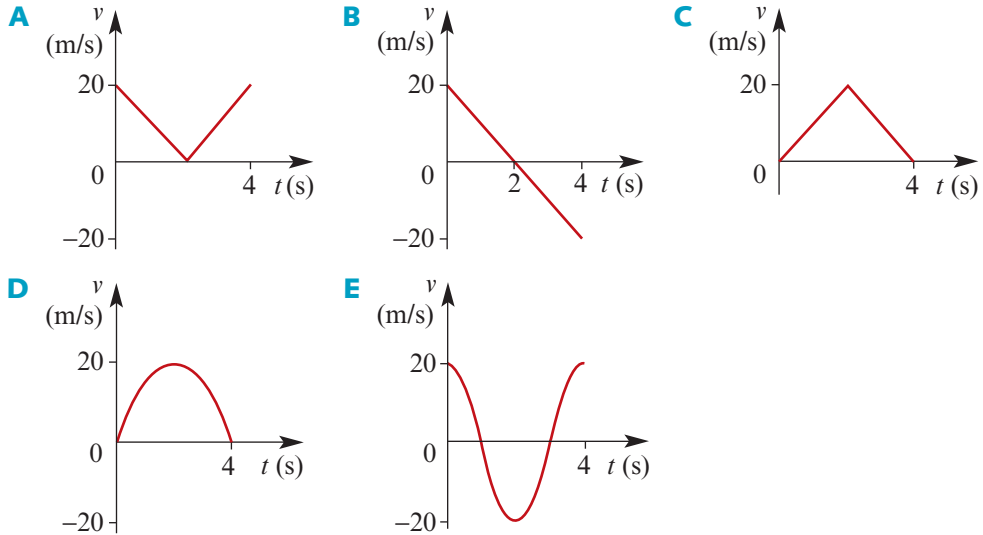

36 A car departs from a checkpoint, accelerating initially at 5 m/s^2 but with the rate of acceleration decreasing until a maximum speed of 25 m/s is reached. It continues at 25 m/s for some time, then slows with constant deceleration until it comes to rest. Which one of the following graphs best represents the motion of the car?

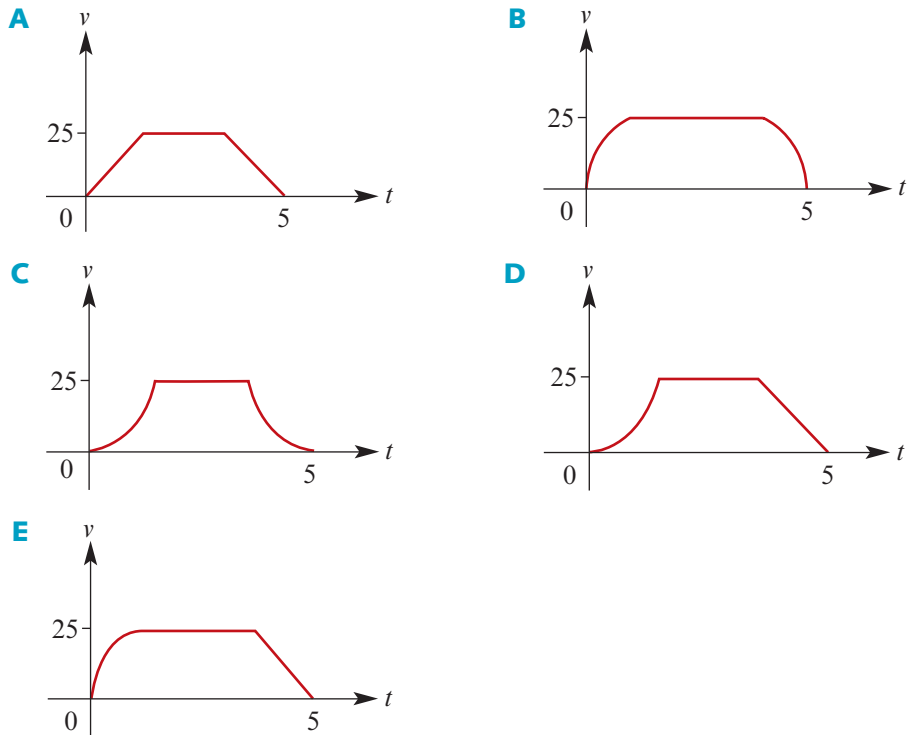

37 Which one of the following differential equations is satisfied by $y = e^{3x}$ for all values of x ?

- A** $\frac{d^2y}{dx^2} + 9y = 0$ **B** $\frac{d^2y}{dx^2} - 9y = 0$ **C** $\frac{d^2y}{dx^2} + \frac{y}{9} = 0$
D $\frac{d^2y}{dx^2} - 27y = 0$ **E** $\frac{d^2y}{dx^2} - 8y = 0$

38 A particle has initial velocity 3 m/s and its acceleration t seconds later is given by $(6t^2 + 5t - 3)$ m/s². After 2 seconds, its velocity in m/s is

- A** 15 **B** 18 **C** 21 **D** 27 **E** 23

39 A particle starts from rest at a point O and moves in a straight line so that after t seconds its velocity, v , is given by $v = 4 \sin(2t)$. Its displacement from O is given by

- A** $s = 8 \cos(2t)$ **B** $s = 2 \cos(2t)$ **C** $s = -2 \cos(2t)$
D $s = 8 \cos(2t) - 8$ **E** $s = 2 - 2 \cos(2t)$

40 The volume of the solid of revolution when the shaded region of the diagram is rotated about the y -axis is given by

- A** $\pi \int_0^{\frac{1}{2} \ln 2} e^{2x} dx$
B $\pi \int_0^2 \frac{1}{2} \ln y dy$
C $\pi \left(\ln 2 - \int_0^{\frac{1}{2} \ln 2} e^{2x} dx \right)$
D $\pi \int_0^2 \frac{1}{4} (\ln y)^2 dy - \frac{\pi}{2}$
E $\pi \int_1^2 \frac{1}{4} (\ln y)^2 dy$

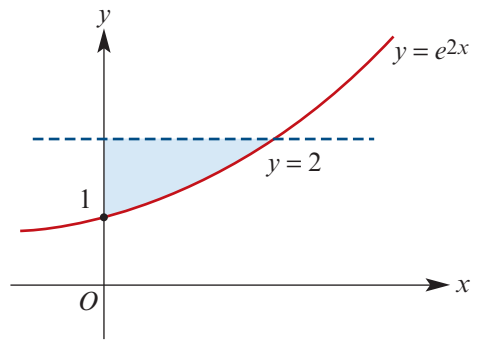

41 The area of the shaded region in the graph is

- A** $\int_0^1 f(x) dx + \int_0^{-2} f(x) dx$
B $\int_{-2}^1 f(x) dx$
C $\int_{-2}^0 f(x) dx + \int_0^1 f(x) dx$
D $-\int_1^0 f(x) dx + \int_0^{-2} f(x) dx$
E $-\int_0^{-2} f(x) dx + \int_0^1 f(x) dx$

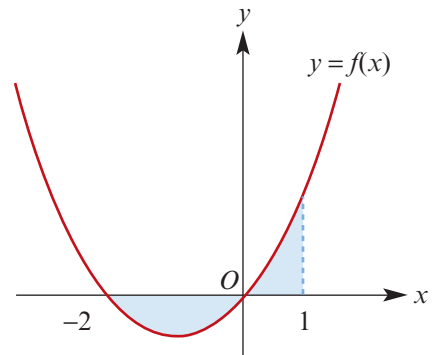

42 An arrangement of the integrals

$$P = \int_0^{\frac{\pi}{2}} \sin^2 x dx, \quad Q = \int_0^{\frac{\pi}{4}} \cos^2 x dx, \quad R = \int_0^{\frac{\pi}{4}} \sin^2 x dx$$

in ascending order of magnitude is

- A** P, R, Q **B** Q, P, R **C** R, Q, P **D** R, P, Q **E** Q, R, P

43 The value of $\int_0^1 \frac{e^{2x}}{e^{2x} + 1} dx$ is

- A** $\frac{1}{2}(e^2 + 1)$ **B** $\frac{1}{2} \ln(e^2 - 1)$ **C** $\frac{1}{2} \ln\left(\frac{e^2 + 1}{2}\right)$
D $\ln\left(\frac{e^2 + 1}{2}\right)$ **E** $2 \ln\left(\frac{e^2 + 1}{2}\right)$

44 In the diagram on the right, the area of the region enclosed between the graphs with equations $y = x^2 - 9$ and $y = 9 - x^2$ is given by

- A** $\int_{-3}^3 2x^2 - 18 dx$ **B** $\int_{-3}^3 18 - 2x^2 dx$
C 0 **D** $\int_{-9}^9 2x^2 - 18 dx$
E $\int_{-9}^9 18 - 2x^2 dx$

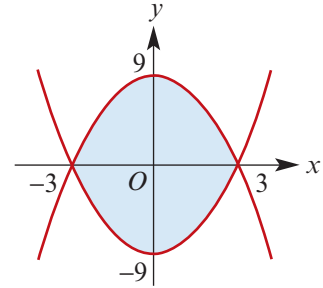

45 The volume of the solid of revolution when the shaded region of this graph is rotated about the x -axis is given by

- A** $\pi \int_0^1 4e^{4x} - 4 dx$
B $\pi \int_0^1 e^{2x} - 4 dx$
C $\pi \int_0^1 (2e^{2x} - 2)^2 dx$
D $\pi \int_2^{2e} 1 dy$
E $\pi \int_0^1 4 - 4e^{2x} dx$

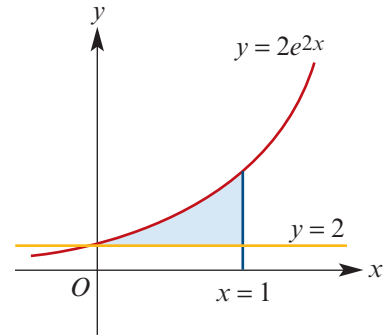

46 A body moves in a straight line so that its acceleration (in m/s^2) at time t seconds is given by $\frac{d^2x}{dt^2} = 4 - e^{-t}$. If the body's initial velocity is 3 m/s , then when $t = 2$ its velocity (in m/s) is

- A** e^{-2} **B** $2 + e^{-2}$ **C** $8 + e^{-2}$ **D** $10 + e^{-2}$ **E** $12 + e^{-2}$

47 A particle moves with velocity v m/s . The distance travelled, in metres, by the particle in the first 8 seconds is

- A** 40 **B** 50
C 60 **D** 70
E 80

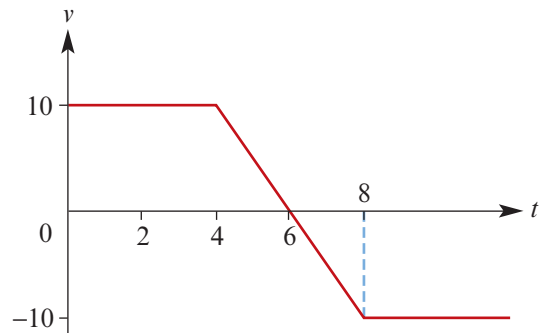

- 48 The area of the region shaded in the graph is equal to

- A $\int_0^c f(x) - g(x) dx$
 B $\int_b^c f(x) - g(x) dx + \int_0^b f(x) - g(x) dx$
 C $\int_b^c f(x) - g(x) dx + \int_b^0 f(x) - g(x) dx$
 D $\int_b^c f(x) dx + \int_0^b g(x) dx$
 E $\int_0^c f(x) + g(x) dx$

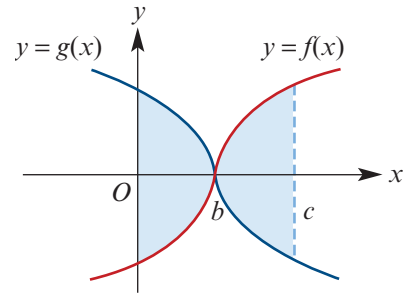

- 49 An antiderivative of $\cos(3x + 1)$ is

- A $-3 \sin(3x + 1)$ B $-\frac{1}{3} \cos(3x + 1)$ C $3 \cos(3x + 1)$
 D $-\frac{1}{3} \sin(3x + 1)$ E $\frac{1}{3} \sin(3x + 1)$

- 50 $\int_0^{\frac{\pi}{4}} \tan x \sec^2 x dx$ is equal to

- A $\int_0^1 u du$ B $\int_0^{\frac{\pi}{4}} u^2 du$ C $-\int_0^1 u^2 du$
 D $\int_0^1 \sqrt{1-u^2} du$ E $\int_0^{\frac{\pi}{4}} \frac{u^2}{2} du$

- 51 The value of $\int_0^2 2e^{2x} dx$ is

- A e^4 B $e^4 - 1$ C $4e^4$ D $\frac{1}{2}e^4$ E $1 - e^4$

- 52 An antiderivative of $\frac{\sin x}{\cos^2 x}$ is

- A $\sec x$ B $\tan x \cos x$ C $\tan^2 x$ D $\cot x \sec x$ E $\sec^2 x$

- 53 A partial fraction expansion of $\frac{1}{(2x+6)(x-4)}$ shows that it has an antiderivative $\frac{a}{2} \ln(2x+6) + b \ln(x-4)$, where

- A $a = -\frac{1}{7}, b = \frac{1}{14}$ B $a = 1, b = 1$ C $a = \frac{1}{2}, b = \frac{1}{2}$
 D $a = -1, b = -1$ E $a = \frac{1}{11}, b = \frac{1}{7}$

- 54 $\int_0^1 x\sqrt{2x+1} dx$ is equal to

- A $\frac{1}{2} \int_0^1 (u-1)\sqrt{u} du$ B $\int_0^1 u\sqrt{u} du$ C $\frac{1}{4} \int_1^3 \sqrt{u} du$
 D $2 \int_1^3 \sqrt{u} du$ E $\frac{1}{4} \int_1^3 u^{\frac{3}{2}} - u^{\frac{1}{2}} du$

- 55 If $\int_0^{\frac{\pi}{6}} \sin^n x \cos x dx = \frac{1}{64}$, then n equals

- A 6 B 5 C 4 D 3 E 7

56 Of the integrals

$$\int_0^\pi \sin^3 \theta \cos^3 \theta \, d\theta, \quad \int_0^2 t^3(4-t^2)^2 \, dt, \quad \int_0^\pi x^2 \cos x \, dx$$

one is negative, one is positive and one is zero. Without evaluating them, determine which is the correct order of signs.

- A** $-0+$ **B** $+ -0$ **C** $+0-$ **D** $0-+$ **E** $0+-$

57 $\int_0^{\frac{\pi}{4}} \cos(2x) \, dx$ is equal to

A $\frac{1}{2} \int_0^{\frac{\pi}{2}} \sin(2x) \, dx$ **B** $\frac{1}{2} \int_0^{\frac{\pi}{2}} \cos(2x) \, dx$ **C** $\int_{-\frac{\pi}{4}}^0 \sin(2x) \, dx$

D $\frac{1}{2} \int_0^{\frac{\pi}{2}} \sin(4x) \, dx$ **E** $\frac{1}{2} \int_0^{\frac{\pi}{2}} \cos(4x) \, dx$

58 $\int_{-a}^a \tan x \, dx$ can be evaluated if a equals

A $\frac{\pi}{2}$ **B** $\frac{3\pi}{2}$ **C** $\frac{\pi}{4}$ **D** π **E** $\frac{-3\pi}{2}$

59 An antiderivative of $\frac{2x}{\sqrt{x^2-1}}$ is

A $2\sqrt{x^2-1}$ **B** $\frac{x^2}{\sqrt{x^2-1}}$ **C** $2x\sqrt{x^2-1}$ **D** $\frac{2}{\sqrt{x^2-1}}$ **E** $\frac{2}{x\sqrt{x^2-1}}$

60 If $\frac{3}{(x-1)(2x+1)} = \frac{A}{x-1} + \frac{B}{2x+1}$, for all $x \in \mathbb{R} \setminus \{1, -\frac{1}{2}\}$, then

A $A = 4, B = 3$ **B** $A = 1, B = 4$ **C** $A = 1, B = -2$

D $A = 3, B = 3$ **E** $A = 2, B = 4$

61 $\int \tan x \, dx$ is equal to

A $\sec^2 x + c$ **B** $\ln(\cos x) + c$ **C** $\ln(\sec x) + c$

D $\ln(\sin x) + c$ **E** $\frac{1}{2} \tan^2 x + c$

62 The volume of the solid of revolution formed by rotating the region bounded by the curve $y = 2 \sin x - 1$ and the lines with equations $x = 0$, $x = \frac{\pi}{4}$ and $y = 0$ about the x -axis is given by

A $\int_0^{\frac{\pi}{4}} \pi^2(2 \sin x - 1)^2 \, dx$ **B** $\int_0^{\frac{\pi}{4}} \pi(4 \sin^2 x - 1) \, dx$ **C** $\int_0^{\frac{\pi}{4}} \pi(1 - 2 \sin x)^2 \, dx$

D $\int_0^{\frac{\pi}{4}} (2 \sin x - 1)^2 \, dx$ **E** $\int_0^{\frac{\pi}{4}} \pi(2 \sin x - 1) \, dx$

63 The area of the region bounded by the graphs of $f: \left[0, \frac{\pi}{2}\right) \rightarrow \mathbb{R}, f(x) = \sin x$ and

$g: \left[0, \frac{\pi}{2}\right) \rightarrow \mathbb{R}, g(x) = \sin(2x)$ is

A $\int_0^{\frac{\pi}{2}} \sin x - x \sin(2x) \, dx$ **B** $\int_0^{\frac{\pi}{3}} \sin(2x) - \sin x \, dx$ **C** $\int_{\frac{\pi}{4}}^{\frac{\pi}{2}} \sin(2x) - \sin x \, dx$

D $\int_{\frac{\pi}{4}}^{\frac{\pi}{2}} \sin x - \sin(2x) \, dx$ **E** $\int_{\frac{\pi}{3}}^{\frac{\pi}{4}} \sin(2x) - \sin x \, dx$

- 64** The shaded region is bounded by the curve $y = f(x)$, the coordinate axes and the line $x = a$. Which one of the following statements is false?

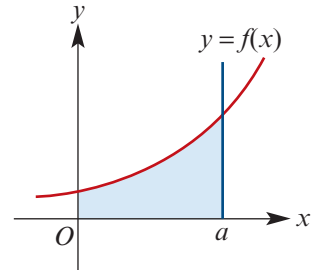

- A** The area of the shaded region is $\int_0^a f(x) dx$.
B The volume of the solid of revolution formed by rotating the region about the x -axis is $\int_0^a \pi(f(x))^2 dx$.
C The volume of the solid of revolution formed by rotating the region about the y -axis is $\int_{f(0)}^{f(a)} \pi x^2 dy$.
D The area of the shaded region is greater than $af(0)$.
E The area of the shaded region is less than $af(a)$.

65 $\int \frac{1}{\sqrt{9-4x^2}} dx$ equals

- A** $\frac{1}{3} \sin^{-1}\left(\frac{3x}{2}\right) + c$ **B** $\frac{1}{3} \sin^{-1}\left(\frac{2x}{3}\right) + c$ **C** $\frac{1}{2} \sin^{-1}\left(\frac{3x}{2}\right) + c$
D $\frac{1}{2} \sin^{-1}\left(\frac{2x}{3}\right) + c$ **E** $\sin^{-1}\left(\frac{2x}{3}\right) + c$

66 $\int_{-\frac{1}{2}}^{\frac{1}{2}} \frac{1}{(1-x)^2} dx$ equals

- A** $\frac{4}{3}$ **B** $-\frac{4}{3}$ **C** 1 **D** $\ln 3$ **E** $-\ln 3$

67 $\int \frac{1}{\sqrt{\frac{1}{9}-x^2}} dx$ equals

- A** $\sin^{-1}\left(\frac{x}{3}\right) + c$ **B** $\sin^{-1}(3x) + c$ **C** $\sin^{-1}\left(\frac{3}{x}\right) + c$
D $\frac{3}{2} \ln\left(\frac{1}{9}-x^2\right) + c$ **E** $\frac{3}{2} \ln\left(\frac{1+3x}{1-3x}\right) + c$

68 $\int \frac{1}{9+4x^2} dx$ is

- A** $\frac{1}{9} \tan^{-1}\left(\frac{2x}{9}\right) + c$ **B** $\frac{1}{3} \tan^{-1}\left(\frac{2x}{3}\right) + c$ **C** $\frac{1}{6} \tan^{-1}\left(\frac{2x}{3}\right) + c$
D $9 \tan^{-1}\left(\frac{2x}{9}\right) + c$ **E** $\frac{3}{2} \tan^{-1}\left(\frac{2x}{3}\right) + c$

69 $\frac{d}{d\theta}(\sec^3 \theta)$ is

- A** $3 \sec^3 \theta \tan \theta$ **B** $3 \sec^2 \theta$ **C** $3 \sec^2 \theta \tan \theta$
D $3 \sec^2 \theta \tan^2 \theta$ **E** $3 \sec \theta \tan^2 \theta$

70 If $\int \sin^2(4x) \cos(4x) dx = k \sin^3(4x) + c$, then k is

- A** $\frac{1}{12}$ **B** $\frac{1}{4}$ **C** $\frac{1}{3}$ **D** $-\frac{1}{4}$ **E** $-\frac{1}{3}$

- 71** $\frac{x+7}{x^2-x-6}$ written as partial fractions is
- A** $\frac{2}{x-3} - \frac{1}{x+2}$ **B** $\frac{2}{x+2} - \frac{1}{x-3}$ **C** $\frac{9}{5(x-2)} - \frac{9}{5(x+3)}$
D $\frac{4}{5(x-2)} - \frac{9}{5(x+3)}$ **E** $\frac{1}{x+2} + \frac{2}{x-3}$
- 72** If $y = \sin^{-1}(3x)$, then $\frac{dy}{dx}$ equals
- A** $-\frac{3 \cos(3x)}{\sin^2(3x)}$ **B** $3 \cos^{-1}(3x)$ **C** $\frac{1}{\sqrt{1-9x^2}}$ **D** $\frac{3}{\sqrt{1-9x^2}}$ **E** $\frac{1}{3\sqrt{1-9x^2}}$
- 73** $\frac{d}{dx}(\ln(\tan x))$ equals
- A** $\ln(\sec^2 x)$ **B** $\cot x$ **C** $\frac{2}{\sin(2x)}$ **D** $\frac{1}{\sin(2x)}$ **E** $\sec x$
- 74** The general solution of the differential equation $\frac{dy}{dx} + y = 1$ (with P being an arbitrary constant) is
- A** $2x + (1-y)^2 = P$ **B** $2x - (1-y)^2 = P$ **C** $y = 1 + Pe^x$
D $y = 1 + Pe^{-x}$ **E** $y = Pe^{-x} - 1$
- 75** $\int \frac{x^2}{(x^3+1)^{\frac{1}{2}}} dx$ equals
- A** $\frac{1}{3} \ln((x^3+1)^{\frac{1}{2}}) + c$ **B** $\frac{2}{3} \ln((x^3+1)^{\frac{1}{2}}) + c$ **C** $\frac{2}{3}(x^3+1)^{\frac{1}{2}} + c$
D $\frac{1}{6}(x^3+1)^{\frac{1}{2}} + c$ **E** $\frac{1}{3}(x^3+1)^{\frac{1}{2}} + c$
- 76** Air leaks from a spherical balloon at a constant rate of $2 \text{ m}^3/\text{s}$. When the radius of the balloon is 5 m, the rate (in m^2/s) at which the surface area is decreasing is
- A** $\frac{4}{5}$ **B** $\frac{8}{5}$ **C** $\frac{1}{50}\pi$ **D** $\frac{1}{100}\pi$ **E** none of these
- 77** $\int_0^{\frac{\sqrt{3}}{2}} \frac{x}{\sqrt{1-x^2}} dx$ equals
- A** $\frac{1}{4}$ **B** $\frac{1}{2}$ **C** 1 **D** $\frac{\pi}{3}$ **E** $-\frac{1}{2}$
- 78** For $-1 < x < 1$, the integral $\int \frac{1}{1-x^2} dx$ can be written as
- A** $\frac{1}{2} \ln\left(\frac{1+x}{1-x}\right) + c$ **B** $\frac{1}{2} \ln\left(\frac{1-x}{1+x}\right) + c$ **C** $\ln\left(\frac{1+x}{1-x}\right) + c$
D $\frac{1}{2} \ln((1-x)(1+x)) + c$ **E** $\ln((1-x)(1+x)) + c$

- 79** Which one of the following is not an equation of simple harmonic motion, where x is the position of a particle at time t ?
- A** $x = 5 \sin(t) + 1$ **B** $x = 2 \sin(-3t)$ **C** $x = 2 \cos(3t) + 1$
D $x = \sin(2t) + \sin(3t)$ **E** $x = -2 \cos(3t)$
- 80** A particle is in simple harmonic motion with $\ddot{x} = -16x + 16$, where x m is the position of the particle relative to the origin O at time t s. The centre of the motion, $x = c$, and the period of the motion, T s, are given by
- A** $c = 1, T = \frac{\pi}{8}$ **B** $c = -1, T = \frac{\pi}{2}$ **C** $c = 1, T = \frac{\pi}{2}$
D $c = 16, T = \frac{\pi}{2}$ **E** $c = -16, T = \frac{\pi}{2}$

15C Extended-response questions

- 1** A bowl can be described as the solid of revolution formed by rotating the graph of $y = \frac{1}{4}x^2$ around the y -axis for $0 \leq y \leq 25$.
- a** Find the volume of the bowl.
- b** The bowl is filled with water and then, at time $t = 0$, the water begins to run out of a small hole in the base. The rate at which the water runs out is proportional to the depth, h , of the water at time t . Let V denote the volume of water at time t .
- i** Show that $\frac{dh}{dt} = \frac{-k}{4\pi}$, where $k > 0$.
- ii** Given that the bowl is empty after 30 seconds, find the value of k .
- iii** Find h in terms of t .
- iv** Find V in terms of t .
- c** Sketch the graph of:
- i** V against h **ii** V against t
- 2** **a** Sketch the curve with equation $y + 3 = \frac{6}{x - 1}$.
- b** Find the coordinates of the points where the line $y + 3x = 9$ intersects the curve.
- c** Find the area of the region enclosed between the curve and the line.
- d** Find the equations of two tangents to the curve that are parallel to the line.
- 3** Point O is the centre of a city with a population of 600 000. All of the population lives within 6 km of the city centre. The number of people who live within r km ($0 \leq r \leq 6$) of the city centre is given by $\int_0^r 2\pi k(6 - x)^{\frac{1}{2}} x^2 dx$.
- a** Find the value of k , correct to three significant figures.
- b** Find the number of people who live within 3 km of the city centre, correct to three significant figures.

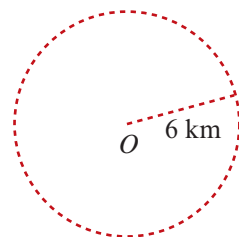

- 4** The vertical cross-section of a bucket is shown in this diagram. The sides are arcs of a parabola with the y -axis as the central axis and the horizontal cross-sections are circular. The depth is 36 cm, the radius length of the base is 10 cm and the radius length of the top is 20 cm.

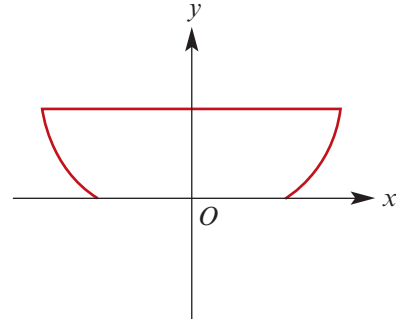

- a** Prove that the parabolic sides are arcs of the parabola $y = 0.12x^2 - 12$.
- b** Prove that the bucket holds 9π litres when full.

Water starts leaking from the bucket, initially full, at the rate given by $\frac{dv}{dt} = \frac{-\sqrt{h}}{A}$, where at time t seconds the depth is h cm, the surface area is A cm² and the volume is v cm³.

- c** Prove that $\frac{dv}{dt} = \frac{-3\sqrt{h}}{25\pi(h+12)}$.
- d** Show that $v = \pi \int_0^h \left(\frac{25y}{3} + 100 \right) dy$.
- e** Hence construct a differential equation expressing:
- i** $\frac{dv}{dh}$ as a function of h **ii** $\frac{dh}{dt}$ as a function of h
- f** Hence find the time taken for the bucket to empty.
- 5** A hemispherical bowl can be described as the solid of revolution generated by rotating $x^2 + y^2 = a^2$ about the y -axis for $-a \leq y \leq 0$. The bowl is filled with water. At time $t = 0$, water starts running out of a small hole in the bottom of the bowl, so that the depth of water in the bowl at time t is h cm. The rate at which the volume is decreasing is proportional to h . (All length units are centimetres.)
- a** **i** Show that, when the depth of water is h cm, the volume, V cm³, of water remaining is $V = \pi(ah^2 - \frac{1}{3}h^3)$, where $0 < h \leq a$.
- ii** If $a = 10$, find the depth of water in the hemisphere if the volume is 1 litre.
- b** Show that $\pi(2ah - h^2) \frac{dh}{dt} = -kh$, for a positive constant k .
- c** Given that the bowl is empty after time T , show that $k = \frac{3\pi a^2}{2T}$.
- d** If $a = 10$ and $T = 30$, find k (correct to three significant figures).
- e** Sketch the graph of:
- i** $\frac{dV}{dt}$ against h for $0 \leq h \leq a$ **ii** $\frac{dh}{dt}$ against h for $0 \leq h \leq a$
- f** Find the rate of change of the depth with respect to time when:
- i** $h = \frac{a}{2}$ **ii** $h = \frac{a}{4}$
- g** If $a = 10$ and $T = 30$, find the rate of change of depth with respect to time when there is 1 litre of water in the hemisphere.

- 6** Consider the function with rule $f(x) = \frac{1}{ax^2 + bx + c}$, where $a \neq 0$.
- Find $f'(x)$.
 - State the coordinates of the turning point and state the nature of this turning point if:
 - $a > 0$
 - $a < 0$
 - Assume that $b^2 - 4ac < 0$. Sketch the graph of $y = f(x)$, stating the equations of all asymptotes, if:
 - $a > 0$
 - $a < 0$
 - Now assume that $b^2 - 4ac = 0$. Sketch the graph of $y = f(x)$ if:
 - $a > 0$
 - $a < 0$
 - Finally, assume that $b^2 - 4ac > 0$ and $a > 0$. Sketch the graph of $y = f(x)$, stating the equations of all asymptotes.
- 7** Consider the family of curves with equations of the form $y = ax^2 + \frac{b}{x^2}$, where $a, b \in \mathbb{R}^+$.
- Find $\frac{dy}{dx}$.
 - State the coordinates of the turning points of a member of this family in terms of a and b , and state the nature of each.
 - Consider the family $y = ax^2 + \frac{1}{x^2}$. Show that the coordinates of the turning points are $\left(\frac{1}{\sqrt[3]{a}}, 2\sqrt[3]{a}\right)$ and $\left(\frac{-1}{\sqrt[3]{a}}, 2\sqrt[3]{a}\right)$.
- 8** Suppose that the time, T minutes, between successive trains at an inner-city platform is exponentially distributed with the probability density function

$$f(t) = \begin{cases} \frac{1}{6}e^{-\frac{t}{6}} & \text{if } t \geq 0 \\ 0 & \text{if } t < 0 \end{cases}$$

- If you arrive at the platform just as a train is leaving, what is the probability that you will have to wait at least 5 minutes for the next train? That is, find $\Pr(T \geq 5)$.
 - If you have waited at the platform for 5 minutes and no train has arrived, what is the probability that you will have to wait at least 5 minutes more for a train? That is, find $\Pr(T \geq 10 | T \geq 5)$.
 - In general, let X be an exponential random variable with parameter λ . Show that

$$\Pr(X \geq a + b | X \geq a) = \Pr(X \geq b)$$
 for all $a, b > 0$.
- 9**
- Evaluate $\int_0^{\frac{\pi}{4}} \tan^4 \theta \sec^2 \theta \, d\theta$.
 - Hence show that $\int_0^{\frac{\pi}{4}} \tan^6 \theta \, d\theta = \frac{1}{5} - \int_0^{\frac{\pi}{4}} \tan^4 \theta \, d\theta$.
 - Deduce that $\int_0^{\frac{\pi}{4}} \tan^6 \theta \, d\theta = \frac{13}{15} - \frac{\pi}{4}$.

- 10** A disease spreads through a population. Let p denote the proportion of the population who have the disease at time t . The rate of change of p is proportional to the product of p and the proportion $1 - p$ who do not have the disease.

When $t = 0$, $p = \frac{1}{10}$ and when $t = 2$, $p = \frac{1}{5}$.

- a** **i** Show that $t = \frac{1}{k} \ln\left(\frac{9p}{1-p}\right)$, where $k = \ln\left(\frac{3}{2}\right)$.
- ii** Hence show that $\frac{9p}{1-p} = \left(\frac{3}{2}\right)^t$.
- b** Find p when $t = 4$.
- c** Find p in terms of t .
- d** Find the values of t for which $p > \frac{1}{2}$.
- e** Sketch the graph of p against t .
- 11** A car moves along a straight level road. Its speed, v , is related to its displacement, x , by the differential equation $v \frac{dv}{dx} = \frac{p}{v} - kv^2$, where p and k are constants.

a Given that $v = 0$ when $x = 0$, show that $v^3 = \frac{1}{k}(p - pe^{-3x})$.

b Find $\lim_{x \rightarrow \infty} v$.

- 12** A projection screen is 6 metres in height and has its lower edge 2 metres above the eye level of an observer. The angle between the lines of sight of the upper and lower edges of the screen is θ . Let x m be the horizontal distance from the observer to the screen.

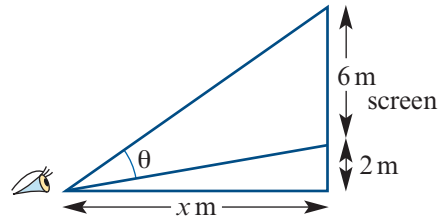

- a** Find θ in terms of x .
- b** Find $\frac{d\theta}{dx}$.
- c** What values can θ take?
- d** Sketch the graph of θ against x .
- e** If $1 \leq x \leq 25$, find the minimum value of θ .
- 13** A particle is oscillating between the points P and Q with simple harmonic motion. The midpoint of PQ is O . The particle's maximum acceleration is 16 m/s^2 and its speed at the midpoint of OP is $4\sqrt{3} \text{ m/s}$. Find:
- a** the length of PQ
- b** the period of the motion
- c** the time taken for the particle to travel directly from the midpoint of OP to the midpoint of OQ .

- 14** An open rectangular tank is to have a square base. The capacity of the tank is to be 4000 m^3 . Let $x \text{ m}$ be the length of an edge of the square base and $A \text{ m}^2$ be the amount of sheet metal used to construct the tank.
- Show that $A = x^2 + \frac{16\,000}{x}$.
 - Sketch the graph of A against x .
 - Find, correct to two decimal places, the value(s) of x for which 2500 m^2 of sheet metal is used.
 - Find the value of x for which A is a minimum.
- 15** A closed rectangular box is made of very thin sheet metal and its length is three times its width. If the volume of the box is 288 cm^3 , show that its surface area, $A(x) \text{ cm}^2$, is given by $A(x) = \frac{768}{x} + 6x^2$, where $x \text{ cm}$ is the width of the box. Find the minimum surface area of the box.

- 16** This container has an open rectangular horizontal top, $PQSR$, and parallel vertical ends, PQO and RST . The ends are parabolic in shape. The x -axis and y -axis intersect at O , with the x -axis horizontal and the y -axis the line of symmetry of the end PQO . The dimensions are shown on the diagram.

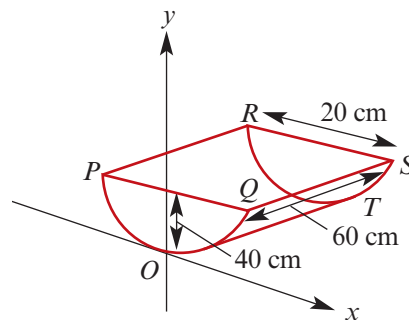

- Find the equation of the parabolic arc QOP .
 - If water is poured into the container to a depth of $y \text{ cm}$, with a volume of $V \text{ cm}^3$, find the relationship between V and y .
 - Calculate the depth, to the nearest mm, when the container is half full.
 - Water is poured into the empty container so that the depth is $y \text{ cm}$ at time t seconds. If the water is poured in at the rate of $60 \text{ cm}^3/\text{s}$, construct a differential equation expressing $\frac{dy}{dt}$ as a function of y and solve it.
 - Calculate, to the nearest second:
 - how long it will take the water to reach a depth of 20 cm
 - how much longer it will take for the container to be completely full.
- 17** Moving in the same direction along parallel tracks, objects A and B pass the point O simultaneously with speeds of 20 m/s and 10 m/s respectively. From then on, the deceleration of A is $\frac{v^3}{400} \text{ m/s}^2$ and the deceleration of B is $\frac{v^2}{100} \text{ m/s}^2$, when the speeds are $v \text{ m/s}$.
- Find the speeds of A and B at time t seconds after passing O .
 - Find the positions of A and B at time t seconds after passing O .
 - Use a CAS calculator to plot the graphs of the positions of objects A and B .
 - Use a CAS calculator to find, to the nearest second, when the objects pass.

- 18** A stone, initially at rest, is released and falls vertically. Its velocity, v m/s, at time t s after release is determined by the differential equation $5 \frac{dv}{dt} + v = 50$.
- Find an expression for v in terms of t .
 - Find v when $t = 47.5$.
 - Sketch the graph of v against t .
 - Let x be the displacement from the point of release at time t . Find an expression for x in terms of t .
 - Find x when $t = 6$.
- 19** The rate of change of a population, y , is given by $\frac{dy}{dt} = \frac{2y(N-y)}{N}$, where N is a positive constant. When $t = 0$, $y = \frac{N}{4}$.
- Find y in terms of t and find $\frac{dy}{dt}$ in terms of t .
 - What limiting value does the population size approach for large values of t ?
 - Explain why the population is always increasing.
 - What is the population when the population is increasing most rapidly?
 - For $N = 10^6$:
 - Sketch the graph of $\frac{dy}{dt}$ against y .
 - At what time is the population increasing most rapidly?
- 20** An object projected vertically upwards from the surface of the Earth experiences an acceleration of a m/s² at a point x m from the centre of the Earth (neglecting air resistance). This acceleration is given by $a = \frac{-gR^2}{x^2}$, where g m/s² is the acceleration due to gravity and R m is the radius length of the Earth.
- Given that $g = 9.8$, $R = 6.4 \times 10^6$ and the object has an upwards velocity of u m/s at the Earth's surface:
 - Express v^2 in terms of x , using $a = \frac{d}{dx} \left(\frac{1}{2} v^2 \right)$.
 - Use the result of part **i** to find the position of the object when it has zero velocity.
 - For what value of u does the result in part **ii** not exist?
 - The minimum value of u for which the object does not fall back to Earth is called the escape velocity. Determine the escape velocity in km/h.
- 21** Define $f(x) = \frac{e^x - e^{-x}}{e^x + e^{-x}}$.
- Find $f(0)$.
 - Find $\lim_{x \rightarrow \infty} f(x)$.
 - Find $\lim_{x \rightarrow -\infty} f(x)$.
 - Find $f'(x)$.
 - Sketch the graph of f .
 - Find $f^{-1}(x)$.
 - If $g(x) = f^{-1}(x)$, find $g'(x)$.
 - Sketch the graph of g' and prove that the area measure of the region bounded by the graph of $y = g'(x)$, the x -axis, the y -axis and the line $x = \frac{1}{2}$ is $\ln(\sqrt{3})$.

- 22** The diagram shows a plane circular section through O , the centre of the Earth (which is assumed to be stationary for the purpose of this problem).

From the point A on the surface, a rocket is launched vertically upwards. After t hours, the rocket is at B , which is h km above A . Point C is on the horizon as seen from B , and the length of the chord AC is y km. The angle AOC is θ radians. The radius of the Earth is r km.

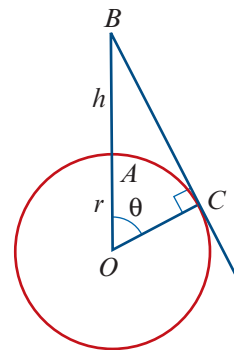

- a**
- Express y in terms of r and θ .
 - Express $\cos \theta$ in terms of r and h .
- b** Suppose that after t hours the vertical velocity of the rocket is $\frac{dh}{dt} = r \sin t$, $t \in [0, \pi)$. Assume that $r = 6000$.
- Find $\frac{dy}{d\theta}$ and $\frac{dy}{dt}$.
 - How high is the rocket when $t = \frac{\pi}{2}$?
 - Find $\frac{dy}{dt}$ when $t = \frac{\pi}{2}$.
- 23** **a** Differentiate $f(x) = e^{-x}x^n$ and hence prove that

$$\int e^{-x}x^n dx = n \int e^{-x}x^{n-1} dx - e^{-x}x^n$$

- b** Let $g: \mathbb{R}^+ \rightarrow \mathbb{R}$, $g(n) = \int_0^\infty e^{-x}x^n dx$.

Note: $\int_a^\infty f(x) dx = \lim_{b \rightarrow \infty} \int_a^b f(x) dx$

- Show that $g(0) = 1$.
 - Using the answer to **a**, show that $g(n) = ng(n-1)$.
 - Using your answers to **b i** and **b ii**, show that $g(n) = n!$, for $n = 0, 1, 2, 3, \dots$
- 24** A large weather balloon is in the shape of a hemisphere on a cone, as shown in this diagram. When inflated, the height of the cone is twice the radius length of the hemisphere. The shapes and conditions are true as long as the radius of the hemisphere is at least 2 metres.
- At time t minutes, the radius length of the hemisphere is r metres and the volume of the balloon is V m³, for $r \geq 2$.
- The balloon has been inflated so that the radius length is 10 m and it is ready to be released, when a leak develops. The gas leaks out at the rate of t^2 m³ per minute.
- Find the relationship between V and r .
 - Construct a differential equation of the form $f(r) \frac{dr}{dt} = g(t)$.
 - Solve the differential equation with respect to t , given that the initial radius length is 10 m.
 - Find how long it will take for the radius length to reduce to 2 metres.

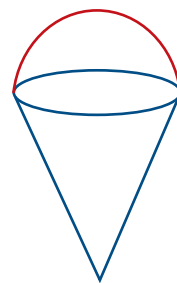

16

Vector functions

Objectives

- ▶ To sketch the graphs of curves in the plane specified by **vector functions**.
- ▶ To understand the concept of **position vectors** as a function of time.
- ▶ To represent the path of a particle moving in two dimensions as a **vector function**.
- ▶ To differentiate and antidifferentiate vector functions.
- ▶ To use **vector calculus** to analyse the motion of a particle along a curve, by finding the velocity, acceleration and speed.
- ▶ To investigate **projectile motion** and **circular motion**.

In Chapter 5, we introduced vectors and applied them to physical and geometric situations.

In Chapter 14, we studied motion in a straight line and used the vector quantities of position, displacement, velocity and acceleration to describe this motion. In this chapter, we consider motion in two dimensions and we again employ vectors.

The motion of a particle in space can be described by giving its position vector with respect to an origin in terms of a variable t . The variable in this situation is referred to as a **parameter**. This idea has been used in Section 1E, where parametric equations were introduced to describe circles, ellipses and hyperbolas, and also in Chapter 6, where vector equations were introduced to describe straight lines. Differentiation involving parametric equations was used in Chapter 10.

In two dimensions, the position vector can be described through the use of two functions. The position vector at time t is given by

$$\mathbf{r}(t) = x(t)\mathbf{i} + y(t)\mathbf{j}$$

We say that $\mathbf{r}(t)$ is a **vector function**.

16A Vector functions

► Describing a particle's path using a vector function



Consider the vector $\mathbf{r} = (3 + t)\mathbf{i} + (1 - 2t)\mathbf{j}$, where $t \in \mathbb{R}$.

Then \mathbf{r} represents a family of vectors defined by different values of t .

If the variable t represents time, then \mathbf{r} is a vector function of time. We write

$$\mathbf{r}(t) = (3 + t)\mathbf{i} + (1 - 2t)\mathbf{j}, \quad t \in \mathbb{R}$$

Further, if $\mathbf{r}(t)$ represents the position of a particle with respect to time, then the graph of the endpoints of $\mathbf{r}(t)$ will represent the path of the particle in the Cartesian plane.

A table of values for a range of values of t is given below. These position vectors can be represented in the Cartesian plane as shown in Figure A.

t	-3	-2	-1	0	1	2	3
$\mathbf{r}(t)$	$7\mathbf{j}$	$\mathbf{i} + 5\mathbf{j}$	$2\mathbf{i} + 3\mathbf{j}$	$3\mathbf{i} + \mathbf{j}$	$4\mathbf{i} - \mathbf{j}$	$5\mathbf{i} - 3\mathbf{j}$	$6\mathbf{i} - 5\mathbf{j}$

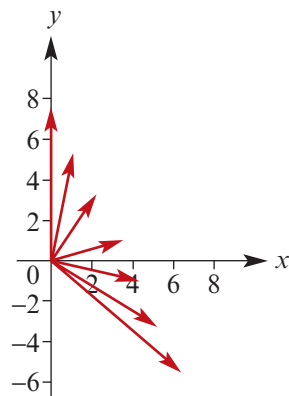

Figure A

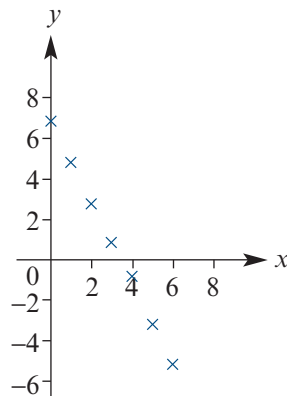

Figure B

The graph of the position vectors (Figure A) is not helpful. But when only the endpoints are plotted (Figure B), the pattern of the path is more obvious. We can find the Cartesian equation for the path as follows.

Let (x, y) be the point on the path at time t .

Then $\mathbf{r}(t) = x\mathbf{i} + y\mathbf{j}$ and therefore

$$x\mathbf{i} + y\mathbf{j} = (3 + t)\mathbf{i} + (1 - 2t)\mathbf{j}$$

This implies that

$$x = 3 + t \quad (1) \quad \text{and} \quad y = 1 - 2t \quad (2)$$

Now we eliminate the parameter t from the equations.

From (1), we have $t = x - 3$. Substituting in (2) gives $y = 1 - 2(x - 3) = 7 - 2x$.

The particle's path is the straight line with equation $y = 7 - 2x$.

► Describing curves in the plane using vector functions

Now consider the Cartesian equation $y = x^2$. The graph can also be described by a vector function using a parameter t , which does not necessarily represent time.

Define the vector function $\mathbf{r}(t) = t\mathbf{i} + t^2\mathbf{j}$, $t \in \mathbb{R}$.

Using similar reasoning as before, if $x\mathbf{i} + y\mathbf{j} = t\mathbf{i} + t^2\mathbf{j}$, then $x = t$ and $y = t^2$, so eliminating t yields $y = x^2$.

This representation is not unique. It is clear that $\mathbf{r}(t) = t^3\mathbf{i} + t^6\mathbf{j}$, $t \in \mathbb{R}$, also represents the graph with Cartesian equation $y = x^2$. Note that if these two vector functions are used to describe the motion of particles, then the paths are the same, but the particles are at different locations at a given time (with the exception of $t = 0$ and $t = 1$).

Also note that $\mathbf{r}(t) = t^2\mathbf{i} + t^4\mathbf{j}$, $t \in \mathbb{R}$, only represents the equation $y = x^2$ for $x \geq 0$.

In the rest of this section, we consider graphs defined by vector functions, but without relating them to the motion of a particle. We view a vector function as a mapping from a subset of the real numbers into the set of all two-dimensional vectors.

Example 1

Find the Cartesian equation for the graph represented by each vector function:

a $\mathbf{r}(t) = (2 - t)\mathbf{i} + (3 + t^2)\mathbf{j}$, $t \in \mathbb{R}$

b $\mathbf{r}(t) = (1 - \cos t)\mathbf{i} + \sin t\mathbf{j}$, $t \in \mathbb{R}$

Solution

a Let (x, y) be any point on the curve.

Then $x = 2 - t$ (1)

and $y = 3 + t^2$ (2)

Equation (1) gives $t = 2 - x$.

Substitute in (2):

$$y = 3 + (2 - x)^2$$

$$\therefore y = x^2 - 4x + 7, \quad x \in \mathbb{R}$$

b Let (x, y) be any point on the curve.

Then $x = 1 - \cos t$ (3)

and $y = \sin t$ (4)

From (3): $\cos t = 1 - x$.

From (4):

$$y^2 = \sin^2 t = 1 - \cos^2 t$$

$$= 1 - (1 - x)^2$$

$$= -x^2 + 2x$$

The Cartesian equation is $y^2 = -x^2 + 2x$.

For a vector function $\mathbf{r}(t) = x(t)\mathbf{i} + y(t)\mathbf{j}$:

- The **domain** of the Cartesian relation is given by the range of the function $x(t)$.
- The **range** of the Cartesian relation is given by the range of the function $y(t)$.

In Example 1b, the domain of the corresponding Cartesian relation is the range of the function $x(t) = 1 - \cos t$, which is $[0, 2]$. The range of the Cartesian relation is the range of the function $y(t) = \sin t$, which is $[-1, 1]$.

Note that the Cartesian equation $y^2 = -x^2 + 2x$ can be written as $(x - 1)^2 + y^2 = 1$; it is the circle with centre $(1, 0)$ and radius 1.

Example 2

Find the Cartesian equation of each of the following. State the domain and range and sketch the graph of each of the relations.

a $r(t) = \cos^2(t)\mathbf{i} + \sin^2(t)\mathbf{j}, \quad t \in \mathbb{R}$

b $r(t) = t\mathbf{i} + (1-t)\mathbf{j}, \quad t \in \mathbb{R}$

Solution

a Let (x, y) be any point on the curve defined by $r(t) = \cos^2(t)\mathbf{i} + \sin^2(t)\mathbf{j}, t \in \mathbb{R}$. Then

$$x = \cos^2(t) \quad \text{and} \quad y = \sin^2(t)$$

Therefore

$$y = \sin^2(t) = 1 - \cos^2(t) = 1 - x$$

Hence $y = 1 - x$.

Note that $0 \leq \cos^2(t) \leq 1$ and $0 \leq \sin^2(t) \leq 1$, for all $t \in \mathbb{R}$. The domain of the relation is $[0, 1]$ and the range is $[0, 1]$.

b Let (x, y) be any point on the curve defined by $r(t) = t\mathbf{i} + (1-t)\mathbf{j}, t \in \mathbb{R}$. Then

$$x = t \quad \text{and} \quad y = 1 - t$$

Hence $y = 1 - x$.

The domain is \mathbb{R} and the range is \mathbb{R} .

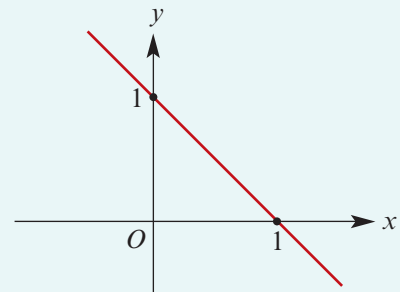
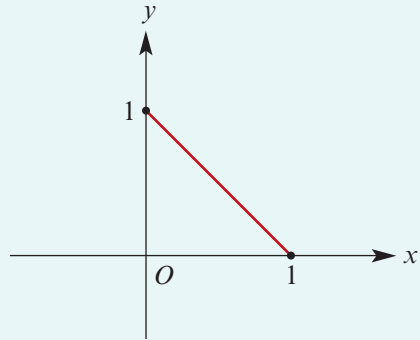

Example 3

For each of the following, state the Cartesian equation, the domain and range of the corresponding Cartesian relation and sketch the graph:

a $r(\lambda) = (1 - 2\cos(\lambda))\mathbf{i} + 3\sin(\lambda)\mathbf{j}$

b $r(\lambda) = 2\sec(\lambda)\mathbf{i} + \tan(\lambda)\mathbf{j}$

Solution

a Let $x = 1 - 2\cos(\lambda)$ and $y = 3\sin(\lambda)$. Then

$$\frac{x-1}{-2} = \cos(\lambda) \quad \text{and} \quad \frac{y}{3} = \sin(\lambda)$$

Squaring each and adding yields

$$\frac{(x-1)^2}{4} + \frac{y^2}{9} = \cos^2(\lambda) + \sin^2(\lambda) = 1$$

The graph is an ellipse with centre $(1, 0)$.

The domain of the relation is $[-1, 3]$ and the range is $[-3, 3]$.

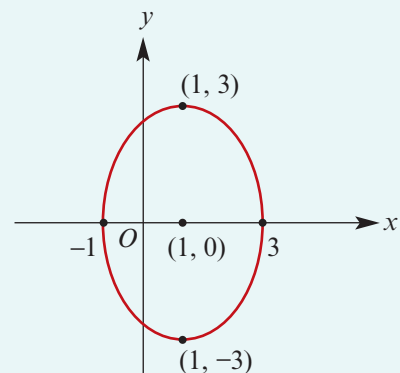

Note: The entire ellipse is obtained by taking $\lambda \in [0, 2\pi]$.



$$\mathbf{b} \quad \mathbf{r}(\lambda) = 2 \sec(\lambda) \mathbf{i} + \tan(\lambda) \mathbf{j}, \text{ for } \lambda \in \mathbb{R} \setminus \left\{ \frac{(2n+1)\pi}{2} : n \in \mathbb{Z} \right\}$$

Let (x, y) be any point on the curve. Then

$$x = 2 \sec(\lambda) \quad \text{and} \quad y = \tan(\lambda)$$

$$\therefore x^2 = 4 \sec^2(\lambda) \quad \text{and} \quad y^2 = \tan^2(\lambda)$$

$$\therefore \frac{x^2}{4} = \sec^2(\lambda) \quad \text{and} \quad y^2 = \tan^2(\lambda)$$

But $\sec^2(\lambda) - \tan^2(\lambda) = 1$ and therefore

$$\frac{x^2}{4} - y^2 = 1$$

The domain of the relation is the range of $x(\lambda) = 2 \sec(\lambda)$, which is $(-\infty, -2] \cup [2, \infty)$.

The range of the relation is the range of $y(\lambda) = \tan(\lambda)$, which is \mathbb{R} .

The graph is a hyperbola centred at the origin with asymptotes

$$y = \pm \frac{x}{2}.$$

Note: The graph is produced for $\lambda \in \left(-\frac{\pi}{2}, \frac{\pi}{2}\right) \cup \left(\frac{\pi}{2}, \frac{3\pi}{2}\right)$.

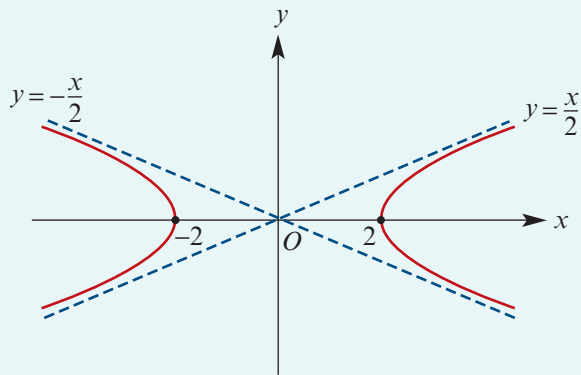

Exercise 16A

Example 1, 2 **1** For each of the following vector functions, find the corresponding Cartesian equation, and state the domain and range of the Cartesian relation:

a $\mathbf{r}(t) = t\mathbf{i} + 2t\mathbf{j}, \quad t \in \mathbb{R}$

b $\mathbf{r}(t) = 2\mathbf{i} + 5t\mathbf{j}, \quad t \in \mathbb{R}$

c $\mathbf{r}(t) = -t\mathbf{i} + 7\mathbf{j}, \quad t \in \mathbb{R}$

d $\mathbf{r}(t) = (2-t)\mathbf{i} + (t+7)\mathbf{j}, \quad t \in \mathbb{R}$

e $\mathbf{r}(t) = t^2\mathbf{i} + (2-3t)\mathbf{j}, \quad t \in \mathbb{R}$

f $\mathbf{r}(t) = (t-3)\mathbf{i} + (t^3+1)\mathbf{j}, \quad t \in \mathbb{R}$

g $\mathbf{r}(t) = (2t+1)\mathbf{i} + 3t\mathbf{j}, \quad t \in \mathbb{R}$

h $\mathbf{r}(t) = \left(t - \frac{\pi}{2}\right)\mathbf{i} + \cos(2t)\mathbf{j}, \quad t \in \mathbb{R}$

i $\mathbf{r}(t) = \frac{1}{t+4}\mathbf{i} + (t^2+1)\mathbf{j}, \quad t \neq -4$

j $\mathbf{r}(t) = \frac{1}{t}\mathbf{i} + \frac{1}{t+1}\mathbf{j}, \quad t \neq 0, -1$

Example 3 **2** For each of the following vector functions, find the corresponding Cartesian relation, state the domain and range of the relation and sketch the graph:

a $\mathbf{r}(t) = 2 \cos(t) \mathbf{i} + 3 \sin(t) \mathbf{j}, \quad t \in \mathbb{R}$

b $\mathbf{r}(t) = 2 \cos^2(t) \mathbf{i} + 3 \sin^2(t) \mathbf{j}, \quad t \in \mathbb{R}$

c $\mathbf{r}(t) = t\mathbf{i} + 3t^2\mathbf{j}, \quad t \geq 0$

d $\mathbf{r}(t) = t^3\mathbf{i} + 3t^2\mathbf{j}, \quad t \geq 0$

e $\mathbf{r}(\lambda) = \cos(\lambda) \mathbf{i} + \sin(\lambda) \mathbf{j}, \quad \lambda \in \left[0, \frac{\pi}{2}\right]$

$$\mathbf{f} \quad \mathbf{r}(\lambda) = 3 \sec(\lambda) \mathbf{i} + 2 \tan(\lambda) \mathbf{j}, \quad \lambda \in \left(0, \frac{\pi}{2}\right)$$

$$\mathbf{g} \quad \mathbf{r}(t) = 4 \cos(2t) \mathbf{i} + 4 \sin(2t) \mathbf{j}, \quad t \in \left[0, \frac{\pi}{2}\right]$$

$$\mathbf{h} \quad \mathbf{r}(\lambda) = 3 \sec^2(\lambda) \mathbf{i} + 2 \tan^2(\lambda) \mathbf{j}, \quad \lambda \in \left(-\frac{\pi}{2}, \frac{\pi}{2}\right)$$

$$\mathbf{i} \quad \mathbf{r}(t) = (3 - t)\mathbf{i} + (5t^2 + 6t)\mathbf{j}, \quad t \in \mathbb{R}$$

- 3** Find a vector function which corresponds to each of the following. Note that the answers given are the ‘natural choice’, but your answers could be different.

$$\mathbf{a} \quad y = 3 - 2x$$

$$\mathbf{b} \quad x^2 + y^2 = 4$$

$$\mathbf{c} \quad (x - 1)^2 + y^2 = 4$$

$$\mathbf{d} \quad x^2 - y^2 = 4$$

$$\mathbf{e} \quad y = (x - 3)^2 + 2(x - 3)$$

$$\mathbf{f} \quad 2x^2 + 3y^2 = 12$$

- 4** A circle of radius 5 has its centre at the point C with position vector $2\mathbf{i} + 6\mathbf{j}$ relative to the origin O . A general point P on the circle has position \mathbf{r} relative to O . The angle between \mathbf{i} and \overrightarrow{CP} , measured anticlockwise from \mathbf{i} to \overrightarrow{CP} , is denoted by θ .

a Give the vector function for P .

b Give the Cartesian equation for P .



16B Position vectors as a function of time

Consider a particle travelling at a constant speed along a circular path with radius length 1 unit and centre O . The path is represented in **Cartesian form** as

$$\{(x, y) : x^2 + y^2 = 1\}$$

If the particle starts at the point $(1, 0)$ and travels anticlockwise, taking 2π units of time to complete one circle, then its path is represented in **parametric form** as

$$\{(x, y) : x = \cos t \text{ and } y = \sin t, \text{ for } t \geq 0\}$$

This is expressed in vector form as

$$\mathbf{r}(t) = \cos t \mathbf{i} + \sin t \mathbf{j}$$

where $\mathbf{r}(t)$ is the position vector of the particle at time t .

The graph of a vector function is the set of points determined by the function $\mathbf{r}(t)$ as t varies.

In two dimensions, the x - and y -axes are used.

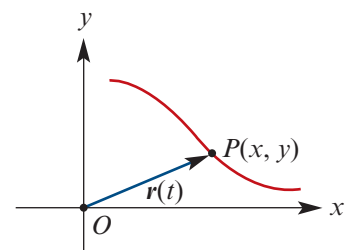

In three dimensions, three mutually perpendicular axes are used. It is best to consider the x - and y -axes as in the horizontal plane and the z -axis as vertical and through the point of intersection of the x - and y -axes.

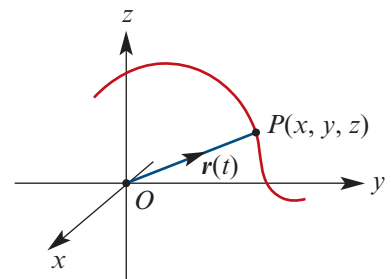

Information from the vector function

The vector function gives much more information about the motion of the particle than the Cartesian equation of its path.

For example, the vector function $\mathbf{r}(t) = \cos t \mathbf{i} + \sin t \mathbf{j}$, $t \geq 0$, indicates that:

- At time $t = 0$, the particle has position vector $\mathbf{r}(0) = \mathbf{i}$. That is, the particle starts at $(1, 0)$.
- The particle moves with constant speed on the curve with equation $x^2 + y^2 = 1$.
- The particle moves in an anticlockwise direction.
- The particle moves around the circle with a period of 2π , i.e. it takes 2π units of time to complete one circle.

The vector function $\mathbf{r}(t) = \cos(2\pi t) \mathbf{i} + \sin(2\pi t) \mathbf{j}$ describes a particle moving anticlockwise around the circle with equation $x^2 + y^2 = 1$, but this time the period is 1 unit of time.

The vector function $\mathbf{r}(t) = -\cos(2\pi t) \mathbf{i} + \sin(2\pi t) \mathbf{j}$ again describes a particle moving around the unit circle, but the particle starts at $(-1, 0)$ and moves clockwise.

Example 4

Sketch the path of a particle where the position at time t is given by

$$\mathbf{r}(t) = 2t \mathbf{i} + t^2 \mathbf{j}, \quad t \geq 0$$

Solution

Now $x = 2t$ and $y = t^2$.

This implies $t = \frac{x}{2}$ and so $y = \left(\frac{x}{2}\right)^2$.

The Cartesian form is $y = \frac{x^2}{4}$, for $x \geq 0$.

Since $\mathbf{r}(0) = \mathbf{0}$ and $\mathbf{r}(1) = 2\mathbf{i} + \mathbf{j}$, it can be seen that the particle starts at the origin and moves along the parabola $y = \frac{x^2}{4}$ with $x \geq 0$.

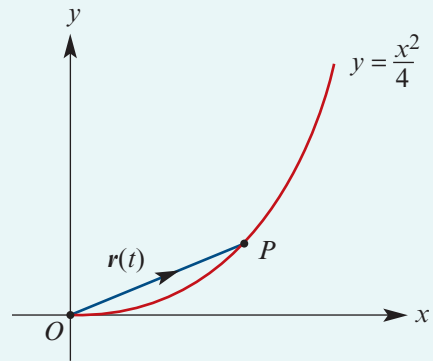

Notes:

- The equation $\mathbf{r}(t) = t \mathbf{i} + \frac{1}{4}t^2 \mathbf{j}$, $t \geq 0$, gives the same Cartesian path, but the rate at which the particle moves along the path is different.
- If $\mathbf{r}(t) = -t \mathbf{i} + \frac{1}{4}t^2 \mathbf{j}$, $t \geq 0$, then again the Cartesian equation is $y = \frac{x^2}{4}$, but $x \leq 0$. Hence the motion is along the curve shown and in the direction indicated.

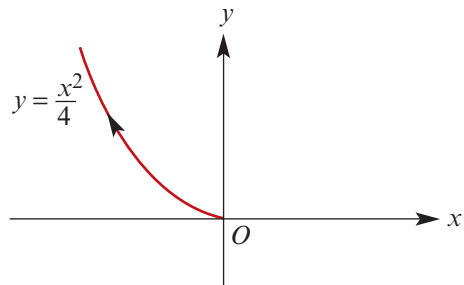

■ Motion in two dimensions

When a particle moves along a curve in a plane, its position is specified by a vector function of the form

$$\mathbf{r}(t) = x(t)\mathbf{i} + y(t)\mathbf{j}$$

■ Motion in three dimensions

When a particle moves along a curve in three-dimensional space, its position is specified by a vector function of the form

$$\mathbf{r}(t) = x(t)\mathbf{i} + y(t)\mathbf{j} + z(t)\mathbf{k}$$

Example 5

An object moves along a path where the position vector is given by

$$\mathbf{r}(t) = \cos t \mathbf{i} + \sin t \mathbf{j} + 2\mathbf{k}, \quad t \geq 0$$

Describe the motion of the object.

Solution

Being unfamiliar with the graphs of relations in three dimensions, it is probably best to determine a number of position vectors (points) and try to visualise joining the dots.

t	$\mathbf{r}(t)$	Point
0	$\mathbf{i} + 2\mathbf{k}$	(1, 0, 2)
$\frac{\pi}{2}$	$\mathbf{j} + 2\mathbf{k}$	(0, 1, 2)
π	$-\mathbf{i} + 2\mathbf{k}$	(-1, 0, 2)
$\frac{3\pi}{2}$	$-\mathbf{j} + 2\mathbf{k}$	(0, -1, 2)
2π	$\mathbf{i} + 2\mathbf{k}$	(1, 0, 2)

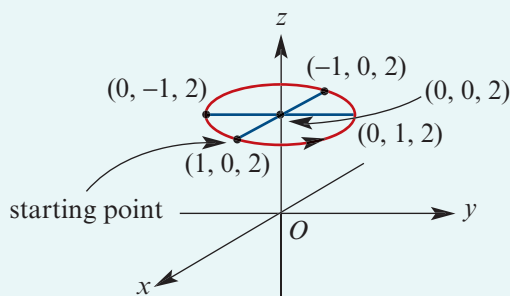

The object is moving along a circular path, with centre (0, 0, 2) and radius length 1, starting at (1, 0, 2) and moving anticlockwise when viewed from above, always at a distance of 2 above the x - y plane (horizontal plane).



Example 6

The motion of two particles is given by the vector functions $\mathbf{r}_1(t) = (2t - 3)\mathbf{i} + (t^2 + 10)\mathbf{j}$ and $\mathbf{r}_2(t) = (t + 2)\mathbf{i} + 7t\mathbf{j}$, where $t \geq 0$. Find:

- the point at which the particles collide
- the points at which the two paths cross
- the distance between the particles when $t = 1$.

Solution

- a** The two particles collide when they share the same position at the same time:

$$\mathbf{r}_1(t) = \mathbf{r}_2(t)$$

$$(2t - 3)\mathbf{i} + (t^2 + 10)\mathbf{j} = (t + 2)\mathbf{i} + 7t\mathbf{j}$$

Therefore

$$2t - 3 = t + 2 \quad (1) \quad \text{and} \quad t^2 + 10 = 7t \quad (2)$$

From (1), we have $t = 5$.

Check in (2): $t^2 + 10 = 35 = 7t$.

The particles are at the same point when $t = 5$, i.e. they collide at the point $(7, 35)$.

- b** At the points where the paths cross, the two paths share common points which may occur at different times for each particle. Therefore we need to distinguish between the two time variables:

$$\mathbf{r}_1(t) = (2t - 3)\mathbf{i} + (t^2 + 10)\mathbf{j}$$

$$\mathbf{r}_2(s) = (s + 2)\mathbf{i} + 7s\mathbf{j}$$

When the paths cross:

$$2t - 3 = s + 2 \quad (3)$$

$$t^2 + 10 = 7s \quad (4)$$

We now solve these equations simultaneously.

Equation (3) becomes $s = 2t - 5$.

Substitute in (4):

$$t^2 + 10 = 7(2t - 5)$$

$$t^2 - 14t + 45 = 0$$

$$(t - 9)(t - 5) = 0$$

$$\therefore t = 5 \text{ or } t = 9$$

The corresponding values for s are 5 and 13.

These values can be substituted back into the vector equations to obtain the points at which the paths cross, i.e. $(7, 35)$ and $(15, 91)$.

c When $t = 1$: $r_1(1) = -i + 11j$

$$r_2(1) = 3i + 7j$$

The vector representing the displacement between the two particles after 1 second is

$$r_1(1) - r_2(1) = -4i + 4j$$

The distance between the two particles is $\sqrt{(-4)^2 + 4^2} = 4\sqrt{2}$ units.

Exercise 16B

Example 4

1 The path of a particle with respect to an origin is described as a function of time, t , by the vector equation $r(t) = \cos t i + \sin t j$, $t \geq 0$.

- Find the Cartesian equation of the path.
- Sketch the path of the particle.
- Find the times at which the particle crosses the y -axis.

2 Repeat Question 1 for the paths described by the following vector functions:

a $r(t) = (t^2 - 9)i + 8tj$, $t \geq 0$ **b** $r(t) = (t + 1)i + \frac{1}{t + 2}j$, $t > -2$

c $r(t) = \frac{t - 1}{t + 1}i + \frac{2}{t + 1}j$, $t > -1$

Example 6

3 The paths of two particles with respect to time t are described by the vector equations $r_1(t) = (3t - 5)i + (8 - t^2)j$ and $r_2(t) = (3 - t)i + 2tj$, where $t \geq 0$. Find:

- the point at which the two particles collide
- the points at which the two paths cross
- the distance between the two particles when $t = 3$.

4 Repeat Question 3 for the paths described by the vector equations $r_1(t) = (2t^2 + 4)i + (t - 2)j$ and $r_2(t) = 9ti + 3(t - 1)j$, where $t \geq 0$.

5 The path of a particle defined as a function of time t is given by the vector equation $r(t) = (1 + t)i + (3t + 2)j$. Find:

- the distance of the particle from the origin when $t = 3$
- the times at which the distance of the particle from the origin is 1 unit.

6 Let $r(t) = ti + 2tj - 3k$ be the vector equation representing the motion of a particle with respect to time t , where $t \geq 0$. Find:

- the position, A , of the particle when $t = 3$
- the distance of the particle from the origin when $t = 3$
- the position, B , of the particle when $t = 4$
- the displacement of the particle in the fourth second in vector form.

- 7** Let $\mathbf{r}(t) = (t + 1)\mathbf{i} + (3 - t)\mathbf{j} + 2t\mathbf{k}$ be the vector equation representing the motion of a particle with respect to time t , where $t \geq 0$. Find:
- the position of the particle when $t = 2$
 - the distance of the particle from the point $(4, -1, 1)$ when $t = 2$.
- 8** Let $\mathbf{r}(t) = at^2\mathbf{i} + (b - t)\mathbf{j}$ be the vector equation representing the motion of a particle with respect to time t . When $t = 3$, the position of the particle is $(6, 4)$. Find a and b .
- 9** A particle travels in a path such that the position vector, $\mathbf{r}(t)$, at time t is given by $\mathbf{r}(t) = 3 \cos(t)\mathbf{i} + 2 \sin(t)\mathbf{j}$, $t \geq 0$.
- Express this vector function as a Cartesian relation.
 - Find the initial position of the particle.
 - The positive y -axis points north and the positive x -axis points east. Find, correct to two decimal places, the bearing of the point P , the position of the particle at $t = \frac{3\pi}{4}$, from:
 - the origin
 - the initial position.
- 10** An object moves so that the position vector at time t is given by $\mathbf{r}(t) = e^t\mathbf{i} + e^{-t}\mathbf{j}$, $t \geq 0$.
- Express this vector function as a Cartesian relation.
 - Find the initial position of the object.
 - Sketch the graph of the path travelled by the object, indicating the direction of motion.
- 11** An object is moving so that its position, \mathbf{r} , at time t is given by $\mathbf{r}(t) = (e^t + e^{-t})\mathbf{i} + (e^t - e^{-t})\mathbf{j}$, $t \geq 0$.
- Find the initial position of the object.
 - Find the position at $t = \ln 2$.
 - Find the Cartesian equation of the path.
- 12** An object is projected so that its position, \mathbf{r} , at time t is given by $\mathbf{r}(t) = 100t\mathbf{i} + (100\sqrt{3}t - 5t^2)\mathbf{j}$, for $0 \leq t \leq 20\sqrt{3}$.
- Find the initial and final positions of the object.
 - Find the Cartesian form of the path.
 - Sketch the graph of the path, indicating the direction of motion.
- 13** Two particles A and B have position vectors $\mathbf{r}_A(t)$ and $\mathbf{r}_B(t)$ respectively at time t , given by $\mathbf{r}_A(t) = 6t^2\mathbf{i} + (2t^3 - 18t)\mathbf{j}$ and $\mathbf{r}_B(t) = (13t - 6)\mathbf{i} + (3t^2 - 27)\mathbf{j}$, where $t \geq 0$. Find where and when the particles collide.

Example 5

- 14** The motion of a particle is described by the vector equation $\mathbf{r}(t) = 3 \cos t\mathbf{i} + 3 \sin t\mathbf{j} + \mathbf{k}$, $t \geq 0$. Describe the motion of the particle.
- 15** The motion of a particle is described by the vector equation $\mathbf{r}(t) = t\mathbf{i} + 3t\mathbf{j} + t\mathbf{k}$, $t \geq 0$. Describe the motion of the particle.

- 16** The motion of a particle is described by the vector equation $\mathbf{r}(t) = (1 - 2 \cos(2t))\mathbf{i} + (3 - 5 \sin(2t))\mathbf{j}$, for $t \geq 0$. Find:
- the Cartesian equation of the path
 - the position at:
 - $t = 0$
 - $t = \frac{\pi}{4}$
 - $t = \frac{\pi}{2}$
 - the time taken by the particle to return to its initial position
 - the direction of motion along the curve.
- 17** For each of the following vector equations:
- find the Cartesian equation of the body's path
 - sketch the path
 - describe the motion of the body.
- $\mathbf{r}(t) = \cos^2(3\pi t)\mathbf{i} + 2 \cos^2(3\pi t)\mathbf{j}$, $t \geq 0$
 - $\mathbf{r}(t) = \cos(2\pi t)\mathbf{i} + \cos(4\pi t)\mathbf{j}$, $t \geq 0$
 - $\mathbf{r}(t) = e^t\mathbf{i} + e^{-2t}\mathbf{j}$, $t \geq 0$



16C Vector calculus

Consider the curve defined by $\mathbf{r}(t)$.

Let P and Q be points on the curve with position vectors $\mathbf{r}(t)$ and $\mathbf{r}(t+h)$ respectively.

Then $\overrightarrow{PQ} = \mathbf{r}(t+h) - \mathbf{r}(t)$.

It follows that

$$\frac{1}{h}(\mathbf{r}(t+h) - \mathbf{r}(t))$$

is a vector parallel to \overrightarrow{PQ} .

As $h \rightarrow 0$, the point Q approaches P along the curve.

The derivative of \mathbf{r} with respect to t is denoted by $\dot{\mathbf{r}}$ and is defined by

$$\dot{\mathbf{r}}(t) = \lim_{h \rightarrow 0} \frac{\mathbf{r}(t+h) - \mathbf{r}(t)}{h}$$

provided that this limit exists.

The vector $\dot{\mathbf{r}}(t)$ points along the tangent to the curve at P , in the direction of increasing t .

Note: The derivative of a vector function $\mathbf{r}(t)$ is also

denoted by $\frac{d\mathbf{r}}{dt}$ or $\mathbf{r}'(t)$.

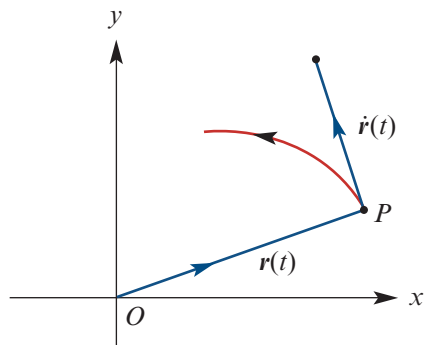
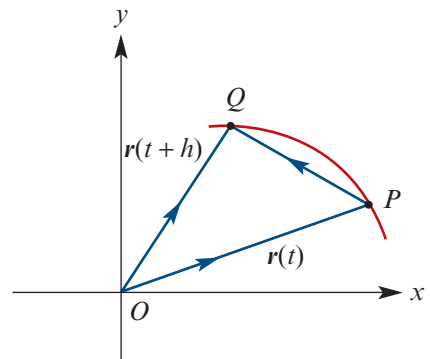

Derivative of a vector function

Let $\mathbf{r}(t) = x(t)\mathbf{i} + y(t)\mathbf{j}$. If both $x(t)$ and $y(t)$ are differentiable, then

$$\dot{\mathbf{r}}(t) = \dot{x}(t)\mathbf{i} + \dot{y}(t)\mathbf{j}$$

Proof By the definition, we have

$$\begin{aligned}\dot{\mathbf{r}}(t) &= \lim_{h \rightarrow 0} \frac{\mathbf{r}(t+h) - \mathbf{r}(t)}{h} \\ &= \lim_{h \rightarrow 0} \frac{(x(t+h)\mathbf{i} + y(t+h)\mathbf{j}) - (x(t)\mathbf{i} + y(t)\mathbf{j})}{h} \\ &= \lim_{h \rightarrow 0} \frac{x(t+h)\mathbf{i} - x(t)\mathbf{i}}{h} + \lim_{h \rightarrow 0} \frac{y(t+h)\mathbf{j} - y(t)\mathbf{j}}{h} \\ &= \left(\lim_{h \rightarrow 0} \frac{x(t+h) - x(t)}{h} \right) \mathbf{i} + \left(\lim_{h \rightarrow 0} \frac{y(t+h) - y(t)}{h} \right) \mathbf{j} \\ \therefore \dot{\mathbf{r}}(t) &= \frac{dx}{dt} \mathbf{i} + \frac{dy}{dt} \mathbf{j}\end{aligned}$$

The second derivative of $\mathbf{r}(t)$ is

$$\ddot{\mathbf{r}}(t) = \frac{d^2x}{dt^2} \mathbf{i} + \frac{d^2y}{dt^2} \mathbf{j} = \ddot{x}(t)\mathbf{i} + \ddot{y}(t)\mathbf{j}$$

This can be extended to three-dimensional vector functions:

$$\begin{aligned}\mathbf{r}(t) &= x(t)\mathbf{i} + y(t)\mathbf{j} + z(t)\mathbf{k} \\ \dot{\mathbf{r}}(t) &= \frac{dx}{dt} \mathbf{i} + \frac{dy}{dt} \mathbf{j} + \frac{dz}{dt} \mathbf{k} \\ \ddot{\mathbf{r}}(t) &= \frac{d^2x}{dt^2} \mathbf{i} + \frac{d^2y}{dt^2} \mathbf{j} + \frac{d^2z}{dt^2} \mathbf{k}\end{aligned}$$

Example 7

Find $\dot{\mathbf{r}}(t)$ and $\ddot{\mathbf{r}}(t)$ if $\mathbf{r}(t) = 20t\mathbf{i} + (15t - 5t^2)\mathbf{j}$.

Solution

$$\dot{\mathbf{r}}(t) = 20\mathbf{i} + (15 - 10t)\mathbf{j}$$

$$\ddot{\mathbf{r}}(t) = -10\mathbf{j}$$

Example 8

Find $\dot{\mathbf{r}}(t)$ and $\ddot{\mathbf{r}}(t)$ if $\mathbf{r}(t) = \cos t\mathbf{i} - \sin t\mathbf{j} + 5t\mathbf{k}$.

Solution

$$\dot{\mathbf{r}}(t) = -\sin t\mathbf{i} - \cos t\mathbf{j} + 5\mathbf{k}$$

$$\ddot{\mathbf{r}}(t) = -\cos t\mathbf{i} + \sin t\mathbf{j}$$

Example 9

If $\mathbf{r}(t) = t\mathbf{i} + ((t-1)^3 + 1)\mathbf{j}$, find $\dot{\mathbf{r}}(\alpha)$ and $\ddot{\mathbf{r}}(\alpha)$, where $\mathbf{r}(\alpha) = \mathbf{i} + \mathbf{j}$.

Solution

$$\mathbf{r}(t) = t\mathbf{i} + ((t-1)^3 + 1)\mathbf{j}$$

$$\dot{\mathbf{r}}(t) = \mathbf{i} + 3(t-1)^2\mathbf{j}$$

$$\ddot{\mathbf{r}}(t) = 6(t-1)\mathbf{j}$$

We have

$$\mathbf{r}(\alpha) = \alpha\mathbf{i} + ((\alpha-1)^3 + 1)\mathbf{j} = \mathbf{i} + \mathbf{j}$$

Therefore $\alpha = 1$, and $\dot{\mathbf{r}}(1) = \mathbf{i}$ and $\ddot{\mathbf{r}}(1) = \mathbf{0}$.

Example 10

If $\mathbf{r}(t) = e^t\mathbf{i} + ((e^t - 1)^3 + 1)\mathbf{j}$, find $\dot{\mathbf{r}}(\alpha)$ and $\ddot{\mathbf{r}}(\alpha)$, where $\mathbf{r}(\alpha) = \mathbf{i} + \mathbf{j}$.

Solution

$$\mathbf{r}(t) = e^t\mathbf{i} + ((e^t - 1)^3 + 1)\mathbf{j}$$

$$\dot{\mathbf{r}}(t) = e^t\mathbf{i} + 3e^t(e^t - 1)^2\mathbf{j}$$

$$\ddot{\mathbf{r}}(t) = e^t\mathbf{i} + (6e^{2t}(e^t - 1) + 3e^t(e^t - 1)^2)\mathbf{j}$$

We have

$$\mathbf{r}(\alpha) = e^\alpha\mathbf{i} + ((e^\alpha - 1)^3 + 1)\mathbf{j} = \mathbf{i} + \mathbf{j}$$

Therefore $\alpha = 0$, and $\dot{\mathbf{r}}(0) = \mathbf{i}$ and $\ddot{\mathbf{r}}(0) = \mathbf{i}$.

Example 11

A curve is described by the vector equation $\mathbf{r}(t) = 2 \cos t \mathbf{i} + 3 \sin t \mathbf{j}$.

a Find:

i $\dot{\mathbf{r}}(t)$ **ii** $\ddot{\mathbf{r}}(t)$

b Find the gradient of the curve at the point (x, y) , where $x = 2 \cos t$ and $y = 3 \sin t$.

Solution

a i $\dot{\mathbf{r}}(t) = -2 \sin t \mathbf{i} + 3 \cos t \mathbf{j}$

ii $\ddot{\mathbf{r}}(t) = -2 \cos t \mathbf{i} - 3 \sin t \mathbf{j}$

b We can find $\frac{dy}{dx}$ using related rates:

$$\frac{dy}{dx} = \frac{dy}{dt} \frac{dt}{dx}, \quad \frac{dx}{dt} = -2 \sin t, \quad \frac{dy}{dt} = 3 \cos t$$

$$\therefore \frac{dy}{dx} = 3 \cos t \cdot \frac{1}{-2 \sin t} = -\frac{3}{2} \cot t$$

Note that the gradient is undefined when $\sin t = 0$.

Example 12

A curve is described by the vector equation $\mathbf{r}(t) = \sec(t)\mathbf{i} + \tan(t)\mathbf{j}$, with $t \in \left(-\frac{\pi}{2}, \frac{\pi}{2}\right)$.

- a** Find the gradient of the curve at the point (x, y) , where $x = \sec(t)$ and $y = \tan(t)$.
b Find the gradient of the curve where $t = \frac{\pi}{4}$.

Solution

$$\begin{aligned} \mathbf{a} \quad x &= \sec(t) = \frac{1}{\cos(t)} = (\cos t)^{-1} & \text{and} & \quad y = \tan(t) \\ \frac{dx}{dt} &= -(\cos t)^{-2}(-\sin t) & & \quad \frac{dy}{dt} = \sec^2(t) \\ &= \frac{\sin(t)}{\cos^2(t)} \\ &= \tan(t) \sec(t) \end{aligned}$$

Hence

$$\begin{aligned} \frac{dy}{dx} &= \frac{dy}{dt} \frac{dt}{dx} \\ &= \sec^2(t) \cdot \frac{1}{\tan(t) \sec(t)} \\ &= \sec(t) \cot(t) \\ &= \frac{1}{\sin(t)} \end{aligned}$$

$$\mathbf{b} \quad \text{When } t = \frac{\pi}{4}, \quad \frac{dy}{dx} = \frac{1}{\sin\left(\frac{\pi}{4}\right)} = \sqrt{2}$$

We have the following results for differentiating vector functions.

Properties of the derivative of a vector function

- $\frac{d}{dt}(\mathbf{c}) = \mathbf{0}$, where \mathbf{c} is a constant vector
- $\frac{d}{dt}(k\mathbf{r}(t)) = k \frac{d}{dt}(\mathbf{r}(t))$, where k is a real number
- $\frac{d}{dt}(\mathbf{r}_1(t) + \mathbf{r}_2(t)) = \frac{d}{dt}(\mathbf{r}_1(t)) + \frac{d}{dt}(\mathbf{r}_2(t))$
- $\frac{d}{dt}(f(t)\mathbf{r}(t)) = f(t) \frac{d}{dt}(\mathbf{r}(t)) + \frac{d}{dt}(f(t))\mathbf{r}(t)$, where f is a real-valued function

► Antidifferentiation

$$\begin{aligned}\text{Consider } \int \mathbf{r}(t) dt &= \int x(t)\mathbf{i} + y(t)\mathbf{j} + z(t)\mathbf{k} dt \\ &= \left(\int x(t) dt\right)\mathbf{i} + \left(\int y(t) dt\right)\mathbf{j} + \left(\int z(t) dt\right)\mathbf{k} \\ &= X(t)\mathbf{i} + Y(t)\mathbf{j} + Z(t)\mathbf{k} + \mathbf{c}\end{aligned}$$

where $\frac{dX}{dt} = x(t)$, $\frac{dY}{dt} = y(t)$, $\frac{dZ}{dt} = z(t)$ and \mathbf{c} is a constant vector. Note that $\frac{d\mathbf{c}}{dt} = \mathbf{0}$.

Example 13

Given that $\ddot{\mathbf{r}}(t) = 10\mathbf{i} - 12\mathbf{k}$, find:

a $\dot{\mathbf{r}}(t)$ if $\dot{\mathbf{r}}(0) = 30\mathbf{i} - 20\mathbf{j} + 10\mathbf{k}$

b $\mathbf{r}(t)$ if also $\mathbf{r}(0) = 0\mathbf{i} + 0\mathbf{j} + 2\mathbf{k}$

Solution

a $\dot{\mathbf{r}}(t) = 10t\mathbf{i} - 12t\mathbf{k} + \mathbf{c}_1$, where \mathbf{c}_1 is a constant vector

$$\dot{\mathbf{r}}(0) = 30\mathbf{i} - 20\mathbf{j} + 10\mathbf{k}$$

$$\text{Thus } \mathbf{c}_1 = 30\mathbf{i} - 20\mathbf{j} + 10\mathbf{k}$$

$$\text{and } \dot{\mathbf{r}}(t) = 10t\mathbf{i} - 12t\mathbf{k} + 30\mathbf{i} - 20\mathbf{j} + 10\mathbf{k}$$

$$= (10t + 30)\mathbf{i} - 20\mathbf{j} + (10 - 12t)\mathbf{k}$$

b $\mathbf{r}(t) = (5t^2 + 30t)\mathbf{i} - 20t\mathbf{j} + (10t - 6t^2)\mathbf{k} + \mathbf{c}_2$, where \mathbf{c}_2 is a constant vector

$$\mathbf{r}(0) = 0\mathbf{i} + 0\mathbf{j} + 2\mathbf{k}$$

$$\text{Thus } \mathbf{c}_2 = 2\mathbf{k}$$

$$\text{and } \mathbf{r}(t) = (5t^2 + 30t)\mathbf{i} - 20t\mathbf{j} + (10t - 6t^2 + 2)\mathbf{k}$$

Example 14

Given $\ddot{\mathbf{r}}(t) = -9.8\mathbf{j}$ with $\mathbf{r}(0) = \mathbf{0}$ and $\dot{\mathbf{r}}(0) = 30\mathbf{i} + 40\mathbf{j}$, find $\mathbf{r}(t)$.

Solution

$$\ddot{\mathbf{r}}(t) = -9.8\mathbf{j}$$

$$\therefore \dot{\mathbf{r}}(t) = \left(\int 0 dt\right)\mathbf{i} + \left(\int -9.8 dt\right)\mathbf{j}$$

$$= -9.8t\mathbf{j} + \mathbf{c}_1$$

But $\dot{\mathbf{r}}(0) = 30\mathbf{i} + 40\mathbf{j}$, giving $\mathbf{c}_1 = 30\mathbf{i} + 40\mathbf{j}$.

$$\therefore \dot{\mathbf{r}}(t) = 30\mathbf{i} + (40 - 9.8t)\mathbf{j}$$

$$\text{Thus } \mathbf{r}(t) = \left(\int 30 dt\right)\mathbf{i} + \left(\int 40 - 9.8t dt\right)\mathbf{j}$$

$$= 30t\mathbf{i} + (40t - 4.9t^2)\mathbf{j} + \mathbf{c}_2$$

Now $\mathbf{r}(0) = \mathbf{0}$ and therefore $\mathbf{c}_2 = \mathbf{0}$.

$$\text{Hence } \mathbf{r}(t) = 30t\mathbf{i} + (40t - 4.9t^2)\mathbf{j}.$$

Exercise 16C

Skillsheet

1 Find $\dot{\mathbf{r}}(t)$ and $\ddot{\mathbf{r}}(t)$ for each of the following:

Example 7, 8

a $\mathbf{r}(t) = e^t \mathbf{i} + e^{-t} \mathbf{j}$

b $\mathbf{r}(t) = t \mathbf{i} + t^2 \mathbf{j}$

c $\mathbf{r}(t) = \frac{1}{2}t \mathbf{i} + t^2 \mathbf{j}$

d $\mathbf{r}(t) = 16t \mathbf{i} - 4(4t - 1)^2 \mathbf{j}$

e $\mathbf{r}(t) = \sin(t) \mathbf{i} + \cos(t) \mathbf{j}$

f $\mathbf{r}(t) = (3 + 2t) \mathbf{i} + 5t \mathbf{j}$

g $\mathbf{r}(t) = 100t \mathbf{i} + (100\sqrt{3}t - 4.9t^2) \mathbf{j}$

h $\mathbf{r}(t) = \tan(t) \mathbf{i} + \cos^2(t) \mathbf{j}$

Example 9, 10

2 Sketch graphs for each of the following, for $t \geq 0$, and find $\mathbf{r}(t_0)$, $\dot{\mathbf{r}}(t_0)$ and $\ddot{\mathbf{r}}(t_0)$ for the given t_0 :

a $\mathbf{r}(t) = e^t \mathbf{i} + e^{-t} \mathbf{j}, \quad t_0 = 0$

b $\mathbf{r}(t) = t \mathbf{i} + t^2 \mathbf{j}, \quad t_0 = 1$

c $\mathbf{r}(t) = \sin(t) \mathbf{i} + \cos(t) \mathbf{j}, \quad t_0 = \frac{\pi}{6}$

d $\mathbf{r}(t) = 16t \mathbf{i} - 4(4t - 1)^2 \mathbf{j}, \quad t_0 = 1$

e $\mathbf{r}(t) = \frac{1}{t+1} \mathbf{i} + (t+1)^2 \mathbf{j}, \quad t_0 = 1$

Example 11, 12

3 Find the gradient at the point on the curve determined by the given value of t for each of the following:

a $\mathbf{r}(t) = \cos(t) \mathbf{i} + \sin(t) \mathbf{j}, \quad t = \frac{\pi}{4}$

b $\mathbf{r}(t) = \sin(t) \mathbf{i} + \cos(t) \mathbf{j}, \quad t = \frac{\pi}{2}$

c $\mathbf{r}(t) = e^t \mathbf{i} + e^{-2t} \mathbf{j}, \quad t = 1$

d $\mathbf{r}(t) = 2t^2 \mathbf{i} + 4t \mathbf{j}, \quad t = 2$

e $\mathbf{r}(t) = (t+2) \mathbf{i} + (t^2 - 2t) \mathbf{j}, \quad t = 3$

f $\mathbf{r}(t) = \cos(\pi t) \mathbf{i} + \cos(2\pi t) \mathbf{j}, \quad t = \frac{1}{4}$

Example 13, 14

4 Find $\mathbf{r}(t)$ for each of the following:

a $\dot{\mathbf{r}}(t) = 4\mathbf{i} + 3\mathbf{j}$, where $\mathbf{r}(0) = \mathbf{i} - \mathbf{j}$

b $\dot{\mathbf{r}}(t) = 2t \mathbf{i} + 2\mathbf{j} - 3t^2 \mathbf{k}$, where $\mathbf{r}(0) = \mathbf{i} - \mathbf{j}$

c $\dot{\mathbf{r}}(t) = e^{2t} \mathbf{i} + 2e^{0.5t} \mathbf{j}$, where $\mathbf{r}(0) = \frac{1}{2} \mathbf{i}$

d $\ddot{\mathbf{r}}(t) = \mathbf{i} + 2t \mathbf{j}$, where $\dot{\mathbf{r}}(0) = \mathbf{i}$ and $\mathbf{r}(0) = \mathbf{0}$

e $\ddot{\mathbf{r}}(t) = \sin(2t) \mathbf{i} - \cos(\frac{1}{2}t) \mathbf{j}$, where $\dot{\mathbf{r}}(0) = -\frac{1}{2} \mathbf{i}$ and $\mathbf{r}(0) = 4 \mathbf{j}$

5 The position of a particle at time t is given by $\mathbf{r}(t) = \sin(t) \mathbf{i} + t \mathbf{j} + \cos(t) \mathbf{k}$, where $t \geq 0$. Prove that $\dot{\mathbf{r}}(t)$ and $\ddot{\mathbf{r}}(t)$ are always perpendicular.

6 The position of a particle at time t is given by $\mathbf{r}(t) = 2t \mathbf{i} + 16t^2(3 - t) \mathbf{j}$, where $t \geq 0$. Find:

a when $\dot{\mathbf{r}}(t)$ and $\ddot{\mathbf{r}}(t)$ are perpendicular

b the pairs of perpendicular vectors $\dot{\mathbf{r}}(t)$ and $\ddot{\mathbf{r}}(t)$.

7 A particle has position $\mathbf{r}(t)$ at time t determined by $\mathbf{r}(t) = at \mathbf{i} + \frac{a^2 t^2}{4} \mathbf{j}$, $a > 0$ and $t \geq 0$.

a Sketch the graph of the path of the particle.

b Find when the magnitude of the angle between $\dot{\mathbf{r}}(t)$ and $\ddot{\mathbf{r}}(t)$ is 45° .

- 8** A particle has position $\mathbf{r}(t)$ at time t specified by $\mathbf{r}(t) = 2t\mathbf{i} + (t^2 - 4)\mathbf{j}$, where $t \geq 0$.
- Sketch the graph of the path of the particle.
 - Find the magnitude of the angle between $\dot{\mathbf{r}}(t)$ and $\ddot{\mathbf{r}}(t)$ at $t = 1$.
 - Find when the magnitude of the angle between $\dot{\mathbf{r}}(t)$ and $\ddot{\mathbf{r}}(t)$ is 30° .
- 9** Given $\mathbf{r} = 3t\mathbf{i} + \frac{1}{3}t^3\mathbf{j} + t^3\mathbf{k}$, find:
- $\dot{\mathbf{r}}$
 - $|\dot{\mathbf{r}}|$
 - $\ddot{\mathbf{r}}$
 - $|\ddot{\mathbf{r}}|$
 - t when $|\ddot{\mathbf{r}}| = 16$
- 10** Given that $\mathbf{r} = (V \cos \alpha)t\mathbf{i} + ((V \sin \alpha)t - \frac{1}{2}gt^2)\mathbf{j}$ specifies the position of an object at time $t \geq 0$, find:
- $\dot{\mathbf{r}}$
 - $\ddot{\mathbf{r}}$
 - when $\dot{\mathbf{r}}$ and $\ddot{\mathbf{r}}$ are perpendicular
 - the position of the object when $\dot{\mathbf{r}}$ and $\ddot{\mathbf{r}}$ are perpendicular.



16D Velocity and acceleration for motion along a curve

Consider a particle moving along a curve in the plane, with position vector at time t given by

$$\mathbf{r}(t) = x(t)\mathbf{i} + y(t)\mathbf{j}$$

We can find the particle's velocity and acceleration at time t as follows.

Velocity

Velocity is the rate of change of position.

Therefore $\mathbf{v}(t)$, the velocity at time t , is given by

$$\mathbf{v}(t) = \dot{\mathbf{r}}(t) = \dot{x}(t)\mathbf{i} + \dot{y}(t)\mathbf{j}$$

The velocity vector gives the direction of motion at time t .

Acceleration

Acceleration is the rate of change of velocity.

Therefore $\mathbf{a}(t)$, the acceleration at time t , is given by

$$\mathbf{a}(t) = \dot{\mathbf{v}}(t) = \ddot{\mathbf{r}}(t) = \ddot{x}(t)\mathbf{i} + \ddot{y}(t)\mathbf{j}$$

Speed

Speed is the magnitude of velocity. At time t , the speed is $|\dot{\mathbf{r}}(t)|$.

Distance between two points on the curve

The (shortest) distance between two points on the curve is found using $|\mathbf{r}(t_1) - \mathbf{r}(t_0)|$.

Example 15

The position of an object is $\mathbf{r}(t)$ metres at time t seconds, where $\mathbf{r}(t) = e^t \mathbf{i} + \frac{2}{9}e^{2t} \mathbf{j}$, $t \geq 0$.

Find at time t :

- a** the velocity vector **b** the acceleration vector **c** the speed.

Solution

a $\mathbf{v}(t) = \dot{\mathbf{r}}(t) = e^t \mathbf{i} + \frac{4}{9}e^{2t} \mathbf{j}$

b $\mathbf{a}(t) = \ddot{\mathbf{r}}(t) = e^t \mathbf{i} + \frac{8}{9}e^{2t} \mathbf{j}$

c Speed = $|\mathbf{v}(t)| = \sqrt{(e^t)^2 + (\frac{4}{9}e^{2t})^2} = \sqrt{e^{2t} + \frac{16}{81}e^{4t}}$ m/s

Example 16

The position vector of a particle at time t is given by $\mathbf{r}(t) = (2t - t^2)\mathbf{i} + (t^2 - 3t)\mathbf{j} + 2t\mathbf{k}$, where $t \geq 0$. Find:

- a** the velocity of the particle at time t **b** the speed of the particle at time t
c the minimum speed of the particle.

Solution

a $\dot{\mathbf{r}}(t) = (2 - 2t)\mathbf{i} + (2t - 3)\mathbf{j} + 2\mathbf{k}$

b Speed = $|\dot{\mathbf{r}}(t)| = \sqrt{4 - 8t + 4t^2 + 4t^2 - 12t + 9 + 4}$
 $= \sqrt{8t^2 - 20t + 17}$

- c** Minimum speed occurs when $8t^2 - 20t + 17$ is a minimum.

$$\begin{aligned} 8t^2 - 20t + 17 &= 8\left(t^2 - \frac{5t}{2} + \frac{17}{8}\right) \\ &= 8\left(t^2 - \frac{5t}{2} + \frac{25}{16} + \frac{17}{8} - \frac{25}{16}\right) \\ &= 8\left(\left(t - \frac{5}{4}\right)^2 + \frac{9}{16}\right) \\ &= 8\left(t - \frac{5}{4}\right)^2 + \frac{9}{2} \end{aligned}$$

Hence the minimum speed is $\sqrt{\frac{9}{2}} = \frac{3}{\sqrt{2}} = \frac{3\sqrt{2}}{2}$.

(This occurs when $t = \frac{5}{4}$.)



Example 17

The position of a projectile at time t is given by $\mathbf{r}(t) = 400t\mathbf{i} + (500t - 5t^2)\mathbf{j}$, for $t \geq 0$, where \mathbf{i} is a unit vector in a horizontal direction and \mathbf{j} is a unit vector vertically up.

The projectile is fired from a point on the ground. Find:

- a** the time taken to reach the ground again
- b** the speed at which the projectile hits the ground
- c** the maximum height of the projectile
- d** the initial speed of the projectile.

Solution

- a** The projectile is at ground level when the \mathbf{j} -component of \mathbf{r} is zero:

$$500t - 5t^2 = 0$$

$$5t(100 - t) = 0$$

$$\therefore t = 0 \text{ or } t = 100$$

The projectile reaches the ground again at $t = 100$.

- b** $\dot{\mathbf{r}}(t) = 400\mathbf{i} + (500 - 10t)\mathbf{j}$

The velocity of the projectile when it hits the ground is

$$\dot{\mathbf{r}}(100) = 400\mathbf{i} - 500\mathbf{j}$$

Therefore the speed is

$$|\dot{\mathbf{r}}(100)| = \sqrt{400^2 + 500^2}$$

$$= 100\sqrt{41}$$

The projectile hits the ground with speed $100\sqrt{41}$.

- c** The projectile reaches its maximum height when the \mathbf{j} -component of $\dot{\mathbf{r}}$ is zero:

$$500 - 10t = 0$$

$$\therefore t = 50$$

The maximum height is $500 \times 50 - 5 \times 50^2 = 12\,500$.

- d** The initial velocity is

$$\dot{\mathbf{r}}(0) = 400\mathbf{i} + 500\mathbf{j}$$

So the initial speed is

$$|\dot{\mathbf{r}}(0)| = \sqrt{400^2 + 500^2}$$

$$= 100\sqrt{41}$$

Example 18

The position vector of a particle at time t is given by $\mathbf{r}(t) = 2 \sin(2t)\mathbf{i} + \cos(2t)\mathbf{j} + 2t\mathbf{k}$, where $t \geq 0$. Find:

- a** the velocity at time t **b** the speed of the particle at time t
c the maximum speed **d** the minimum speed.

Solution

a $\dot{\mathbf{r}}(t) = 4 \cos(2t)\mathbf{i} - 2 \sin(2t)\mathbf{j} + 2\mathbf{k}$

b Speed $= |\dot{\mathbf{r}}(t)| = \sqrt{16 \cos^2(2t) + 4 \sin^2(2t) + 4}$
 $= \sqrt{12 \cos^2(2t) + 8}$

c Maximum speed $= \sqrt{20} = 2\sqrt{5}$, when $\cos(2t) = 1$

d Minimum speed $= \sqrt{8} = 2\sqrt{2}$, when $\cos(2t) = 0$

**Example 19**

The position vectors, at time $t \geq 0$, of particles A and B are given by

$$\mathbf{r}_A(t) = (t^3 - 9t + 8)\mathbf{i} + t^2\mathbf{j}$$

$$\mathbf{r}_B(t) = (2 - t^2)\mathbf{i} + (3t - 2)\mathbf{j}$$

Prove that A and B collide while travelling at the same speed but at right angles to each other.

Solution

When the particles collide, they must be at the same position at the same time:

$$(t^3 - 9t + 8)\mathbf{i} + t^2\mathbf{j} = (2 - t^2)\mathbf{i} + (3t - 2)\mathbf{j}$$

Thus $t^3 - 9t + 8 = 2 - t^2$ **(1)**

and $t^2 = 3t - 2$ **(2)**

From (1): $t^3 + t^2 - 9t + 6 = 0$ **(3)**

From (2): $t^2 - 3t + 2 = 0$ **(4)**

Equation (4) is simpler to solve:

$$(t - 2)(t - 1) = 0$$

$\therefore t = 2$ or $t = 1$

Now check in (3):

$$t = 1 \quad \text{LHS} = 1 + 1 - 9 + 6 = -1 \neq \text{RHS}$$

$$t = 2 \quad \text{LHS} = 8 + 4 - 18 + 6 = 0 = \text{RHS}$$

The particles collide when $t = 2$.

Now consider the speeds when $t = 2$.

$$\dot{\mathbf{r}}_A(t) = (3t^2 - 9)\mathbf{i} + 2t\mathbf{j} \quad \dot{\mathbf{r}}_B(t) = -2t\mathbf{i} + 3\mathbf{j}$$

$$\therefore \dot{\mathbf{r}}_A(2) = 3\mathbf{i} + 4\mathbf{j} \quad \dot{\mathbf{r}}_B(2) = -4\mathbf{i} + 3\mathbf{j}$$

The speed of particle A is $\sqrt{3^2 + 4^2} = 5$.

The speed of particle B is $\sqrt{(-4)^2 + 3^2} = 5$.

The speeds of the particles are equal at the time of collision.

Consider the scalar product of the velocity vectors for A and B at time $t = 2$.

$$\begin{aligned} \dot{\mathbf{r}}_A(2) \cdot \dot{\mathbf{r}}_B(2) &= (3\mathbf{i} + 4\mathbf{j}) \cdot (-4\mathbf{i} + 3\mathbf{j}) \\ &= -12 + 12 \\ &= 0 \end{aligned}$$

Hence the velocities are perpendicular at $t = 2$.

The particles are travelling at right angles at the time of collision.

Exercise 16D

All distances are measured in metres and time in seconds.

Skillsheet

1 The position of a particle at time t is given by $\mathbf{r}(t) = t^2\mathbf{i} - (1 + 2t)\mathbf{j}$, for $t \geq 0$. Find:

Example 15

- the velocity at time t
- the acceleration at time t
- the average velocity for the first 2 seconds, i.e. $\frac{\mathbf{r}(2) - \mathbf{r}(0)}{2}$.

2 The acceleration of a particle at time t is given by $\ddot{\mathbf{r}}(t) = -g\mathbf{j}$, where $g = 9.8$. Find:

- the velocity at time t if $\dot{\mathbf{r}}(0) = 2\mathbf{i} + 6\mathbf{j}$
- the position at time t if $\mathbf{r}(0) = 0\mathbf{i} + 6\mathbf{j}$.

Example 16

3 The velocity of a particle at time t is given by $\dot{\mathbf{r}}(t) = 3\mathbf{i} + 2t\mathbf{j} + (1 - 4t)\mathbf{k}$, for $t \geq 0$.

- Find the acceleration of the particle at time t .
- Find the position of the particle at time t if initially the particle is at $\mathbf{j} + \mathbf{k}$.
- Find an expression for the speed at time t .
- Find the time at which the minimum speed occurs.
 - Find this minimum speed.

4 The acceleration of a particle at time t is given by $\ddot{\mathbf{r}}(t) = 10\mathbf{i} - g\mathbf{k}$, where $g = 9.8$. Find:

- the velocity of the particle at time t if $\dot{\mathbf{r}}(0) = 20\mathbf{i} - 20\mathbf{j} + 40\mathbf{k}$
- the position of the particle at time t , given that $\mathbf{r}(0) = 0\mathbf{i} + 0\mathbf{j} + 0\mathbf{k}$.

5 The position of an object at time t is given by $\mathbf{r}(t) = 5 \cos(1 + t^2)\mathbf{i} + 5 \sin(1 + t^2)\mathbf{j}$. Find the speed of the object at time t .

- 6** The position of a particle, $\mathbf{r}(t)$, at time t seconds is given by $\mathbf{r}(t) = 2t\mathbf{i} + (t^2 - 4)\mathbf{j}$. Find the magnitude of the angle between the velocity and acceleration vectors at $t = 1$.
- 7** The position vector of a particle is given by $\mathbf{r}(t) = 12\sqrt{t}\mathbf{i} + t^{\frac{3}{2}}\mathbf{j}$, for $t \geq 0$. Find the minimum speed of the particle and its position when it has this speed.

Example 17

- 8** The position, $\mathbf{r}(t)$, of a projectile at time t is given by $\mathbf{r}(t) = 400t\mathbf{i} + (300t - 4.9t^2)\mathbf{j}$, for $t \geq 0$. If the projectile is initially at ground level, find:
- the time taken to return to the ground
 - the speed at which the object hits the ground
 - the maximum height reached
 - the initial speed of the object
 - the initial angle of projection from the horizontal.
- 9** The acceleration of a particle at time t is given by $\ddot{\mathbf{r}}(t) = -3(\sin(3t)\mathbf{i} + \cos(3t)\mathbf{j})$.
- Find the position vector $\mathbf{r}(t)$, given that $\dot{\mathbf{r}}(0) = \mathbf{i}$ and $\mathbf{r}(0) = -3\mathbf{i} + 3\mathbf{j}$.
 - Show that the path of the particle is circular and state the position of its centre.
 - Show that the acceleration is always perpendicular to the velocity.

Example 18

- 10** The position vector of a particle at time t is $\mathbf{r}(t) = 2\cos(t)\mathbf{i} + 4\sin(t)\mathbf{j} + 2t\mathbf{k}$. Find the maximum and minimum speeds of the particle.
- 11** The velocity vector of a particle at time t seconds is given by

$$\mathbf{v}(t) = (2t + 1)^2\mathbf{i} + \frac{1}{\sqrt{2t + 1}}\mathbf{j}$$

- Find the magnitude and direction of the acceleration after 1 second.
- Find the position vector at time t seconds if the particle is initially at O .

Example 19

- 12** Particles A and B move in the x - y plane with constant velocities.

- $\dot{\mathbf{r}}_A(t) = \mathbf{i} + 2\mathbf{j}$ and $\mathbf{r}_A(2) = 3\mathbf{i} + 4\mathbf{j}$
- $\dot{\mathbf{r}}_B(t) = 2\mathbf{i} + 3\mathbf{j}$ and $\mathbf{r}_B(3) = \mathbf{i} + 3\mathbf{j}$

Prove that the particles collide, finding:

- the time of collision
 - the position vector of the point of collision.
- 13** A body moves horizontally along a straight line in a direction $N\alpha^\circ W$ with a constant speed of 20 m/s. If \mathbf{i} is a horizontal unit vector due east and \mathbf{j} is a horizontal unit vector due north and if $\tan \alpha^\circ = \frac{4}{3}$, find:
- the velocity of the body at time t
 - the position of the body after 5 seconds.
- 14** The position vector of a particle at time t is $\mathbf{r}(t) = 4\sin(2t)\mathbf{i} + 4\cos(2t)\mathbf{j}$, $t \geq 0$. Find:
- the velocity at time t
 - the speed at time t
 - the acceleration in terms of \mathbf{r} .

- 15** The velocity of a particle is given by $\dot{\mathbf{r}}(t) = (2t - 5)\mathbf{i}$, $t \geq 0$. Initially, the position of the particle relative to an origin O is $-2\mathbf{i} + 2\mathbf{j}$.
- Find the position of the particle at time t .
 - Find the position of the particle when it is instantaneously at rest.
 - Find the Cartesian equation of the path followed by the particle.
- 16** A particle has path defined by $\mathbf{r}(t) = 6 \sec(t)\mathbf{i} + 4 \tan(t)\mathbf{j}$, $t \geq 0$. Find:
- the Cartesian equation of the path
 - the particle's velocity at time t .
- 17** A particle moves such that its position vector, $\mathbf{r}(t)$, at time t is given by $\mathbf{r}(t) = 4 \cos(t)\mathbf{i} + 3 \sin(t)\mathbf{j}$, $0 \leq t \leq 2\pi$.
- Find the Cartesian equation of the path of the particle and sketch the path.
 - Find when the velocity of the particle is perpendicular to its position vector.
 - Find the position vector of the particle at each of these times.
 - Find the speed of the particle at time t .
 - Write the speed in terms of $\cos^2 t$.
 - State the maximum and minimum speeds of the particle.



16E Projectile motion

Suppose that a particle is projected at an angle of θ° to the horizontal with initial velocity \mathbf{u} .

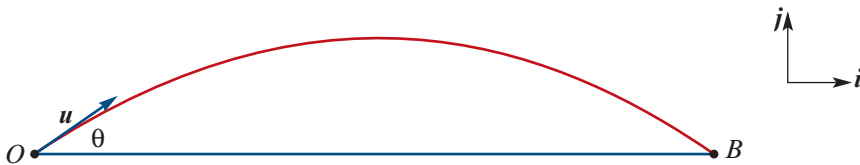

Let \mathbf{i} and \mathbf{j} be unit vectors in the horizontal and vertical directions as shown, and let $\mathbf{r}(t)$ be the position vector of the particle at time t . Then we can write

$$\dot{\mathbf{r}}(0) = \mathbf{u} = u \cos \theta \mathbf{i} + u \sin \theta \mathbf{j}$$

where u is the magnitude of the initial velocity \mathbf{u} .

We will assume that the only force acting on the particle is gravity. So we have

$$\ddot{\mathbf{r}}(t) = -g\mathbf{j}$$

where g is the acceleration due to gravity. Integrating with respect to t gives

$$\dot{\mathbf{r}}(t) = -gt\mathbf{j} + \mathbf{c}$$

We see that $\mathbf{c} = \dot{\mathbf{r}}(0) = u \cos \theta \mathbf{i} + u \sin \theta \mathbf{j}$. So we obtain

$$\dot{\mathbf{r}}(t) = u \cos \theta \mathbf{i} + (u \sin \theta - gt)\mathbf{j}$$

If we assume that $\mathbf{r}(0) = \mathbf{0}$, then integrating again with respect to t gives

$$\mathbf{r}(t) = ut \cos \theta \mathbf{i} + \left(ut \sin \theta - \frac{gt^2}{2} \right) \mathbf{j}$$

Equations of projectile motion

For an object projected from the origin with initial velocity $\dot{\mathbf{r}}(0) = u \cos \theta \mathbf{i} + u \sin \theta \mathbf{j}$:

Acceleration $\ddot{\mathbf{r}}(t) = -g\mathbf{j}$

Velocity $\dot{\mathbf{r}}(t) = u \cos \theta \mathbf{i} + (u \sin \theta - gt)\mathbf{j}$

Position $\mathbf{r}(t) = ut \cos \theta \mathbf{i} + \left(ut \sin \theta - \frac{gt^2}{2} \right) \mathbf{j}$

Note: Close to the Earth's surface, we can take $g \approx 9.8 \text{ m/s}^2$.

Cartesian equation of the projectile's path

We can write the position function, $\mathbf{r}(t)$, as parametric equations:

$$x = ut \cos \theta \quad (1) \qquad y = ut \sin \theta - \frac{gt^2}{2} \quad (2)$$

Solve equation (1) for t and substitute into equation (2):

$$y = u \left(\frac{x}{u \cos \theta} \right) \sin \theta - \frac{g}{2} \left(\frac{x}{u \cos \theta} \right)^2$$

Hence the Cartesian equation of the projectile's path is

$$y = x \tan \theta - \frac{gx^2}{2u^2} \sec^2 \theta$$

Maximum height of the projectile

The maximum height is reached when the \mathbf{j} -component of the velocity, $\dot{\mathbf{r}}(t)$, is zero. This implies that $u \sin \theta - gt = 0$, and so

$$t = \frac{u \sin \theta}{g}$$

Therefore the position vector of the particle at its maximum height is

$$\begin{aligned} \mathbf{r}(t) &= ut \cos \theta \mathbf{i} + \left(ut \sin \theta - \frac{gt^2}{2} \right) \mathbf{j} \\ &= \frac{u^2 \sin \theta \cos \theta}{g} \mathbf{i} + \left(\frac{u^2 \sin^2 \theta}{g} - \frac{gu^2 \sin^2 \theta}{2g^2} \right) \mathbf{j} \\ &= \frac{u^2}{2g} (\sin(2\theta) \mathbf{i} + \sin^2 \theta \mathbf{j}) \end{aligned}$$

Hence the maximum height is $\frac{u^2}{2g} \sin^2 \theta$.

Range of the projectile

If the projectile returns to the same horizontal level as the point of projection, then the total horizontal distance travelled (the projectile's range) is twice the horizontal distance travelled to reach the maximum height.

Hence the range of the projectile is $\frac{u^2}{g} \sin(2\theta)$.

Example 20

A particle is projected from a point on horizontal ground with speed 50 m/s at an angle of 30° to the horizontal. Let \mathbf{i} and \mathbf{j} be unit vectors in the horizontal (x) and vertical (y) directions respectively. Neglecting air resistance, find:

- a** the initial velocity vector **b** the velocity vector at time t seconds
c the position vector at time t seconds **d** the Cartesian equation of the path.

Solution

a The initial velocity is

$$\begin{aligned}\mathbf{u} &= 50 \cos 30^\circ \mathbf{i} + 50 \sin 30^\circ \mathbf{j} \\ &= 25\sqrt{3}\mathbf{i} + 25\mathbf{j}\end{aligned}$$

b We have

$$\begin{aligned}\ddot{\mathbf{r}}(t) &= -g\mathbf{j} \\ \therefore \dot{\mathbf{r}}(t) &= -gt\mathbf{j} + \mathbf{c}_1\end{aligned}$$

We see that $\mathbf{c}_1 = \dot{\mathbf{r}}(0) = 25\sqrt{3}\mathbf{i} + 25\mathbf{j}$.
Hence

$$\dot{\mathbf{r}}(t) = 25\sqrt{3}\mathbf{i} + (25 - gt)\mathbf{j}$$

c We have

$$\begin{aligned}\dot{\mathbf{r}}(t) &= 25\sqrt{3}\mathbf{i} + (25 - gt)\mathbf{j} \\ \therefore \mathbf{r}(t) &= 25\sqrt{3}t\mathbf{i} + (25t - \frac{1}{2}gt^2)\mathbf{j} + \mathbf{c}_2\end{aligned}$$

But $\mathbf{r}(0) = \mathbf{0}$ implies that $\mathbf{c}_2 = \mathbf{0}$.

Hence

$$\mathbf{r}(t) = 25\sqrt{3}t\mathbf{i} + (25t - \frac{1}{2}gt^2)\mathbf{j}$$

d From part **c**, we can write

$$x = 25\sqrt{3}t \quad \text{and} \quad y = 25t - \frac{1}{2}gt^2$$

Eliminating t gives

$$\begin{aligned}y &= \frac{25x}{25\sqrt{3}} - \frac{1}{2}g\left(\frac{x}{25\sqrt{3}}\right)^2 \\ \therefore y &= \frac{\sqrt{3}x}{3} - \frac{gx^2}{3750}\end{aligned}$$

Exercise 16E**Skillsheet****Example 20**

- 1** A particle is projected from a point on horizontal ground with speed 98 m/s at an angle of 30° to the horizontal. Let \mathbf{i} and \mathbf{j} be unit vectors in the horizontal (x) and vertical (y) directions respectively. Neglecting air resistance, find:
- a** the initial velocity vector **b** the velocity vector at time t seconds
c the position vector at time t seconds **d** the Cartesian equation of the path.
- 2** A particle is projected from a height of 50 m at an angle of 30° to the horizontal, with an initial speed of 10g m/s. After t seconds, the particle is at a height of y m above ground level and at a horizontal distance of x m from the point of projection.
- a** Express y in terms of x .
b Hence find, in terms of g , the particle's horizontal distance from the point of projection when it is at a height of 25 m above ground level.
- 3** A ball is thrown horizontally at 15 m/s from the window of a tall building, and it hits the ground after 2.5 seconds. Find the height above ground level of the point from which the ball was thrown.

- 4** An object slides down an inclined plane, which slopes downwards at an angle of 20° to the horizontal. The object reaches a speed of 40 m/s at the end of the slide, which is 15 m above the ground. Take the end of the slide as the origin, and let \mathbf{i} and \mathbf{j} be unit vectors in the forwards and upwards directions respectively.
- a** Let $\mathbf{r}(t)$ be the position of the object at time t seconds after leaving the end of the slide. Using $\ddot{\mathbf{r}}(t) = -g\mathbf{j}$, find $\mathbf{r}(t)$.
- Hence find, correct to one decimal place:
- b** the horizontal distance, in metres, travelled by the object to reach the ground after it leaves the end of the slide
- c** the angle upwards from the horizontal, in degrees, at which it hits the ground.
- 5** A stone is thrown to hit a small target, which is at a distance of 14 m horizontally and 5.5 m vertically upwards from the point of projection. The stone is thrown from a height of 2 m above the horizontal ground with a speed of 42 m/s. Find, in degrees correct to one decimal place, the angle from the horizontal at which the stone should be thrown to hit the target. (Assume that there is no air resistance.)
- 6** An object is launched upwards at an angle of α° from the horizontal with an initial speed of u m/s. The only force acting is gravity.
- a** Express $\dot{\mathbf{r}}$, the velocity of the object (in m/s) at time t s, in terms of t , u , g and α .
- b** At time T s, the object is moving in a direction perpendicular to that of projection. Find the relationship between T , u , g and α .
- 7** An object is projected with speed u m/s at an angle of θ° upwards from the horizontal. The maximum height reached is H metres and the range is R metres (i.e. the horizontal distance between the point of projection and the point of landing). Show that

$$u = \sqrt{\frac{2g(H + R^2)}{16H}}$$

- 8** A ball is thrown at an angle of $\arctan\left(\frac{12}{5}\right)$ to the horizontal. If the ball hits a building 10 m away at a height of 14 m, find its initial velocity.
- 9** A ball is projected from ground level over a wall of height 5 m. The point of projection is 20 m from the base of the wall. The initial speed of the ball is 40 m/s at an angle of 30° to the horizontal. Assume that air resistance is negligible.
- a** How far above the top of the wall does the ball pass? (Give your answer in metres correct to one decimal place.)
- b** What is the speed of the ball as it passes over the top of the wall? (Give your answer in m/s correct to one decimal place.)
- 10** Particle X is projected from the origin with an initial velocity of $16\mathbf{i} + 30\mathbf{j}$ m/s. At the same time, particle Y is projected from a point 60 m to the right of the origin and 25 m higher with an initial velocity of $-8\mathbf{i} + 20\mathbf{j}$ m/s.
- a** Find the position vector of particle X at time t seconds.
- b** Find the time and the point at which the two particles collide.

- 11** A particle is projected with initial velocity \mathbf{u} from a point O .
- Write an expression for the velocity, \mathbf{v} , of the particle at time t .
 - Write an expression for the position, \mathbf{r} , of the particle at time t .
 - Prove that, at the time t when the vectors \mathbf{u} and \mathbf{v} are perpendicular, we have

$$|\mathbf{u}|^2 + |\mathbf{v}|^2 = \frac{4|\mathbf{r}|^2}{t^2} \text{ and } |\mathbf{r}| = \frac{1}{2}gt^2.$$



16F Circular motion

Suppose that a particle P is moving around the circle centred at the origin with radius r . The position of the particle is given by

$$\mathbf{r} = r \cos \theta \mathbf{i} + r \sin \theta \mathbf{j}$$

where $\theta = f(t)$. That is, we consider the angle, θ , to be a function of time, t .

We can find the velocity of the particle by first using the chain rule to obtain

$$\frac{d}{dt}(\cos \theta) = -\sin \theta \cdot \frac{d\theta}{dt} = -\dot{\theta} \sin \theta$$

$$\frac{d}{dt}(\sin \theta) = \cos \theta \cdot \frac{d\theta}{dt} = \dot{\theta} \cos \theta$$

Hence

$$\begin{aligned} \dot{\mathbf{r}} &= -r\dot{\theta} \sin \theta \mathbf{i} + r\dot{\theta} \cos \theta \mathbf{j} \\ &= r\dot{\theta}(-\sin \theta \mathbf{i} + \cos \theta \mathbf{j}) \end{aligned}$$

It can be seen that $-\sin \theta \mathbf{i} + \cos \theta \mathbf{j}$ is a unit vector, and so $r|\dot{\theta}|$ is the magnitude of $\dot{\mathbf{r}}$.

We also observe that $\mathbf{r} \cdot \dot{\mathbf{r}} = 0$. Therefore the velocity vector is perpendicular to the position vector.

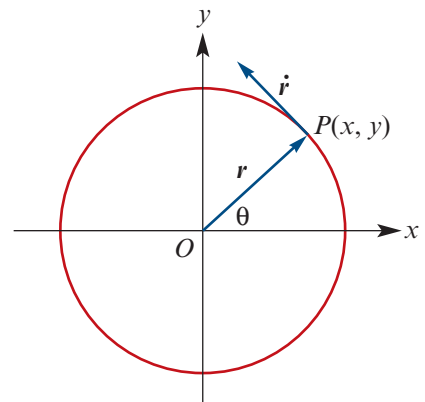
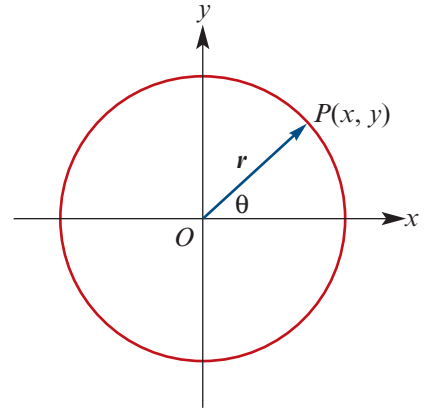

Angular velocity

The **angular velocity** of the particle, denoted by ω , is the rate of change of the angle θ with respect to time:

$$\omega = \frac{d\theta}{dt} = \dot{\theta}$$

Note: The standard unit for angular velocity is radians per second.

We have seen that the magnitude of the velocity is $|\dot{\mathbf{r}}| = r|\dot{\theta}|$. So we can now write

$$v = r|\omega|$$

where v is the speed of the particle.

► Uniform circular motion

Throughout the rest of this section, we will consider circular motion where the angular velocity ω is constant. This is called **uniform circular motion**.

If the particle starts at an angle of $\theta = 0$ at time $t = 0$, then we have $\theta = \omega t$ and the equations of motion are

$$\begin{aligned}\mathbf{r} &= r(\cos(\omega t)\mathbf{i} + \sin(\omega t)\mathbf{j}) \\ \dot{\mathbf{r}} &= r\omega(-\sin(\omega t)\mathbf{i} + \cos(\omega t)\mathbf{j}) \\ \ddot{\mathbf{r}} &= r\omega^2(-\cos(\omega t)\mathbf{i} - \sin(\omega t)\mathbf{j})\end{aligned}$$

We see that the acceleration is directed along a radius towards the centre of the circle.

Uniform circular motion

For a particle moving around a circle of radius r with constant angular velocity $\omega > 0$:

- **Speed** The speed of the particle is $v = r\omega$.
- **Period** The time to complete one revolution is $T = \frac{2\pi}{\omega}$.

Example 21

A particle is moving around a circle of radius 3 m with a constant speed of 2 m/s. Given that $\theta = 0$ at time $t = 0$, find:

- a the angular velocity of the particle
- b the position of the particle at time $t = \pi$ seconds
- c the velocity of the particle at time $t = \pi$ seconds
- d the acceleration of the particle at time $t = \pi$ seconds.

Solution

- a** We are given that $v = 2$ m/s and $r = 3$ m.

Therefore the angular velocity is $\omega = \frac{v}{r} = \frac{2}{3}$ radians per second.

- b** When $t = \pi$, the particle is at an angle of $\theta = \omega t = \frac{2\pi}{3}$.

$$\begin{aligned}\text{So } \mathbf{r} &= r(\cos \theta \mathbf{i} + \sin \theta \mathbf{j}) \\ &= 3\left(\cos\left(\frac{2\pi}{3}\right)\mathbf{i} + \sin\left(\frac{2\pi}{3}\right)\mathbf{j}\right) \\ &= -\frac{3}{2}\mathbf{i} + \frac{3\sqrt{3}}{2}\mathbf{j}\end{aligned}$$

- c** $\dot{\mathbf{r}} = r\omega(-\sin \theta \mathbf{i} + \cos \theta \mathbf{j})$
- $$\begin{aligned}&= 3 \times \frac{2}{3}\left(-\sin\left(\frac{2\pi}{3}\right)\mathbf{i} + \cos\left(\frac{2\pi}{3}\right)\mathbf{j}\right) \\ &= -\sqrt{3}\mathbf{i} - \mathbf{j} \text{ m/s}\end{aligned}$$

- d** $\ddot{\mathbf{r}} = r\omega^2(-\cos \theta \mathbf{i} - \sin \theta \mathbf{j})$
- $$\begin{aligned}&= 3 \times \left(\frac{2}{3}\right)^2\left(-\cos\left(\frac{2\pi}{3}\right)\mathbf{i} - \sin\left(\frac{2\pi}{3}\right)\mathbf{j}\right) \\ &= \frac{2}{3}\mathbf{i} - \frac{2\sqrt{3}}{3}\mathbf{j} \text{ m/s}^2\end{aligned}$$

Example 22

A particle moves at a constant speed of 8 m/s around a circle with a radius of 4 m. Assume that $\theta = 0$ when $t = 0$.

- a Find the position of the particle, relative to the centre of the circle, at time t seconds.
- b Find the velocity of the particle at time t seconds.
- c Find the acceleration of the particle at time t seconds.

Solution

The angular velocity is $\omega = \frac{v}{r} = 2$ radians per second.

At time t seconds, the angle is $\theta = 2t$.

- a $\mathbf{r} = 4 \cos(2t)\mathbf{i} + 4 \sin(2t)\mathbf{j}$
- b $\dot{\mathbf{r}} = -8 \sin(2t)\mathbf{i} + 8 \cos(2t)\mathbf{j}$
- c $\ddot{\mathbf{r}} = -16 \cos(2t)\mathbf{i} - 16 \sin(2t)\mathbf{j}$

Exercise 16F*Skillsheet***Example 21**

- 1 A particle is moving around a circle of radius 2.5 m with a constant speed of 5 m/s. Given that $\theta = 0$ at time $t = 0$, find:
 - a the angular velocity of the particle
 - b the position of the particle at time $t = \pi$ seconds
 - c the velocity of the particle at time $t = \pi$ seconds
 - d the acceleration of the particle at time $t = \pi$ seconds.
- 2 A particle is moving around a circle with a constant speed of 2 m/s. The radius of the circle is 2 m. Given that $\theta = 0$ at time $t = 0$, find:
 - a the angular velocity of the particle
 - b the position of the particle at time $t = \frac{\pi}{2}$ seconds
 - c the velocity of the particle at time $t = \frac{\pi}{2}$ seconds
 - d the acceleration of the particle at time $t = \frac{\pi}{2}$ seconds.
- 3 An electric fan is spinning at 350 revolutions per minute. The fan's diameter is 20 cm.
 - a Find the angular velocity of a point at the end of a fan blade.
 - b Find the speed of a point at the end of a fan blade.

Example 22

- 4 A car is driving around a circular track with a radius of 25 m at a constant speed of 10 m/s. Assume that $\theta = 0$ when $t = 0$.
 - a Find the position of the car, relative to the centre of the circle, at time t seconds.
 - b Find the velocity of the car at time t seconds.
 - c Find the acceleration of the car at time t seconds.

- 5 A tyre of radius 25 cm is rotating at a constant rate such that a point on its rim has speed $\frac{25}{3}$ m/s. Find the angular velocity of a point on its rim, in radians per second.
- 6 A particle moves in a circle of radius 2 m and completes 1.5 revolutions per second. Find:
- a** the angular velocity **b** the speed
c the magnitude of the acceleration **d** the period of the motion.

- 7 A particle moves such that its position vector, $\mathbf{r}(t)$, at time t is given by

$$\mathbf{r}(t) = 3 \sin(4\pi t) \mathbf{i} - 3 \cos(4\pi t) \mathbf{j}, \quad t \geq 0$$

All distances are in metres and time is in seconds.

- a** Find the speed of the particle in m/s.
b Find the magnitude of the acceleration in m/s^2 .
c Find the position, velocity and acceleration vectors at time $t = \frac{1}{2}$ second.
d Find the angular velocity of the particle in radians per second.
- 8 A particle moves in a circle such that its position vector at time t is given by

$$\mathbf{r}(t) = a \cos(nt) \mathbf{i} + a \sin(nt) \mathbf{j}, \quad t \geq 0$$

where a and n are positive constants. Given that the circle has a radius of length 2 metres and the particle completes 80 revolutions per minute, find:

- a** the constants a and n **b** the particle's speed in m/s
c the magnitude of the acceleration in m/s^2 .
- 9 A particle moves so that its position vector at time t is given by

$$\mathbf{r} = 4 \cos(t^2) \mathbf{i} + 4 \sin(t^2) \mathbf{j}, \quad t \geq 0$$

- a** Show that the particle moves in a circle.
b Find $\dot{\mathbf{r}}$ and hence show that the particle does not move with constant speed.
c Find $\ddot{\mathbf{r}}$ and express your answer in the form $\ddot{\mathbf{r}} = f(t)\mathbf{r} + g(t)\dot{\mathbf{r}}$.

- 10 A particle moves such that its position vector, $\mathbf{r}(t)$, is given by

$$\mathbf{r}(t) = (4 + 3 \cos(4\pi t)) \mathbf{i} + (2 - 3 \sin(4\pi t)) \mathbf{j}, \quad t \geq 0$$

All distances are in metres and time is in seconds.

- a** Find the speed of the particle in m/s.
b Find the magnitude of the acceleration in m/s^2 .
c Find the position, velocity and acceleration vectors at time $t = 1$ second.
d Find the angular velocity of the particle relative to the centre of motion.
e Find the Cartesian equation of the particle's path.



Chapter summary



- We state the following results for motion in three dimensions. In this course, the focus is on motion in the plane. The statements for two dimensions are analogous.

- The position of a particle at time t can be described by a vector function:

$$\mathbf{r}(t) = f(t)\mathbf{i} + g(t)\mathbf{j} + h(t)\mathbf{k}$$

- The velocity of the particle at time t is

$$\dot{\mathbf{r}}(t) = f'(t)\mathbf{i} + g'(t)\mathbf{j} + h'(t)\mathbf{k}$$

- The acceleration of the particle at time t is

$$\ddot{\mathbf{r}}(t) = f''(t)\mathbf{i} + g''(t)\mathbf{j} + h''(t)\mathbf{k}$$

- The velocity vector $\dot{\mathbf{r}}(t)$ has the direction of the motion of the particle at time t .
- Speed is the magnitude of velocity. At time t , the speed is $|\dot{\mathbf{r}}(t)|$.
- The (shortest) distance between the points on the path corresponding to $t = t_0$ and $t = t_1$ is given by $|\mathbf{r}(t_1) - \mathbf{r}(t_0)|$.

■ Circular motion

- For a particle moving around the origin in the x - y plane, let θ be the angle that its position vector makes with the positive direction of the x -axis. The **angular velocity** of the particle, ω , is the rate of change of θ with respect to time.
- For a particle moving around a circle of radius r with constant angular velocity $\omega > 0$:
 - the speed of the particle is $v = r\omega$
 - the period of the motion is $T = \frac{2\pi}{\omega}$.

Short-answer questions

- The position, $\mathbf{r}(t)$ metres, of a particle moving in a plane is given by $\mathbf{r}(t) = 2t\mathbf{i} + (t^2 - 4)\mathbf{j}$ at time t seconds.
 - Find the velocity and acceleration when $t = 2$.
 - Find the Cartesian equation of the path.
- Find the velocity and acceleration vectors of the position vectors:
 - $\mathbf{r} = 2t^2\mathbf{i} + 4t\mathbf{j} + 8\mathbf{k}$
 - $\mathbf{r} = 4 \sin t\mathbf{i} + 4 \cos t\mathbf{j} + t^2\mathbf{k}$
- At time t , a particle has coordinates $(6t, t^2 + 4)$. Find the unit vector along the tangent to the path when $t = 4$.
- The position vector of a particle is given by $\mathbf{r}(t) = 10 \sin(2t)\mathbf{i} + 5 \cos(2t)\mathbf{j}$.
 - Find its position vector when $t = \frac{\pi}{6}$.
 - Find the cosine of the angle between its directions of motion at $t = 0$ and $t = \frac{\pi}{6}$.

- 5** Find the unit tangent vector of the curve $\mathbf{r} = (\cos t + t \sin t)\mathbf{i} + (\sin t - t \cos t)\mathbf{j}$, $t > 0$.
- 6** A particle moves on a curve with equation $\mathbf{r} = 5(\cos t \mathbf{i} + \sin t \mathbf{j})$. Find:
- a** the velocity at time t
 - b** the speed at time t
 - c** the acceleration at time t
 - d** $\dot{\mathbf{r}} \cdot \ddot{\mathbf{r}}$, and comment.
- 7** Particles A and B move with velocities $\mathbf{V}_A = \cos t \mathbf{i} + \sin t \mathbf{j}$ and $\mathbf{V}_B = \sin t \mathbf{i} + \cos t \mathbf{j}$ respectively. At time $t = 0$, the position vectors of A and B are $\mathbf{r}_A = \mathbf{i}$ and $\mathbf{r}_B = \mathbf{j}$. Prove that the particles collide, finding the time of collision.
- 8** The position vector of a particle at any time t is given by $\mathbf{r} = (1 + \sin t)\mathbf{i} + (1 - \cos t)\mathbf{j}$.
- a** Show that the magnitudes of the velocity and acceleration are constants.
 - b** Find the Cartesian equation of the path described by the particle.
 - c** Find the first instant that the position is perpendicular to the velocity.
- 9** The velocities of two particles A and B are given by $\mathbf{V}_A = 2\mathbf{i} + 3\mathbf{j}$ and $\mathbf{V}_B = 3\mathbf{i} - 4\mathbf{j}$. The initial position vector of particle A is $\mathbf{r}_A = \mathbf{i} - \mathbf{j}$. If the particles collide after 3 seconds, find the initial position vector of particle B .
- 10** A particle starts from point $\mathbf{i} - 2\mathbf{j}$ and travels with a velocity given by $t\mathbf{i} + \mathbf{j}$, at time t seconds from the start. A second particle travels in the same plane and its position vector is given by $\mathbf{r} = (s - 4)\mathbf{i} + 3\mathbf{j}$, at time s seconds after it started.
- a** Find an expression for the position of the first particle.
 - b** Find the point at which their paths cross.
 - c** If the particles actually collide, find the time between the two starting times.
- 11** A particle travels with constant acceleration, given by $\ddot{\mathbf{r}}(t) = \mathbf{i} + 2\mathbf{j}$. Two seconds after starting, the particle passes through the point \mathbf{i} , travelling at a velocity of $2\mathbf{i} - \mathbf{j}$. Find:
- a** an expression for the velocity of the particle at time t
 - b** an expression for its position
 - c** the initial position and velocity of the particle.
- 12** Two particles travel with constant acceleration given by $\ddot{\mathbf{r}}_1(t) = \mathbf{i} - \mathbf{j}$ and $\ddot{\mathbf{r}}_2(t) = 2\mathbf{i} + \mathbf{j}$. The initial velocity of the second particle is $-4\mathbf{i}$ and that of the first particle is $k\mathbf{j}$.
- a** Find an expression for:
 - i** the velocity of the second particle
 - ii** the velocity of the first particle.
 - b** At one instant both particles have the same velocity. Find:
 - i** the time elapsed before that instant
 - ii** the value of k
 - iii** the common velocity.

- 13** The position of an object is given by $\mathbf{r}(t) = e^t \mathbf{i} + 4e^{2t} \mathbf{j}$, $t \geq 0$.
- a** Show that the path of the particle is the graph of $f: [1, \infty) \rightarrow \mathbb{R}$, $f(x) = 4x^2$.
- b** Find:
- the velocity vector at time t
 - the initial velocity
 - the time at which the velocity is parallel to the vector $\mathbf{i} + 12\mathbf{j}$.
- 14** The velocity of a particle is given by $\dot{\mathbf{r}}(t) = (t - 3)\mathbf{j}$, $t \geq 0$.
- a** Show that the path of this particle is linear.
- b** Initially, the position of the particle is $2\mathbf{i} + \mathbf{j}$.
- Find the Cartesian equation of the path followed by the particle.
 - Find the point at which the particle is momentarily at rest.
- 15** A particle is moving such that its position vector, $\mathbf{r}(t)$, is given by
- $$\mathbf{r}(t) = 3 \sin(2\pi t) \mathbf{i} + 3 \cos(2\pi t) \mathbf{j}, \quad t \geq 0$$
- All distances are in metres and time is in seconds.
- a** Find the speed of the particle in m/s.
- b** Find the magnitude of the acceleration in m/s^2 .
- c** Find the position, velocity and acceleration vectors at time $t = 1$ second.
- d** Find the angular velocity of the particle in radians per second.



Multiple-choice questions



- 1** A particle moves in a plane such that, at time t , its position is $\mathbf{r}(t) = 2t^2 \mathbf{i} + (3t - 1)\mathbf{j}$. Its acceleration at time t is given by
- A** $4t \mathbf{i} + 3\mathbf{j}$ **B** $\frac{2}{3}t^3 \mathbf{i} + (\frac{3}{2}t^2 - t)\mathbf{j}$ **C** $4\mathbf{i} + 3\mathbf{j}$ **D** $0\mathbf{i} + 0\mathbf{j}$ **E** $4\mathbf{i} + 0\mathbf{j}$
- 2** The position vector of a particle at time t , $t \geq 0$, is given by $\mathbf{r} = \sin(3t)\mathbf{i} - 2\cos(t)\mathbf{j}$. The speed of the particle when $t = \pi$ is
- A** 2 **B** $2\sqrt{2}$ **C** $\sqrt{5}$ **D** 0 **E** 3
- 3** A particle moves with constant velocity $5\mathbf{i} - 4\mathbf{j} + 2\mathbf{k}$. Its initial position is $3\mathbf{i} - 6\mathbf{k}$. Its position vector at time t is given by
- A** $(3t + 5)\mathbf{i} - 4\mathbf{j} + (2 - 6t)\mathbf{k}$ **B** $(5t + 3)\mathbf{i} - 4t\mathbf{j} + (2t - 6)\mathbf{k}$
C $5t\mathbf{i} - 4t\mathbf{j} + 2t\mathbf{k}$ **D** $-5t\mathbf{i} - 4t\mathbf{j} + 2t\mathbf{k}$
E $(5t - 3)\mathbf{i} + (2t - 6)\mathbf{k}$
- 4** A particle moves with its position vector defined with respect to time t by the vector function $\mathbf{r}(t) = (2t^3 - 1)\mathbf{i} + (2t^2 + 3)\mathbf{j} + 6t\mathbf{k}$. The acceleration when $t = 1$ is given by
- A** $6\mathbf{i} + 4\mathbf{j} + 6\mathbf{k}$ **B** $12\mathbf{i} + 4\mathbf{j} + 6\mathbf{k}$ **C** $12\mathbf{i}$ **D** $2\sqrt{10}$ **E** $12\mathbf{i} + 4\mathbf{j}$

- 5** The position vector of a particle at time t seconds is $\mathbf{r}(t) = (t^2 - 4t)(\mathbf{i} - \mathbf{j} + \mathbf{k})$, measured in metres from a fixed point. The distance in metres travelled in the first 4 seconds is
A 0 **B** $4\sqrt{3}$ **C** $8\sqrt{3}$ **D** 4 **E** $\sqrt{3}$
- 6** The initial position, velocity and constant acceleration of a particle are given by $3\mathbf{i}$, $2\mathbf{j}$ and $2\mathbf{i} - \mathbf{j}$ respectively. The position vector of the particle at time t is given by
A $(2\mathbf{i} - \mathbf{j})t + 3\mathbf{i}$ **B** $t^2\mathbf{i} - \frac{1}{2}t^2\mathbf{j}$ **C** $(t^2 + 3)\mathbf{i} + (2t - \frac{1}{2}t^2)\mathbf{j}$
D $3\mathbf{i} + 2t\mathbf{j}$ **E** $\frac{1}{2}t^2(2\mathbf{i} - \mathbf{j})$
- 7** The position of a particle at time $t = 0$ is $\mathbf{r}(0) = \mathbf{i} - 5\mathbf{j} + 2\mathbf{k}$. The position of the particle at time $t = 3$ is $\mathbf{r}(3) = 7\mathbf{i} + 7\mathbf{j} - 4\mathbf{k}$. The average velocity for the interval $[0, 3]$ is
A $\frac{1}{3}(8\mathbf{i} + 2\mathbf{j} - 2\mathbf{k})$ **B** $\frac{1}{3}(21\mathbf{i} + 21\mathbf{j} - 12\mathbf{k})$ **C** $2\mathbf{i} + 4\mathbf{j} - 2\mathbf{k}$
D $\mathbf{i} + 2\mathbf{j} - \mathbf{k}$ **E** $2\mathbf{i} - \mathbf{j} + \mathbf{k}$
- 8** A particle is moving so its velocity vector at time t is $\dot{\mathbf{r}}(t) = 2t\mathbf{i} + 3\mathbf{j}$, where $\mathbf{r}(t)$ is the position vector at time t . If $\mathbf{r}(0) = 3\mathbf{i} + \mathbf{j}$, then $\mathbf{r}(t)$ is equal to
A $2\mathbf{i}$ **B** $(3t + 1)\mathbf{i} + (3t^2 + 1)\mathbf{j}$ **C** $2t^2\mathbf{i} + 3t\mathbf{j} + 3\mathbf{i} + \mathbf{j}$
D $5\mathbf{i} + 3\mathbf{j}$ **E** $(t^2 + 3)\mathbf{i} + (3t + 1)\mathbf{j}$
- 9** The velocity of a particle is given by the vector $\dot{\mathbf{r}}(t) = t\mathbf{i} + e^t\mathbf{j}$. At time $t = 0$, the position of the particle is given by $\mathbf{r}(0) = 3\mathbf{i}$. The position of the particle at time t is given by
A $\mathbf{r}(t) = \frac{1}{2}t^2\mathbf{i} + e^t\mathbf{j}$ **B** $\mathbf{r}(t) = \frac{1}{2}(t^2 + 3)\mathbf{i} + e^t\mathbf{j}$ **C** $\mathbf{r}(t) = (\frac{1}{2}t^2 + 3)\mathbf{i} + (e^t - 1)\mathbf{j}$
D $\mathbf{r}(t) = (\frac{1}{2}t^2 + 3)\mathbf{i} + e^t\mathbf{j}$ **E** $\mathbf{r}(t) = \frac{1}{2}(t^2 + 3)\mathbf{i} + (e^t - 1)\mathbf{j}$
- 10** A curve is described by the vector equation $\mathbf{r}(t) = 2\cos(\pi t)\mathbf{i} + 3\sin(\pi t)\mathbf{j}$. With respect to a set of Cartesian axes, the gradient of the curve at the point $(\sqrt{3}, 1.5)$ is
A $-\frac{\sqrt{3}}{2}$ **B** $-(\pi\mathbf{i} + 3\sqrt{3}\pi\mathbf{j})$ **C** $\pi\mathbf{i} + 3\sqrt{3}\pi\mathbf{j}$ **D** $-\frac{3\sqrt{3}}{2}\pi$ **E** $-\frac{3\sqrt{3}}{2}$
- 11** An object is projected horizontally from the top of an 80 m high cliff, and strikes the ground 1330 m from the base of the cliff. The object's initial speed is closest to
A 4 m/s **B** 9.8 m/s **C** 82 m/s **D** 170 m/s **E** 330 m/s
- 12** A particle is moving at a constant speed of 6 m/s around a circle centred at the origin. The acceleration is given by $\ddot{\mathbf{r}} = -9\mathbf{r}$, where \mathbf{r} is the position of the particle at time t seconds. The period of the motion, T s, and radius of the circle, r m, are given by
A $T = \frac{2\pi}{3}$, $r = 6$ **B** $T = 3$, $r = 6$ **C** $T = \frac{2\pi}{3}$, $r = 4$
D $T = 6\pi$, $r = 9$ **E** $T = \frac{2\pi}{3}$, $r = 2$



Extended-response questions

- 1** Two particles P and Q are moving in a horizontal plane. The particles are moving with velocities $9\mathbf{i} + 6\mathbf{j}$ m/s and $5\mathbf{i} + 4\mathbf{j}$ m/s respectively.
- Determine the speeds of the particles.
 - At time $t = 4$, particles P and Q have position vectors $\mathbf{r}_P(4) = 96\mathbf{i} + 44\mathbf{j}$ and $\mathbf{r}_Q(4) = 100\mathbf{i} + 96\mathbf{j}$. (Distances are measured in metres.)
 - Find the position vectors of P and Q at time $t = 0$.
 - Find the vector \overrightarrow{PQ} at time t .
 - Find the time at which P and Q are nearest to each other and the magnitude of \overrightarrow{PQ} at this instant.
- 2** Two particles A and B move in the plane. The velocity of A is $(-3\mathbf{i} + 29\mathbf{j})$ m/s while that of B is $v(\mathbf{i} + 7\mathbf{j})$ m/s, where v is a constant. (All distances are measured in metres.)
- Find the vector \overrightarrow{AB} at time t seconds, given that when $t = 0$, $\overrightarrow{AB} = -56\mathbf{i} + 8\mathbf{j}$.
 - Find the value of v such that the particles collide.
 - If $v = 3$:
 - Find \overrightarrow{AB} .
 - Find the time when the particles are closest.
- 3** A child is sitting still in some long grass watching a bee. The bee flies at a constant speed in a straight line from its beehive to a flower and reaches the flower 3 seconds later. The position vector of the beehive relative to the child is $10\mathbf{i} + 2\mathbf{j} + 6\mathbf{k}$ and the position vector of the flower relative to the child is $7\mathbf{i} + 8\mathbf{j}$, where all the distances are measured in metres.
- If B is the position of the beehive and F the position of the flower, find \overrightarrow{BF} .
 - Find the distance BF .
 - Find the speed of the bee.
 - Find the velocity of the bee.
 - Find the time when the bee is closest to the child and its distance from the child at this time.
- 4** Initially, a motor boat is at a point J at the end of a jetty and a police boat is at a point P . The position vector of P relative to J is $400\mathbf{i} - 600\mathbf{j}$. The motor boat leaves the point J and travels with constant velocity $6\mathbf{i}$. At the same time, the police boat leaves its position at P and travels with constant velocity $u(8\mathbf{i} + 6\mathbf{j})$, where u is a real number. All distances are measured in metres and all times are measured in seconds.
- If the police boat meets the motor boat after t seconds, find:
 - the value of t
 - the value of u
 - the speed of the police boat
 - the position of the point where they meet.
 - Find the time at which the police boat was closest to J and its distance from J at this time.

- 5** A particle A is at rest on a smooth horizontal table at a point with position vector $-\mathbf{i} + 2\mathbf{j}$, relative to an origin O . Point B is on the table such that $\vec{OB} = 2\mathbf{i} + \mathbf{j}$. (All distances are measured in metres and time in seconds.) At time $t = 0$, the particle is projected along the table with velocity $(6\mathbf{i} + 3\mathbf{j})$ m/s.
- a** Determine:
- \vec{OA} at time t
 - \vec{BA} at time t .
- b** Find the time when $|\vec{BA}| = 5$.
- c** Using the time found in **b**:
- Find a unit vector \mathbf{c} along \vec{BA} .
 - Find a unit vector \mathbf{d} perpendicular to \vec{BA} .
Hint: The vector $y\mathbf{i} - x\mathbf{j}$ is perpendicular to $x\mathbf{i} + y\mathbf{j}$.
 - Express $6\mathbf{i} + 3\mathbf{j}$ in the form $p\mathbf{c} + q\mathbf{d}$.
- 6** **a** Sketch the graph of the Cartesian relation corresponding to the vector equation
- $$\mathbf{r}(\theta) = \cos(\theta)\mathbf{i} - \sin(\theta)\mathbf{j}, \quad 0 < \theta < \frac{\pi}{2}$$
- b** A particle P describes a circle of radius 16 cm about the origin. It completes the circle every π seconds. At $t = 0$, P is at the point $(16, 0)$ and is moving in a clockwise direction. It can be shown that $\vec{OP} = a \cos(nt)\mathbf{i} + b \sin(nt)\mathbf{j}$. Find the values of:
- a
 - b
 - n
 - State the velocity and acceleration of P at time t .
- c** A second particle Q has position vector given by $\vec{OQ} = 8 \sin(t)\mathbf{i} + 8 \cos(t)\mathbf{j}$, where measurements are in centimetres. Obtain an expression for:
- \vec{PQ}
 - $|\vec{PQ}|^2$
- d** Find the minimum distance between P and Q .
- 7** At time t , a particle has velocity $\mathbf{v} = (2 \cos t)\mathbf{i} - (4 \sin t \cos t)\mathbf{j}$, $t \geq 0$. At time $t = 0$, it is at the point with position vector $3\mathbf{j}$.
- Find the position of the particle at time t .
 - Find the position of the particle when it first comes to rest.
 - Find the Cartesian equation of the path of the particle.
 - Sketch the path of the particle.
 - Express $|\mathbf{v}|^2$ in terms of $\cos t$ and, without using calculus, find the maximum speed of the particle.
 - Give the time at which the particle is at rest for the second time.
 - Show that the distance, d , of the particle from the origin at time t is given by $d^2 = \cos^2(2t) + 2 \cos(2t) + 6$.
 - Find the time(s) at which the particle is closest to the origin.

- 8** A golfer hits a ball from a point referred to as the origin with a velocity of $a\mathbf{i} + b\mathbf{j} + 20\mathbf{k}$, where \mathbf{i} , \mathbf{j} and \mathbf{k} are unit vectors horizontally forwards, horizontally to the right and vertically upwards respectively. After being hit, the ball is subject to an acceleration $2\mathbf{j} - 10\mathbf{k}$. (All distances are measured in metres and all times in seconds.) Find:
- the velocity of the ball at time t
 - the position vector of the ball at time t
 - the time of flight of the ball
 - the values of a and b if the golfer wishes to hit a *direct* hole-in-one, where the position vector of the hole is $100\mathbf{i}$
 - the angle of projection of the ball if a hole-in-one is achieved.

- 9** Particles P and Q have variable position vectors \mathbf{p} and \mathbf{q} respectively, given by

$$\mathbf{p}(t) = \cos(t)\mathbf{i} + \sin(t)\mathbf{j} - \mathbf{k}$$

$$\mathbf{q}(t) = \cos(2t)\mathbf{i} - \sin(2t)\mathbf{j} + \frac{1}{2}\mathbf{k}$$

where $0 \leq t \leq 2\pi$.

- For $\mathbf{p}(t)$, describe the path.
 - Find the distance of particle P from the origin at time t .
 - Find the velocity of particle P at time t .
 - Show that the vector $\cos(t)\mathbf{i} + \sin(t)\mathbf{j}$ is perpendicular to the velocity vector of P for any value of t .
 - Find the acceleration, $\ddot{\mathbf{p}}(t)$, at time t .
 - Find the vector \overrightarrow{PQ} at time t .
 - Show that the distance between P and Q at time t is $\sqrt{\frac{17}{4} - 2\cos(3t)}$.
 - Find the maximum distance between the particles.
 - Find the times at which this maximum occurs.
 - Find the minimum distance between the particles.
 - Find the times at which this minimum occurs.
 - Show that $\mathbf{p}(t) \cdot \mathbf{q}(t) = \cos(3t) - \frac{1}{2}$.
 - Find an expression for $\cos(\angle POQ)$.
 - Find the greatest magnitude of angle POQ .
- 10** A golfer hits a ball from an origin, O , aiming at a hole, H , which is 200 metres away at the end of a horizontal fairway. The initial velocity of the ball is $\mathbf{v}(0) = 35\mathbf{i} + 5\mathbf{j} + 24.5\mathbf{k}$, where the unit vectors \mathbf{i} , \mathbf{j} and \mathbf{k} are chosen such that \mathbf{i} is in the direction of \overrightarrow{OH} and \mathbf{k} is in the upwards direction. The ball lands on the fairway at point L . While in the air, the ball is subject only to gravity, so its acceleration is $\mathbf{a}(t) = -9.8\mathbf{k} \text{ m/s}^2$.
- Find the position vector of the ball at time t seconds after being hit.
 - Find the length of time, in seconds, that the ball is in the air.
 - Find the distance, to the nearest metre, along the fairway from L to H .
 - Correct to one decimal place, find the speed of the ball in m/s when it lands.

- 11** Particles A and B move such that, at any time $t \geq 0$, their position vectors are $\mathbf{r}_A = 2t\mathbf{i} + t\mathbf{j}$ and $\mathbf{r}_B = (4 - 4\sin(\alpha t))\mathbf{i} + 4\cos(\alpha t)\mathbf{j}$, where α is a positive constant.
- Find the speed of B in terms of α .
 - Find the Cartesian equations of the paths of A and B .
 - On the same set of axes, sketch the paths of A and B , showing directions of travel.
 - Find the coordinates of the points where the paths of A and B cross.
 - Find the least value of α , correct to two decimal places, for which particles A and B will collide.

- 12** A bartender slides a glass along a bar for a customer to collect. Unfortunately, the customer has turned to speak to a friend. The glass slides over the edge of the bar with a horizontal velocity of 2 m/s. Assume that air resistance is negligible and that the acceleration due to gravity is 9.8 m/s^2 in a downwards direction.

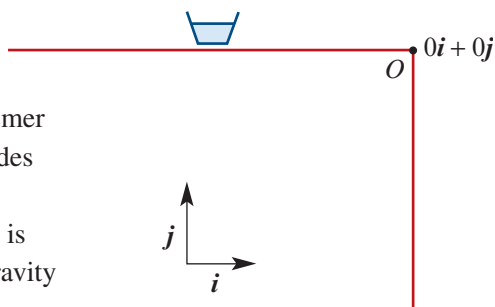

- Give the acceleration of the glass as a vector expression.
 - Give the vector expression for the velocity of the glass at time t seconds, where t is measured from when the glass leaves the bar.
 - Give the position of the glass with respect to the edge of the bar, O , at time t seconds.
- It is 0.8 m from O to the floor directly below. Find:
 - the time it takes for the glass to hit the floor
 - the horizontal distance from the bar where the glass hits the floor.

- 13** A yacht is returning to its marina at O . At noon, the yacht is at Y . The yacht takes a straight-line course to O . Point L is the position of a navigation sign on the shore. Coordinates represent distances east and north of the marina, measured in kilometres.

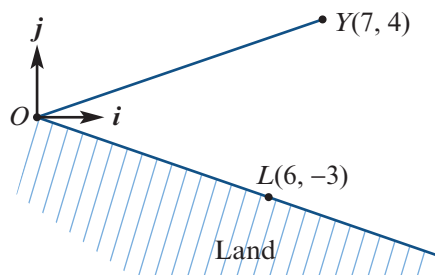

- Write down the position vector of the navigation sign L .
 - Find the unit vector in the direction of \vec{OL} .
- Find the vector resolute of \vec{OY} in the direction of \vec{OL} and hence find the coordinates of the point on shore closest to the yacht at noon.
- The yacht sails towards O . The position vector at time t hours after 12 p.m. is given by $\mathbf{r}(t) = (7 - \frac{7}{2}t)\mathbf{i} + (4 - 2t)\mathbf{j}$.
 - Find an expression for \vec{LP} , where P is the position of the yacht at time t .
 - Find the time when the yacht is closest to the navigation sign.
 - Find the closest distance between the sign and the yacht.



Dynamics

Objectives

- ▶ To understand and use the definitions of:
 - ▷ mass
 - ▷ weight
 - ▷ force
 - ▷ resultant force
 - ▷ momentum.
- ▶ To apply **Newton's three laws of motion**.
- ▶ To apply resolution of vectors to problems involving force.
- ▶ To apply calculus to problems involving variable force.
- ▶ To consider the case of **equilibrium**, i.e. when the acceleration is zero.
- ▶ To apply vector function techniques.

The aim of theoretical dynamics is to provide a quantitative prediction of the motion of objects. In other words, to construct a mathematical model for **motion**. The practical applications of such models are obvious. In this chapter, we consider motion in a straight line only.

The Greeks were the first to record a theoretical basis for this subject. Archimedes wrote on the subject in the third century BC, and this study was advanced by many others. Many of the great mathematicians of the seventeenth to nineteenth centuries worked on dynamics. These include Isaac Newton (1642–1727), whose work provides the material for much of this chapter, Leonhard Euler (1707–1783) and Joseph-Louis Lagrange (1736–1813).

17A Force

Force is a word in common usage, and most people have an intuitive idea of its meaning. When a piano or some other object is pushed across the floor, this is done by exerting some force on the piano. A body falls because of the gravitational force exerted on it by the Earth.

We consider different types of forces in the next section. We start with a discussion of some key concepts for the study of dynamics.

► Particle model

In this chapter, we use a **particle model**. This means that an object is considered as a point. This can be done when the size of the object can be neglected in comparison with other lengths in the problem being considered, or when rotational motion effects can be ignored.

► Measurements

The mks system

The description of motion is dependent on the measurement of length, mass and time. In this chapter, the principal unit of:

- length will be the metre
- mass will be the kilogram
- time will be the second.

Other units will occur, but it is often advisable to convert these to metres, kilograms and seconds. This system of units is called the mks system.

Note: The **mass** of an object is the amount of matter that it contains. The measurement of the mass of an object does not depend on its position. In mathematics, the terms *mass* and *weight* do not have the same meaning.

Vector and scalar quantities

We have studied vectors and scalars in Chapters 5, 6 and 16.

Length, mass and time are **scalar quantities**: they are specified by their magnitude only.

Position, displacement, velocity and acceleration are **vector quantities**: they must be specified by both magnitude and direction.

Units of force

One unit of force is the **kilogram weight** (kg wt). If an object on the surface of the Earth has a mass of 1 kg, then the gravitational force acting on the object is 1 kg wt.

The standard unit of force is the **newton** (N). The conversion is $1 \text{ kg wt} = g \text{ N}$, where $g \text{ m/s}^2$ is the acceleration due to gravity. The significance of this unit will be discussed in the next section.

► Resultant force

Force is a vector quantity. The vector sum of the forces acting at a point is called the **resultant force**.

Example 1

Find the magnitude and direction of the resultant force of the forces 3 N and 5 N acting on a particle at O as shown in this diagram.

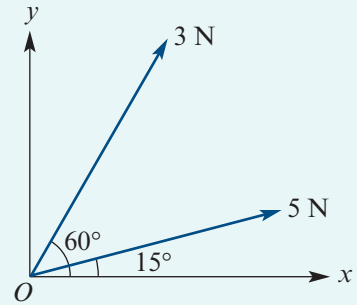

Solution

Method 1

The resultant force, \mathbf{R} , is given by the vector sum. The angle OAB has magnitude 135° .

Using the cosine rule:

$$\begin{aligned} |\mathbf{R}|^2 &= 3^2 + 5^2 - 2 \times 3 \times 5 \cos 135^\circ \\ &= 9 + 25 - 30 \cos 135^\circ \\ &= 34 + 30 \times \frac{1}{\sqrt{2}} \\ &= 34 + 15\sqrt{2} \end{aligned}$$

$$\therefore |\mathbf{R}| \approx 7.43 \text{ N}$$

The magnitude of the resultant force is 7.43 N, correct to two decimal places.

To describe the direction of the vector, we will find the angle θ° between the vector and the positive direction of the x -axis.

$$\text{Let } \angle AOB = (60 - \theta)^\circ.$$

Then

$$\begin{aligned} \frac{|\mathbf{R}|}{\sin 135^\circ} &= \frac{5}{\sin(60 - \theta)^\circ} \\ \sin(60 - \theta)^\circ &= \frac{5 \sin 135^\circ}{|\mathbf{R}|} \\ &= 0.4758 \dots \end{aligned}$$

$$\therefore \theta = 31.59^\circ \quad \text{correct to two decimal places}$$

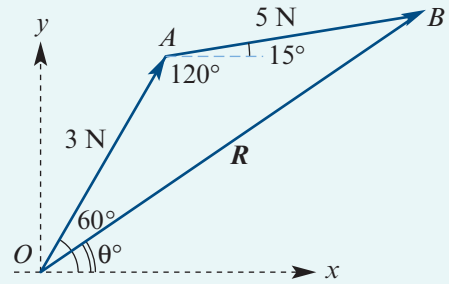

Method 2

The problem can also be completed by expressing each of the vectors in i - j notation.

The vector of magnitude 3 N in component form is

$$3 \cos 60^\circ \mathbf{i} + 3 \sin 60^\circ \mathbf{j}$$

The vector of magnitude 5 N in component form is

$$5 \cos 15^\circ \mathbf{i} + 5 \sin 15^\circ \mathbf{j}$$

The sum is $(6.3296 \dots)\mathbf{i} + (3.8921 \dots)\mathbf{j}$.

The magnitude of the resultant is 7.43 N, correct to two decimal places.

Determine the direction:

$$\tan \theta^\circ = \frac{3.8921 \dots}{6.3296 \dots}$$

$$\theta = 31.5879 \dots$$

The resultant force is 7.43 N acting in the direction 31.59° anticlockwise from the x -axis.

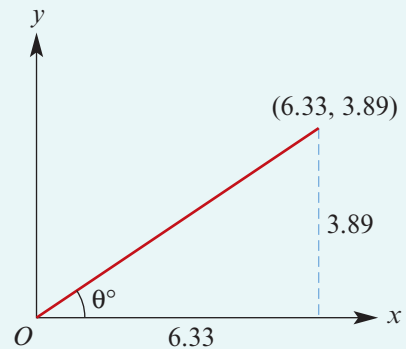
**Example 2**

- a** Four forces are acting on a particle as shown. Express the resultant force in i - j form.
- b** Give the magnitude of the resultant force and the angle that it makes with the i -direction.

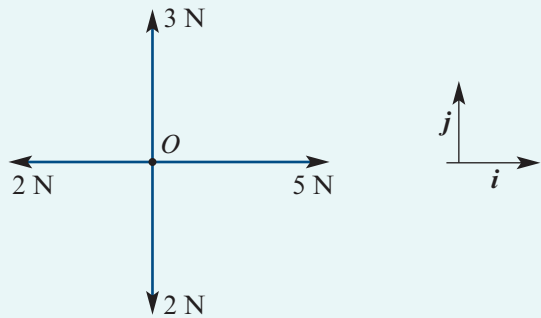
**Solution**

a Resultant force $= (5 - 2)\mathbf{i} + (3 - 2)\mathbf{j}$
 $= (3\mathbf{i} + \mathbf{j})$ N

b Magnitude of the force $= \sqrt{3^2 + 1^2}$
 $= \sqrt{10}$

The angle with the i -direction is given by

$$\tan \theta = \frac{1}{3}$$

$$\therefore \theta = 18.43^\circ$$

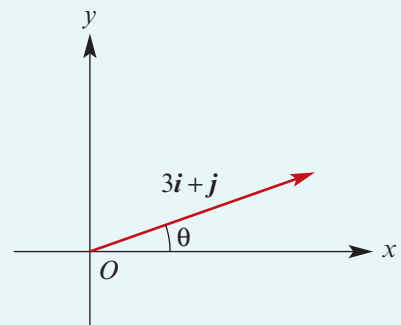

► Resolution of a force in a given direction

Consider a model railway trolley, set on smooth straight tracks, pulled by a force of magnitude P N along a horizontal string which makes an angle θ with the direction of the track. (The plan view is shown in the diagram.)

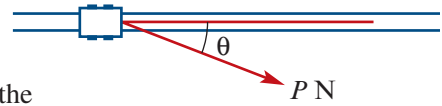

- When $\theta = 0^\circ$, the trolley moves along the track.
- As θ increases, the trolley still moves along the track, but the same force will have a decreasing effect on its motion, i.e. the acceleration of the trolley will be less.
- When $\theta = 90^\circ$, the trolley stays in equilibrium, i.e. if at rest it will not move, unless the force is strong enough to cause it to topple sideways.

A force acting on a body has an influence in directions other than its line of action, except the direction perpendicular to its line of action.

Let the force of P N be represented by the vector p .

Let a be the resolute of p in the \overrightarrow{OX} direction and let b be the perpendicular resolute.

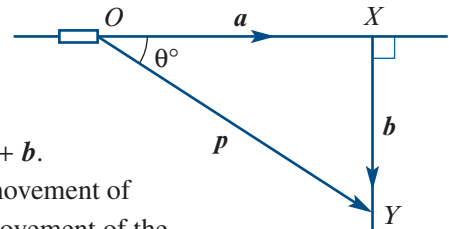

From the triangle of vectors, it can be seen that $p = a + b$.

As the force represented by b does not influence the movement of the trolley along the track, the net effect of P on the movement of the trolley in the direction of the track is a . The force represented by a is the resolved part of the force P in the direction of \overrightarrow{OX} .

Resolution of a force

The resolved part of a force of P N in a direction which makes an angle θ with its own line of action is a force of magnitude $P \cos \theta$.

Note: The resolved part is also called the **component** of the force in the given direction.

Example 3

Find the resolved part of each of the following forces in the direction of \overrightarrow{EF} :

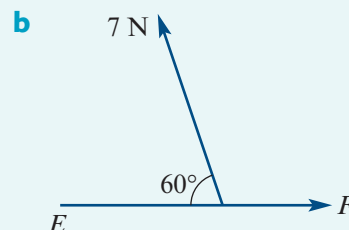
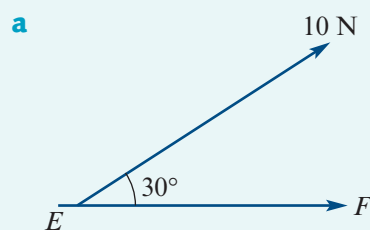

Solution

- a** Resolved part is $10 \cos 30^\circ = 5\sqrt{3}$ N. **b** Resolved part is $7 \cos 120^\circ = -3.5$ N.

Example 4

Find the component of the force $\mathbf{F} = (3\mathbf{i} + 2\mathbf{j})$ N in the direction of the vector $2\mathbf{i} - \mathbf{j}$.

Solution

Let $\mathbf{a} = 2\mathbf{i} - \mathbf{j}$. The unit vector in the direction of \mathbf{a} is $\hat{\mathbf{a}} = \frac{1}{\sqrt{5}}(2\mathbf{i} - \mathbf{j})$.

$$\text{Thus } \mathbf{F} \cdot \hat{\mathbf{a}} = (3\mathbf{i} + 2\mathbf{j}) \cdot \frac{1}{\sqrt{5}}(2\mathbf{i} - \mathbf{j}) = \frac{1}{\sqrt{5}}(6 - 2) = \frac{4}{\sqrt{5}}$$

$$\text{and } (\mathbf{F} \cdot \hat{\mathbf{a}})\hat{\mathbf{a}} = \frac{4}{\sqrt{5}} \times \frac{1}{\sqrt{5}}(2\mathbf{i} - \mathbf{j}) = \frac{4}{5}(2\mathbf{i} - \mathbf{j})$$

The component of \mathbf{F} in the direction of $2\mathbf{i} - \mathbf{j}$ is $\frac{4}{5}(2\mathbf{i} - \mathbf{j})$ N.

Example 5

Forces of 5 N, 3 N and 2 N act at a point as shown in the diagram. Find:

- the magnitude of the resultant of these forces
- the direction of the resultant force with respect to the 5 N force.

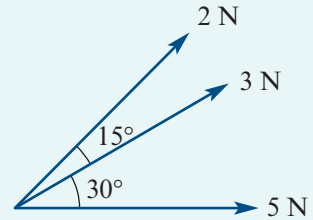
**Solution**

- Let \mathbf{i} be in the direction of the 5 N force.

The sum of the resolved parts in the direction of the 5 N force is

$$\begin{aligned} & (5 + 3 \cos 30^\circ + 2 \cos 45^\circ)\mathbf{i} \\ & = 9.01\mathbf{i} \text{ N correct to two decimal places} \end{aligned}$$

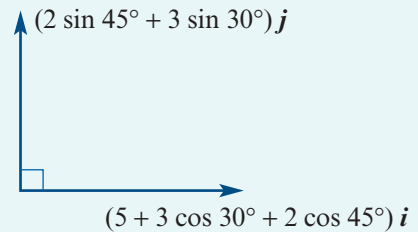

The sum of the resolved parts in the direction perpendicular to the 5 N force is

$$\begin{aligned} & (2 \sin 45^\circ + 3 \sin 30^\circ)\mathbf{j} \\ & = 2.91\mathbf{j} \text{ N correct to two decimal places} \end{aligned}$$

Therefore the magnitude of the resultant force is $\sqrt{9.01^2 + 2.91^2} = 9.47$ N.

- Let θ be the angle that the resultant force makes with the 5 N force. Then

$$\tan \theta = \frac{2.91}{9.01}$$

$$\therefore \theta = 17.9^\circ$$

The resultant force of 9.47 N is inclined at an angle of 17.9° to the 5 N force.

The vector diagram for the resultant is shown here.

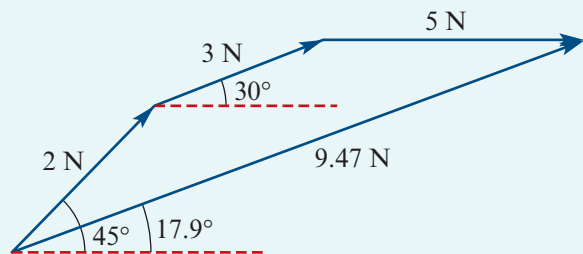

Exercise 17A

Example 2

1 Let \mathbf{i} be the unit vector in the positive direction of the x -axis and \mathbf{j} be the unit vector in the positive direction of the y -axis. For each of the following, find:

- i** the resultant force using \mathbf{i} - \mathbf{j} notation
- ii** the magnitude and direction of the resultant force. (The angle is measured anticlockwise from the \mathbf{i} -direction.)

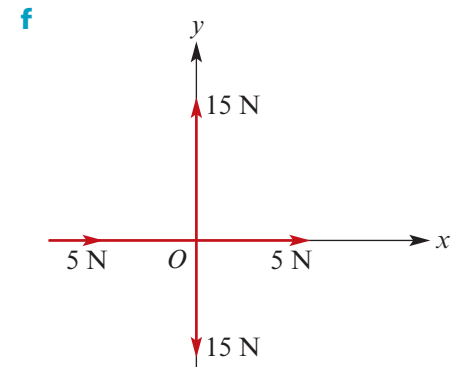
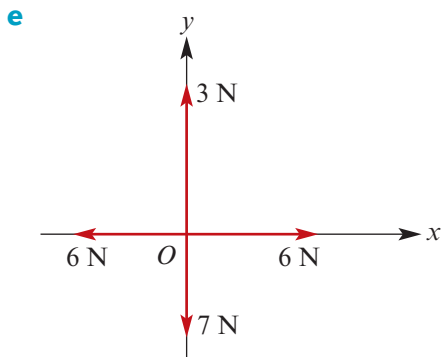
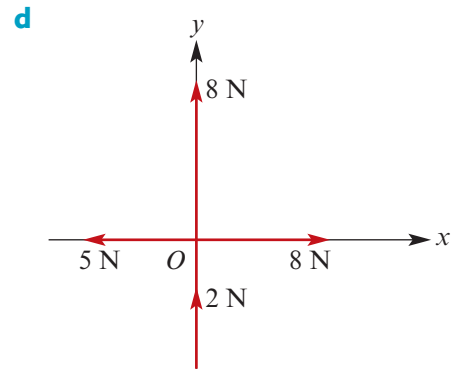
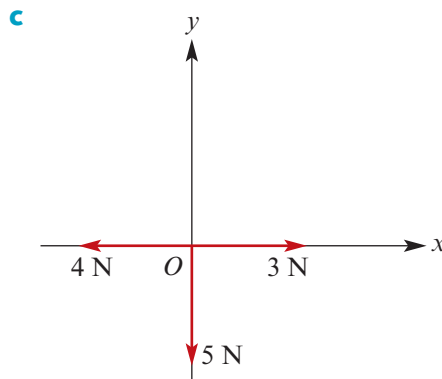
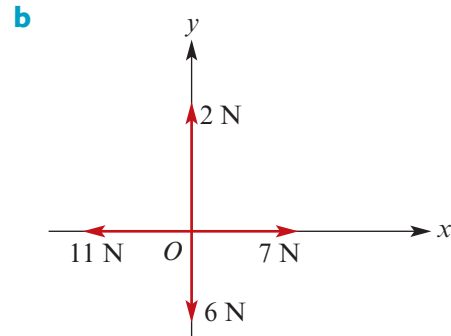
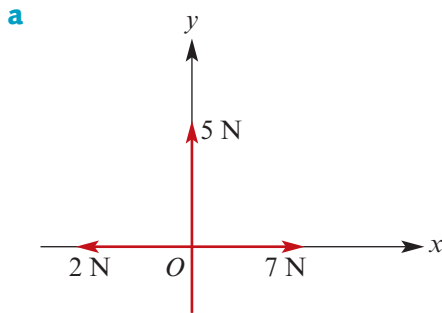

2 The forces $F_1 = (3\mathbf{i} + 2\mathbf{j})$ N, $F_2 = (6\mathbf{i} - 4\mathbf{j})$ N and $F_3 = (2\mathbf{i} - \mathbf{j})$ N act on a particle. Find the resultant force acting on the particle.

Example 1 3 Find the magnitude of F , the resultant force of the 16 N and 12 N forces.

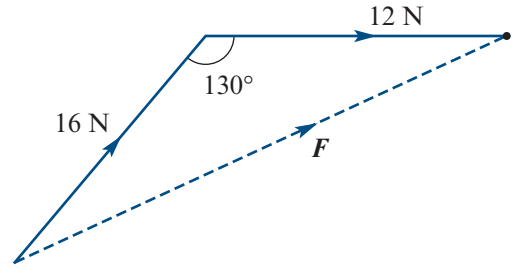

4 $R = F_1 + F_2$
 $|R| = 16$ N and $|F_1| = 9$ N
 Find $|F_2|$.

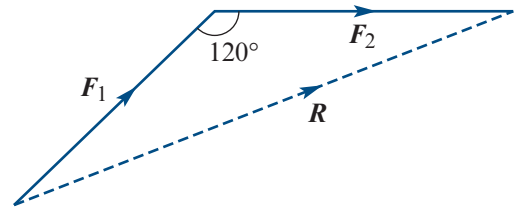

5 $F_1 + F_2 + F_3 = F$ and $F = (3i - 2j + k)$ N, $F_1 = (2i - j + k)$ N and $F_2 = (3i - j - k)$ N.
 Find F_3 .

Example 3 6 A tractor is pulling a barge along a canal with a force of 400 N. The barge is moving parallel to the bank. Find the component of F in the direction of motion.

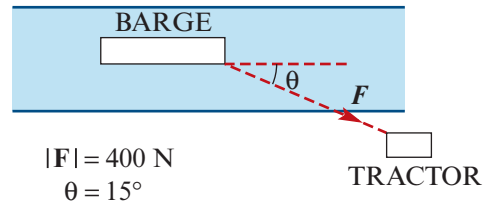

7 Let i be the unit vector in the positive direction of the x -axis and j be the unit vector in the positive direction of the y -axis. For each of the following, find:

- i the resultant force using i - j notation
- ii the magnitude and direction of the resultant force. (The angle is measured anticlockwise from the i -direction.)

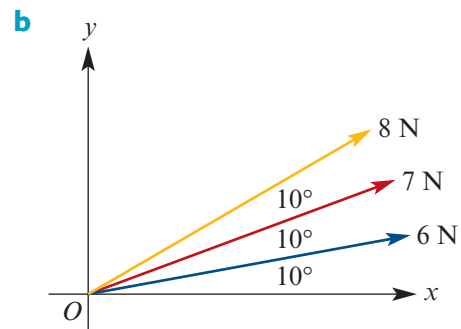
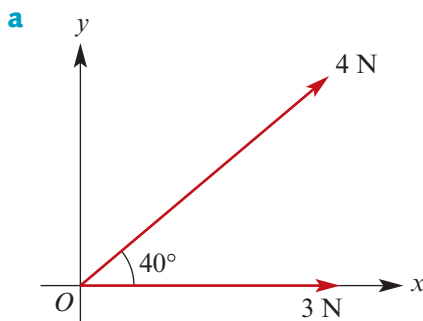

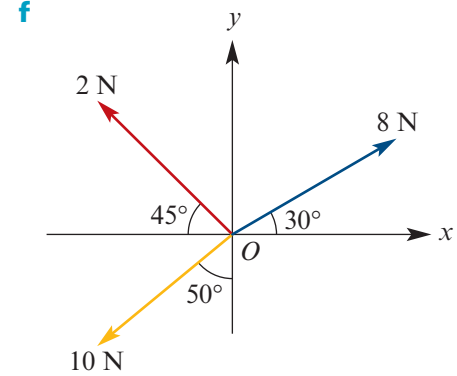
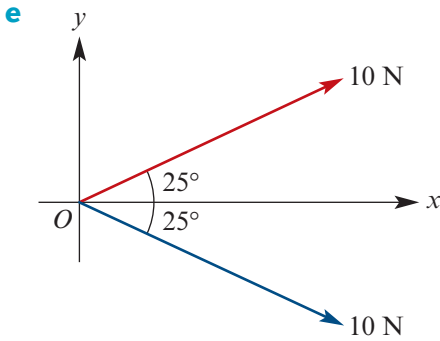
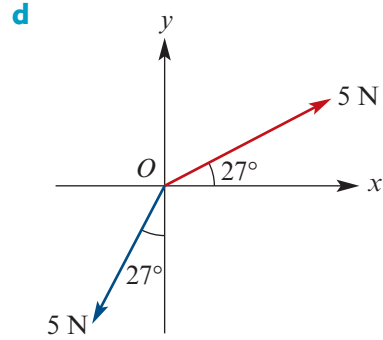
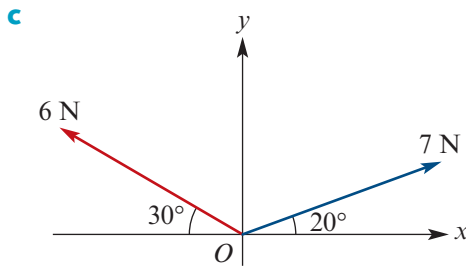

- 8** For each of the diagrams **a**, **c** and **e** of Question 7, find the resultant force using a triangle of forces.
- 9** Three forces are acting at the origin in the directions of the coordinate points as shown in the diagram.

- a** Find the resultant force.
- b** Find the magnitude and direction of the resultant force.

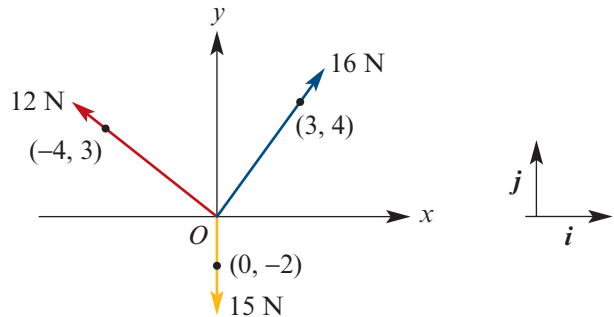

- 10** Find the resolved part of each of the following forces in the direction of \vec{EF} :

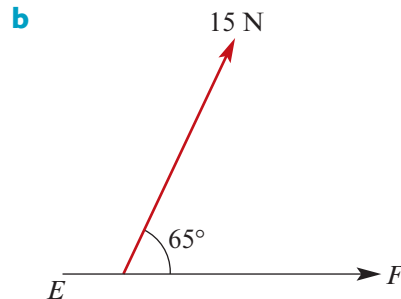
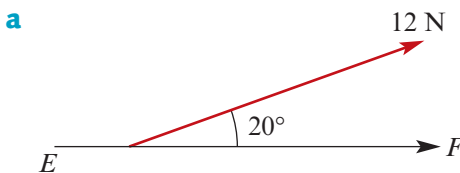

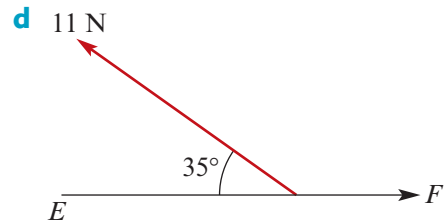
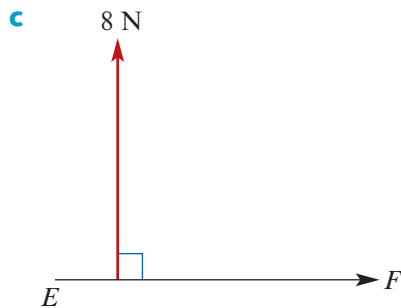

11 Two forces act on a particle as shown in the diagram.

- a** Find the sum of the resolved parts of the forces in the direction of \vec{EF} .
- b** Find the sum of the resolved parts of the forces in the direction of the 8 N force.

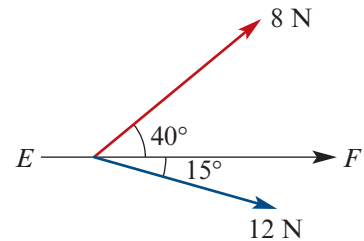

- Example 4** **12** **a** Find the component of the force $(7\mathbf{i} + 3\mathbf{j})$ N in the direction of the vector $2\mathbf{i} - \mathbf{j}$.
- b** Find the component of the force $(2\mathbf{i} - 3\mathbf{j})$ N in the direction of the vector $3\mathbf{i} + 4\mathbf{j}$.

13 Three forces act on a particle as shown in the diagram.

Find the sum of the resolved parts of the forces in the direction of:

- a** the 8 N force
- b** the 10 N force
- c** the 11 N force.

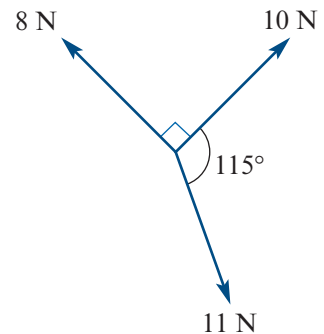

14 Find the sum of the resolved parts of the forces in the direction of \vec{EF} in this diagram.

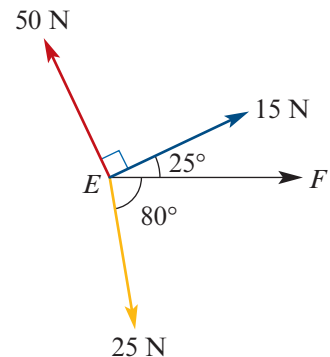

15 A frame is in the shape of a right-angled triangle ABC , where $AB = 6.5$ m, $BC = 6$ m and $AC = 2.5$ m. A force of 10 N acts along \vec{BC} and a force of 24 N acts along \vec{BA} . Find the sum of the resolved parts of the two forces in the direction of:

- a** \vec{BC} **b** \vec{BA}

Example 5 **16** Find the magnitude and direction with respect to \vec{OX} of the resultant of the following forces:

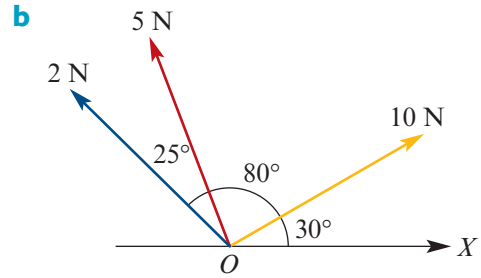
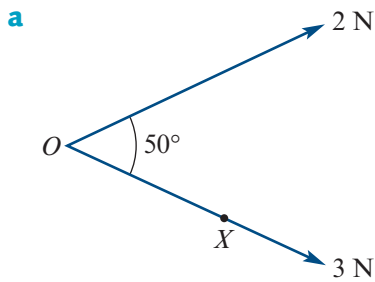

17 Find the magnitude of the resultant of two forces of 7 N and 10 N acting at an angle of 50° to each other.

18 The angles between the forces of magnitude 8 N, 10 N and P N are 60° and 90° respectively. The resultant acts along the 10 N force. Find:

a P **b** the magnitude of the resultant.

19 Three forces 5 N, 7 N and P N act on a particle at O . Find the value of P that will produce a resultant force along \vec{OX} if the line of action of the P N force is perpendicular to OX .

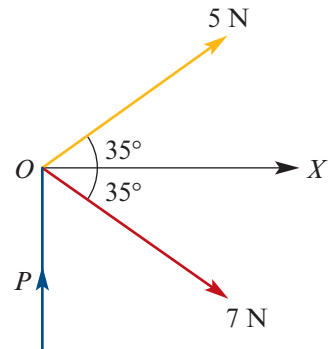

17B Newton's laws of motion

► Weight

The gravitational force per unit mass due to the Earth is g newtons per kilogram. It varies from place to place on the Earth's surface, having a value of 9.8321 at the poles and 9.7799 at the equator.

In this book, the value 9.8 will be assumed for g , unless otherwise stated.

A mass of m kg on the Earth's surface has a force of m kg wt = mg N acting on it. This force is known as the **weight**.

► Momentum

The **momentum** of a particle is defined as the product of its mass and velocity:

$$\text{momentum} = \text{mass} \times \text{velocity}$$

Let \mathbf{v} be the velocity of the particle and m the mass. The momentum, \mathbf{P} , is a vector quantity. It has the same direction as the velocity:

$$\mathbf{P} = m\mathbf{v}$$

The units of momentum are kg m/s or kg ms⁻¹.

For example, the momentum of an object of mass 3 kg moving at 2 m/s is 6 kg m/s.

Momentum can be considered as the fundamental quantity of motion.

Example 6

- a Find the momentum of a particle of mass 6 kg moving with velocity $(3\mathbf{i} + 4\mathbf{j})$ m/s.
- b Find the momentum of a 12 kg particle moving with a velocity of 8 m/s in an easterly direction.

Solution

- a Momentum = $6(3\mathbf{i} + 4\mathbf{j})$ kg m/s
- b Momentum = 96 kg m/s in an easterly direction

The **change of momentum** is central to Newton's second law of motion. Its importance is introduced through the following example.

Example 7

Find the change in momentum of a ball of mass 0.5 kg if the velocity changes from 5 m/s to 2 m/s. The ball is moving in the one direction in a straight line.

Solution

$$\text{Initial momentum} = 0.5 \times 5 = 2.5 \text{ kg m/s}$$

$$\text{Final momentum} = 0.5 \times 2 = 1 \text{ kg m/s}$$

$$\text{Change in momentum} = 1 - 2.5 = -1.5 \text{ kg m/s}$$

Newton used this idea of change of momentum to give a formal definition of force. In the example, the resistance force has changed the velocity from 5 m/s to 2 m/s.

We shall see that, in Newton's second law of motion, the rate of change of momentum with respect to time is used to define force.

► Newton's three laws of motion

Dynamics is based on Newton's laws of motion, which can be stated as follows.

1 Newton's first law of motion

A particle remains stationary, or in uniform straight-line motion (i.e. in a straight line with constant velocity), unless acted on by some overall external force, i.e. if the resultant force is zero.

2 Newton's second law of motion

A particle acted on by forces whose resultant is not zero will move in such a way that the rate of change of its momentum with respect to time will at any instant be proportional to the resultant force.

3 Newton's third law of motion

If a particle A exerts a force on a second particle B , then B exerts a collinear force of equal magnitude and opposite direction on A .

Implications of Newton's first law of motion

- A force is needed to start an object moving (or to stop it), but once moving the object will continue at a constant velocity without any force being needed.
- If an object is at rest or in uniform straight-line motion, then any forces acting on the object must balance – that is, the resultant force is zero.
- If motion is changing (in speed or direction), then the forces cannot balance – that is, the resultant force is non-zero.

Implications of Newton's second law of motion

Let F represent the resultant force exerted on an object of mass m kg moving at a velocity v m/s in a straight line. Then

$$F = k \frac{d}{dt}(mv)$$

Assuming that the mass is a constant:

$$F = km \frac{d}{dt}(v) = kma$$

The newton is the unit of force chosen so that the constant k is equal to 1 when the mass is measured in kilograms and the acceleration in m/s^2 . That is, one **newton** is the force which causes a change of momentum of 1 kg m/s per second.

Newton's second law of motion

When measuring force in newtons, mass in kilograms and acceleration in m/s^2 , the formula can be written as

$$F = ma$$

Note: The directions of the acceleration and the resultant force are the same.

Example 8

A stone of mass 16 grams is acted on by a force of 0.6 N. What will be its acceleration?

Solution

First convert to standard units: $16 \text{ g} = 0.016 \text{ kg}$.

Use the formula $F = ma$:

$$0.6 = 0.016a$$

$$\therefore a = 37.5$$

The acceleration is 37.5 m/s^2 .

Note: Force is a vector quantity, but it is often useful to employ only the magnitude of a force in calculations, and the direction is evident from the context.
In the remainder of this chapter, and in particular in diagrams, we often denote the magnitude of a force (for example, F) by the same unbolded letter (in this case, F).

**Example 9**

An ice-hockey puck of mass 150 grams loses speed from 26 m/s to 24 m/s over a distance of 35 m. Find the uniform force which causes this change in velocity. How much further could the puck travel?

Solution

The retarding force is uniform. Therefore $a = k$, where k is a constant.

Using $a = v \frac{dv}{dx}$ and separation of variables, we obtain $\frac{1}{2}v^2 = kx + c$.

When $t = 0$, $v = 26$ and $x = 0$. Therefore $c = \frac{26^2}{2}$.

When $x = 35$, $v = 24$:

$$\frac{24^2}{2} = 35k + \frac{26^2}{2}$$

$$\therefore k = \frac{-10}{7}$$

Thus the uniform force that is acting is

$$F = ma = 0.15 \times \left(\frac{-10}{7}\right) = -\frac{3}{14} \text{ N}$$

When $v = 0$:

$$kx + c = 0$$

$$\therefore x = \frac{-26^2}{2} \times \left(\frac{-7}{10}\right) = 236.6 \text{ m}$$

The puck would travel a further 201.6 m before coming to rest.

Note: Alternatively, we could have used the formula for constant acceleration $v^2 = u^2 + 2as$.

Example 10

Three forces F_1 , F_2 and F_3 act on a particle of mass 2 kg, where $F_1 = (2\mathbf{i} - 3\mathbf{j})$ N and $F_2 = (4\mathbf{i} + 2\mathbf{j})$ N. The acceleration of the particle is $4\mathbf{i}$ m/s². Find F_3 .

Solution

Newton's second law of motion gives

$$F_1 + F_2 + F_3 = 2 \times 4\mathbf{i}$$

$$2\mathbf{i} - 3\mathbf{j} + 4\mathbf{i} + 2\mathbf{j} + F_3 = 8\mathbf{i}$$

$$6\mathbf{i} - \mathbf{j} + F_3 = 8\mathbf{i}$$

$$\therefore F_3 = (2\mathbf{i} + \mathbf{j}) \text{ N}$$

Implications of Newton's third law of motion

An alternative wording of Newton's third law is:

If one object exerts a force on another (action force), then the second object exerts a force (reaction force) equal in magnitude but opposite in direction to the first.

It is important to note that the action and reaction forces, which always occur in pairs, act on different objects. If they were to act on the same object, then there would never be accelerated motion, because the resultant force on every object would be zero.

For example:

- If a person kicks a door, then the door 'accelerates' open because of the force exerted by the person. At the same time, the door exerts a force on the foot of the person which 'decelerates' the foot.
- For a particle A hanging from a string, the forces T and mg both act on the particle. They are not necessarily equal and opposite forces. In fact, they are equal only if the acceleration of the particle is zero (by Newton's second law). The forces T and mg are not an action–reaction pair of Newton's third law, as they both act on the one particle.
- If a person is pulling horizontally on a rope with a force F , then the rope exerts a force of $-F$ on the person.

**► Normal reaction force**

If a particle lies on a surface and exerts a force on the surface, then the surface exerts a force, R N, on the particle. If the surface is smooth, this force is taken to act at right angles to the surface and is called the normal reaction force.

In such a situation, we have $R = mg$.

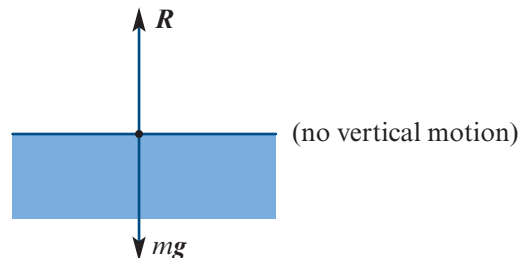

If the particle is on a platform which is being accelerated upwards at $a \text{ m/s}^2$, then $R - mg = ma$.

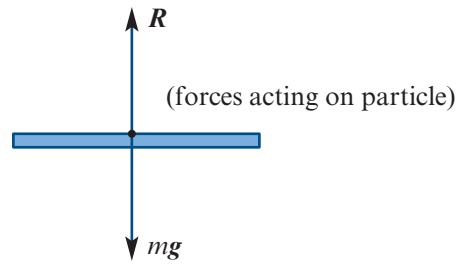

If a particle of mass $m \text{ kg}$ lies on a smooth surface and a force of $F \text{ N}$ acts at an angle of θ° to the horizontal, then $R = mg - F \sin \theta$.

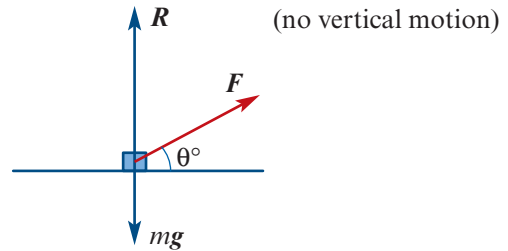

Example 11

A box is on the floor of a lift that is accelerating upwards at 2.5 m/s^2 . The mass of the box is 10 kg . Find the reaction of the floor of the lift on the box.

Solution

Let R be the reaction of the floor on the box.

Newton's second law of motion gives

$$\begin{aligned} R - 10g &= 10 \times 2.5 \\ \therefore R &= 10g + 25 \\ &= 98 + 25 \\ &= 123 \text{ N} \end{aligned}$$

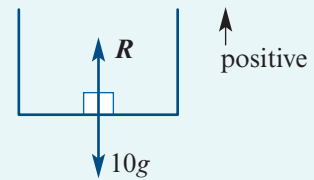

The reaction of the floor of the lift on the box is 123 N .

► Sliding friction

By experiment, it has been shown that the magnitude of the frictional force, F_R , on a particle moving on a surface is given by

$$F_R = \mu R$$

where R is the magnitude of the normal reaction force and μ is the **coefficient of friction**.

The frictional force acts in the opposite direction to the velocity of the particle.

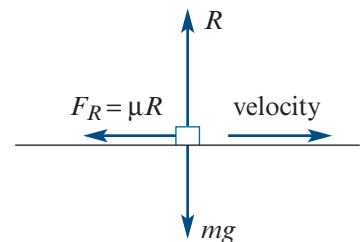

The coefficient of friction is a measure of the roughness of the surfaces of contact.

Surfaces	Coefficient of friction
Rubber tyre on dry road	approaches 1
Two wooden surfaces	0.3 to 0.5
Two metal surfaces	0.1 to 0.2

If the surface is taken to be smooth, then $\mu = 0$.

Example 12

A body of mass 5 kg at rest on a rough horizontal plane is pushed by a horizontal force of 20 N for 5 seconds.

- a** If $\mu = 0.3$, how far does the body travel in this time?
b How much further will it move after the force is removed?

Solution

- a** Resolve vertically (the j -direction):

$$(R - 5g)\mathbf{j} = \mathbf{0}$$

$$R = 5g$$

Resolve horizontally (the i -direction):

$$(20 - \mu R)\mathbf{i} = 5\mathbf{a}$$

$$(20 - 1.5g)\mathbf{i} = 5\mathbf{a}$$

$$\therefore \mathbf{a} = (4 - 0.3g)\mathbf{i}$$

$$= 1.06\mathbf{i}$$

After 5 seconds, the velocity is $1.06 \times 5 = 5.3$ m/s.

The distance travelled is given by

$$s = ut + \frac{1}{2}at^2 = \frac{1}{2} \times 1.06 \times 5^2$$

$$= 13.25 \text{ m}$$

- b** From **a**, we have $R = 5g$.

$$(-0.3 \times 5g)\mathbf{i} = 5\mathbf{a}$$

$$-0.3g = a$$

$$\therefore a = -2.94$$

Now use $v^2 = u^2 + 2as$ with $v = 0$:

$$0 = (5.3)^2 - 2 \times 2.94 \times s$$

$$s = \frac{(5.3)^2}{2 \times 2.94} \approx 4.78 \text{ m}$$

The body will come to rest after 4.78 metres.

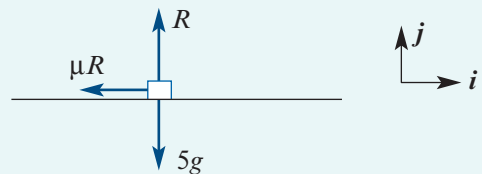
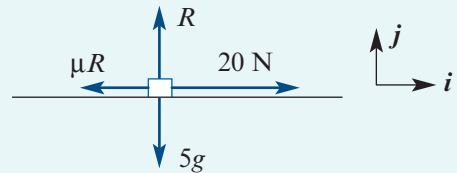

Exercise 17B

Skillsheet

1 Find the momentum of each of the following:

Example 6

- a** a mass of 2 kg moving with a velocity of 5 m/s
- b** a mass of 300 g moving with a velocity of 3 cm/s
- c** a mass of 1 tonne moving with a velocity of 30 km/h
- d** a mass of 6 kg moving with a velocity of 10 m/s
- e** a mass of 3 tonnes moving with a velocity of 50 km/h

Example 6

- 2 a** Find the momentum of a particle of mass 10 kg moving with a velocity of $(i + j)$ m/s.
- b i** Find the momentum of a particle of mass 10 kg moving with a velocity of $(5i + 12j)$ m/s.
- ii** Find the magnitude of this momentum.

Example 7

- 3** Find the change in momentum when a body of mass 10 kg moving in a straight line changes its velocity from:
- a** 6 m/s to 3 m/s **b** 6 m/s to 10 m/s **c** -6 m/s to 3 m/s

4 Find the weight, in newtons, of each of the following:

- a** a 5 kg bag of potatoes
- b** a tractor of mass 3 tonnes
- c** a tennis ball of mass 60 g

Example 8

- 5 a** A body of mass 8 kg is moving with an acceleration of 4 m/s^2 in a straight line. Find the resultant force acting on the body.
- b** A body of mass 10 kg is moving in a straight line. The resultant force acting on the body is 5 N. Find the magnitude of the acceleration of the body.
- 6 a** A force of 10 N acts on a particle of mass m kg and produces an acceleration of 2.5 m/s^2 . Find the value of m .
- b** A force of F N acts on a particle of 2 kg and produces an acceleration of 3.5 m/s^2 . Find the value of F .
- 7** What size mass would be accelerated upwards at 1.2 m/s^2 by a vertical force of 96 N?
- 8** A parachutist of mass 75 kg, whose parachute only partly opens, accelerates downwards at 1 m/s^2 . What upwards force must her parachute be providing?
- 9** In a lift that is accelerating upwards at 2 m/s^2 , a spring balance shows the apparent weight of an object to be 2.5 kg wt. What would be the reading if the lift were at rest?
- 10** An electron of mass 9×10^{-31} kg in a magnetic field has, at a given instant, an acceleration of $6 \times 10^{16} \text{ m/s}^2$. Find the resultant force on the electron at that instant.
- 11** A force of $(2i + 10j)$ N acts on a body of mass 2 kg. Find the acceleration of the body.

12 A particle of mass 10 kg is acted on by two forces $(8\mathbf{i} + 2\mathbf{j})$ N and $(2\mathbf{i} - 6\mathbf{j})$ N. Find the acceleration of the particle.

13 In a lift that is accelerating downwards at 1 m/s^2 , a spring balance shows the apparent weight of an object to be 2.5 kg wt. What would be the reading if the lift were:

a at rest

b accelerating upwards at 2 m/s^2 ?

Example 9 **14** A truck of mass 25 tonnes is travelling at 50 km/h when its brakes are applied. What constant force is required to bring it to rest in 10 seconds?

Example 10 **15** A particle of mass 16 kg is acted on by three forces \mathbf{F}_1 , \mathbf{F}_2 and \mathbf{F}_3 in newtons, where $\mathbf{F}_1 = -10\mathbf{i} - 15\mathbf{j}$ and $\mathbf{F}_2 = 16\mathbf{j}$. If the acceleration of the particle is $0.6\mathbf{i} \text{ m/s}^2$, find \mathbf{F}_3 .

Example 11 **16** A box of mass 10 kg lies on the horizontal floor of a lift which is accelerating upwards at 1.5 m/s^2 . Find the reaction, in newtons, of the lift floor on the box.

17 A particle of mass 5 kg is observed to be travelling in a straight line at a speed of 5 m/s. Three seconds later the particle's speed is 8 m/s in the same direction. Find the magnitude of the constant force which could produce this change in speed.

18 A particle of mass 4 kg is subjected to forces of $8\mathbf{i} + 12\mathbf{j}$ newtons and $6\mathbf{i} - 4\mathbf{j}$ newtons. Find the acceleration of the particle.

19 A reindeer is hauling a heavy sled of mass 300 kg across a rough surface. The reindeer exerts a horizontal force of 600 N on the sled, while the resistance to the sled's motion is 550 N. If the sled is initially at rest, find the velocity of the sled after 3 seconds.

20 A lift operator of mass 85 kg stands in a lift which is accelerating downwards at 2 m/s^2 . Find the reaction force of the lift floor on the operator.

Example 12 **21** A body of mass 10 kg on a rough horizontal table (coefficient of friction 0.2) is acted on by a horizontal force of magnitude 4 kg wt. Find:

a the acceleration of the body

b the velocity of the body after 10 seconds, if it starts from rest.

22 The engine of a train of mass 200 tonnes exerts a force of 8000 kg wt, and the total air and rail resistance is 20 kg wt per tonne. How long will it take the train on level ground to acquire a speed of 30 km/h from rest?

23 One man can push a wardrobe of mass 250 kg with an acceleration of magnitude 0.15 m/s^2 . With help from another man pushing just as hard (i.e. with the same force), the wardrobe accelerates at 0.4 m/s^2 . How hard is each man pushing and what is the resistance to sliding?

24 What force is necessary to accelerate a train of mass 200 tonnes at 0.2 m/s^2 against a resistance of 20 000 N? What will be the acceleration if the train free-wheels against the same resistance?

- 25** A body of mass 10 kg is being pulled across a rough horizontal surface by a force of magnitude 10 N. If the body is moving with constant velocity, find the coefficient of friction between the body and the surface.
- 26** A puck of mass 0.1 kg is sliding in straight line on an ice-rink. The coefficient of friction between the puck and the ice is 0.025.
- Find the resistive force owing to friction.
 - Find the speed of the puck after 20 seconds if its initial speed is 10 m/s.
- 27** A block of 4 kg will move at a constant velocity when pushed along a table by a horizontal force of 24 N. Find the coefficient of friction between the block and the table.
- 28** A load of 200 kg is being raised by a cable. Find the tension in the cable when:
- the load is lifted at a steady speed of 2 m/s
 - the load is lifted with an upwards acceleration of 0.5 m/s^2 .
- 29** Find the acceleration of a 5 kg mass for each of the following situations. (The body moves in a straight line across the surface.)

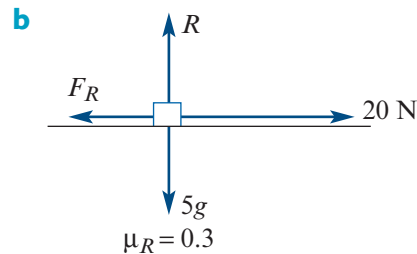
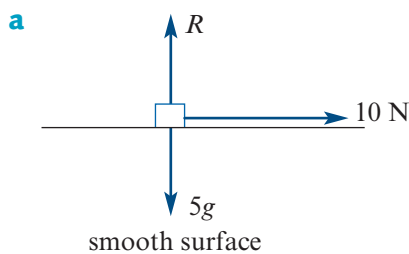

17C Resolution of forces and inclined planes

If all forces under consideration are acting in the same plane, then these forces and the resultant force can each be expressed as a sum of its i - and j -components.

If a force F acts at an angle of θ to the x -axis, then F can be written as the sum of two forces, one 'horizontal' and the other 'vertical':

$$F = |F| \cos \theta \mathbf{i} + |F| \sin \theta \mathbf{j}$$

The force F is **resolved** into two components:

- the i -component is parallel to the x -axis
- the j -component is parallel to the y -axis.

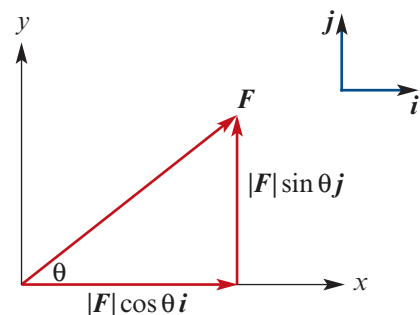

Example 13

A particle at O is acted on by forces of magnitude 3 N and 5 N as in Example 1. If the particle has mass 1 kg, find the acceleration and state the direction of the acceleration.

Solution

The resultant force $F = 6.33i + 3.89j$ was found in Example 1.

Using the equation $F = ma$ gives

$$a = 6.33i + 3.89j$$

The direction of the acceleration is the same as the direction of the force, i.e. at 31.59° anticlockwise from the x -axis.

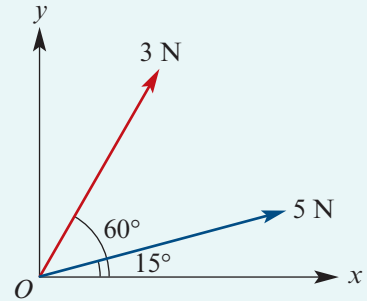
**Example 14**

A block of mass 10 kg is pulled along a horizontal plane by a force of 10 N inclined at 30° to the plane. The coefficient of friction between the block and the plane is 0.05. Find the acceleration of the block.

Solution

Resolving in the j -direction:

$$(R + 10 \cos 60^\circ - 10g)j = \mathbf{0}$$

$$\begin{aligned} \therefore R &= 10(g - \cos 60^\circ) \\ &= 10(g - \frac{1}{2}) \end{aligned}$$

Resolving in the i -direction:

$$(10 \cos 30^\circ - \mu R)i = 10a$$

$$\cos 30^\circ - 0.05(g - \frac{1}{2}) = a$$

$$\therefore a \approx 0.4 \text{ m/s}^2$$

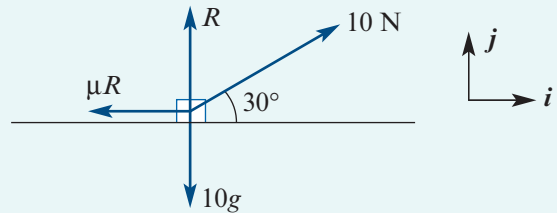

The acceleration of the block is approximately 0.4 m/s^2 .

► Normal reaction forces for inclined planes

For a mass on a plane that is inclined to the horizontal, the normal reaction force is at right angles to the plane.

In such a situation, it is often advantageous to choose the direction up the plane to be i and the direction perpendicular from the plane to be j .

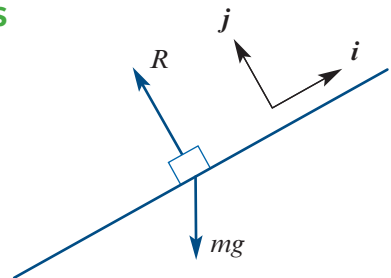

Example 15

A particle of mass 5 kg lies on a smooth plane inclined at 30° to the horizontal. There is a force of 15 N acting up the plane. Find the acceleration of the particle down the incline and the reaction force R .

Solution

Resolving in the i -direction:

$$15 + 5g \cos 120^\circ = 15 - \frac{49}{2} = \frac{-19}{2}$$

For the i -direction:

$$\frac{-19}{2}i = 5a$$

$$\therefore a = -1.9i$$

The acceleration is 1.9 m/s^2 down the plane.

Resolving in the j -direction:

$$R + 5g \cos 150^\circ = R - \frac{5\sqrt{3}}{2}g = 0$$

$$\therefore R = \frac{5\sqrt{3}}{2}g$$

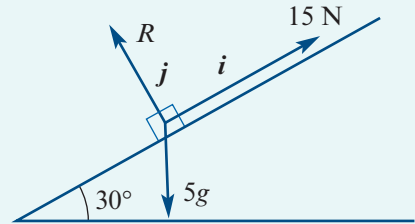
**Example 16**

A slope is inclined at an angle θ to the horizontal, where $\tan \theta = \frac{4}{3}$. A particle is projected from the foot of the slope up a line of greatest slope with a speed of $V \text{ m/s}$ and comes instantaneously to rest after travelling 6 m. If the coefficient of friction is $\frac{1}{2}$, calculate:

- a** the value of V **b** the speed of the particle when it returns to its starting point.

Solution

a Note: Friction acts in the opposite direction to motion.

Resolving in the j -direction:

$$mg \cos \theta = R$$

Since $\tan \theta = \frac{4}{3}$, we have $\cos \theta = \frac{3}{5}$ and so

$$\frac{3mg}{5} = R$$

Resolving parallel to the plane (the i -direction):

$$-\mu R - mg \sin \theta = ma \quad (\text{Newton's second law})$$

Since $\tan \theta = \frac{4}{3}$, we have $\sin \theta = \frac{4}{5}$ and so

$$\begin{aligned} -\frac{1}{2} \times \frac{3mg}{5} - \frac{4mg}{5} &= ma \\ \frac{-11g}{10} &= a \end{aligned}$$

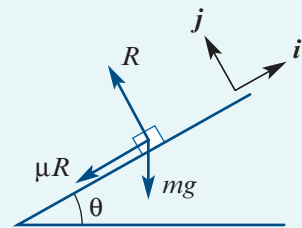

The acceleration is $\frac{-11g}{10}$ m/s².

Now we use the equation of motion $v^2 = V^2 + 2as$.

The particle comes to rest when $s = 6$ and $v = 0$, so

$$0 = V^2 - \frac{66g}{5}$$

$$V^2 = \frac{66g}{5}$$

$$\therefore V = \sqrt{\frac{66g}{5}} \approx 11.37$$

(Note that V is positive, as the particle is projected up the plane.)

The initial velocity is 11.37 m/s.

b Friction now acts up the plane.

Resolving in the i -direction:

$$\mu R - mg \sin \theta = ma$$

$$\frac{1}{2} \times \frac{3mg}{5} - \frac{4mg}{5} = ma$$

$$\text{i.e. } a = -\frac{g}{2}$$

Using $v^2 = u^2 + 2as$ again:

$$\begin{aligned} v^2 &= 2 \times \left(-\frac{g}{2}\right) \times (-6) \\ &= 6g \end{aligned}$$

$$\therefore v = 7.67 \text{ m/s}$$

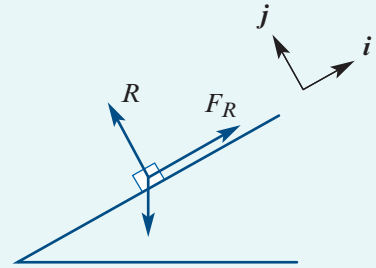

Exercise 17C

Skillsheet

- 1** A particle has mass 1 kg. It is acted on by two forces of magnitudes 3N and 5N, which act on the particle at an angle of 50° to each other. Find the magnitude of the resulting acceleration and state its direction relative to the 5N force.

Example 13

- 2** Find the acceleration of a 5 kg mass for each of the following situations:

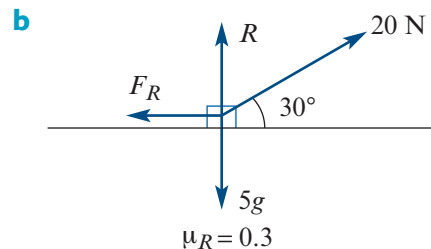
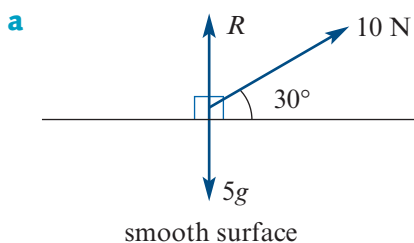

- 3** A particle slides down a smooth slope of 45° . What is its acceleration?
- 4** A particle of mass m kg slides down a slope of 45° . If the coefficient of friction of the surfaces involved is μ , find the acceleration.

Example 15

- 5** A particle of mass 10 kg lies on a plane inclined at 30° to the horizontal. There is a force of 10 N, acting up the plane, that resists motion. Find the acceleration of the particle down the incline and the reaction force R .
- 6** A 60 kg woman skis down a slope that makes an angle of 60° with the horizontal. The woman has an acceleration of 8 m/s^2 . What is the magnitude of the resistive force?
- 7** A block of mass 2 kg lies on a rough horizontal table, with a coefficient of friction of $\frac{1}{2}$. Find the magnitude of the force on the block which, when acting at 45° upwards from the horizontal, produces in the block a horizontal acceleration of $\frac{g}{4} \text{ m/s}^2$.
- 8** A box of mass 20 kg is pulled along a smooth horizontal table by a force of 30 newtons acting at an angle of 30° to the horizontal. Find the magnitude of the normal reaction of the table on the box.

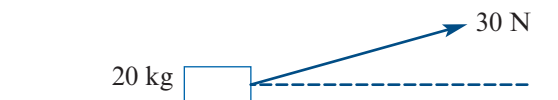

- 9** A particle of mass m kg is being accelerated up a rough inclined plane, with coefficient of friction μ , at $a \text{ m/s}^2$ by a force of P N acting parallel to the plane. The plane is inclined at an angle of θ° to the horizontal. Find a in terms of P , θ , m , μ and g .

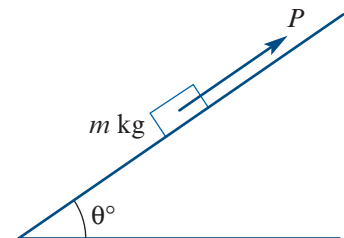

- 10** A particle is projected up a smooth plane inclined at 30° to the horizontal. Let i be the unit vector up the plane. Find the acceleration of the particle.
- 11** A particle slides from rest down a rough plane inclined at 60° to the horizontal. Given that the coefficient of friction between the particle and the plane is 0.8, find the speed of the particle after it has travelled 5 m.

Example 16

- 12** A body is projected up an incline of 20° with a velocity of 10 m/s. If the coefficient of friction between the body and the plane is 0.25, find the distance it goes up the plane and the velocity with which it returns to its starting point.

- 13** A particle of mass m kg slides down a smooth inclined plane x metres long, inclined at θ° to the horizontal, where $\tan \theta = \frac{4}{3}$.
- With what speed does the particle reach the bottom of the plane?
 - At the bottom, it slides over a rough horizontal surface (coefficient of friction 0.3). How far will it travel along this surface?
- 14** A body of mass of M kg is pulled along a rough horizontal plane (coefficient of friction μ) by a constant force of F newtons, at an inclination of θ . Find the acceleration of the body if:
- θ is upwards from the horizontal
 - θ is downwards from the horizontal.
- 15** A car of mass 1 tonne coasts at a constant speed down a slope inclined at θ° to the horizontal, where $\sin \theta = \frac{1}{20}$. The car can ascend the same slope with a maximum acceleration of 1 m/s^2 . Find:
- the total resistance to the motion (assumed constant)
 - the driving force exerted by the engine when the maximum acceleration is reached.
- 16** A particle of mass 0.5 kg is projected up the line of greatest slope of a rough plane inclined at an angle θ to the horizontal, where $\sin \theta = \frac{3}{5}$. Given that the speed of projection is 6 m/s and that the coefficient of friction between the particle and the plane is $\frac{3}{8}$, calculate:
- the distance travelled up the plane when the speed has fallen to 4 m/s
 - the speed of the particle when it returns to its point of projection.
- 17** A body of mass 5 kg is placed on a smooth horizontal plane and is acted upon by the following horizontal forces:
- a force of 8 N in a direction of 330°
 - a force of 10 N in a direction of 090°
 - a force of P N in a direction of 180°
- Given that the magnitude of the acceleration of the body is 2 m/s^2 , calculate the value of P correct to two decimal places.
- 18** A particle of mass 5 kg is being pulled up a slope inclined at 30° to the horizontal. The pulling force, F newtons, acts parallel to the slope, as does the resistance with a magnitude one-fifth of the magnitude of the normal reaction.
- Find the value of F such that the acceleration is 1.5 m/s^2 up the slope.
 - Also find the magnitude of the acceleration if this pulling force now acts at an angle of 30° to the slope (i.e. at 60° to the horizontal).



17D Connected particles

Consider a light rope being pulled from each end. The light rope is considered to have zero mass. Applying Newton's laws of motion, we have $T = S$. At every point on this rope, two forces are acting which are equal and opposite and have magnitude T .

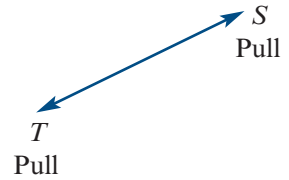

The following are examples of connected particles. Diagrams are given and the forces shown.

- Two particles connected by a taut rope moving on a smooth plane.

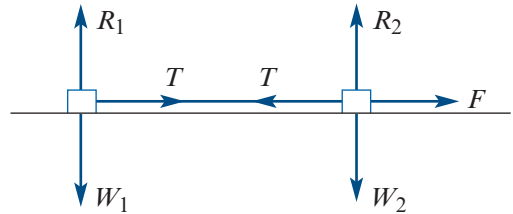

- A smooth light pulley (i.e. the weight of the pulley is considered negligible and the friction between rope and pulley is negligible). The tensions in both sections of the rope can be assumed to be equal.

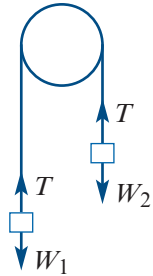

- The tension in the string is of equal magnitude in both sections. The inclined plane is rough. The body on the inclined plane is accelerating *up* the plane.

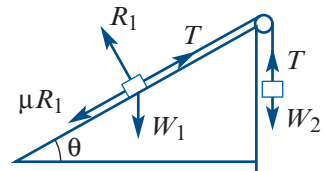

- The body is accelerating *down* the inclined plane.

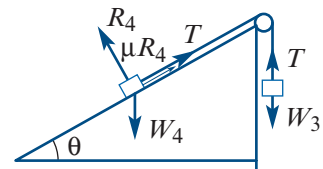

- Two masses on a smooth inclined plane. In general, $T_1 \neq T_2$.

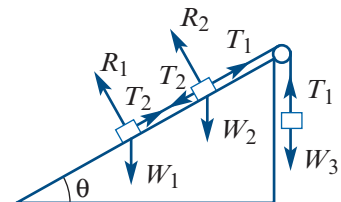

Example 17

A car of mass 1 tonne tows another car of mass 0.75 tonnes with a light tow rope. If the towing car exerts a tractive force of magnitude 3000 newtons and the resistance to motion can be neglected, find the acceleration of the two cars and the tension in the rope.

Solution

Note that $S = T$ and the forces act in opposite directions.

Apply Newton's second law to both cars:

$$3000 = (750 + 1000)a$$

$$\therefore a = \frac{3000}{1750} = \frac{12}{7} = 1\frac{5}{7} \text{ m/s}^2$$

Apply Newton's second law to the second car:

$$S = 750 \times \frac{12}{7} \approx 1285.71$$

The tension in the rope is 1286 newtons, to the nearest unit.

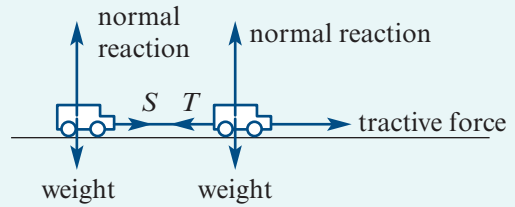
**Example 18**

The diagram shows three masses of 4 kg, 5 kg and 11 kg connected by light inextensible strings, one of which passes over a smooth fixed pulley. The system is released from rest.

Calculate:

- the acceleration of the masses
- the tension in the string joining the 4 kg mass to the 11 kg mass
- the tension in the string joining the 4 kg mass to the 5 kg mass.

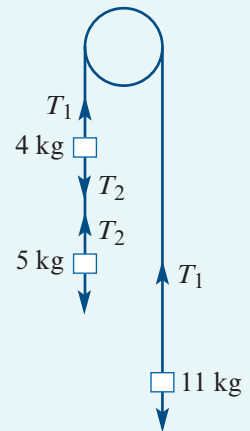
**Solution**

- a** Use Newton's second law.

$$\text{For the 11 kg mass: } 11g - T_1 = 11a \quad (1)$$

$$\text{For the 5 kg mass: } T_2 - 5g = 5a \quad (2)$$

$$\text{For the 4 kg mass: } T_1 - T_2 - 4g = 4a \quad (3)$$

$$\text{Add (1) and (3): } 7g - T_2 = 15a \quad (4)$$

$$\text{Add (2) and (4): } 2g = 20a$$

$$\therefore a = 0.1g$$

The acceleration of the system is $0.1g \text{ m/s}^2$.

b From (1): $11g - T_1 = 1.1g$

$$\therefore T_1 = 9.9g$$

The tension in the rope between the 11 kg and 4 kg masses is 9.9g newtons.

c From (4): $7g - T_2 = 1.5g$

$$\therefore T_2 = 5.5g$$

The tension in the rope between the 4 kg and 5 kg masses is 5.5g newtons.

Exercise 17D

Skillsheet

- 1** Two masses of 8 kg and 10 kg are suspended by a light inextensible string over a smooth pulley.

- a** Find the tension in the string.
b Find the acceleration of the system.

Example 17

- 2** Two particles of mass 6 kg and 5 kg are pulled along a smooth horizontal plane. The forces are as shown. If the magnitude of F is 10 N, find:

- a** the acceleration of the system
b T and S .

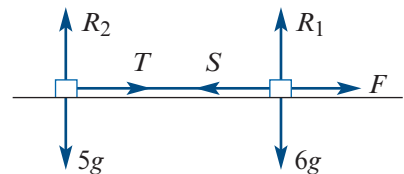

- 3** A mass of 1.5 kg is connected to a mass of 2 kg by a light inelastic string which passes over a smooth pulley as shown. Find:

- a** the tension in the string
b the acceleration of the system.

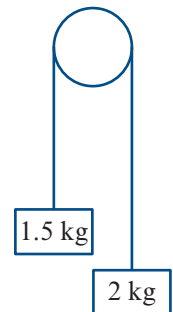

- 4** The diagram shows a smooth plane inclined at an angle of 25° to the horizontal. At the top of the plane, there is a smooth pulley over which passes a taut light string. On the end of the string is attached a block of mass 5 kg lying on the plane. The other end is attached to a block of mass M kg hanging vertically. If the mass of M kg is moving downwards with an acceleration of 1 m/s^2 , find:

- a** M
b the tension in the string.

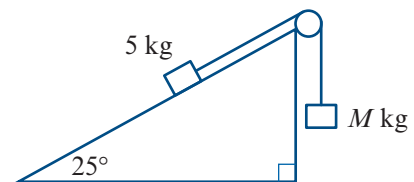

- 5 The diagram shows a particle of mass 4 kg on a smooth horizontal table. The particle is connected by a light inelastic string which passes over a smooth pulley to a particle of mass 8 kg which hangs vertically. Find:

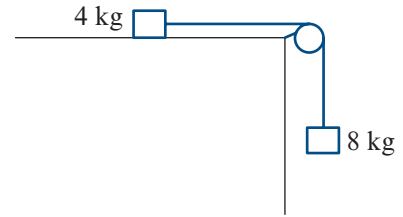

- a the acceleration of the system
b the tension in the string.
- 6 A mass of 2 kg, resting on a smooth plane inclined at 30° to the horizontal, is connected to a mass of 4 kg by a light inelastic string which passes over a smooth pulley, as shown in the diagram. Find:

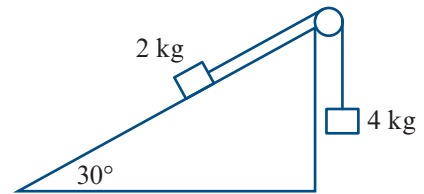

- a the tension in the string
b the acceleration of the system.
- 7 Two masses of 10 kg and 5 kg are placed on smooth inclines of 30° and 45° , placed back to back. The masses are connected by a light string over a smooth pulley at the top of the plane.

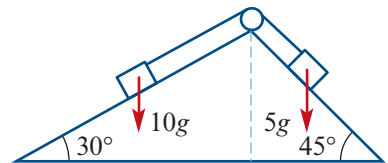

- a Find the acceleration of the system.
b Find the tension in the string.
- 8 In the situation shown in the diagram, what mass m kg is required in order to give the system an acceleration of 0.8 m/s^2 ?

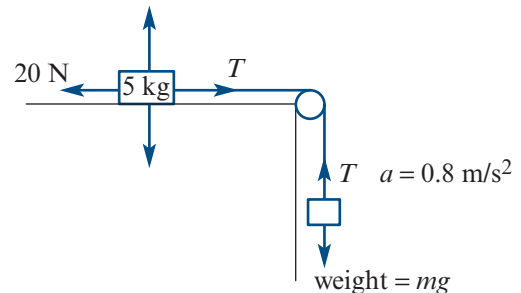

- 9 A truck of mass 10 tonnes pulls a trailer of mass 5 tonnes with an acceleration of magnitude 2 m/s^2 . The truck exerts a tractive force of magnitude 40 000 N. The trailer has resistance to motion of 750 N.

- a What is the tension in the coupling?
b What is the resistance to motion of the truck?
- 10 Two particles of masses 3 kg and x kg ($x > 3$) are connected by a light inextensible string passing over a smooth fixed pulley. The system is released from rest while the hanging portion of the string is taut and vertical. Given that the tension in the string is 37.5 N, calculate the value of x .

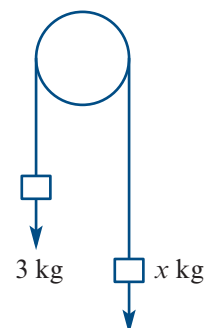

- 11** An engine of mass 40 tonnes is pulling a truck of mass 8000 kg up a plane inclined at θ° to the horizontal, where $\sin \theta = \frac{1}{8}$. If the tractive force exerted by the engine is 60 000 N, calculate:
- the acceleration of the engine
 - the tension in the coupling between the engine and the truck.

- Example 18** **12** The diagram shows masses of 8 kg and 12 kg lying on a smooth horizontal table and joined, by a light inextensible string, to a mass of 5 kg hanging freely. This string passes over a smooth pulley at the edge of the table. The system is released from rest. Find:

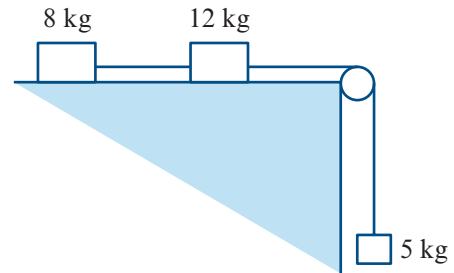

- the tension in the string connecting the 8 kg and 12 kg masses
 - the tension in the string connecting the 12 kg and 5 kg masses
 - the acceleration of the system.
- 13** A hanging mass of 200 g drags a mass of 500 g along a rough table 3 metres from rest in 3 seconds. What is the coefficient of friction?

- 14** Two blocks *A* and *B*, of masses 4 kg and 6 kg respectively, are connected by a light string passing over a smooth pulley. Block *A* rests on a rough plane inclined at 30° to the horizontal. When the blocks are released from rest, block *B* moves downwards with an acceleration of 1 m/s^2 .

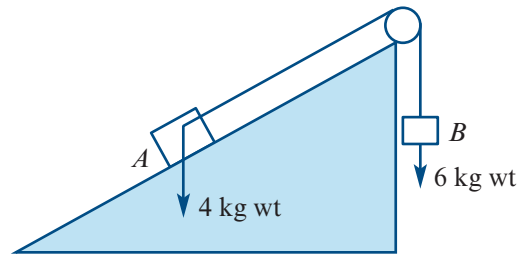

- Calculate the value of μ , the coefficient of friction between *A* and the inclined plane.
 - Find the tension in the string connecting *A* and *B*.
- 15** A particle of mass 3 kg rests on a rough horizontal surface. The particle is attached by a light inextensible string, passing over a smooth fixed pulley, to a particle of mass 4.2 kg on a smooth plane inclined at an angle of θ° to the horizontal, where $\sin \theta = 0.6$. When the system is released from rest, each particle moves with an acceleration of 2 m/s^2 .

Calculate:

- the tension in the string
- the coefficient of friction between the horizontal surface and the particle of mass 3 kg.

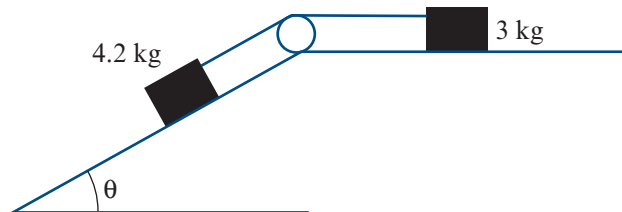

17E Variable forces

In the previous sections of this chapter, we have considered constant forces. In this section, we consider variable forces. We will use the expressions for acceleration from Chapter 14:

$$a = \frac{d^2x}{dt^2} = \frac{dv}{dt} = v \frac{dv}{dx} = \frac{d}{dx} \left(\frac{1}{2}v^2 \right)$$

where x , v and a are the position, velocity and acceleration at time t respectively.

Note: It was observed in Chapter 14 that the last form is not really necessary, as the form

$$a = v \frac{dv}{dx} \text{ can be used instead, together with separation of variables.}$$



Example 19

A body of mass 5 kg, initially at rest, is acted on by a force of $F = (6 - t)^2$ newtons, where $0 \leq t \leq 6$ (seconds). Find the speed of the body after 6 seconds and the distance travelled.

Solution

Newton's second law of motion gives

$$F = ma$$

$$(6 - t)^2 = 5a$$

$$a = \frac{1}{5}(6 - t)^2$$

Hence $\frac{dv}{dt} = \frac{1}{5}(6 - t)^2$

giving $v = \frac{1}{5} \int (6 - t)^2 dt$

$$= \frac{1}{5} \times (-1) \times \frac{(6 - t)^3}{3} + c$$

$$= -\frac{1}{15}(6 - t)^3 + c$$

When $t = 0$, $v = 0$, so $c = \frac{72}{5}$.

$$\therefore v = -\frac{1}{15}(6 - t)^3 + \frac{72}{5}$$

When $t = 6$, $v = \frac{72}{5}$, i.e. the velocity after 6 seconds is $\frac{72}{5}$ m/s.

Integrating again with respect to t gives

$$x = \frac{1}{60}(6 - t)^4 + \frac{72}{5}t + d$$

When $t = 0$, $x = 0$ and therefore $d = -21.6$.

Hence when $t = 6$, $x = \frac{72}{5} \times 6 - 21.6 = 64.8$.

The distance travelled is 64.8 m.



Example 20

A particle of mass 3 units moves in a straight line and, at time t , its position relative to a fixed origin is x and its speed is v .

- a** If the resultant force is $9 \cos t$, and $v = 2$ and $x = 0$ when $t = 0$, find x in terms of t .
b If the resultant force is $3 + 6x$, and $v = 2$ when $x = 0$, find v when $x = 2$.

Solution

- a** Using Newton's second law of motion: **b** Using Newton's second law of motion:

$$F = ma$$

$$9 \cos t = 3a$$

$$a = 3 \cos t$$

$$\frac{dv}{dt} = 3 \cos t$$

$$\therefore v = 3 \sin t + c$$

When $t = 0$, $v = 2$, so $c = 2$.

Hence $v = 3 \sin t + 2$

i.e. $\frac{dx}{dt} = 3 \sin t + 2$

$$\therefore x = -3 \cos t + 2t + d$$

When $t = 0$, $x = 0$ and therefore $d = 3$.

Hence $x = 3 - 3 \cos t + 2t$.

$$F = ma$$

$$3 + 6x = 3a$$

$$1 + 2x = a$$

$$v \frac{dv}{dx} = 1 + 2x$$

$$\therefore \frac{1}{2}v^2 = x + x^2 + c$$

When $x = 0$, $v = 2$. Therefore $c = 2$.

Thus $\frac{1}{2}v^2 = x + x^2 + 2$

When $x = 2$:

$$\frac{1}{2}v^2 = 2 + 4 + 2$$

$$\therefore v = \pm 4$$

Exercise 17E

Skillsheet

Example 19

- 1** A body of mass 10 kg, initially at rest, is acted on by a force of $F = (10 - t)^2$ newtons at time t seconds, where $0 \leq t \leq 10$. Find the speed of the body after 10 seconds and the distance travelled.

Example 20

- 2** A particle of mass 5 kg moves in a straight line and, at time t seconds, its position relative to a fixed origin is x m and its speed is v m/s.
- a** If the resultant force acting is $10 \sin t$, and $v = 4$ and $x = 0$ when $t = 0$, find x in terms of t .
b If the resultant force acting is $10 + 5x$, and $v = 4$ when $x = 0$, find v when $x = 4$.
c If the resultant force acting is $10 \cos^2 t$, and $v = 0$ and $x = 0$ when $t = 0$, find x in terms of t .
- 3** A body of mass 6 kg, moving initially with a speed of 10 m/s, is acted on by a force $F = \frac{100}{(t+5)^2}$ N. Find the speed reached after 10 seconds and the distance travelled in this time.

- 4 A particle of unit mass is acted on by a force of magnitude $1 - \sin\left(\frac{t}{4}\right)$, for $0 \leq t \leq 2\pi$. If the particle is initially at rest, find an expression for the distance covered at time t .
- 5 A particle of unit mass is acted on by a force of magnitude $1 - \cos\left(\frac{1}{2}t\right)$, for $0 \leq t \leq \frac{\pi}{2}$. If the particle is initially at rest, find an expression for:
- a** the velocity at time t **b** the displacement at time t .
- 6 A particle of mass 4 kg is acted on by a resultant force whose direction is constant and whose magnitude at time t seconds is $(12t - 3t^2)$ N. If the particle has an initial velocity of 2 m/s in the direction of the force, find the velocity at the end of 4 seconds.
- 7 A particle of mass 1 kg on a smooth horizontal plane is acted on by a horizontal force $\frac{t}{t+1}$ N at time t seconds after it starts from rest. Find its velocity after 10 seconds.
- 8 A body of mass 0.5 kg is acted on by a resultant force $e^{-\frac{t}{2}}$ N at time t seconds after the body is at rest.
- a** If the body starts from rest, find the velocity, v m/s, at time t seconds.
b Sketch the velocity–time graph.
c If the body moves under the given force for 30 seconds, find the distance travelled.
- 9 A body of mass 10 units is accelerated from rest by a force F whose magnitude at time t is given by
- $$F(t) = \begin{cases} 14 - 2t & \text{for } 0 \leq t \leq 5 \\ 100t^{-2} & \text{for } t > 5 \end{cases}$$
- Find:
- a** the speed of the body when $t = 10$
b the distance travelled by this time.
- 10 A body of mass m kg moving with a velocity of u m/s ($u > 0$) is acted on by a resultant force kv N (in its initial direction), where v m/s is its velocity at time t seconds and k is a positive constant. Find the distance travelled after t seconds.
- 11 A particle of mass m is projected along a horizontal line from O with speed V . It is acted on by a resistance kv when the speed is v . Find the velocity after the particle has travelled a distance x .
- 12 A particle of mass m kg at rest on a horizontal plane is acted on by a constant horizontal force b N. The total resistance to motion is cv N, where v m/s is the velocity and c is a constant value. Find the velocity at time t seconds and the terminal velocity.
- 13 A body of mass m is projected vertically upwards with speed u . Air resistance is equal to k times the square of the speed, where k is a constant. Find the maximum height reached and the speed when next at the point of projection.

14 A particle of mass 0.2 kg moving on the positive x -axis has position x metres and velocity v m/s at time t seconds. At time $t = 0$, $v = 0$ and $x = 1$. The particle moves under the action of a force of magnitude $\frac{4}{x}$ N in the positive direction of the x -axis. Show that $v = \sqrt{40 \ln x}$.

15 A particle P of unit mass moves on the positive x -axis. At time t , the velocity of the particle is v and the force F acting on the particle is given by

$$F = \begin{cases} \frac{50}{25 + v} & \text{for } 0 \leq t \leq 50 \\ \frac{-v^2}{1000} & \text{for } t > 50 \end{cases}$$

Initially the particle is at rest at the origin O .

- a** Show that $v = 50$ when $t = 50$.
b Find the distance of P from O when $v = 50$.
c Find the distance of P from O when $v = 25$ and $t > 50$.



17F Equilibrium

If the resultant force acting on a particle is zero, the particle is said to be in **equilibrium**.

The particle has zero acceleration:

- If the particle is at rest, it will remain at rest.
- If the particle is moving, it will continue to move with constant velocity.

► Triangle of forces

If three forces are acting on a particle in equilibrium, then they can be represented by three vectors forming a triangle.

Suppose that three forces F_1 , F_2 and F_3 are acting on a particle in equilibrium, as shown in the diagram on the left. Since the particle is in equilibrium, we must have $F_1 + F_2 + F_3 = \mathbf{0}$. Therefore the three forces can be rearranged into a triangle as shown below.

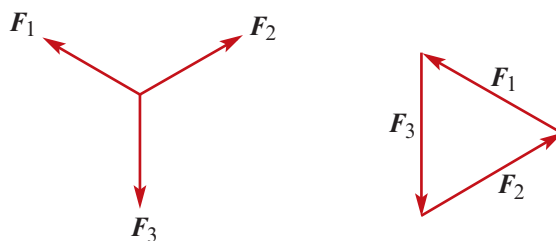

The magnitudes of the forces and the angles between the forces can now be found using trigonometric ratios (if the triangle contains a right angle) or using the sine or cosine rule.

This can, of course, be generalised to any number of vectors by using a suitable polygon.

Example 21

Forces of magnitude 2 N, 4 N and 5 N act on a particle in equilibrium.

- a** Sketch a triangle of forces to represent the three forces.
b Find the angle between the 2 N and 4 N forces, correct to two decimal places.

Solution

- a** Let θ° be the angle between the 2 N and 4 N forces.

In the triangle of forces, the angle between the 2 N and 4 N forces is $(180 - \theta)^\circ$.

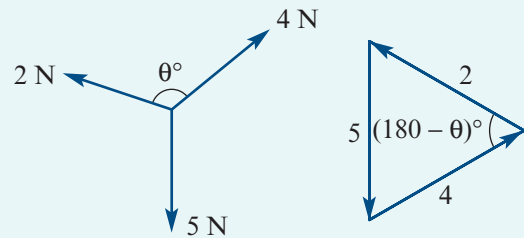

- b** By the cosine rule:

$$25 = 4 + 16 - 2 \times 2 \times 4 \cos(180 - \theta)^\circ$$

$$\cos(180 - \theta)^\circ = -\frac{5}{16}$$

$$(180 - \theta)^\circ = 108.21^\circ \quad (\text{to two decimal places})$$

$$\therefore \theta = 71.79^\circ$$

The angle between the 2 N and 4 N forces is 71.79° , correct to two decimal places.

Example 22

Forces of magnitude 3 N, 4 N and P N act on a particle which is in equilibrium, as shown in the diagram.

Find the magnitude of P .

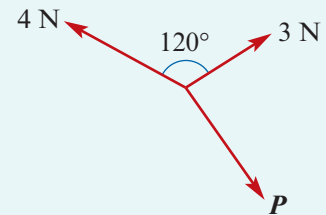
**Solution**

Complete the triangle of forces as shown.

The cosine rule gives

$$|P|^2 = 4^2 + 3^2 - 2 \times 4 \times 3 \cos 60^\circ$$

$$|P|^2 = 16 + 9 - 24 \times \frac{1}{2}$$

$$= 16 + 9 - 12$$

$$= 13$$

$$\therefore |P| = \sqrt{13} \text{ N}$$

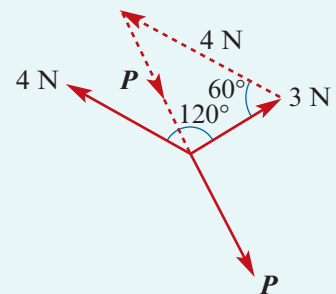

► Lami's theorem

Lami's theorem is a trigonometric identity which simplifies problems involving three forces acting on a particle in equilibrium when the angles between the forces are known.

Lami's theorem

Let P N, Q N and R N be forces acting on a particle, forming angles with each other as shown.

If the particle is in equilibrium, then

$$\frac{P}{\sin p^\circ} = \frac{Q}{\sin q^\circ} = \frac{R}{\sin r^\circ}$$

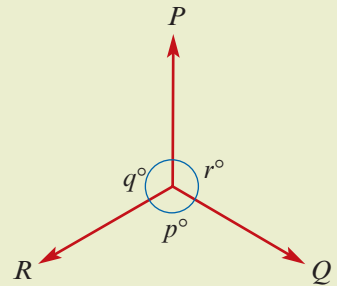

Proof Complete the triangle of forces as shown.

The sine rule now gives

$$\frac{P}{\sin(180 - p)^\circ} = \frac{Q}{\sin(180 - q)^\circ} = \frac{R}{\sin(180 - r)^\circ}$$

i.e.
$$\frac{P}{\sin p^\circ} = \frac{Q}{\sin q^\circ} = \frac{R}{\sin r^\circ}$$

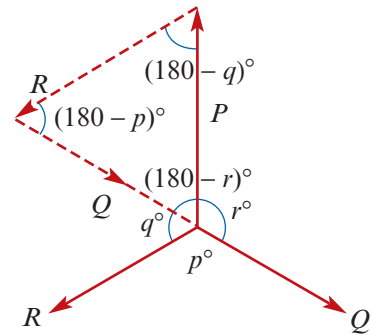

Example 23

Find P and Q in the system of forces in equilibrium as shown in the diagram.

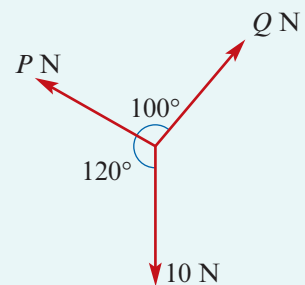

Solution

Applying Lami's theorem, we have

$$\frac{10}{\sin 100^\circ} = \frac{Q}{\sin 120^\circ} = \frac{P}{\sin 140^\circ}$$

Therefore

$$Q = \frac{10 \sin 120^\circ}{\sin 100^\circ} = 8.79 \quad (\text{correct to two decimal places})$$

and
$$P = \frac{10 \sin 140^\circ}{\sin 100^\circ} = 6.53 \quad (\text{correct to two decimal places})$$

► Resolution of forces

For three forces $F_1 = a_1\mathbf{i} + b_1\mathbf{j}$, $F_2 = a_2\mathbf{i} + b_2\mathbf{j}$ and $F_3 = a_3\mathbf{i} + b_3\mathbf{j}$, we have

$$\mathbf{F}_1 + \mathbf{F}_2 + \mathbf{F}_3 = \mathbf{0} \quad \text{if and only if} \quad a_1 + a_2 + a_3 = 0 \text{ and } b_1 + b_2 + b_3 = 0$$

For coplanar forces, we can show that the resultant force is zero by showing that the sum of the resolved parts in each of two perpendicular directions is zero.

Example 24

Three forces of 10 N act on a particle as shown in the diagram.

Show that the particle is in equilibrium by resolving in the i - and j -directions.

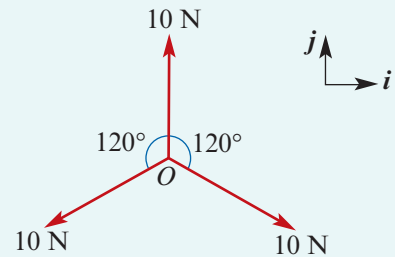

Solution

Sum of the resolved parts of the forces in the j -direction:

$$10 + 10 \cos 120^\circ + 10 \cos 120^\circ = 10 - 5 - 5 = 0$$

Sum of the resolved parts of the forces in the i -direction:

$$10 \cos 90^\circ + 10 \cos 30^\circ + 10 \cos 150^\circ = 0 + 10 \times \frac{\sqrt{3}}{2} + 10 \times \left(-\frac{\sqrt{3}}{2}\right) = 0$$

Therefore the particle is in equilibrium.

Example 25

The angles between three forces of magnitudes 10 N, P N and Q N acting on a particle are 100° and 120° respectively. Find P and Q , given that the system is in equilibrium.

Solution

We choose to resolve in directions along and perpendicular to the line of action of the P N force.

In the j -direction, the sum of the resolved parts (in newtons) is

$$10 \cos 100^\circ + P + Q \cos 120^\circ = 0 \quad (1)$$

In the i -direction, the sum of the resolved parts (in newtons) is

$$10 \cos 10^\circ + Q \cos 150^\circ = 0 \quad (2)$$

From (2): $Q = \frac{-10 \cos 10^\circ}{\cos 150^\circ} = 11.37$ (to two decimal places)

From (1): $P = -10 \cos 100^\circ - Q \cos 120^\circ = 7.42$ (to two decimal places)

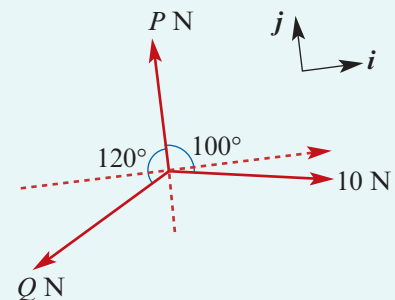

Exercise 17F

Complete Questions 1–4 using triangles of forces.

- Example 21** 1 For each of the following situations where a particle is in equilibrium, sketch the corresponding triangle of forces:

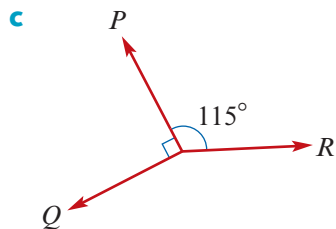
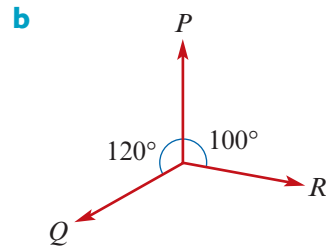
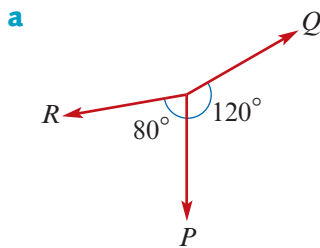

- Example 22** 2 Forces of 2 N and 5 N act on a particle, as shown in the diagram. A force of P N acts such that the particle is in equilibrium.

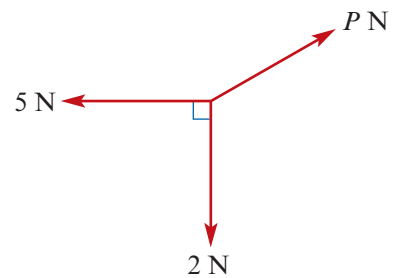

- Sketch a triangle of forces to represent the forces 2 N, 5 N and P N.
- Find P .
- Find the angle that the force of P N makes with the force of 5 N.

- 3 Forces of 7 N, 5 N and P N act on a particle in equilibrium, as shown in the diagram.

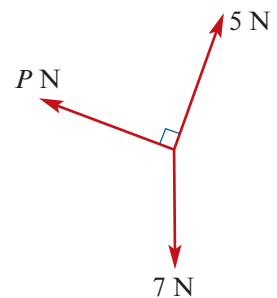

- Sketch a triangle of forces to represent the forces 7 N, 5 N and P N.
- Find P .
- Find the angle between the forces of 5 N and 7 N.

- 4 Forces of 10 N, P N and Q N act on a particle in equilibrium, as shown in the diagram.

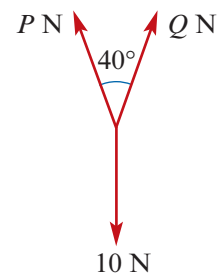

- Sketch a triangle of forces to represent the forces 10 N, P N and Q N.
- If $P = Q$, find P .

Complete Questions 5–7 using Lami's theorem.

Example 23 5 Find P and Q in each of the following systems of forces in equilibrium:

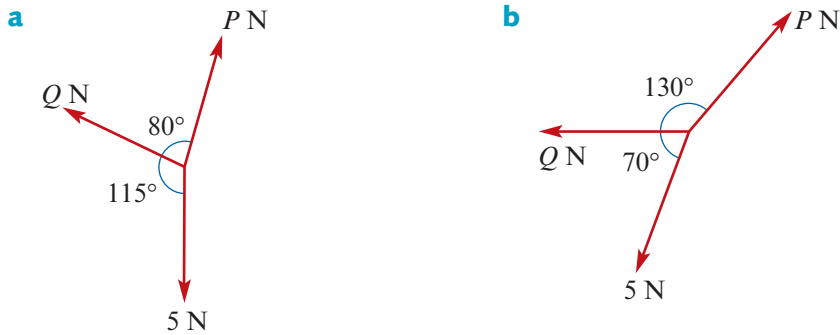

- 6 Two forces of 10 N and a third force of P N act on a body in equilibrium. The angle between the lines of action of the 10 N forces is 50° . Find P .
- 7 A particle of mass 5 kg hangs from a fixed point O by a light inextensible string. It is pulled aside by a force of P N that makes an angle of 100° with the downwards vertical, and rests in equilibrium with the string inclined at 60° to the vertical. Find P .

Complete Questions 8–11 using resolution of forces.

Example 24 8 The angles between the forces of magnitudes 10 N, 5 N and $5\sqrt{3}$ N acting on a particle are 120° and 90° respectively. Show that the particle is in equilibrium.

- 9 Two equal forces of 10 N act on a particle. The angle between the two forces is 50° .
- State the direction of the resultant of the two forces with respect to the forces.
 - Find the magnitude of the resultant of the two forces.
 - Find the magnitude and direction of the single force which, when applied, will hold the particle in equilibrium.

Example 25 10 The angles between three forces P N, Q N and 23 N acting on a particle in equilibrium are 80° and 145° respectively. Find P and Q .

- 11 The angles between four forces 10 N, 15 N, P N and Q N acting on a particle in equilibrium are 90° , 120° and 90° respectively. Find P and Q .
- 12 Forces of 8 N, 16 N and 10 N act on a particle in equilibrium.
- Sketch a triangle of forces to represent the three forces.
 - Find the angle between the 8 N and 16 N forces.

- 13** The angles between the three forces 3 N, 5 N and P N acting on a body in equilibrium are 100° and θ° respectively.
- Sketch a triangle of forces to represent the three forces.
 - Find P by using the cosine rule.
 - Hence find θ .
- 14** A particle of mass 2 kg hangs from a fixed point, O , by a light inextensible string of length 2.5 m. It is pulled aside a horizontal distance of 2 m by a force P N inclined at an angle of 75° with the downwards vertical, and rests in equilibrium. Find P and the tension of the string.
- 15** A particle of mass 5 kg is suspended by two strings of lengths 5 cm and 12 cm respectively, attached at two points at the same horizontal level and 13 cm apart. Find the tension in the shorter string.
- 16** The angle between two forces 10 N and P N acting on a particle is 50° . A third force of magnitude 12 N holds the particle in equilibrium.
- Find the angle between the third force and the 10 N force.
Hint: Resolve the forces in a direction perpendicular to the P N force.
 - Hence find P .



17G Vector functions

The equation derived from Newton's second law, i.e. $\mathbf{F} = m\mathbf{a}$, is a vector equation. In this section, we use vector function notation in dynamics problems. The emphasis is on motion in a straight line.

Example 26

Forces $\mathbf{F}_1 = 2\mathbf{i} + 3\mathbf{j}$ and $\mathbf{F}_2 = 3\mathbf{i} - 4\mathbf{j}$ act on a particle of mass 2 which is at rest. Find:

- the acceleration of the particle
- the position of the particle at time t , given that initially it is at the point $3\mathbf{i} + 2\mathbf{j}$
- the Cartesian equation of the path of the particle.

(Assume mks system of units.)

Solution

- The resultant force acting on the particle is

$$\begin{aligned}\mathbf{F} &= \mathbf{F}_1 + \mathbf{F}_2 \\ &= 2\mathbf{i} + 3\mathbf{j} + 3\mathbf{i} - 4\mathbf{j} \\ &= 5\mathbf{i} - \mathbf{j}\end{aligned}$$

By Newton's second law:

$$\mathbf{F} = m\mathbf{a}$$

$$5\mathbf{i} - \mathbf{j} = 2\mathbf{a}$$

$$\therefore \mathbf{a} = \frac{5}{2}\mathbf{i} - \frac{1}{2}\mathbf{j}$$

b Let \mathbf{v} be the velocity at time t . Then

$$\frac{d\mathbf{v}}{dt} = \frac{5}{2}\mathbf{i} - \frac{1}{2}\mathbf{j}$$

$$\mathbf{v} = \frac{5}{2}t\mathbf{i} - \frac{1}{2}t\mathbf{j} + \mathbf{c}$$

Since $\mathbf{v} = \mathbf{0}$ when $t = 0$, we have $\mathbf{c} = \mathbf{0}$.

$$\therefore \mathbf{v} = \frac{5}{2}t\mathbf{i} - \frac{1}{2}t\mathbf{j}$$

Let \mathbf{r} be the position at time t . Then

$$\frac{d\mathbf{r}}{dt} = \frac{5}{2}t\mathbf{i} - \frac{1}{2}t\mathbf{j}$$

$$\mathbf{r} = \frac{5}{4}t^2\mathbf{i} - \frac{1}{4}t^2\mathbf{j} + \mathbf{d}$$

Since $\mathbf{r} = 3\mathbf{i} + 2\mathbf{j}$ when $t = 0$, we have $\mathbf{d} = 3\mathbf{i} + 2\mathbf{j}$.

$$\therefore \mathbf{r} = \left(3 + \frac{5}{4}t^2\right)\mathbf{i} + \left(2 - \frac{1}{4}t^2\right)\mathbf{j}$$

c Let $\mathbf{r}(t) = x(t)\mathbf{i} + y(t)\mathbf{j}$. Then

$$x(t) = 3 + \frac{5}{4}t^2 \quad \text{and} \quad y(t) = 2 - \frac{1}{4}t^2$$

Solve the first equation for t^2 and substitute in the second equation:

$$\begin{aligned} y &= 2 - \frac{1}{4}t^2 \\ &= 2 - \frac{1}{4}\left(\frac{4}{5}(x - 3)\right) \\ &= 2 - \frac{1}{5}(x - 3) \\ &= \frac{13}{5} - \frac{1}{5}x \end{aligned}$$

The motion is in the straight line with equation $y = \frac{13}{5} - \frac{1}{5}x$.



Example 27

At time t , the position of a particle of mass 3 kg is given by $\mathbf{r}(t) = 3t^3\mathbf{i} + 6(t^3 + 1)\mathbf{j}$. Find:

- the initial position of the particle
- the Cartesian equation describing the path of the particle
- the resultant force acting on the particle at time $t = 1$.

Solution

a When $t = 0$, $\mathbf{r}(0) = 0\mathbf{i} + 6\mathbf{j}$.

b Let $\mathbf{r}(t) = x(t)\mathbf{i} + y(t)\mathbf{j}$. Then

$$x = 3t^3 \quad \text{and} \quad y = 6t^3 + 6$$

$$\therefore t^3 = \frac{x}{3} \quad \text{and} \quad y = 2x + 6$$

The Cartesian equation of the path of the particle is $y = 2x + 6$.

c $\mathbf{r}(t) = 3t^3\mathbf{i} + 6(t^3 + 1)\mathbf{j}$

$$\dot{\mathbf{r}}(t) = 9t^2\mathbf{i} + 18t^2\mathbf{j}$$

$$\ddot{\mathbf{r}}(t) = 18t\mathbf{i} + 36t\mathbf{j}$$

When $t = 1$, $\ddot{\mathbf{r}}(1) = 18\mathbf{i} + 36\mathbf{j}$.

From Newton's second law of motion, we have $\mathbf{F} = m\ddot{\mathbf{r}}$.

Thus the resultant force \mathbf{F} at time $t = 1$ is $54\mathbf{i} + 108\mathbf{j}$.

Exercise 17G

Skillsheet

Example 26

- Forces $\mathbf{F}_1 = 2\mathbf{i}$ N and $\mathbf{F}_2 = -3\mathbf{j}$ N act on a particle of mass 1 kg which is initially at rest. Find:
 - the acceleration of the particle
 - the magnitude of the acceleration
 - the velocity of the particle at time t seconds
 - the speed of the particle after 1 second of motion
 - the direction of motion (measured anticlockwise from the direction of \mathbf{i}).
- A force of $(4\mathbf{i} + 6\mathbf{j})$ N acts on a particle of mass 2 kg. If the particle is initially at rest at the point with position vector $0\mathbf{i} + 0\mathbf{j}$, find:
 - the acceleration of the particle
 - the velocity of the particle at time t seconds
 - the position of the particle at time t seconds
 - the Cartesian equation of the path of the particle.

Example 27

- 3** At time t , the position of a particle of mass 2 kg is given by $\mathbf{r}(t) = 5t^2\mathbf{i} + 2(t^2 + 4)\mathbf{j}$.
Find:
- the initial position of the particle
 - the Cartesian equation describing the path of the particle
 - the resultant force acting on the particle at time t .
- 4** At time t , the position of a particle of mass 5 kg is given by $\mathbf{r}(t) = 5(5 - t^2)\mathbf{i} + 5(t^2 + 2)\mathbf{j}$.
Find:
- the initial position of the particle
 - the Cartesian equation describing the path of the particle
 - the resultant force acting on the particle at time t .
- 5** Forces $2\mathbf{i} + \mathbf{j}$ and $\mathbf{i} - 2\mathbf{j}$ act on a particle of mass 2 kg. The forces are measured in newtons. Find:
- the acceleration of the particle
 - the velocity of the particle at time t if it was originally at rest at the point with position vector $2\mathbf{i} - 2\mathbf{j}$
 - the position of the particle at time t .
- 6** A body of mass 10 kg changes velocity uniformly from $(3\mathbf{i} + \mathbf{j})$ m/s to $(27\mathbf{i} + 9\mathbf{j})$ m/s in 3 seconds.
- Find a vector expression for the acceleration of the body.
 - Find a vector expression for the constant resultant force acting on the body.
 - Find the magnitude of the force.
- 7** The position of a particle of mass 2 kg at time t is given by $\mathbf{r}(t) = 2t^2\mathbf{i} + (t^2 + 6)\mathbf{j}$.
- Find the Cartesian equation of the path of the particle.
 - Find the velocity of the particle at time t .
 - At what time is the speed of the particle $16\sqrt{5}$ m/s?
 - Find the resultant force acting on the particle at time t .
- 8** A particle of mass 10 kg moving with velocity $3\mathbf{i} + 5\mathbf{j}$ m/s is acted on by a force of $\frac{1}{10}(15\mathbf{i} + 25\mathbf{j})$ newtons. Find:
- the acceleration of the particle
 - the velocity at time t
 - the position of the particle when $t = 6$ if initially it is at the point with position vector $0\mathbf{i} + 0\mathbf{j}$
 - the Cartesian equation of the path of the particle.
- 9** A particle is moving along a path which can be described by the Cartesian equation $y = 3x$. If the speed of the particle in the positive x -direction is 5 m/s, what is the speed of the particle in the positive y -direction? Find the speed of the particle.



Chapter summary



- The units of force used are the kilogram weight and the newton.
1 kg wt = g N, where g is the magnitude of the acceleration due to gravity.
- The vector sum of the forces acting at a point is called the **resultant force**.
- A force acting on a body has an influence in directions other than its line of action, except in the direction perpendicular to its line of action.
- The **resolved part** of a force P N in a direction that makes an angle θ with its own line of action is a force of magnitude $P \cos \theta$.
- If a force is resolved in two perpendicular directions, then the vector sum of the resolved parts is equal to the force itself.
- The **momentum** of a particle is the product of its mass and velocity:

$$\text{momentum} = \text{mass} \times \text{velocity}$$

The units of momentum are kg m/s or kg ms⁻¹.

- **Newton's second law of motion**

$F = ma$, where force is measured in newtons, mass in kilograms and acceleration in m/s².

- The frictional force, F_R , on a particle moving on a surface is given by

$$F_R = \mu R$$

where R is the normal reaction force and μ is the coefficient of friction.

- **Triangle of forces**

If the forces P , Q and R are the only forces acting on a particle and the particle is in equilibrium, then these forces can be represented in magnitude and direction by a triangle of forces.

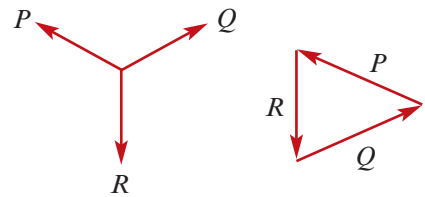

- **Lami's theorem**

If the particle is in equilibrium, then

$$\frac{P}{\sin p^\circ} = \frac{Q}{\sin q^\circ} = \frac{R}{\sin r^\circ}$$

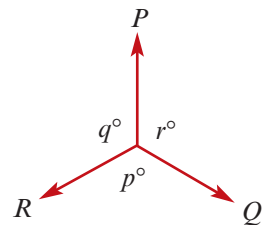

Short-answer questions

- 1 A man of mass 75 kg is in a lift of mass 500 kg that is accelerating upwards at 2 m/s².
 - a Find the force exerted by the floor on the man.
 - b Find the total tension in the cables raising the lift.
- 2 Masses of 3 kg and 5 kg are at the ends of a light string that passes over a smooth fixed peg. Calculate:
 - a the acceleration of the bodies
 - b the tension in the string.

- 4 A 5 kg mass and a 3 kg mass are connected by a string passing over a smooth pulley as shown. The magnitude of the acceleration of the system is

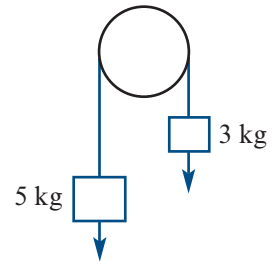

- A 0.25 m/s^2 B $\frac{g}{4} \text{ m/s}^2$ C $\frac{g}{2} \text{ m/s}^2$
 D 0.5 m/s^2 E $8g \text{ m/s}^2$

- 5 A body of mass m kg is being pulled along a smooth horizontal table by a string inclined at θ° to the vertical. The diagram shows the forces acting on the body. Which one of the following statements is true?

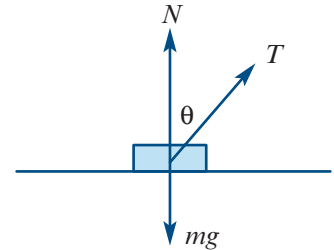

- A $N - mg = 0$
 B $N + T \sin \theta - mg = 0$
 C $N - T \sin \theta - mg = 0$
 D $N + T \cos \theta - mg = 0$
 E $N - T \cos \theta - mg = 0$
- 6 A boy slides down a smooth slide with an inclination to the horizontal of θ° , where $\sin \theta = \frac{4}{5}$. Let $g \text{ m/s}^2$ be the acceleration due to gravity. Then the boy's acceleration down the slide (in m/s^2) is given by

- A $\frac{3g}{5}$ B $\frac{4g}{5}$ C $40g$ D $\frac{200g}{3}$ E $30g$

- 7 Two forces of magnitude 10 N act on a particle at O as shown. The magnitude of the resultant force in newtons is

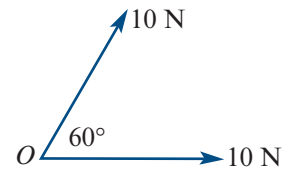

- A 20 B $10\sqrt{3}$ C 0
 D 10 E 5

- 8 The diagram shows the forces acting on a body as it moves with constant velocity across a rough horizontal surface: W newtons is the weight force, N newtons is the normal reaction of the surface on the body, F newtons is the frictional force, and T newtons is the tension in a string attached to the body and inclined at an angle θ to the horizontal.

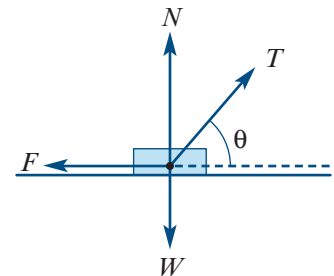

The coefficient of friction between the body and the surface is given by

- A $\frac{T \sin \theta}{W - T \cos \theta}$ B $\frac{T \cos \theta}{W - T \sin \theta}$
 C $\frac{T \cos \theta}{W}$ D $\frac{T \cos \theta}{W + T \sin \theta}$
 E $\frac{W - T \sin \theta}{T \cos \theta}$

- 9 The external resultant force on a body is zero. Which one of the following statements cannot be true?
- A** The body has constant momentum. **B** The body is moving in a circle.
C The body is moving in a straight line. **D** The body has constant velocity.
E The body is not moving.
- 10 A particle of mass 9 kg, pulled along a rough horizontal surface by a horizontal force of 54 N, is moving with an acceleration of 2 m/s^2 . The coefficient of sliding friction between the body and the surface is closest to
- A** 0.08 **B** 0.33 **C** 0.41 **D** 0.82 **E** 2.45



Extended-response questions

- 1 A buoy of mass 4 kg is held 5 metres below the surface of the water by a vertical cable. There is an upwards buoyancy force of 42 N acting on the buoy.
- Find the tension in the cable.
 - Suddenly the cable breaks. Find the acceleration of the buoy while it is still in the water.
 - The buoy maintains this constant acceleration while it is still in the water. Find:
 - the time taken for it to reach the surface
 - the velocity of the buoy at this time.
 - Ignoring air resistance, find the height above water level that the buoy will reach.
- 2 Masses of 2.8 kg, 2.2 kg and 3 kg are connected by light inextensible strings, one of which passes over a smooth fixed pulley, as shown in the diagram.
- If the system is released from rest, calculate:
 - the acceleration of the masses
 - the tension in the string joining the 2.2 kg and 3 kg masses.
 - If after $1\frac{1}{2}$ seconds the string joining the 2.2 kg and 3 kg masses breaks, calculate the further distance that the 2.2 kg mass falls before coming instantaneously to rest.
- 3 A mass of 400 g, hanging vertically, drags a mass of 200 g across a horizontal table. The coefficient of friction is 0.4.
- Find the acceleration of the system.
 - Find the tension in the string connecting the two masses.
 - If the falling weight strikes the floor after moving 150 cm, how far will the mass on the table move afterwards? (Assume that there is enough table surface for the mass to continue on the table until it stops.)

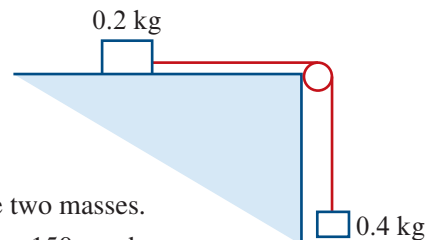
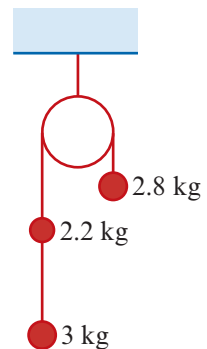

- 4** An engine of mass 60 000 kg is pulling a truck of mass 12 000 kg at constant speed up a slope inclined at α to the horizontal, where $\sin \alpha = \frac{1}{200}$.

Resistances are 50 N per 1000 kg for the engine, and 30 N per 1000 kg for the truck.

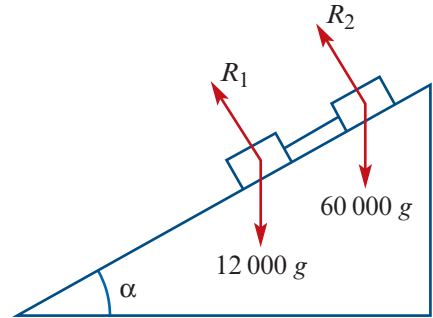

- a** Calculate:
- i** the tractive force exerted by the engine
 - ii** the tension in the coupling between the engine and the truck.
- b** If the engine and the truck were accelerating at 0.1 m/s^2 up the slope, find:
- i** the tractive force exerted by the engine
 - ii** the tension in the coupling between the engine and the truck.
- 5** The total resistance on a train with the brakes applied is $(a + bv^2)$ per unit mass, where v is its velocity.
- a i** Show that $\frac{dv}{dx} = -\frac{(a + bv^2)}{v}$, where x is the distance travelled from when the brakes were first applied.
- ii** If u is the velocity of the train when the brakes are first applied, show that the train comes to rest when $x = \frac{1}{2b} \ln\left(1 + \frac{bu^2}{a}\right)$.

b i Show that the train stops when $t = \frac{1}{\sqrt{ab}} \tan^{-1}\left(\frac{\sqrt{b}u}{\sqrt{a}}\right)$.

- ii** Find the time it takes for the train to stop if $b = 0.005$, $a = 2$ and $u = 25$.

- 6** A particle of mass m kg falls vertically from rest in a medium in which the resistance is $0.02 mv^2$ N when the velocity is v m/s.

a Find the distance, x m, which the particle has fallen in terms of v .

b Find v in terms of x . **c** Sketch the graph of v against x .

- 7** The diagram shows a crate of mass M kg on a rough inclined slope and a block of mass 200 kg hanging vertically 50 m above the ground. The crate and the block are joined by a light inelastic rope which passes over a smooth pulley at A .

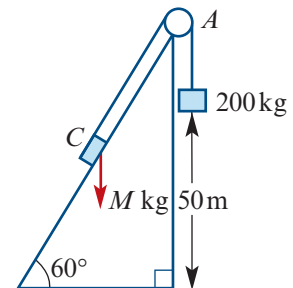

a If $M = 200$ and C is moving up the plane with constant speed, find the coefficient of friction μ between C and the slope.

b Find the values of M for which the crate will remain stationary.

c Let $M = 150$.

i Find the acceleration of the system. **ii** Find the tension in the rope.

iii If after 2 seconds of motion the string breaks, find the speed of the 200 kg block when it hits the ground.

- 8** The velocity, v m/s, of a vehicle moving in a straight line is $v = 125(1 - e^{-0.1t})$ m/s at time t seconds. The mass of the vehicle is 250 kg.
- Find the acceleration of the vehicle at time t .
 - The resultant force acting on the vehicle is $(P - 20v)$ N, where P N is the driving force and $20v$ N is the resistance force.
 - Find P in terms of t .
 - Find P in terms of v .
 - Find P when $v = 20$.
 - Find P when $t = 30$.
 - Sketch the graph of P against t .

- 9** A particle of mass M kg is being pulled up a rough inclined plane at constant speed by a force of T N as shown. The coefficient of friction is 0.1.

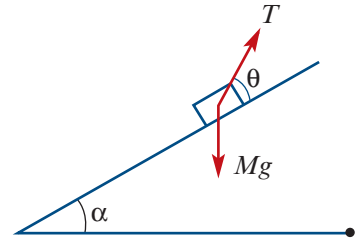

- Find the normal reaction force R in terms of M , T , θ and α .
- Find T in terms of θ , α and M .
- Assume that $\sin \alpha = \frac{4}{5}$ and $M = 10$.
 - Find T in terms of θ .
 - Find the value of θ which minimises T .
 - State this minimum value of T .
- If the particle is now accelerating up the plane at 2 m/s^2 , find the value of θ which minimises T . (Continue to assume that $\sin \alpha = \frac{4}{5}$ and $M = 10$.)

- 10** A particle of mass 50 kg slides down a rough plane inclined at θ° to the horizontal. The coefficient of friction between the particle and the plane is 0.1. The length of the plane is 10 m and $\sin \theta = \frac{5}{13}$.

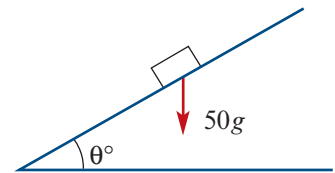

- Find the values of:
 - R , the normal reaction force
 - F , the friction force.
- Find the acceleration of the particle down the plane.
- If the particle starts at the top of the plane and slides down, find:
 - the speed of the particle at the bottom of the plane
 - the time it takes to reach the bottom of the plane.
- If an extra force P N, where $P = 300 - 250t$, is acting parallel to the line of greatest slope of the plane, find:
 - the acceleration of the particle at time t
 - the time it takes to reach the bottom of the plane from the top of the plane. (Time t is measured from when motion starts.)

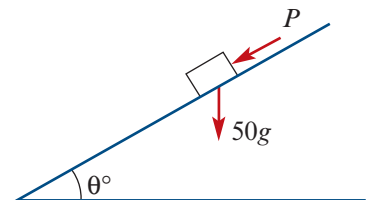

18

Revision of Chapters 16–17

18A Short-answer questions

- 1 The position of a particle at time t seconds, relative to an origin O , is given by

$$\mathbf{r}(t) = \sin(t)\mathbf{i} + \frac{1}{2}\sin(2t)\mathbf{j}, \quad t \geq 0$$

- a** Find the velocity of the particle at time t .
b Find the acceleration at time t .
c Find an expression for the distance of the particle from the origin at time t in terms of $\sin(t)$.
d Find an expression for the speed of the particle at time t in terms of $\sin(t)$.
e Find the Cartesian equation of the path of the particle.
- 2 **a** A 50 kg person stands in a lift which accelerates downwards at 1 m/s^2 . Find the reaction of the lift floor on the person.
b Find the reaction of the lift floor on the person when the lift accelerates upwards at 1 m/s^2 .
- 3 A body of mass 10 kg, on a horizontal plane, is initially at rest and is acted upon by a resultant force of $v - 5$ newtons, where $v \text{ m/s}$ is the speed of the body. The body will move in a straight line.
a Find the acceleration of the body at time t in terms of v .
b Find v in terms of t .
- 4 A body of mass 5 kg is held in place on a smooth plane inclined at 30° to the horizontal by a string with a tension force $T \text{ N}$, acting parallel to the plane. Find the value of T .

- 5** The position vector of a particle moving relative to the origin at time t seconds is given by $\mathbf{r}(t) = 2 \sec(t) \mathbf{i} + \frac{1}{2} \tan(t) \mathbf{j}$, for $t \in \left[0, \frac{\pi}{2}\right)$.
- Find the Cartesian equation of the path.
 - Find the velocity of the particle at time t .
 - Find the speed of the particle when $t = \frac{\pi}{3}$.
- 6** The acceleration of an object is inversely proportional to its velocity at any time t seconds. The object is travelling at 1 m/s when its acceleration is 2 m/s^2 . The velocity of the particle when $t = 0$ was 2 m/s to the left. Find its velocity at time t seconds.
- 7** A particle moves such that, at time t seconds, the velocity, \mathbf{v} m/s, is given by $\mathbf{v} = e^{2t} \mathbf{i} - e^{-2t} \mathbf{k}$. Given that, at $t = 0$, the position of the particle is $\mathbf{i} + \mathbf{j} - 2\mathbf{k}$, find the position at $t = \ln 2$.
- 8** A particle has acceleration, $\mathbf{a} \text{ m/s}^2$, given by $\mathbf{a} = -g\mathbf{j}$, where \mathbf{j} is a unit vector vertically upwards. Let \mathbf{i} be a horizontal unit vector in the plane of the particle's motion. The particle is projected from the origin with an initial speed of 20 m/s at an angle of 60° to the horizontal.
- Prove that the velocity, in m/s, at t seconds is given by $\mathbf{v} = 10\mathbf{i} + (10\sqrt{3} - gt)\mathbf{j}$.
 - Hence find the Cartesian equation of the path of the particle.
- 9** Two forces \mathbf{P} and \mathbf{Q} act in the directions of the vectors $4\mathbf{i} + 3\mathbf{j}$ and $\mathbf{i} - 2\mathbf{j}$ respectively and the magnitude of \mathbf{P} is 25 newtons. If the magnitude of the resultant of \mathbf{P} and \mathbf{Q} is also 25 newtons, find the magnitude of \mathbf{Q} .
- 10** Two blocks of mass 4 kg and 15 kg, formed from identical material, are attached to each other by a light inextensible string as shown below. The blocks are pulled along by a horizontal force of magnitude 25 N.

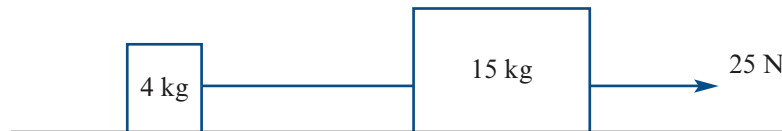

- Find the tension in the string if the surface is smooth.
 - Find the acceleration of the two blocks if the surface is rough and the coefficient of friction between the horizontal surface and the blocks is 0.5.
- 11** This diagram shows an object of mass 10 kg which has been projected up a rough plane inclined at 30° to the horizontal. The initial speed of the object was 8 m/s and the coefficient of friction between the surface of the plane and the object is 0.25. Find the time it takes for the object to come to rest.

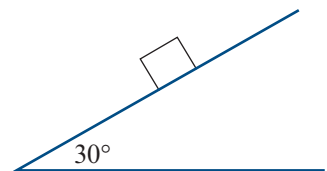

- 12** A body of mass m kg is projected with an initial speed of u m/s up a rough plane, with the coefficient of friction μ between the plane and the body. The body travels x metres before coming to rest. The plane is inclined at θ° to the horizontal.
- Express μ in terms of u , x , θ and g .
 - If the initial speed was increased by 20%, what effect would this have on the distance moved up the plane, with μ and θ kept constant?

- 13** The velocity, \mathbf{v} , of a particle at time t seconds is given by

$$\mathbf{v}(t) = -2 \sin(2t) \mathbf{i} + 2 \cos(2t) \mathbf{j}, \quad 0 \leq t \leq 2\pi$$

The particle moves in the horizontal plane. Let \mathbf{i} be the unit vector in the easterly direction and \mathbf{j} be the unit vector in the northerly direction. Find:

- the position vector, $\mathbf{r}(t)$, given that $\mathbf{r}(0) = 2\mathbf{i} - \mathbf{j}$
 - the Cartesian equation of the path of the particle
 - the time(s) when the particle is moving in the westerly direction.
- 14** A particle is projected from the origin so that the position vector, $\mathbf{r}(t)$ metres, at time t seconds, $t \geq 0$, is given by

$$\mathbf{r}(t) = 14\sqrt{3}t \mathbf{i} + \left(14t - \frac{g}{2}t^2\right) \mathbf{j}$$

where \mathbf{i} is the unit vector in the direction of the x -axis, horizontally, and \mathbf{j} is the unit vector in the direction of the y -axis, vertically. The x -axis represents ground level. Find:

- the time (in seconds) taken for the particle to reach the ground, in terms of g
 - the Cartesian equation of the parabolic path
 - the maximum height reached by the particle (in metres), in terms of g .
- 15** A person hangs a heavy mirror on a vertical wall by attaching a light inextensible wire to two points A and B on the wall, which are on the same horizontal level and 100 cm apart. The wire is then attached to the back of the mirror at its centre of gravity at point C , as shown in the diagram. The weight of the mirror is 10 kg wt. The sections of the wire, AC and BC , are each of length 75 cm, so that the tension, T kg wt, in each wire is equal. Find T .

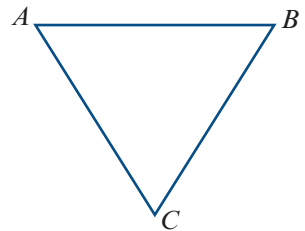

18B Multiple-choice questions

1 The velocity, V , of a body is given by $V = (x - 2)^2$, where x is the position of the body at time t . The acceleration of the body at time t is given by

- A $2(x - 2)$ B $\frac{(x - 2)^2}{t}$ C $2(x - 2)^3$ D $x^2 - 4x + 4$ E $x - 4$

2 A particle of weight 20 kg wt is supported by two wires attached to a horizontal beam. The tensions in the wires are T_1 kg wt and T_2 kg wt. Which one of the following statements is not true?

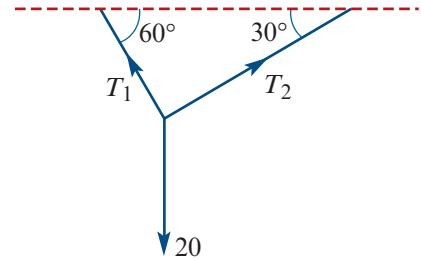

- A $\frac{T_1}{\sin 60^\circ} = \frac{T_2}{\sin 30^\circ}$ B $T_2 = 20 \sin 30^\circ$
 C $T_1 = 20 \cos 30^\circ$ D $T_1 \cos 60^\circ = T_2 \cos 30^\circ$
 E $T_1 \cos 60^\circ + T_2 \cos 30^\circ = 20$

3 The diagram shows three masses, in equilibrium, connected by strings over smooth fixed pulleys.

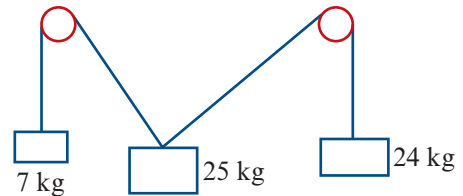

Which one of the following force diagrams is an accurate representation of the forces acting on the 25 kg mass?

- A
- B
- C
- D
- E

4 The system shown rests in equilibrium, with the string passing over a smooth pulley. The other parts of the string are vertical. When the string connecting P and Q is cut, the acceleration of R is of magnitude

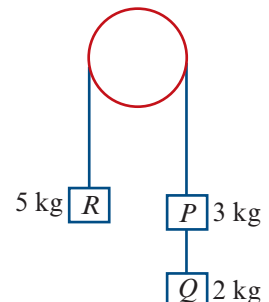

- A $\frac{g}{4}$ B g C $\frac{15g}{4}$ D $4g$ E none of these

- 5** A particle, P , of unit mass moves under a resisting force $-kv$, where k is a positive constant and v is the velocity of P . No other forces act on P , which has velocity V at time $t = 0$. At time t , the velocity of the particle is
A Ve^{kt} **B** $\left(\frac{V}{k}\right)e^{kt}$ **C** Ve^{-kt} **D** $\left(\frac{V}{k}\right)e^{-kt}$ **E** $V(1 - kt)$
- 6** A particle of mass m lies on a horizontal platform that is being accelerated upwards with an acceleration f . The force exerted by the platform on the particle is
A $m(f - g)$ **B** $m(g + f)$ **C** $m(g - f)$ **D** $\frac{mf}{g}$ **E** mf
- 7** A particle of mass 10 kg is subject to forces of $3\mathbf{i}$ newtons and $4\mathbf{j}$ newtons. The acceleration of the particle is described by the vector
A $5\mathbf{i}$ **B** $0.3\mathbf{i} + 0.4\mathbf{j}$ **C** $\frac{5}{\sqrt{2}}(\mathbf{i} + \mathbf{j})$ **D** $5\mathbf{j}$ **E** $3\mathbf{i} + 4\mathbf{j}$
- 8** A particle moves in the x - y plane such that its position vector \mathbf{r} at time t seconds is given by $\mathbf{r} = 2t^2\mathbf{i} + t^3\mathbf{j}$ metres. When $t = 1$, the speed of the particle (in m/s) is
A $\frac{3}{4}$ **B** $\sqrt{5}$ **C** 5 **D** 7 **E** 25
- 9** A body falls, under gravity, against a resistance of kv^2 per unit mass, where v is the speed and k is a constant. After time t , the body has fallen a distance s . Which of the following equations describes the motion?
A $v \frac{dv}{ds} = g - kv^2$ **B** $v \frac{dv}{dt} = g + kv^2$ **C** $\frac{d^2s}{dt^2} = g + kv^2$
D $v \frac{dv}{ds} = -(g + kv^2)$ **E** $\frac{dv}{dt} = -g + kv^2$
- 10** A particle moves in the x - y plane such that its position vector \mathbf{r} at time t seconds is given by $\mathbf{r} = \sin(2t)\mathbf{i} + e^{-t}\mathbf{j}$ metres. When $t = 0$, the speed of the particle (in m/s) is
A 1 **B** 3 **C** $\sqrt{3}$ **D** $\sqrt{5}$ **E** 5
- 11** A block of weight w slides down a fixed slope of angle θ , where $\tan \theta = \frac{3}{4}$. The coefficient of friction is $\frac{1}{2}$. The horizontal component of the resultant force acting on the block is
A 0 **B** $\frac{w}{4}$ **C** $\frac{2w}{5}$ **D** $\frac{6w}{25}$ **E** $\frac{4w}{25}$
- 12** A particle starts at rest at a point O and moves in a straight line so that, after t seconds, its velocity, v , is given by $v = 4 \sin(2t)$. At this time the displacement, s , from O is given by
A $s = 8 \cos(2t)$ **B** $s = 2 \cos(2t)$ **C** $s = -2 \cos(2t)$
D $s = 8 \cos(2t) - 8$ **E** $s = 2 - 2 \cos(2t)$
- 13** A boy of mass 60 kg slides down a frictionless slope that is inclined at θ° to the horizontal, where $\sin \theta = \frac{4}{5}$. The boy's acceleration down the slide (in m/s^2) is
A $\frac{3}{5}g$ **B** $\frac{4}{5}g$ **C** $36g$ **D** $48g$ **E** g

- 14** The position of a particle at time $t = 0$ is $\mathbf{r}(0) = 2\mathbf{i} + 5\mathbf{j} + 2\mathbf{k}$, and its position at time $t = 2$ is $\mathbf{r}(2) = 4\mathbf{i} - \mathbf{j} + 4\mathbf{k}$. The average velocity for the interval $[0, 2]$ is
- A** $\frac{1}{2}(6\mathbf{i} + 4\mathbf{j} + 6\mathbf{k})$ **B** $\mathbf{i} - 3\mathbf{j} + \mathbf{k}$ **C** $24\mathbf{i} + \mathbf{k}$
D $\mathbf{i} - 2\mathbf{j} + 3\mathbf{k}$ **E** $\frac{1}{2}\mathbf{i} - \frac{3}{2}\mathbf{j} + \frac{1}{2}\mathbf{k}$

- 15** The diagram shows a particle of weight W on an inclined plane. The normal force exerted by the plane is N , and the friction force is F . The force P pulls the particle up the plane at a constant speed. Which one of the following is true?

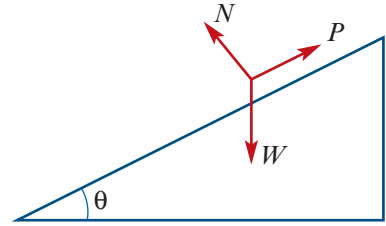

- A** $P = W \sin \theta - F$ **B** $P = F + W \sin \theta$
C $P = F$ **D** $N = W \sin \theta$
E $W = N \cos \theta$
- 16** The acceleration of a particle at time t is given by $\ddot{\mathbf{x}}(t) = 2\mathbf{i} + t\mathbf{j}$. If the velocity of the particle at time $t = 0$ is described by the vector $2\mathbf{i}$, then the velocity at time t is
- A** $\dot{\mathbf{x}}(t) = 2t\mathbf{i} + \frac{1}{2}t^2\mathbf{j}$ **B** $\dot{\mathbf{x}}(t) = (2t + 2)\mathbf{i} + \frac{1}{2}t^2\mathbf{j}$ **C** $\dot{\mathbf{x}}(t) = 2\mathbf{i} + (2\mathbf{i} + t\mathbf{j})t$
D $\dot{\mathbf{x}}(t) = 2(2\mathbf{i} + t\mathbf{j})$ **E** $\dot{\mathbf{x}}(t) = 2 + 2t\mathbf{i} + \frac{1}{2}t^2\mathbf{j}$

- 17** A mass is hanging in a lift, being suspended by a light inextensible string. The lift ascends, first moving with uniform acceleration, then with uniform speed, and finally retarding to rest with a retardation of the same magnitude as the acceleration. Given that the tension, T , is greater than zero throughout, which of the following is the graph that best represents T against t ?

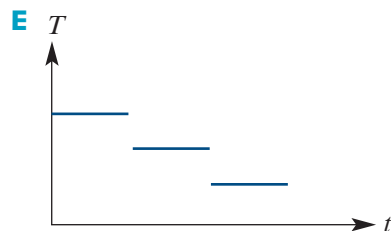
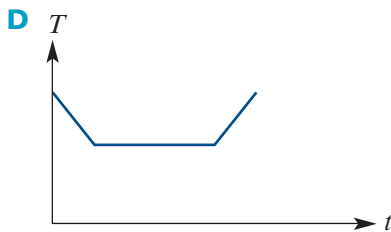
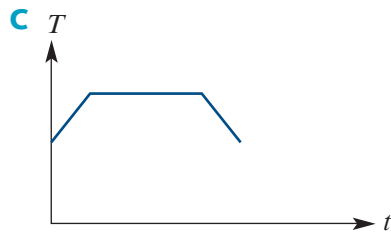
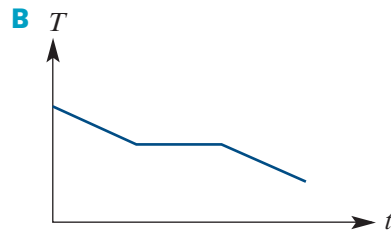
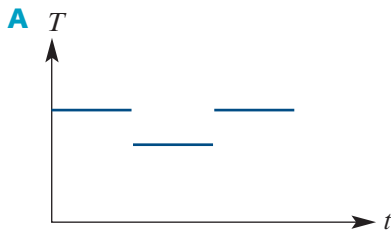

- 18** A projectile is launched at an angle of 60° to the horizontal with an initial speed of 30 m/s. What is the magnitude of the horizontal component of the projectile's displacement at the end of 2 seconds?
A 30 m **B** 40 m **C** 10 m **D** 20 m **E** 50 m
- 19** A particle is moving so its velocity vector at time t is $\dot{\mathbf{r}}(t) = 2t\mathbf{i} + 3\mathbf{j}$, where $\mathbf{r}(t)$ is the position vector of the particle at time t . If $\mathbf{r}(0) = 3\mathbf{i} + \mathbf{j}$, then $\mathbf{r}(t)$ is equal to
A $2\mathbf{i}$ **B** $5\mathbf{i} + 3\mathbf{j}$ **C** $(3t + 1)\mathbf{i} + (3t^2 + 1)\mathbf{j}$
D $(t^2 + 3)\mathbf{i} + (3t + 1)\mathbf{j}$ **E** $2t^2\mathbf{i} + 3t\mathbf{j} + 3\mathbf{i} + \mathbf{j}$
- 20** A particle of mass 5 kg is subjected to forces of $3\mathbf{i}$ newtons and $4\mathbf{j}$ newtons. The magnitude of the particle's acceleration is equal to
A 1 m/s^2 **B** 7 m/s^2 **C** 1.2 m/s^2 **D** -1.2 m/s^2 **E** 5 m/s^2
- 21** A body is in equilibrium under the action of forces \mathbf{F}_1 , \mathbf{F}_2 and \mathbf{F}_3 , where $\mathbf{F}_1 = 3\mathbf{i} + 2\mathbf{j} + \mathbf{k}$ and $\mathbf{F}_2 = \mathbf{i} - 2\mathbf{j}$. The force \mathbf{F}_3 is
A $4\mathbf{i} + \mathbf{k}$ **B** $2\mathbf{i} + 4\mathbf{j} + \mathbf{k}$ **C** $3\mathbf{i} + 4\mathbf{j} + \mathbf{k}$ **D** \mathbf{i} **E** $-4\mathbf{i} - \mathbf{k}$
- 22** A particle of mass m kg is moving with constant velocity down a plane inclined at θ° to the horizontal. The frictional force in newtons is
A $m \cos \theta$ **B** $mg \sin \theta$ **C** $mg \tan \theta$ **D** mg **E** $mg \cos \theta$
- 23** An object slides across a smooth horizontal tabletop of height h m at a constant speed of u m/s. It slides off the edge of the tabletop and hits the floor a distance of x m away. What is the relationship between x and h ?
A $h = \frac{ux}{g}$ **B** $x = \frac{u^2}{2gh}$ **C** $x = \frac{u^2}{gh}$
D $x = u\sqrt{\frac{2h}{g}}$ **E** $x = \frac{uh}{g}$
- 24** The particle P is in equilibrium under the action of forces, as shown in the diagram. The magnitude of angle θ is
A $\sin^{-1}\left(\frac{3}{5}\right)$ **B** $\cos^{-1}\left(\frac{3}{5}\right)$ **C** $\tan^{-1}\left(\frac{3}{5}\right)$
D $\frac{\pi}{2}$ **E** $\tan^{-1}\left(\frac{4}{3}\right)$

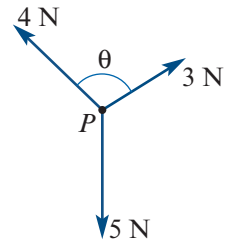

- 27** Two forces of 7 N and 3 N act at a point as shown in the diagram. The magnitude of the resultant force (in newtons) is

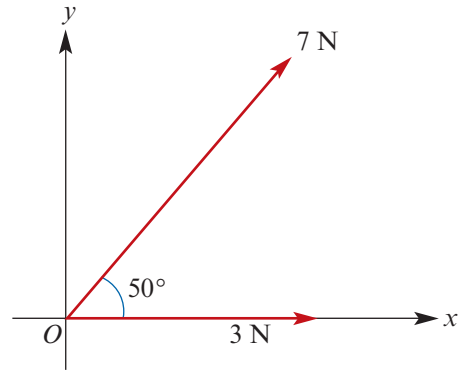

- A** 10
- B** $7 + 3 \cos 50^\circ$
- C** $3 + 7 \cos 50^\circ$
- D** $10 \cos 25^\circ$
- E** none of these

- 28** Two forces of 3 N and 2 N act at a point as shown in the diagram. The resultant of these forces makes an angle θ with the positive direction of the x -axis. Which one of the following is true?

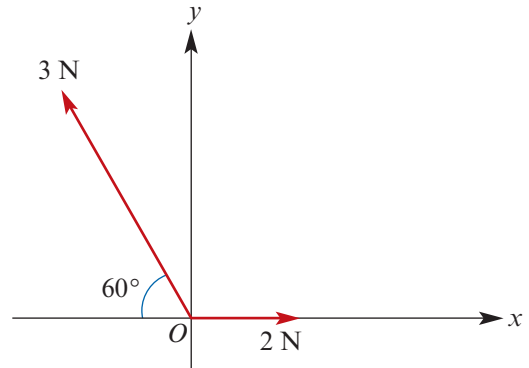

- A** $\cos \theta = \frac{2}{3}$
- B** $\theta = 60^\circ$
- C** $\tan \theta = 3\sqrt{3}$
- D** $\theta = 90^\circ$
- E** $\sin \theta = \frac{6\sqrt{3}}{\sqrt{107}}$

- 29** A particle of mass m kg slides down a rough plane inclined at an angle θ to the horizontal. The coefficient of friction between the particle and the plane is μ . The magnitude of the resultant of all the forces acting on the particle is

- A** $mg - \mu$
- B** $mg \sin \theta - \mu$
- C** $mg(\cos \theta - \sin \theta)$
- D** $mg(\sin \theta - \mu \cos \theta)$
- E** $mg(\cos \theta - \mu \sin \theta)$

- 30** Two particles of 5 kg and 3 kg are connected by a string that passes over a smooth pulley, and are then released. The magnitude of the acceleration of the particles is

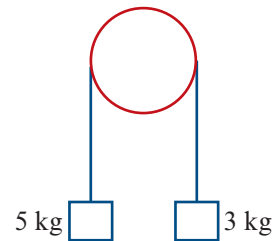

- A** 1 m/s^2
- B** $\frac{1}{4} \text{ m/s}^2$
- C** $g \text{ m/s}^2$
- D** $\frac{g}{4} \text{ m/s}^2$
- E** 0

- 31** A particle of weight 4 N is held in equilibrium on a smooth slope by a string that passes over a smooth pulley and is tied to a suspended particle of weight 3 N. Correct to one decimal place, the angle θ

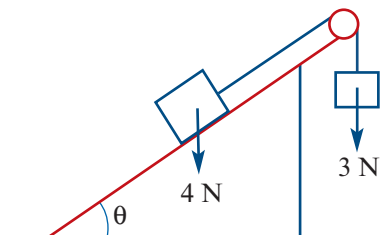

- A** is 48.6°
- B** is 41.4°
- C** is 36.9°
- D** is 53.1°
- E** does not exist

- 32** A particle has its position in metres from a given point at time t seconds defined by the vector $\mathbf{r}(t) = 4t\mathbf{i} - \frac{1}{3}t^2\mathbf{j}$. The magnitude of the displacement in the third second is
A 4 m **B** $3\frac{2}{3}$ m **C** $4\frac{1}{3}$ m **D** $6\frac{2}{3}$ m **E** 9 m

- 33** The position of a particle at time t seconds is given by $\mathbf{r}(t) = (t^2 - 2t)(\mathbf{i} - 2\mathbf{j} + 2\mathbf{k})$, measured in metres from a fixed point. The distance travelled by the particle in the first 2 seconds is
A 0 m **B** 2 m **C** -2 m **D** 6 m **E** 10 m

- 34** The position of a particle at time t seconds is given by the vector

$$\mathbf{r}(t) = \left(\frac{1}{3}t^3 - 4t^2 + 15t\right)\mathbf{i} + \left(t^3 - \frac{15}{2}t^2\right)\mathbf{j}$$

When the particle is instantaneously at rest, its acceleration vector is given by

- A** $15\mathbf{i}$ **B** $-18\mathbf{j}$ **C** $2\mathbf{i} + 15\mathbf{j}$ **D** $-8\mathbf{i} - 15\mathbf{j}$ **E** $-2\mathbf{i} + 3\mathbf{j}$
- 35** A particle moves with its position defined with respect to time t by the vector function $\mathbf{r}(t) = (3t^3 - t)\mathbf{i} + (2t^2 + 1)\mathbf{j} + 5t\mathbf{k}$. When $t = \frac{1}{2}$, the magnitude of the acceleration is
A 12 **B** 17 **C** $4\sqrt{3}$ **D** $4\sqrt{5}$ **E** none of these

- 36** The velocity of a particle is given by the vector $\dot{\mathbf{r}}(t) = \sin(t)\mathbf{i} + \cos(2t)\mathbf{j}$. At time $t = 0$, the position of the particle is given by the vector $6\mathbf{i} - 4\mathbf{j}$. The position of the particle at time t is given by

- A** $(6 - \cos t)\mathbf{i} + \left(\frac{1}{2}\sin(2t) + 4\right)\mathbf{j}$ **B** $(5 - \cos t)\mathbf{i} + \left(\frac{1}{2}\sin(2t) - 3\right)\mathbf{j}$
C $(5 + \cos t)\mathbf{i} + (2\sin(2t) - 4)\mathbf{j}$ **D** $(6 + \cos t)\mathbf{i} + (2\sin(2t) - 4)\mathbf{j}$
E $(7 - \cos t)\mathbf{i} + \left(\frac{1}{2}\sin(2t) - 4\right)\mathbf{j}$

- 37** The initial position, velocity and constant acceleration of a particle are given by $2\mathbf{i}$, $3\mathbf{j}$ and $\mathbf{i} - \mathbf{j}$ respectively. The position of the particle at time t is given by

- A** $(4 + t)\mathbf{i} + (3 - \frac{1}{2}t^2)\mathbf{j}$ **B** $2\mathbf{i} + 3t\mathbf{j}$ **C** $2t\mathbf{i} + 3t\mathbf{j}$
D $(2 + \frac{1}{2}t^2)\mathbf{i} + (3t - \frac{1}{2}t^2)\mathbf{j}$ **E** $(2 + t)\mathbf{i} + (3 - t)\mathbf{j}$

- 38** A particle of weight 1 N is supported by two wires attached to a horizontal beam. The tensions in the wires are T_1 N and T_2 N. Which of the following statements is *not* true?

- A** $\frac{T_1}{\sin 50^\circ} = \frac{T_2}{\sin 40^\circ}$
B $T_1 = \sin 50^\circ$
C $T_2 = \cos 50^\circ$
D $T_1 \cos 50^\circ + T_2 \cos 40^\circ = 1$
E $T_1 \cos 50^\circ = T_2 \cos 40^\circ$

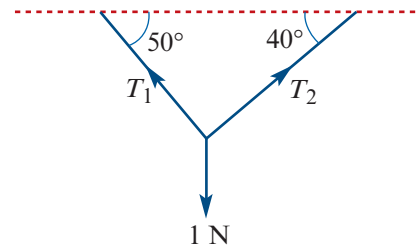

- 39** A particle of mass 5 kg has its momentum defined by the vector $30\mathbf{i} - 15\mathbf{j} + 10\mathbf{k}$ kg m/s. The magnitude of the velocity of the particle is
A 25 m/s **B** 5 m/s **C** 7 m/s **D** $\sqrt{31}$ m/s **E** 11 m/s

18C Extended-response questions

- 1 The position vector of a particle at time t seconds is given by $\mathbf{r}_1(t) = 2t\mathbf{i} - (t^2 + 2)\mathbf{j}$, where distances are measured in metres.
- What is the average velocity of the particle for the interval $[0, 10]$?
 - By differentiation, find the velocity at time t .
 - In what direction is the particle moving when $t = 3$?
 - When is the particle moving with minimum speed?
 - At what time is the particle moving at the average velocity for the first 10 seconds?
 - A second particle has its position at time t given by $\mathbf{r} = (t^3 - 4)\mathbf{i} - 3t\mathbf{j}$. Are the two particles coincident at any time t ?

- 2 A particle of mass m is on a rough plane, inclined at an angle α to the horizontal. The particle is connected by a light inextensible string that passes over a smooth pulley at the top of the plane to another particle of mass $2m$ that hangs vertically.

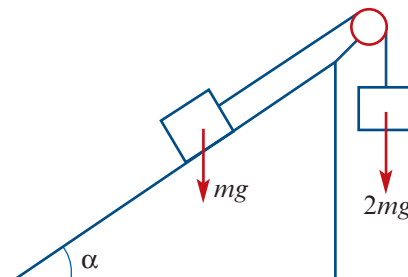

- Find the coefficient of friction if the lighter particle is moving up the plane with constant velocity.
 - If a particle of mass $3m$ is attached to the particle hanging vertically, find the acceleration of the particles.
 - Find the time for the particle to go 2 metres up the slope (starting from rest).
- 3 The acceleration vector, $\ddot{\mathbf{r}}(t)$ m/s², of a particle at time t seconds is given by $\ddot{\mathbf{r}}(t) = -16(\cos(4t)\mathbf{i} + \sin(4t)\mathbf{j})$.
- Find the position vector, $\mathbf{r}(t)$ m, given that $\dot{\mathbf{r}}(0) = 4\mathbf{j}$ and $\mathbf{r}(0) = \mathbf{j}$.
 - Show that the path of the particle is a circle and state the position vector of its centre.
 - Show that the acceleration is always perpendicular to the velocity.

- 4 An ice-skater describes an elliptic path. His position at time t seconds is given by

$$\mathbf{r} = 18 \cos\left(\frac{t}{3}\right)\mathbf{i} + 13.5 \sin\left(\frac{t}{3}\right)\mathbf{j}$$

When $t = 0$, $\mathbf{r} = 18\mathbf{i}$.

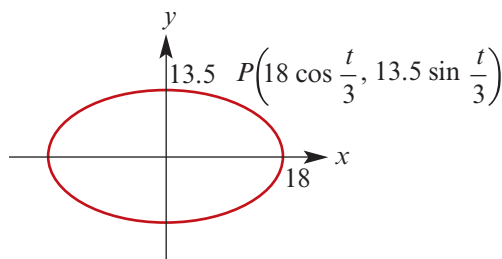

- How long does the skater take to go around the path once?
- Find the velocity of the ice-skater at $t = 2\pi$.
 - Find the acceleration of the ice-skater at $t = 2\pi$.
- Find an expression for the speed of the ice-skater at time t .
 - At what time is his speed greatest?
- Prove that the acceleration satisfies $\ddot{\mathbf{r}} = k\mathbf{r}$, and hence find when the acceleration has a maximum magnitude.

- 5** The diagram shows a block of mass 3 kg resting on a rough plane inclined at an angle α to the horizontal, where $\tan \alpha = \frac{4}{3}$. This block is connected by a light inextensible string that passes over a smooth pulley to a block of mass 2 kg resting on an equally rough plane inclined at an angle of $(90^\circ - \alpha)$ to the horizontal. Both parts of the string lie in a vertical plane that meets each of the inclined planes in a line of greatest slope.

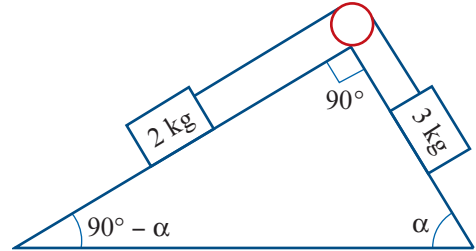

- a** If the 3 kg block is sliding down the plane with constant velocity, show that the coefficient of friction, μ , between the blocks and the planes is $\frac{6}{17}$.
- b** If an 8 kg mass is added to the 2 kg mass, find the acceleration of the system and the tension in the string.
- 6 a** The velocity vector of a particle P at time t is $\dot{\mathbf{r}}_1(t) = 3 \cos(2t) \mathbf{i} + 4 \sin(2t) \mathbf{j}$, where $\mathbf{r}_1(t)$ is the position relative to O at time t . Find:
- $\mathbf{r}_1(t)$, given that $\mathbf{r}_1(0) = -2\mathbf{j}$
 - the acceleration vector at time t
 - the times when the position and velocity vectors are perpendicular
 - the Cartesian equation of the path.
- b** At time t , a second particle Q has a position vector (relative to O) given by $\mathbf{r}_2(t) = \frac{3}{2} \sin(2t) \mathbf{i} + 2 \cos(2t) \mathbf{j} + (a - t) \mathbf{k}$. Find the possible values of a in order for the particles to collide.

- 7** A particle A of mass 1 kg is placed on a smooth plane inclined at 30° . It is attached by a light inelastic string to a particle B of mass 1 kg. The string passes over a smooth pulley and the particle B hangs 1 m from the floor. The particles are released from rest. Find:

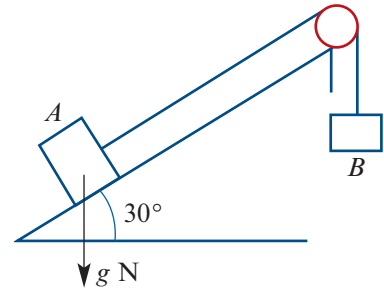

- the magnitude of the acceleration of the particles
 - the tension in the string during this first phase of the motion
 - the magnitude of the velocities of the particles when particle B hits the ground
 - the time taken before the string is taut again, assuming that there is room on the plane for A to continue travelling up the plane.
- 8** An aircraft takes off from the end of a runway in a southerly direction and climbs at an angle of $\tan^{-1}(\frac{1}{2})$ to the horizontal at a speed of $225\sqrt{5}$ km/h.
- Show that, t seconds after take-off, the position vector \mathbf{r} of the aircraft with respect to the end of the runway is given by $\mathbf{r}_1 = \frac{t}{16}(2\mathbf{i} + \mathbf{k})$, where \mathbf{i} , \mathbf{j} and \mathbf{k} are vectors of magnitude 1 km in the directions south, east and vertically upwards respectively.
 - At time $t = 0$, a second aircraft, flying horizontally south-west at $720\sqrt{2}$ km/h, has position vector $-1.2\mathbf{i} + 3.2\mathbf{j} + \mathbf{k}$.
 - Find its position vector \mathbf{r}_2 at time t in terms of \mathbf{i} , \mathbf{j} and \mathbf{k} .
 - Show that there will be a collision and state the time at which it will occur.

- 9** A particle moves in a straight line, starting from point A . Its motion is assumed to be with constant retardation. During the first, second and third seconds of its motion, it covers distances of 70 m, 60 m and 50 m respectively, measured in the same sense.
- Verify that these distances are consistent with the assumption that the particle is moving with constant retardation.
 - Find the retardation and an expression for the displacement of the particle.
 - If the particle comes instantaneously to rest at B , find distance AB .
 - At the same instant that the first particle leaves A , a second particle leaves B with an initial velocity of 75 m/s and travels with constant acceleration towards A . It meets the first particle at a point C , $1\frac{1}{2}$ seconds after leaving B .
 - Find distance BC .
 - Show that the acceleration of the second particle is 60 m/s^2 .
- 10** A particle is fired from the top of a cliff h m above sea level with an initial velocity of V m/s inclined at an angle α above the horizontal. Let \mathbf{i} and \mathbf{j} define the horizontal and vertically upwards vectors in the plane of the particle's path.
- Define:
 - the initial position vector of the particle
 - the particle's initial velocity.
 - The acceleration vector of the particle under gravity is given by $\mathbf{a} = -g\mathbf{j}$. Find:
 - the velocity vector of the particle t seconds after it is projected
 - the corresponding position vector.
 - Use the velocity vector to find the time at which the particle reaches its highest point.
 - Show that the time at which the particle hits the sea is given by

$$t = \frac{V \sin \alpha + \sqrt{(V \sin \alpha)^2 + 2gh}}{g}$$
- 11** A particle travels on a path given by the Cartesian equation $y = x^2 + 2x$.
- Show that one possible vector representing the position of the particle is $\mathbf{r}(t) = (t - 1)\mathbf{i} + (t^2 - 1)\mathbf{j}$.
 - Show that $\mathbf{r}(t) = (e^{-t} - 1)\mathbf{i} + (e^{-2t} - 1)\mathbf{j}$ is also a possible representation of the position of the particle.
 - Two particles travel simultaneously. The positions of the particles are given by $\mathbf{r}_1(t) = (t - 1)\mathbf{i} + (t^2 - 1)\mathbf{j}$ and $\mathbf{r}_2(t) = (e^{-t} - 1)\mathbf{i} + (e^{-2t} - 1)\mathbf{j}$ respectively.
 - Find the initial positions of the two particles.
 - Show that the two particles travel in opposite directions along the path with equation $y = x^2 + 2x$.
 - Find, correct to two decimal places, the coordinates of the point at which the two particles collide.

- 12** A lift that has mass 1000 kg when empty is carrying a man of mass 80 kg. The lift is descending with a downwards acceleration of 1 m/s^2 .
- Calculate the tension in the lift cable.
 - Calculate the vertical force exerted on the man by the floor of the lift.
 - The man drops a coin from a height of 2 m. Calculate the time taken for it to hit the floor of the lift.
 - The lift is designed so that during any journey the magnitude of the acceleration reaches but does not exceed 1 m/s^2 . Safety regulations do not allow the lift cable to bear a tension greater than 20 000 N. Making reasonable assumptions, suggest the number of people that the lift should be licensed to carry. (**Hint:** The maximum tension in the lift cable occurs when the lift is accelerating upwards.)
- 13** Two trains, T_1 and T_2 , are moving on perpendicular tracks that cross at the point O . Relative to O , the position vectors of T_1 and T_2 at time t are given by $\mathbf{r}_1 = Vt\mathbf{i}$ and $\mathbf{r}_2 = 2V(t - t_0)\mathbf{j}$ respectively, where V and t_0 are positive constants.
- Which train goes through O first?
 - How much later does the other train go through O ?
 - Show that the trains are closest together when $t = \frac{4t_0}{5}$.
 - Calculate their distance apart at this time.
 - Draw a diagram to show the positions of the trains at this time. Also show the directions in which they are moving.
- 14** A particle of mass m moves from rest through distance d under a horizontal force F on a rough horizontal plane with coefficient of friction μ . It then collides with another particle of mass $2m$, at rest.
- Find the velocity of the first particle when it hits the second (in terms of F , m , d , μ).
 - The two particles adhere to each other. The combined mass moves a further distance d under friction alone.
 - Find the retardation of the two particles.
 - Find the initial velocity of the two particles.
 - Find F in terms of m and μ .
- 15** A stone is to be projected from ground level over two walls that are a distance of d m apart. Both walls have a height of h m. Let $g \text{ m/s}^2$ be the acceleration due to gravity.
- Find the minimum initial speed of the stone, in terms of d , g and h , such that the stone will go over the two walls.
Hints: First consider the motion from the top of the first wall.
Remember that the horizontal component of the velocity is constant.
 - When the stone is projected over the two walls with the minimum possible initial speed, find the cosine of the angle of projection in terms of d and h .

- 16** A ball is projected against a wall that rebounds the ball in its plane of flight. If the ball has velocity $ai + bj$ just before hitting the wall, its velocity of rebound is given by $-0.8ai + bj$. The ball is projected from ground level, and its position vector before hitting the wall is defined by $r(t) = 10t\mathbf{i} + t(10\sqrt{3} - 4.9t)\mathbf{j}$, $t \geq 0$.
- a** Find:
- the initial position vector of the ball
 - the initial velocity vector of the ball, and hence the magnitude of the velocity and direction (to be stated as an angle of elevation)
 - an expression for the acceleration of the ball.
- b** The wall is at a horizontal distance x from the point of projection. Find in terms of x :
- the time taken by the ball to reach the wall
 - the position vector of the ball at impact
 - the velocity of the ball immediately before impact with the wall
 - the velocity of the ball immediately after impact.
- c** Let the second part of the flight of the ball be defined in terms of t_1 , a time variable, where $t_1 = 0$ at impact. Assuming that the ball is under the same acceleration vector, find in terms of x and t_1 :
- a new velocity vector of the rebound
 - a new position vector of the rebound.
- d** Find the time taken for the ball to hit the ground after the rebound.
- e** Find the value of x (correct to two decimal places) for which the ball will return to its initial position.
- 17** An aeroplane takes off from an airport and, with respect to a given frame of reference, its path with respect to time t is described by the vector $r(t) = (5 - 3t)\mathbf{i} + 2t\mathbf{j} + t\mathbf{k}$, for $t \geq 0$, where $t = 0$ seconds at the time of take-off.
- a** Find the position vector that represents the position of the plane at take-off.
- b** Find:
- the position of the plane at times t_1 and t_2
 - the vector which defines the displacement between these two positions in terms of t_1 and t_2 ($t_2 > t_1$).
- c** Hence show that the plane is travelling along a straight line and state a position vector parallel to the flight.
- d** A road on the ground is defined by the vector $r_1(s) = s\mathbf{i}$, $s \leq 0$.
- Find the magnitude of the acute angle between the path of the plane and the road, correct to two decimal places.
 - Hence, or otherwise, find the shortest distance from the plane to the road 6 seconds after take-off, correct to two decimal places.

- 18** The vector $r_1(t) = (2 - t)\mathbf{i} + (2t + 1)\mathbf{j}$ represents the path of a particle with respect to time t , measured in seconds.
- Find the Cartesian equation that describes the path of the particle. (Assume $t \geq 0$.)
 - Rearrange the above function in the form $r_1(t) = \mathbf{a} + t\mathbf{b}$, where \mathbf{a} and \mathbf{b} are vectors.
 - Describe the vectors \mathbf{a} and \mathbf{b} geometrically with respect to the path of the particle.
 - A second particle which started at the same time as the first particle travels along a path that is represented by $r_2(t) = \mathbf{c} + t(2\mathbf{i} + \mathbf{j})$, $t \geq 0$. The particles collide after 5 seconds.
 - Find \mathbf{c} .
 - Find the distance between the two starting points.

- 19** The paths of two aeroplanes in an aerial display are simultaneously defined by the vectors

$$r_1(t) = (16 - 3t)\mathbf{i} + t\mathbf{j} + (3 + 2t)\mathbf{k}$$

$$r_2(t) = (3 + 2t)\mathbf{i} + (1 + t)\mathbf{j} + (11 - t)\mathbf{k}$$

where t represents the time in minutes. Find:

- the position of the first plane after 1 minute
 - the unit vectors parallel to the flights of each of the two planes
 - the acute angle between their lines of flight, correct to two decimal places
 - the point at which their two paths cross
 - the vector which represents the displacement between the two planes after t seconds
 - the shortest distance between the two planes during their flight.
- 20** A hiker starts from a point defined by the position vector $-7\mathbf{i} + 2\mathbf{j}$ and travels at the rate of 6 km/h along a line parallel to the vector $4\mathbf{i} + 3\mathbf{j}$. The units in the frame of reference are in kilometres.
- Find the vector which represents the displacement of the hiker in 1 hour.
 - Find, in terms of position vectors, the position of the hiker after:
 - 1 hour
 - 2 hours
 - t hours.
 - The path of a cyclist along a straight road is defined simultaneously by the vector equation $\mathbf{b}(t) = (7t - 4)\mathbf{i} + (9t - 1)\mathbf{j}$.
 - Find the position of the hiker when she reaches the road.
 - Find the time taken by the hiker to reach the road.
 - Find, in terms of t , the distance between the hiker and the cyclist t seconds after the start.
 - Find the shortest distance between the hiker and the cyclist, correct to two decimal places.

19

Linear combinations of random variables and distribution of sample means

Objectives

- ▶ To investigate the distribution of a **linear function** of a random variable.
- ▶ To determine the mean and standard deviation of a **linear combination** of two independent random variables.
- ▶ To investigate the behaviour of a linear combination of two normal random variables.
- ▶ To understand the **sample mean** \bar{X} as a random variable.
- ▶ To use simulation to understand the **sampling distribution** of the sample mean \bar{X} .
- ▶ To introduce the **central limit theorem**.
- ▶ To use the central limit theorem to understand the normal approximation to the binomial distribution.
- ▶ To apply the central limit theorem to find **confidence intervals** for the population mean.

Some of the most interesting and useful applications of probability are concerned not with a single random variable, but with combinations of random variables.

For example, the time that it takes to build a house (which is a random variable) is the sum of the times taken for each of the component parts of the build, such as digging the foundations, constructing the frame, installing the plumbing, and so on. Each component is a random variable in its own right, and so has a distribution which can be examined and understood.

In this chapter, we begin our study of more complex scenarios by looking at simple linear combinations of random variables.

Note: The statistics material in Specialist Mathematics Year 12 requires a knowledge of probability and statistics from Mathematical Methods Year 12.

19A Linear combinations of random variables

In this chapter, we are going to extend our knowledge of random variables by considering combinations of random variables and, in particular, the mean and standard deviation of such a combination.

► A linear function of a random variable

In this section, we consider a random variable Y which is a linear function of another random variable X . That is, $Y = aX + b$, where a and b are constants. We can consider b as a location parameter and a as a scale parameter.

Discrete random variables

If X is a discrete random variable, then $Y = aX + b$ is also a discrete random variable. We can determine probabilities associated with Y by using the original probability distribution of X , as illustrated in the following example.

Example 1

The probability distribution of X , the number of cars that Matt sells in a week, is given in the following table.

Number of cars sold, x	0	1	2	3	4
$\Pr(X = x)$	0.45	0.25	0.20	0.08	0.02

Suppose that Matt is paid \$750 each week, plus \$1000 commission on each car sold.

- Express S , Matt's weekly salary, as a linear function of X .
- What is the probability distribution of S ?
- What is the probability that Matt earns more than \$2000 in any given week?

Solution

a $S = 1000X + 750$

b We can use the rule from part **a** to determine the possible values of S .

Weekly salary, s	750	1750	2750	3750	4750
$\Pr(S = s)$	0.45	0.25	0.20	0.08	0.02

c From the table, we have $\Pr(S > 2000) = 0.20 + 0.08 + 0.02 = 0.30$.

Continuous random variables

A continuous random variable X has a probability density function f such that:

- $f(x) \geq 0$ for all x
- $\int_{-\infty}^{\infty} f(x) dx = 1$

Moreover, we have

$$\Pr(X \leq c) = \int_{-\infty}^c f(x) dx$$

If X is a continuous random variable and $a \neq 0$, then $Y = aX + b$ is also a continuous random variable. If $a > 0$, then

$$\Pr(Y \leq y) = \Pr(aX + b \leq y) = \Pr\left(X \leq \frac{y-b}{a}\right)$$

giving

$$\Pr(Y \leq y) = \int_{-\infty}^{\frac{y-b}{a}} f(x) dx$$



Example 2

Assume that the random variable X has density function f given by

$$f(x) = \begin{cases} 1.5(1-x^2) & \text{if } 0 \leq x \leq 1 \\ 0 & \text{if } x > 1 \text{ or } x < 0 \end{cases}$$

a Find $\Pr(X \leq 0.5)$.

b Let $Y = 2X + 3$. Find $\Pr(Y \leq 3.5)$.

Solution

$$\begin{aligned} \mathbf{a} \quad \Pr(X \leq 0.5) &= \int_0^{0.5} f(x) dx \\ &= \int_0^{0.5} 1.5(1-x^2) dx \\ &= 1.5 \left[x - \frac{x^3}{3} \right]_0^{0.5} \\ &= 1.5 \left(0.5 - \frac{0.5^3}{3} \right) \\ &= 0.6875 \end{aligned}$$

$$\begin{aligned} \mathbf{b} \quad \Pr(Y \leq 3.5) &= \int_0^{\frac{3.5-3}{2}} f(x) dx \\ &= \int_0^{0.25} 1.5(1-x^2) dx \\ &= 1.5 \left[x - \frac{x^3}{3} \right]_0^{0.25} \\ &= 1.5 \left(0.25 - \frac{0.25^3}{3} \right) \\ &\approx 0.3672 \end{aligned}$$

► The mean of a linear function of a random variable

Now we consider the mean of Y , where $Y = aX + b$.

Discrete random variables

For a discrete random variable X , by definition we have

$$E(X) = \sum_x x \cdot \Pr(X = x)$$

Thus $E(Y) = E(aX + b)$

$$\begin{aligned} &= \sum_x (ax + b) \cdot \Pr(X = x) \\ &= \sum_x ax \cdot \Pr(X = x) + \sum_x b \cdot \Pr(X = x) \\ &= a \sum_x x \cdot \Pr(X = x) + b \sum_x \Pr(X = x) \\ &= aE(X) + b \end{aligned}$$

$$\text{since } \sum_x \Pr(X = x) = 1$$

Continuous random variables

Similarly, for a continuous random variable X , we have

$$E(X) = \int_{-\infty}^{\infty} x \cdot f(x) dx$$

Thus $E(Y) = E(aX + b)$

$$\begin{aligned} &= \int_{-\infty}^{\infty} (ax + b) \cdot f(x) dx \\ &= \int_{-\infty}^{\infty} ax \cdot f(x) dx + \int_{-\infty}^{\infty} b \cdot f(x) dx \\ &= a \int_{-\infty}^{\infty} x \cdot f(x) dx + b \int_{-\infty}^{\infty} f(x) dx \\ &= aE(X) + b \end{aligned} \quad \text{since } \int_{-\infty}^{\infty} f(x) dx = 1$$

Mean of a linear function of a random variable

If X is a random variable and $Y = aX + b$, where a and b are constants, then

$$E(Y) = E(aX + b) = aE(X) + b$$

► The variance of a linear function of a random variable

What can we say about the variance of Y , where $Y = aX + b$? Whether the random variable X is discrete or continuous, we have

$$\text{Var}(aX + b) = E[(aX + b)^2] - [E(aX + b)]^2$$

$$\begin{aligned} \text{Now } [E(aX + b)]^2 &= [aE(X) + b]^2 \\ &= (a\mu + b)^2 \\ &= a^2\mu^2 + 2ab\mu + b^2 \end{aligned}$$

$$\begin{aligned} \text{and } E[(aX + b)^2] &= E(a^2X^2 + 2abX + b^2) \\ &= a^2E(X^2) + 2ab\mu + b^2 \end{aligned}$$

$$\begin{aligned} \text{Thus } \text{Var}(aX + b) &= a^2E(X^2) + 2ab\mu + b^2 - a^2\mu^2 - 2ab\mu - b^2 \\ &= a^2E(X^2) - a^2\mu^2 \\ &= a^2\text{Var}(X) \end{aligned}$$

Note: This calculation uses sums of random variables, which we discuss later in this section.

Variance of a linear function of a random variable

If X is a random variable and $Y = aX + b$, where a and b are constants, then

$$\text{Var}(Y) = \text{Var}(aX + b) = a^2\text{Var}(X)$$

Although initially the absence of b in the variance may seem surprising, on reflection it makes sense that adding a constant merely changes the location of the distribution, and has no effect on its spread. Similarly, multiplying by a is in effect a scale change, and this is consistent with the result obtained.

Example 3

Suppose that X is a continuous random variable with mean $\mu = 10$ and variance $\sigma^2 = 2$.

a Find $E(2X + 1)$.

b Find $\text{Var}(1 - 3X)$.

Solution

a $E(2X + 1) = 2E(X) + 1$

$$= 2 \times 10 + 1 = 21$$

b $\text{Var}(1 - 3X) = (-3)^2 \text{Var}(X)$

$$= 9 \times 2 = 18$$

► Linear combinations of independent random variables

From Mathematical Methods, you are familiar with the idea of independent events, that is, events A and B such that

$$\Pr(A \cap B) = \Pr(A) \cdot \Pr(B)$$

The term independent can also be applied to random variables. While a formal definition of independent random variables is beyond the scope of this course, we say that two random variables are **independent** if their joint probability function is a product of their individual probability functions.

Consider, for example, the numbers observed when two dice are rolled. Let X_1 be the number observed when the first die is rolled, and X_2 be the number observed when the second die is rolled. The two random variables X_1 and X_2 are independent and have identical distributions.

What can we say about the distribution of $X_1 + X_2$?

Since the rolling of these two dice can be considered as independent events, we can find probabilities associated with the sum by multiplying probabilities associated with each individual random variable. For example:

$$\begin{aligned} \Pr(X_1 + X_2 = 2) &= \Pr(X_1 = 1, X_2 = 1) \\ &= \Pr(X_1 = 1) \cdot \Pr(X_2 = 1) = \frac{1}{6} \times \frac{1}{6} = \frac{1}{36} \end{aligned}$$

Example 4

Suppose that X_1 is the number observed when one die is rolled, and X_2 is the number observed when another die is rolled. Find $\Pr(X_1 + X_2 = 4)$.

Solution

If $X_1 + X_2 = 4$, then the possible outcomes are:

■ $X_1 = 1, X_2 = 3$ ■ $X_1 = 2, X_2 = 2$ ■ $X_1 = 3, X_2 = 1$

Thus $\Pr(X_1 + X_2 = 4)$

$$\begin{aligned} &= \Pr(X_1 = 1, X_2 = 3) + \Pr(X_1 = 2, X_2 = 2) + \Pr(X_1 = 3, X_2 = 1) \\ &= \Pr(X_1 = 1) \cdot \Pr(X_2 = 3) + \Pr(X_1 = 2) \cdot \Pr(X_2 = 2) + \Pr(X_1 = 3) \cdot \Pr(X_2 = 1) \\ &= \left(\frac{1}{6} \times \frac{1}{6}\right) + \left(\frac{1}{6} \times \frac{1}{6}\right) + \left(\frac{1}{6} \times \frac{1}{6}\right) = \frac{1}{12} \end{aligned}$$

The mean and variance of the sum of two random variables

We next consider the mean and variance of the sum of two independent random variables.



Example 5

Suppose again that X_1 is the number observed when one die is rolled, and X_2 is the number observed when another die is rolled. Find:

a $E(X_1 + X_2)$

b $\text{Var}(X_1 + X_2)$

Solution

We can readily determine the probability distribution of $X = X_1 + X_2$.

x	2	3	4	5	6	7	8	9	10	11	12
$\text{Pr}(X = x)$	$\frac{1}{36}$	$\frac{2}{36}$	$\frac{3}{36}$	$\frac{4}{36}$	$\frac{5}{36}$	$\frac{6}{36}$	$\frac{5}{36}$	$\frac{4}{36}$	$\frac{3}{36}$	$\frac{2}{36}$	$\frac{1}{36}$

$$\begin{aligned} \mathbf{a} \quad E(X) &= \sum_x x \cdot \text{Pr}(X = x) \\ &= \frac{2 + 6 + 12 + 20 + 30 + 42 + 40 + 36 + 30 + 22 + 12}{36} \\ &= \frac{252}{36} = 7 \end{aligned}$$

$$\begin{aligned} \mathbf{b} \quad \text{Var}(X) &= E(X^2) - [E(X)]^2 \\ E(X^2) &= \sum_x x^2 \cdot \text{Pr}(X = x) \\ &= \frac{4 + 18 + 48 + 100 + 180 + 294 + 320 + 324 + 300 + 242 + 144}{36} = \frac{1974}{36} \\ \therefore \text{Var}(X) &= \frac{1974}{36} - 49 = \frac{35}{6} \end{aligned}$$

How do these values compare with the mean and variance of X_1 and X_2 ?

We can calculate $E(X_1) = E(X_2) = 3.5$, and we know that $E(X_1 + X_2) = 7$. Thus we have

$$E(X_1 + X_2) = E(X_1) + E(X_2)$$

This result holds for any two random variables X_1 and X_2 .

Similarly, we can calculate $\text{Var}(X_1) = \text{Var}(X_2) = \frac{35}{12}$, and we know that $\text{Var}(X_1 + X_2) = \frac{35}{6}$. Thus we have

$$\text{Var}(X_1 + X_2) = \text{Var}(X_1) + \text{Var}(X_2)$$

This result holds for any two *independent* random variables X_1 and X_2 .

Note: In general, for two independent random variables X_1 and X_2 that are identically distributed, we have $\text{Var}(X_1 + X_2) \neq \text{Var}(2X_1)$, since $\text{Var}(X_1 + X_2) = 2\text{Var}(X_1)$, but $\text{Var}(2X_1) = 2^2\text{Var}(X_1) = 4\text{Var}(X_1)$.

The mean and variance of a linear combination of two random variables

Now consider a linear combination of two random variables X and Y . We have

$$\begin{aligned} E(aX + bY) &= E(aX) + E(bY) \\ &= aE(X) + bE(Y) \quad \text{since } E(aX) = aE(X) \end{aligned}$$

If X and Y are independent, then

$$\begin{aligned} \text{Var}(aX + bY) &= \text{Var}(aX) + \text{Var}(bY) \quad \text{since } X \text{ and } Y \text{ are independent} \\ &= a^2\text{Var}(X) + b^2\text{Var}(Y) \quad \text{since } \text{Var}(aX) = a^2\text{Var}(X) \end{aligned}$$

A linear combination of two random variables

For random variables X and Y and constants a and b :

- $E(aX + bY) = aE(X) + bE(Y)$
- $\text{Var}(aX + bY) = a^2\text{Var}(X) + b^2\text{Var}(Y)$ if X and Y are independent

Example 6

A manufacturing process involves two stages. The time taken to complete the first stage, X hours, is a continuous random variable with mean $\mu = 4$ and standard deviation $\sigma = 1.5$. The time taken to complete the second stage, Y hours, is a continuous random variable with mean $\mu = 7$ and standard deviation $\sigma = 1$. Find the mean and standard deviation of the total processing time, if the times taken at each stage are independent.

Solution

The total processing time is given by $X + Y$. The mean of the total processing time is

$$\begin{aligned} E(X + Y) &= E(X) + E(Y) \\ &= 4 + 7 = 11 \end{aligned}$$

Since X and Y are independent, we have

$$\begin{aligned} \text{Var}(X + Y) &= \text{Var}(X) + \text{Var}(Y) \\ &= (1.5)^2 + (1)^2 = 3.25 \end{aligned}$$

Hence the standard deviation of the total processing time is

$$\text{sd}(X + Y) = \sqrt{3.25} = 1.803$$

The following result will be used in Section 19D, where we consider the distribution of sample means.

A linear combination of n independent random variables

For independent random variables X_1, X_2, \dots, X_n and constants a_1, a_2, \dots, a_n :

- $E(a_1X_1 + a_2X_2 + \dots + a_nX_n) = a_1E(X_1) + a_2E(X_2) + \dots + a_nE(X_n)$
- $\text{Var}(a_1X_1 + a_2X_2 + \dots + a_nX_n) = a_1^2\text{Var}(X_1) + a_2^2\text{Var}(X_2) + \dots + a_n^2\text{Var}(X_n)$

Exercise 19A

Skillsheet

- 1** The number of chocolate bars produced by a manufacturer in any week has the following distribution.

Example 1

x	1000	1500	2000	2500	3000	4000
$\Pr(X = x)$	0.05	0.15	0.35	0.25	0.15	0.05

It costs the manufacturer \$450 per week, plus an additional 50 cents per chocolate bar, to produce the bars.

- a** Express C , the manufacturer's weekly cost of production, as a linear function of X .
b What is the probability distribution of C ?
c What is the probability that the cost is more than \$2000 in any given week?
- 2** Sam plays a game with his sister Annabelle. He tosses a coin three times, and counts the number of times that the coin comes up heads. Annabelle charges him \$5 to play, and gives him \$2.50 for each head that he tosses.
- a** Express W , the net amount he wins, in terms of X , the number of heads observed in the three tosses.
b What is the probability distribution of W ?
c What is the probability that the net amount he wins in a game is more than \$2?

Example 2

- 3** A continuous random variable X has probability density function:

$$f(x) = \begin{cases} 3x^2 & \text{if } 0 \leq x \leq 1 \\ 0 & \text{otherwise} \end{cases}$$

- a** Find $\Pr(X < 0.3)$.
b Let $Y = X + 1$. Find $\Pr(Y \leq 1.5)$.
- 4** A continuous random variable X has probability density function:

$$f(x) = \begin{cases} \frac{\pi}{4} \cos\left(\frac{\pi x}{4}\right) & \text{if } 0 \leq x \leq 2 \\ 0 & \text{otherwise} \end{cases}$$

- a** Find $\Pr(X < 0.5)$.
b Let $Y = 3X - 1$. Find $\Pr(Y > 2)$.
- 5** The probability density function f of a random variable X is given by

$$f(x) = \begin{cases} \frac{x+2}{16} & \text{if } 0 \leq x \leq 4 \\ 0 & \text{otherwise} \end{cases}$$

- a** Find $\Pr(X < 2.5)$.
b Let $Y = 4X + 2$. Find $\Pr(Y > 2)$.

Example 3

- 6 Suppose that X is a random variable with mean $\mu = 25$ and variance $\sigma^2 = 9$.
- Let $Y = 3X + 2$. Find $E(Y)$ and $\text{Var}(Y)$.
 - Let $U = 5 - 2X$. Find $E(U)$ and $\text{sd}(U)$.
 - Let $V = 4 - 0.5X$. Find $E(V)$ and $\text{Var}(V)$.

- 7 A random variable X has density function f given by

$$f(x) = \begin{cases} 0.2 & \text{if } -1 \leq x \leq 0 \\ 0.2 + 1.2x & \text{if } 0 < x \leq 1 \\ 0 & \text{if } x < -1 \text{ or } x > 1 \end{cases}$$

- Find $E(X)$.
- Find $\text{Var}(X)$.
- Hence find $E(4X + 2)$ and $\text{sd}(4X + 2)$.

Example 4

- 8 The independent random variables X and Y have probability distributions as shown.

x	1	2	3
$\text{Pr}(X = x)$	$\frac{1}{2}$	$\frac{1}{3}$	$\frac{1}{6}$

y	2	4
$\text{Pr}(Y = y)$	$\frac{1}{3}$	$\frac{2}{3}$

Let $S = X + Y$.

- Complete a table to show the probability distribution of S .
 - Find $E(S)$
 - Find $\text{Pr}(S \leq 5)$.
- 9 Suppose that X_1 is the number observed when one fair die is rolled, and X_2 is the number observed when another fair die is rolled.
- Find $\text{Pr}(X_1 - X_2 = 0)$.
 - Find $\text{Pr}(X_1 + 3X_2 = 6)$.
- 10 Pippi is going on a school family picnic. Family groups will sit together on tables in the park. The number of children in a family, X , follows the distribution shown.

x	1	2	3	4
$\text{Pr}(X = x)$	0.5	0.3	0.15	0.05

The number of children in a family is independent of the number of children in any other family. Find the probability that, if two families sit at the one table, there will be more than three children in the combined group.

Example 5

- 11 Suppose that X_1 is the number observed when a five-sided die is rolled, and X_2 is the number observed when another five-sided die is rolled. Find from first principles:

- $E(X_1)$
- $\text{Var}(X_1)$
- $E(X_1 - X_2)$
- $\text{Var}(X_1 - X_2)$

- 12 The random variables X_1 and X_2 are independent and identically distributed, with means $\mu_{X_1} = \mu_{X_2} = 18$ and variances $\sigma_{X_1}^2 = \sigma_{X_2}^2 = 4$. Find:

- $E(2X_1 + 3)$
- $\text{Var}(2X_1 + 3)$
- $E(X_1 + X_2)$
- $\text{Var}(2X_1)$
- $\text{Var}(X_1 + X_2)$

- Example 6** **13** To get to school, Jasmine rides her bike to the station and then catches the train. The time taken for her to ride to the station and catch the train, X minutes, is a continuous random variable with mean $\mu = 17$ and standard deviation $\sigma = 4.9$. The time taken for the train journey, Y minutes, is a continuous random variable with mean $\mu = 32$ and standard deviation $\sigma = 7$. Find the mean and standard deviation of the total time taken for her to get to school, if the times taken for each part of the journey are independent.
- 14** A coffee machine automatically dispenses coffee into a cup, followed by hot milk. The volume of coffee dispensed has a mean of 50 mL and a standard deviation of 5 mL. The volume of hot milk dispensed has a mean of 145 mL and a standard deviation of 10 mL. What are the mean and standard deviation of the total amount of fluid dispensed by the machine?
- 15** Mikki buys three bags of bananas and two bags of apples from the greengrocer. If bags of bananas have a mean weight of 750 g, with a variance of 25, and bags of apples have a mean weight of 1000 g, with a variance of 50, what are the mean and standard deviation of the total weight of her purchases?



19B Linear combinations of independent normal random variables

In the previous section, we looked at the mean and variance of a linear combination of two independent random variables. However, we were not able to say much about the form of the distribution or to calculate probabilities, except in very simple examples. In this section, we investigate the special case when both of the random variables are normally distributed.

It can be proved theoretically, but is beyond the scope of this course, that a sum of independent normal random variables is also normally distributed.

A linear combination of two independent normal random variables

Let X and Y be independent normal random variables and let a and b be constants. Then $aX + bY$ is also normally distributed and, since X and Y are independent:

$$\blacksquare E(aX + bY) = aE(X) + bE(Y) \qquad \blacksquare \text{Var}(aX + bY) = a^2\text{Var}(X) + b^2\text{Var}(Y)$$

Example 7

The time taken to prepare a house for painting is known to be normally distributed with a mean of 10 hours and a standard deviation of 4 hours. The time taken to paint the house is independent of the preparation time, and is normally distributed with a mean of 20 hours and a standard deviation of 3 hours. What is the probability that the total time taken to prepare and paint the house is more than 35 hours?

Solution

Let X represent the time taken to prepare the house, and Y the time taken to paint the house. Since X and Y are independent normal random variables, the distribution of $X + Y$ is also normal, with

$$E(X + Y) = E(X) + E(Y) = 10 + 20 = 30$$

$$\text{Var}(X + Y) = \text{Var}(X) + \text{Var}(Y) = 4^2 + 3^2 = 25$$

$$\text{sd}(X + Y) = \sqrt{25} = 5$$

Therefore

$$\Pr(X + Y > 35) = \Pr\left(Z > \frac{35 - 30}{5}\right) = \Pr(Z > 1) = 0.1587$$

Exercise 19B**Skillsheet****Example 7**

- 1 A restaurant knows that time taken to prepare a meal is normally distributed, with a mean of 12 minutes and a standard deviation of 6 minutes. The time taken to cook the meal is independent of the preparation time, and is normally distributed with a mean of 14 minutes and a standard deviation of 8 minutes. What is the probability that a diner will have to wait more than 30 minutes for their meal to be served?
- 2 Batteries of type A have a mean voltage of 5.0 volts, with variance 0.0225. Type B batteries have a mean voltage of 8.0 volts, with variance 0.04. If we form a series connection containing one battery of each type, what is the probability that the combined voltage exceeds 13.4 volts?
- 3 Scores on the mathematics component of a standardised test are normally distributed with a mean of 63 and a standard deviation of 10. Scores on the English component of the test are normally distributed with a mean of 68 and a standard deviation of 7. Assuming that the two components of the test are independent of each other, find the probability that a student's mathematics score is higher than their English score.
- 4 The clearance between two components of a device is important, as component A must fit inside component B. The outer diameter of component A is normally distributed with mean $\mu_A = 0.425$ cm and variance $\sigma_A^2 = 0.0001$, and the inner diameter of component B is normally distributed with mean $\mu_B = 0.428$ cm and variance $\sigma_B^2 = 0.0004$. What is the probability that component A will not fit inside component B?
- 5 Two students are known to have equal ability in playing an electronic game, so that each of their scores are normally distributed with mean 25 000 and standard deviation 3000. The two scores are independent. What is the probability that, in a particular game, the students' scores will differ by more than 7500 points?

- 6 Suppose that the weights of people are normally distributed with a mean of 82 kg and a standard deviation of 9 kg. What is the maximum number of people who can get into an elevator which has a weight limit of 680 kg, if we want to be at least 99% sure that the elevator does not exceed capacity?
- 7 An alarm system has 20 batteries that are connected so that, when one battery fails, the next one takes over. (Only one battery is working at any one time.) The batteries operate independently, and each has a mean life of 7 hours and a standard deviation of 0.5 hours. What is the probability that the alarm system is still working after 145 hours?
- 8 Certain machine components have lifetimes, in hours, which are independent and normally distributed with mean 300 and variance 100. Find the probability that:
- the total life of three components is more than 950 hours
 - the total life of four components is more than 1250 hours.
- 9 The independent random variables X and Y each have a normal distribution. The means of X and Y are 10 and 12 respectively, and the standard deviations are 3 and 4 respectively. Find $\Pr(X < Y)$.



19C Simulating the distribution of sample means

Random sampling is studied in Mathematical Methods Year 12. In this section, we use simulation to investigate sample means.

► Summary of concepts

- A **population** is the set of all eligible members of a group which we intend to study. A population does not have to be a group of people. For example, it could consist of all apples produced in a particular area, or all components produced by a factory.
- A **sample** is a subset of the population which we select in order to make inferences about the population. Generalising from the sample to the population will not be useful unless the sample is representative of the population.
- The simplest way to obtain a valid sample is to choose a **random sample**, where every member of the population has an equal chance of being included in the sample.
- The **population mean** μ is the mean of all values of a measure in the entire population; the **sample mean** \bar{x} is the mean of these values in a particular sample.
- The population mean μ is a **population parameter**; its value is constant for a given population. The sample mean \bar{x} is a **sample statistic**; its value is not constant, but varies from sample to sample.
- The sample mean \bar{X} can be viewed as a random variable, and its distribution is called a **sampling distribution**. The variation in the sampling distribution decreases as the size of the sample increases.

When the population mean μ is not known, we can use the sample mean \bar{x} as an estimate of this parameter. The larger the sample size, the more confident we can be that the sample statistic gives a good estimate of the population parameter.

► An example

Suppose that one million people live in a particular city and we know that the mean IQ for this population is 100 and the standard deviation is 15. This example illustrates the ideas listed in the summary:

- **Population** The population is the one million people living in the particular city.
- **Sample** We will take a random sample of 10 people from the population.
- **Population mean μ** We are considering IQ and the population mean μ is 100.
- **Sample mean \bar{x}** The sample mean \bar{x} is obtained by determining the mean IQ of the 10 people in the sample.
- **Random variable \bar{X}** If we take a number of samples of size 10 from the same population and determine the mean IQ for each of these samples, we obtain a ‘distribution’ of sample means. The means of these samples are the values of the random variable \bar{X} .

To investigate the random variable IQ, we use the **normal distribution**, which is introduced in Mathematical Methods.

This histogram shows the distribution of the IQ scores of 1000 people randomly drawn from the population. You can see that the distribution is symmetric and bell-shaped, with its centre of symmetry at the population mean.

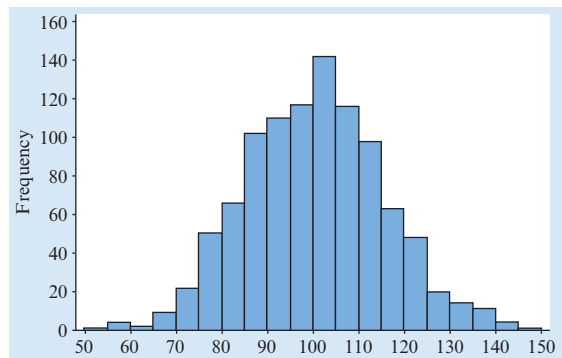

► The sample mean as a random variable

We can use a calculator to simulate drawing a random sample of size 10 from this population.

Using the TI-Nspire

To generate a random sample of size 10 from a normal population with mean 100 and standard deviation 15:

- Start from a **Lists & Spreadsheet** page.
- Name the list ‘iq’ in Column A.
- In the formula cell of Column A, enter the formula using (Menu) > **Data** > **Random** > **Normal** and complete as:
= randnorm(100, 15, 10)

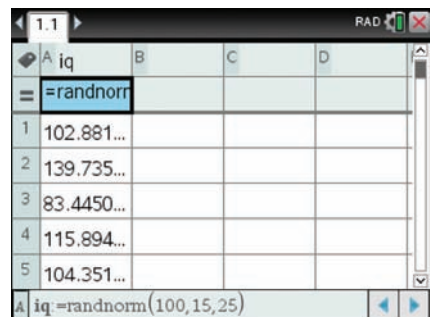

Note: The syntax is: randnorm(*mean, standard deviation, sample size*)

Using the Casio ClassPad

To generate a random sample of size 10 from a normal population with mean 100 and standard deviation 15:

- In \sqrt{x} , press the **Keyboard** button.
- Find and then select **Catalog** by first tapping \blacktriangledown at the bottom of the left sidebar.
- Scroll across the alphabet to the letter R.
- Select **randNorm**(and type: 15, 100, 10)
- Tap \blacktriangleright to view all the values.

Notes:

- The syntax is: $\text{randNorm}(\text{standard deviation}, \text{mean}, \text{sample size})$
- Alternatively, the random sample can be generated in the **Statistics** application.

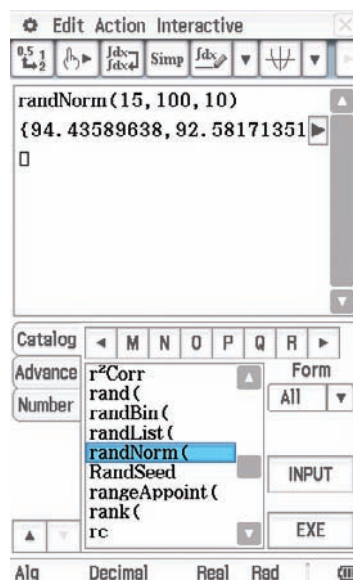

One random sample of 10 scores, obtained by simulation, is

105, 109, 104, 86, 118, 100, 81, 94, 70, 88

Recall that the sample mean is denoted by \bar{x} and that

$$\bar{x} = \frac{\sum x}{n}$$

where \sum means 'sum' and n is the size of the sample.

Here the sample mean is

$$\bar{x} = \frac{105 + 109 + 104 + 86 + 118 + 100 + 81 + 94 + 70 + 88}{10} = 95.5$$

A second sample, also obtained by simulation, is

114, 124, 128, 133, 95, 107, 117, 91, 115, 104

with sample mean

$$\bar{x} = \frac{114 + 124 + 128 + 133 + 95 + 107 + 117 + 91 + 115 + 104}{10} = 112.8$$

Since \bar{x} varies according to the contents of the random samples, we can consider the sample means \bar{x} as being the values of a random variable, which we denote by \bar{X} .

Since \bar{x} is a statistic which is calculated from a sample, the probability distribution of the random variable \bar{X} is called a **sampling distribution**.

► The sampling distribution of the sample mean

Generating random samples and then calculating the mean from the sample is quite a tedious process if we wish to investigate the sampling distribution of \bar{X} empirically. Luckily, we can also use technology to simulate values of the sample mean.

Using the TI-Nspire

To generate the sample means for 10 random samples of size 25 from a normal population with mean 100 and standard deviation 15:

- Start from a **Lists & Spreadsheet** page.
- Name the list 'iq' in Column A.
- In cell A1, enter the formula using **Menu** > **Data** > **Random** > **Normal** and complete as as:
= mean(randnorm(100, 15, 25))
- Fill down to obtain the sample means for 10 random samples.

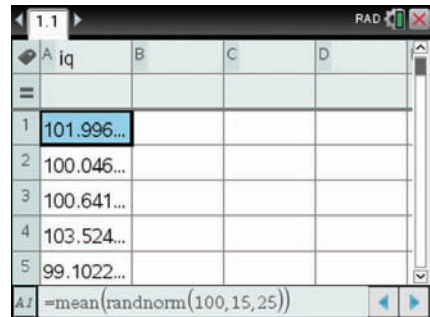

For a large number of simulations, an alternative method is easier.

To generate the sample means for 500 random samples of size 25, enter the following formula in the formula cell of Column A:

$$= \text{seq}(\text{mean}(\text{randnorm}(100, 15, 25)), k, 1, 500)$$

The dotplot on the right was created this way.

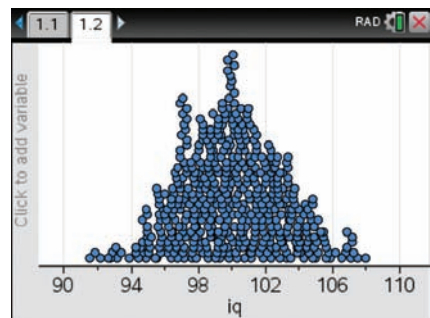

Using the Casio ClassPad

To generate the sample means for 10 random samples of size 25 from a normal population with mean 100 and standard deviation 15:

- Open the **Spreadsheet** application .
- Tap in cell A1.
- Type: = mean(randNorm(15, 100, 25))
- Go to **Edit** > **Fill** > **Fill Range**.
- Type A1:A10 for the range and tap **OK**.

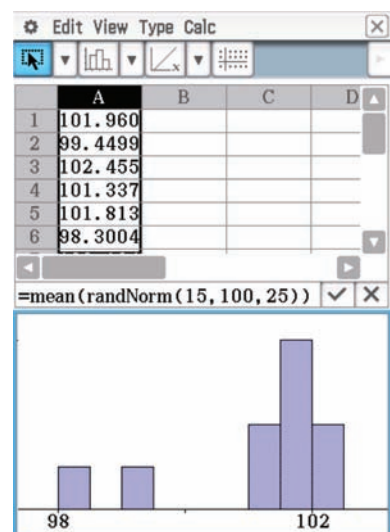

To sketch a histogram of these sample means:

- Go to **Edit** > **Select** > **Select Range**.
- Type A1:A10 for the range and tap **OK**.
- Select **Graph** and tap **Histogram**.

Suppose that 10 random samples (each of size 25) are selected from a population with mean 100 and standard deviation 15. The values of \bar{x} obtained might look like those in the following dotplot. The values look to be centred around 100, ranging from 97.3 to 109.2.

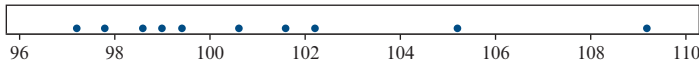

To better investigate the distribution requires more sample means. The following dotplot summarises the values of \bar{x} observed for 100 samples (each of size 25).

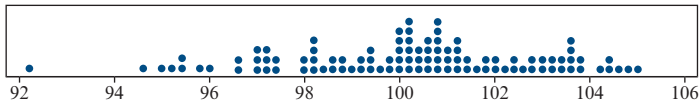

This histogram shows the distribution of the sample mean when 1000 samples (each of size 25) were selected from a population with mean 100 and standard deviation 15.

We see from this plot that the distribution of sample means is symmetric and bell-shaped, suggesting that the sampling distribution of the sample mean may also be described by the normal distribution.

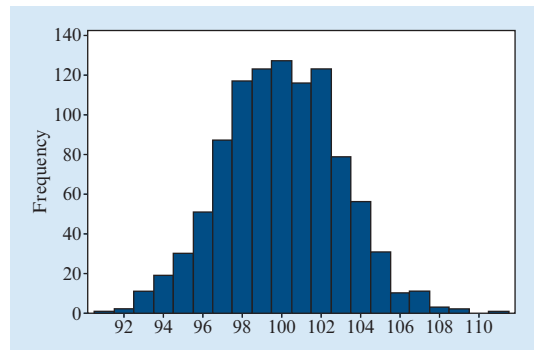

► The effect of sample size on the distribution of the sample mean

We can also use simulation to explore how the distribution of the sample mean is affected by the size of the sample chosen. The following dotplots show the sample means \bar{x} obtained when 200 samples of size 25, then size 100 and then size 200 were chosen from a population.

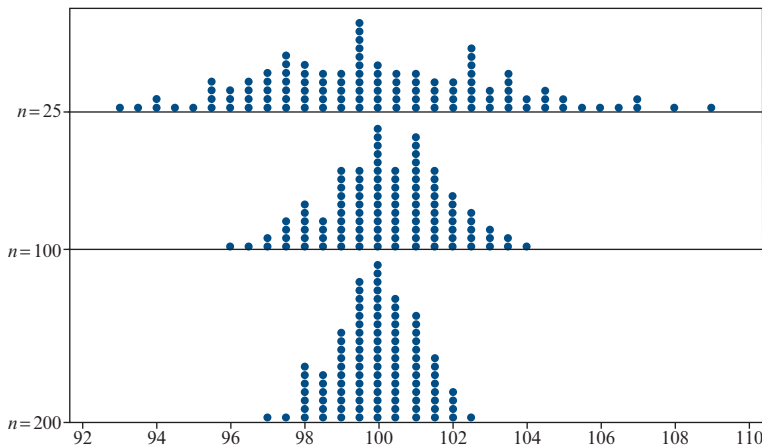

Each symbol represents up to 2 observations.

We can see from the dotplots that all three sampling distributions appear to be centred at 100, the value of the population mean μ . Furthermore, as the sample size increases, the values of the sample mean \bar{x} are more tightly clustered around that value.

These observations are confirmed in following table, which gives the mean and standard deviation for each of the three simulated sampling distributions shown in the dotplots.

Sample size	25	100	200
Population mean μ	100	100	100
Mean of the values of \bar{x}	99.24	100.24	100.03
Standard deviation of the values of \bar{x}	3.05	1.59	1.06



Example 8

The sizes of kindergarten classes in a certain city are normally distributed, with a mean size of $\mu = 24$ children and a standard deviation of $\sigma = 2$.

- Use your calculator to generate the sample means for 100 samples, each of size 20. Find the mean and standard deviation of these values of the sample mean.
- Use your calculator to generate the sample means for 100 samples, each of size 50. Find the mean and standard deviation of these values of the sample mean.
- Compare the values of the mean and standard deviation calculated in **a** and **b**.

Solution

a

class	B	C	D
1	23.5256...		
2	23.6930...		
3	23.8367...		
4	23.2532...		
5	24.6111...		

ATL =mean(randnorm(24,2,20))

A	B	C
1	23.7470	
2	24.7521	
3	22.8099	
4	24.1111	
5	23.5842	
6	23.9909	

=mean(randNorm(2,24,20))

stat.results	
"Title"	"One-Variable Statistics"
" \bar{x} "	23.95054864
" Σx "	2395.054864
" Σx^2 "	57385.35997
" $s_x := s_{n-1}x$ "	0.4765400989
" $\sigma_x := \sigma_n x$ "	0.4741514116
"n"	100
"MinX"	22.75618384
" $Q_1 X$ "	23.59974451

One-Variable	
\bar{x}	= 24.026172
Σx	= 2402.6172
Σx^2	= 57750.667
σ_x	= 0.4997201
s_x	= 0.5022376
n	= 100

b

"Title"	"One-Variable Statistics"
" \bar{x} "	23.96779378
" Σx "	2396.779378
" Σx^2 "	57453.24128
" $s_x := s_{n-1}x$ "	0.2793828807
" $\sigma_x := \sigma_n x$ "	0.2779824564
"n"	100
"MinX"	23.25513595
"Q1X"	23.75454397

"One-Variable"
$\bar{x} = 23.973018$
$\Sigma x = 2397.3018$
$\Sigma x^2 = 57479.552$
$\sigma_x = 0.2999175$
$s_x = 0.3014285$
$n = 100$

- c The means determined from the simulations are very similar, and close to the population mean of 24, as expected. The standard deviation for the samples of size 50 is much smaller than the standard deviation for the samples of size 20.

Exercise 19C

Example 8

- The lengths of a species of fish are normally distributed with mean length $\mu = 40$ cm and standard deviation $\sigma = 4$ cm.
 - Use your calculator to simulate 100 values of the sample mean calculated from a sample of size 50 drawn from this population of fish.
 - Summarise the values obtained in part a in a dotplot.
 - Find the mean and standard deviation of these values of the sample mean.
- The marks in a statistics examination in a certain university are normally distributed with a mean of $\mu = 48$ marks and a standard deviation of $\sigma = 15$ marks.
 - Use your calculator to simulate 100 values of the sample mean calculated from a sample of size 20 drawn from the students at this university.
 - Summarise the values obtained in part a in a dotplot.
 - Find the mean and standard deviation of these values of the sample mean.



19D The distribution of the sample mean of a normally distributed random variable

In Section 19B, we saw that the sum of two independent normal random variables is also normal. This fact can be extended to more than two random variables, and is particularly useful when considering the distribution of the sample mean.

We start by looking at the very simple case of a sample of size 2, before we consider the general case of a sample of size n .

► A sample of size 2

Suppose that IQ in a certain population is a normally distributed random variable, X , with mean $\mu = 100$ and standard deviation $\sigma = 15$.

Let X_1 represent the IQ of a person selected at random from this population. Then X_1 is normally distributed with mean $\mu = 100$ and standard deviation $\sigma = 15$.

Let X_2 represent the IQ of another person selected at random from this population. Then X_2 is also normally distributed with mean $\mu = 100$ and standard deviation $\sigma = 15$.

As long as both X_1 and X_2 are randomly selected, they are independent random variables.

Now consider the mean IQ of the two people:

$$\bar{X} = \frac{X_1 + X_2}{2}$$

We can recognise this expression as a linear combination of X_1 and X_2 , that is, as a linear combination of two independent normal random variables. Therefore we know that \bar{X} is also normally distributed, with

$$\begin{aligned} E(\bar{X}) &= E\left(\frac{X_1 + X_2}{2}\right) & \text{and} & & \text{Var}(\bar{X}) &= \text{Var}\left(\frac{X_1 + X_2}{2}\right) \\ &= \frac{1}{2}E(X_1 + X_2) & & & &= \frac{1}{4}\text{Var}(X_1 + X_2) \\ &= \frac{1}{2}(\mu + \mu) & & & &= \frac{1}{4}(\text{Var}(X_1) + \text{Var}(X_2)) \\ &= \mu & & & &= \frac{1}{4}(\sigma^2 + \sigma^2) = \frac{\sigma^2}{2} \\ &= 100 & & & & \end{aligned}$$

Thus the standard deviation is $\text{sd}(\bar{X}) = \sqrt{\frac{\sigma^2}{2}} = \frac{\sigma}{\sqrt{2}} = \frac{15}{\sqrt{2}}$.

Samples of size 2 from a normal distribution

Let X be a normal random variable, with mean μ and standard deviation σ , which represents a particular measure on a population (for example, IQ scores or rope lengths).

Samples of size 2 from the population can be described by two independent random variables, X_1 and X_2 , which have identical distributions to X .

The **sample mean** is defined to be

$$\bar{X} = \frac{X_1 + X_2}{2}$$

- The sample mean \bar{X} is normally distributed with mean μ and standard deviation $\frac{\sigma}{\sqrt{2}}$.
- A particular value of \bar{X} is denoted by \bar{x} and is obtained from a particular sample.

We can write $\bar{x} = \frac{x_1 + x_2}{2}$.

Example 9

Suppose that IQ in a certain population is a normally distributed random variable, X , with mean $\mu = 100$ and standard deviation $\sigma = 15$.

- Find the probability that a randomly selected individual has an IQ greater than 115.
- Find the probability that the mean IQ of two randomly selected individuals is greater than 115.
- Compare the answers to parts **a** and **b**.

Solution

a $\Pr(X > 115) = \Pr\left(Z > \frac{115 - 100}{15}\right) = \Pr(Z > 1) = 0.1587$

- b** Since \bar{X} is normally distributed with mean $\mu_{\bar{X}} = 100$ and standard deviation $\sigma_{\bar{X}} = \frac{15}{\sqrt{2}}$, we have

$$\Pr(\bar{X} > 115) = \Pr\left(Z > \frac{115 - 100}{\frac{15}{\sqrt{2}}}\right) = \Pr(Z > 1.414) = 0.0787$$

- c** The probability that the mean IQ of a sample of size 2 will be greater than 115 is much smaller than the probability that an individual will have an IQ greater than 115.

► A sample of size n

Of course, when we calculate a sample mean, we are generally working with a much larger sample size than 2. We now consider a sample of size n , where X is a normal random variable. Again, the sample mean \bar{X} can be considered to be a linear combination of independent normal random variables, and \bar{X} is itself a normal random variable.

Samples of size n from a normal distribution

Let X be a normal random variable, with mean μ and standard deviation σ , which represents a particular measure on a population (for example, IQ scores or rope lengths).

Samples of size n from the population can be described by n independent random variables, X_1, X_2, \dots, X_n , which have identical distributions to X .

The **sample mean** is defined to be

$$\bar{X} = \frac{X_1 + X_2 + \dots + X_n}{n}$$

- The sample mean \bar{X} is normally distributed with mean μ and standard deviation $\frac{\sigma}{\sqrt{n}}$.
- A particular value of \bar{X} is denoted by \bar{x} and is obtained from a particular sample.

We can write $\bar{x} = \frac{x_1 + x_2 + \dots + x_n}{n}$.

Note: The value \bar{x} is called a **point estimate** of the population mean μ .

The formulas for the mean and standard deviation of \bar{X} are obtained using analogous calculations to those for size 2.

The mean of the sample mean \bar{X} is found as follows:

$$\begin{aligned} E(\bar{X}) &= E\left(\frac{X_1 + X_2 + \cdots + X_n}{n}\right) \\ &= \frac{1}{n}(E(X_1) + E(X_2) + \cdots + E(X_n)) \quad \text{since } E(aX + bY) = aE(X) + bE(Y) \\ &= \frac{1}{n} \times n\mu \\ &= \mu \end{aligned}$$

Similarly, we can find the variance of the sample mean \bar{X} :

$$\begin{aligned} \text{Var}(\bar{X}) &= \text{Var}\left(\frac{X_1 + X_2 + \cdots + X_n}{n}\right) \\ &= \frac{1}{n^2} \text{Var}(X_1 + X_2 + \cdots + X_n) \quad \text{as } \text{Var}(aX) = a^2 \text{Var}(X) \\ &= \frac{1}{n^2} (\text{Var}(X_1) + \text{Var}(X_2) + \cdots + \text{Var}(X_n)) \quad \text{as } \text{Var}(X + Y) = \text{Var}(X) + \text{Var}(Y) \\ &\quad \text{for } X \text{ and } Y \text{ independent} \\ &= \frac{1}{n^2} \times n\sigma^2 \\ &= \frac{\sigma^2}{n} \end{aligned}$$

For example, when the sample mean \bar{X} is calculated from a random sample of size 25 from a normally distributed population with mean $\mu = 100$ and standard deviation $\sigma = 15$:

$$\begin{aligned} E(\bar{X}) &= \mu = 100 \\ \text{Var}(\bar{X}) &= \frac{\sigma^2}{n} = \frac{225}{25} = 9 \\ \text{sd}(\bar{X}) &= \sqrt{9} = 3 \end{aligned}$$

We can summarise our results as follows.

Distribution of the sample mean

If X is a normally distributed random variable with mean μ and standard deviation σ , then the distribution of the sample mean \bar{X} will also be normal, with mean $E(\bar{X}) = \mu$ and standard deviation $\text{sd}(\bar{X}) = \frac{\sigma}{\sqrt{n}}$, where n is the sample size.

If we know that a random variable has a normal distribution and know its mean and standard deviation, then we know exactly the sampling distribution of the sample mean and can thus make predictions about its behaviour.

Example 10

Experience has shown that the heights of a certain population of women can be assumed to be normally distributed with mean $\mu = 160$ cm and standard deviation $\sigma = 8$ cm. What can be said about the distribution of the sample mean for a sample of size 16?

Solution

Let X be the height of a woman chosen at random from this population.

The distribution of the sample mean \bar{X} is normal with mean $\mu_{\bar{X}} = \mu = 160$ and standard deviation $\sigma_{\bar{X}} = \frac{\sigma}{\sqrt{n}} = \frac{8}{\sqrt{16}} = 2$.

Example 11

Consider the population described in Example 10. What is the probability that:

- a** a woman chosen at random has a height greater than 168 cm
- b** a sample of four women chosen at random has an average height greater than 168 cm?

Solution

$$\mathbf{a} \quad \Pr(X > 168) = \Pr\left(Z > \frac{168 - 160}{8}\right) = \Pr(Z > 1) = 0.1587$$

$$\mathbf{b} \quad \text{The distribution of the sample mean } \bar{X} \text{ is normal with mean } \mu_{\bar{X}} = \mu = 160 \text{ and standard deviation } \sigma_{\bar{X}} = \frac{\sigma}{\sqrt{n}} = \frac{8}{\sqrt{4}} = 4.$$

$$\text{Thus } \Pr(\bar{X} > 168) = \Pr\left(Z > \frac{168 - 160}{4}\right) = \Pr(Z > 2) = 0.0228$$

Exercise 19D**Skillsheet**

- 1** The distribution of final marks in a statistics course is normal with a mean of 70 and a standard deviation of 6.

Example 9

- a** Find the probability that a randomly selected student has a final mark above 80.
- b** Find the probability that the mean final mark for two randomly selected students is above 80.
- c** Compare the answers to parts **a** and **b**.

Example 10

- 2** The distribution of final marks in an examination is normal with a mean of 74 and a standard deviation of 8. A random sample of three students is selected and their mean mark calculated. What are the mean and standard deviation of this sample mean?
- 3** A machine produces nails which have an intended diameter of $\mu = 25.025$ mm, with a standard deviation of $\sigma = 0.003$ mm. A sample of five nails is selected for inspection each hour and their average diameter calculated. What are the mean and standard deviation of this average diameter?

Example 11

- 4 Suppose that IQ in a certain population is a normally distributed random variable, X , with mean $\mu = 100$ and standard deviation $\sigma = 15$.
- Find the probability that a randomly selected individual has an IQ greater than 120.
 - Find the probability that the mean IQ of three randomly selected individuals is greater than 120.
 - Compare the answers to parts **a** and **b**.
- 5 At the Fizzy Drinks Company, the volume of soft drink in a 1 litre bottle is normally distributed with mean $\mu = 1$ litre and standard deviation $\sigma = 0.01$ litres.
- Use your calculator to simulate 100 values of the sample mean calculated from a sample of 25 bottles from this company. Determine the mean and standard deviation of these values of the sample mean.
 - Determine the theoretical mean and standard deviation of the sample mean, and compare them with your answers from part **a**.
- 6 Gestation time for pregnancies without problems in humans is approximately normally distributed, with a mean of $\mu = 266$ days and a standard deviation of $\sigma = 16$ days. In the maternity ward of a large hospital, a random sample of seven women who had just given birth after pregnancies without problems was selected. What is the probability that the average gestation period for these seven pregnancies exceeded 280 days?
- 7 Yearly income for those in the 18–25 age group living in a certain state is normally distributed with mean $\mu = \$32\,500$ and standard deviation $\sigma = \$6000$. What is the probability that 10 randomly chosen individuals in this age group have an average income of less than \$28 000?
- 8 The IQ scores of adults are known to be normally distributed with mean $\mu = 100$ and standard deviation $\sigma = 15$. Find the probability that a randomly chosen group of 25 adults will have an average IQ of more than 105.
- 9 The actual weight of sugar in a 1 kg package produced by a food-processing company is normally distributed with mean $\mu = 1.00$ kg and standard deviation $\sigma = 0.03$ kg. What is the probability that the average weight for a randomly chosen sample of 20 packages is less than 0.98 kg?
- 10 The tar content of a certain brand of cigarettes is known to be normally distributed with mean $\mu = 10$ mg and standard deviation $\sigma = 0.5$ mg. A random sample of 50 cigarettes is chosen and the average tar content determined. Find the probability that this average is more than 10.1 mg.
- 11 The time for a customer to be served at a fast-food outlet is normally distributed with a mean of 3.5 minutes and a standard deviation of 1.0 minutes. What is the probability that 20 customers can be served in less than one hour?



19E The central limit theorem

The sampling distribution of the sample mean \bar{X} is normal if the distribution of X is normal. What can we say if X is not normally distributed? Using simulation, we can investigate empirically the sampling distribution of the sample mean calculated from a variety of different distributions.

► An example of the distribution of sample means

Consider, for example, a random variable X with the probability density function

$$f(x) = \begin{cases} 0.5 & \text{if } 2 \leq x \leq 4 \\ 0 & \text{if } x < 2 \text{ or } x > 4 \end{cases}$$

The graph of this probability density function (shown on the right) is clearly not normal.

It can be readily verified that X has mean $\mu = 3$ and standard deviation $\sigma = \frac{1}{\sqrt{3}}$.

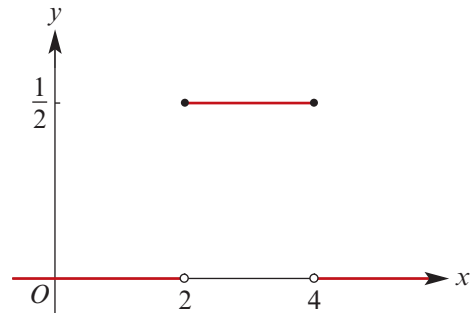

Suppose that we select a sample of size 100 from this distribution. The data arising from simulating one such sample are summarised in the histogram on the right.

From the theoretical probability distribution, we would expect the sample values to be reasonably evenly distributed between 2 and 4. That is, we might expect all of the columns in the histogram to be about the same height.

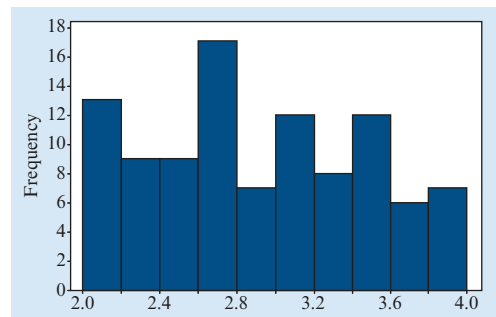

The actual histogram of the data shows a reasonable amount of variation in the individual values. The mean of the sample shown, \bar{x} , is 2.9 and the sample standard deviation, s , is 0.56.

Consider now what the histogram might look like if each value represented was not an individual data value, but the mean of five data values.

To investigate the distribution of the sample mean, we select 100 samples, each of size 5. The distribution of sample means \bar{x} is shown in the histogram on the right.

We can see that now the histogram does not show values evenly spread across the whole range. Instead, even with quite small samples, the sample means are clustering around the population mean $\mu = 3$.

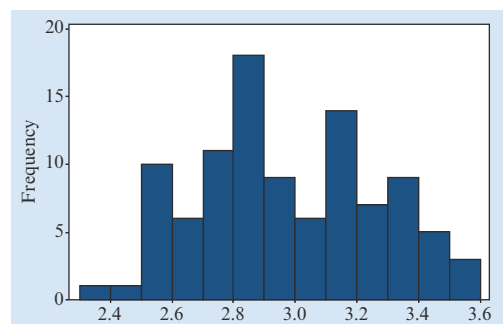

What would be the effect of increasing the sample size from 5 to 100? To investigate this, we now select 100 samples, each of size 100. We can see from this histogram that these sample means are distributed quite symmetrically around the population mean $\mu = 3$ and that the sampling distribution can be quite well described as approximately normal.

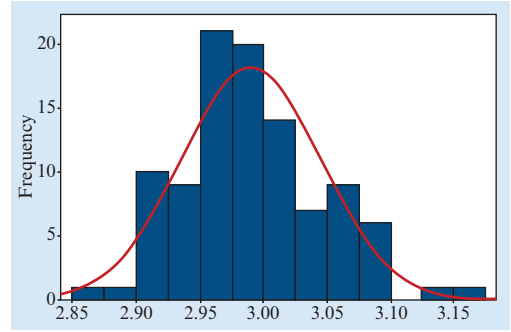

So, while the distribution of X is clearly not normal, the sampling distribution of \bar{X} is quite well approximated by a normal distribution. The following plots show how the sampling distribution of the sample mean becomes increasingly normal and less variable as the sample size increases.

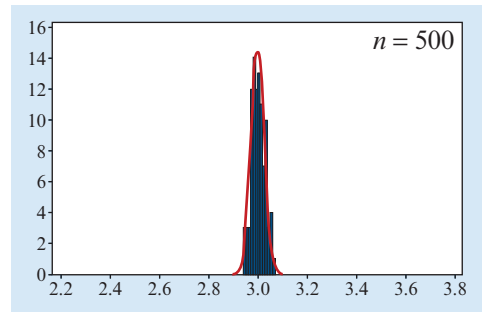
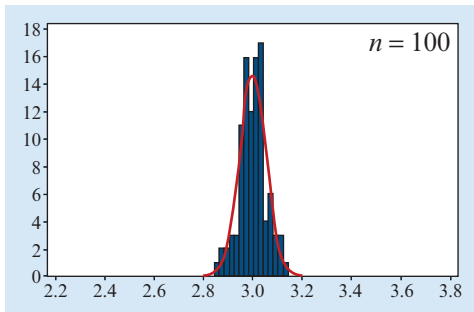
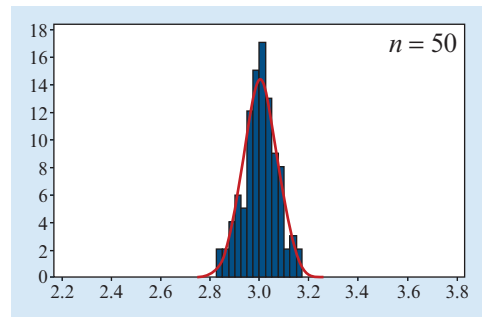
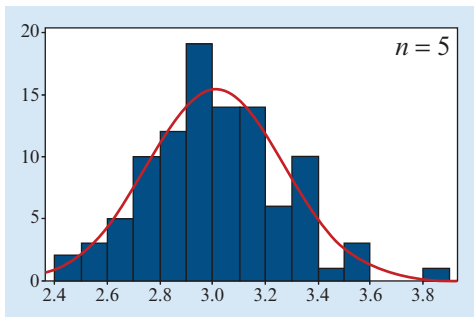

► **Another example of the distribution of sample means**

Let us consider another random variable X , with probability density function given by

$$f(x) = \begin{cases} \frac{1}{2}e^{-\frac{x}{2}} & \text{if } x \geq 0 \\ 0 & \text{if } x < 0 \end{cases}$$

Thus X is the exponential random variable with parameter $\lambda = \frac{1}{2}$, and so we know that X has mean $\mu = 2$ and standard deviation $\sigma = 2$.

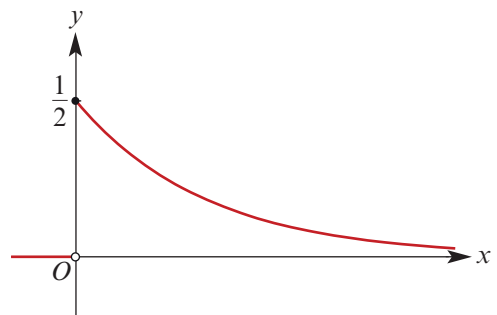

Suppose that we select a sample of 100 individual observations from this distribution. The data from one such sample are summarised in the following histogram. The distribution is quite similar to the theoretical distribution, as we would expect. The mean of the sample shown, \bar{x} , is 1.9 and the sample standard deviation, s , is 1.7.

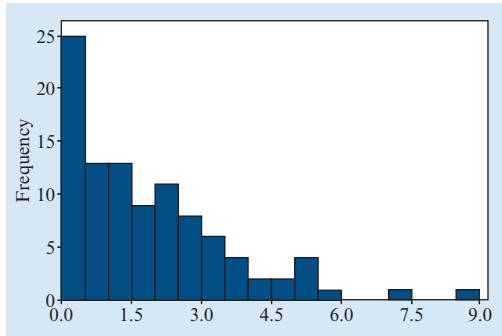

We now investigate the distribution of the sample mean by selecting 100 samples of size 5, then size 50, then size 100 and then size 500. The distributions of sample means \bar{x} obtained are shown in the following histograms.

We see that the sampling distribution of the sample mean becomes increasingly normal and less variable as the sample size increases. Since the distribution is quite skewed to start with, a larger sample size is required before the sampling distribution of the sample mean begins to look normal.

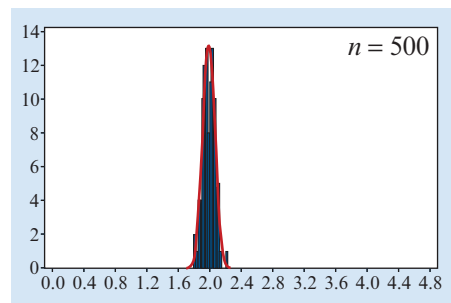
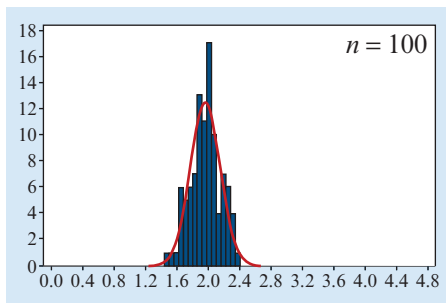
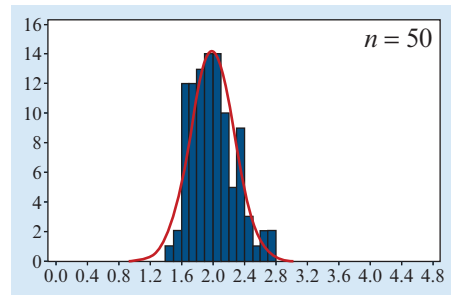
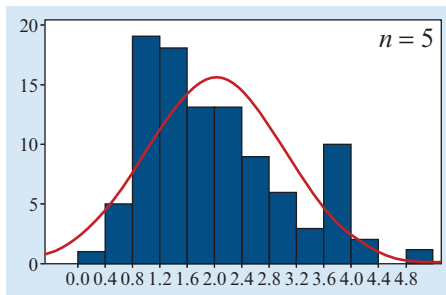

Again, the distribution of X is clearly not normal, but the sampling distribution of \bar{X} is quite well approximated by a normal distribution when the sample size is large enough.

► The central limit theorem

From these two examples we have found that, for different underlying distributions, the sampling distribution of the sample mean is approximately normal, provided the sample size n is large enough. Furthermore, the approximation to the normal distribution improves as the sample size increases. This fact is known as the **central limit theorem**.

Central limit theorem

Let X be any random variable, with mean μ and standard deviation σ . Then, provided that the sample size n is large enough, the distribution of the sample mean \bar{X} is approximately normal with mean $E(\bar{X}) = \mu$ and standard deviation $\text{sd}(\bar{X}) = \frac{\sigma}{\sqrt{n}}$.

Note: For most distributions, a sample size of 30 is sufficient.

The central limit theorem may be used to solve problems associated with sample means, as illustrated in the following example.



Example 12

The amount of coffee, X mL, dispensed by a machine has a distribution with probability density function f defined by

$$f(x) = \begin{cases} \frac{1}{20} & \text{if } 160 \leq x \leq 180 \\ 0 & \text{otherwise} \end{cases}$$

Find the probability that the average amount of coffee contained in 25 randomly chosen cups will be more than 173 mL.

Solution

The central limit theorem tells us that the distribution of the sample mean is approximately normal. To find the mean and standard deviation of the distribution, we first find the mean and standard deviation of X :

$$E(X) = \int_{160}^{180} \frac{x}{20} dx = \left[\frac{x^2}{40} \right]_{160}^{180} = 170$$

$$\text{and } E(X^2) = \int_{160}^{180} \frac{x^2}{20} dx = \left[\frac{x^3}{60} \right]_{160}^{180} = 28\,933.33$$

$$\text{So } \text{sd}(X) = \sqrt{28\,933.33 - 170^2} = 5.77$$

By the central limit theorem, the sample mean \bar{X} is (approximately) normally distributed with

$$E(\bar{X}) = E(X) = 170 \quad \text{and} \quad \text{sd}(\bar{X}) = \frac{\text{sd}(X)}{\sqrt{n}} = \frac{5.77}{5} = 1.15$$

Therefore

$$\Pr(\bar{X} > 173) = \Pr\left(Z > \frac{173 - 170}{1.15}\right) = \Pr(Z > 2.61) = 1 - 0.9955 = 0.0045$$

► The normal approximation to the binomial distribution

The fact that the binomial distribution can be well approximated by the normal distribution was discussed in Mathematical Methods Year 12.

If X is a binomial random variable with parameters n and p , then the distribution of X is approximately normal, with mean $\mu = np$ and standard deviation $\sigma = \sqrt{np(1-p)}$, provided $np > 5$ and $n(1-p) > 5$.

This approximation can now be justified using the central limit theorem.

We know that a binomial random variable, X , is the number of successes in n independent trials, each with probability of success p . We can express X as the sum of n independent random variables Y_1, Y_2, \dots, Y_n , called **Bernoulli random variables**.

Each Y_i takes values 0 and 1, with $\Pr(Y_i = 1) = p$ and $\Pr(Y_i = 0) = 1 - p$, where the value 1 corresponds to success and the value 0 corresponds to failure. We can write

$$X = Y_1 + Y_2 + \dots + Y_n$$

and therefore

$$\frac{X}{n} = \frac{Y_1 + Y_2 + \dots + Y_n}{n} = \bar{Y}$$

By the central limit theorem, the sample mean \bar{Y} has an approximately normal distribution, for large n . Since $X = n\bar{Y}$, we see that X also has an approximately normal distribution.

Note: For a binomial random variable X , we can consider the sample mean $\frac{X}{n}$, with

$$\begin{aligned} E\left(\frac{X}{n}\right) &= \frac{E(X)}{n} = \frac{np}{n} = p \\ \text{Var}\left(\frac{X}{n}\right) &= \frac{\text{Var}(X)}{n^2} = \frac{np(1-p)}{n^2} = \frac{p(1-p)}{n} \end{aligned}$$

This random variable is denoted by \hat{P} in Mathematical Methods Year 12.

Example 13

The population in a particular state is known to be 50% female. What is the probability that a random sample of 100 people will contain less than 45% females?

Solution

Let X denote the number of females in the sample. Then X has a binomial distribution with $n = 100$ and $p = 0.5$.

By the central limit theorem, the distribution of the sample mean $\frac{X}{n}$ is approximately normal, with

$$E\left(\frac{X}{n}\right) = p = 0.5 \quad \text{and} \quad \text{Var}\left(\frac{X}{n}\right) = \frac{p(1-p)}{n} = \frac{0.5 \times 0.5}{100} = 0.0025$$

Thus

$$\Pr\left(\frac{X}{n} < 0.45\right) = \Pr\left(Z < \frac{0.45 - 0.5}{0.05}\right) = \Pr(Z < -1) = 0.1587$$

Exercise 19E

Skillsheet

Example 12

- 1** The lengths of blocks of cheese, X cm, produced by a machine have a distribution with probability density function

$$f(x) = \begin{cases} 5 & \text{if } 10.0 \leq x \leq 10.2 \\ 0 & \text{otherwise} \end{cases}$$

- a** Find the probability that a randomly selected block is more than 10.1 cm long.
- b** Find the probability that the average length of 30 randomly selected blocks is more than 10.12 cm.
- 2** The mean number of accidents per week at an intersection is 3.2 and the standard deviation is 1.6. The distribution is discrete, and so is not normal. What is the probability that the average number of accidents per week at the intersection over a year is less than 2.5?
- 3** The working life of a particular brand of electric light bulb has a mean of 1200 hours and a standard deviation of 200 hours. What is the probability that the mean life of a sample of 64 bulbs is less than 1150 hours?
- 4** The amount of pollutant emitted from a smokestack in a day, X kg, has probability density function f defined by

$$f(x) = \begin{cases} \frac{4}{9}x(5 - x^2) & \text{if } 0 \leq x \leq 1 \\ 0 & \text{if } x > 1 \text{ or } x < 0 \end{cases}$$

- a** Find the probability that the amount of pollutant emitted on any one day is more than 0.5 kg.
- b** Find the probability that the average amount of pollutant emitted on a random sample of 30 days is more than 0.5 kg.
- 5** The incubation period for a certain disease is between 5 and 11 days after contact. The probability of showing the first symptoms at various times during the incubation period is described by the probability density function

$$f(x) = \begin{cases} \frac{1}{36}(t - 5)(11 - t) & \text{if } 5 \leq x \leq 11 \\ 0 & \text{otherwise} \end{cases}$$

Find the probability that the average time for the appearance of symptoms for a random sample of 40 people with the disease was less than 7.5 days.

Example 13

- 6** The manager of a car-hire company knows from experience that 55% of their customers prefer automatic cars. If there are 50 automatic cars available on a particular day, use the normal approximation to the binomial distribution to estimate the probability that the company will not be able to meet the demand of the next 100 customers.

- 7 If 15% of people are left-handed, use the normal approximation to the binomial distribution to find the probability that at least 200 people in a randomly selected group of 1000 people are left-handed.
- 8 The thickness of silicon wafers is normally distributed with mean 1 mm and standard deviation 0.1 mm. A wafer is acceptable if it has a thickness between 0.85 and 1.1.
- a What is the probability that a wafer is acceptable?
- b If 200 wafers are selected, estimate the probability that between 140 and 160 wafers are acceptable.



19F Confidence intervals for the population mean

The most important application of the central limit theorem is that it allows us to determine confidence intervals for a population mean, even if the population is not normally distributed.

In practice, the reason we analyse samples is to further our understanding of the population from which they are drawn. That is, we know what is in the sample, and from that knowledge we would like to infer something about the population.

► Point estimates

Suppose, for example, we are interested in the mean IQ score of all Year 12 mathematics students in Australia. The value of the population mean μ is unknown. Collecting information about the whole population is not feasible, and so a random sample must suffice.

What information can be obtained from a single sample? Certainly, the sample mean \bar{x} gives some indication of the value of the population mean μ , and can be used when we have no other information.

The value of the sample mean \bar{x} can be used to estimate the population mean μ . Since this is a single-valued estimate, it is called a **point estimate** of μ .

Thus, if we select a random sample of 100 Year 12 mathematics students and find that their mean IQ is 108.6, then the value $\bar{x} = 108.6$ serves as an estimate of the population mean μ .

► Interval estimates

The value of the sample mean \bar{x} obtained from a single sample is going to change from sample to sample, and while sometimes the value will be close to the population mean μ , at other times it will not. To use a single value to estimate μ can be rather risky. What is required is an interval that we are reasonably sure contains the parameter value μ .

An **interval estimate** for the population mean μ is called a **confidence interval** for μ .

► Calculating confidence intervals

We have seen in the previous section that, whatever the underlying distribution of the random variable X , if the sample size n is large, then the sampling distribution of \bar{X} is approximately normal with

$$E(\bar{X}) = \mu \quad \text{and} \quad \text{sd}(\bar{X}) = \frac{\sigma}{\sqrt{n}}$$

By standardising, we can say that the distribution of the random variable

$$\frac{\bar{X} - \mu}{\frac{\sigma}{\sqrt{n}}}$$

is approximated by that of the standard normal random variable Z .

For the standard normal random variable Z , we have

$$\Pr(-1.96 < Z < 1.96) = 0.95$$

So we can state that, for large n :

$$\Pr\left(-1.96 < \frac{\bar{X} - \mu}{\frac{\sigma}{\sqrt{n}}} < 1.96\right) \approx 0.95$$

Multiplying through gives

$$\Pr\left(-1.96 \frac{\sigma}{\sqrt{n}} < \bar{X} - \mu < 1.96 \frac{\sigma}{\sqrt{n}}\right) \approx 0.95$$

Further simplifying, we obtain

$$\Pr\left(\bar{X} - 1.96 \frac{\sigma}{\sqrt{n}} < \mu < \bar{X} + 1.96 \frac{\sigma}{\sqrt{n}}\right) \approx 0.95$$

This final expression gives us an interval which, with 95% probability, will contain the value of the population mean μ (which we do not know).

An approximate **95% confidence interval** for μ is given by

$$\left(\bar{x} - 1.96 \frac{\sigma}{\sqrt{n}}, \bar{x} + 1.96 \frac{\sigma}{\sqrt{n}}\right)$$

where:

- μ is the population mean (unknown)
- \bar{x} is a value of the sample mean
- σ is the value of the population standard deviation
- n is the size of the sample from which \bar{x} was calculated.

Note: Often when determining a confidence interval for the population mean, the population standard deviation σ is unknown. If the sample size is large (say $n \geq 30$), then we can use the sample standard deviation s in this formula as an approximation to the population standard deviation σ .

Example 14

Find an approximate 95% confidence interval for the mean IQ of Year 12 mathematics students in Australia, if we select a random sample of 100 students and find the sample mean \bar{x} to be 108.6. Assume that the standard deviation for this population is 15.

Solution

The interval is found by substituting $\bar{x} = 108.6$, $n = 100$ and $\sigma = 15$ into the expression for an approximate 95% confidence interval:

$$\left(\bar{x} - 1.96 \frac{\sigma}{\sqrt{n}}, \bar{x} + 1.96 \frac{\sigma}{\sqrt{n}} \right) = \left(108.6 - 1.96 \times \frac{15}{\sqrt{100}}, 108.6 + 1.96 \times \frac{15}{\sqrt{100}} \right) \\ = (105.66, 111.54)$$

Thus, based on a sample of size 100 and a sample estimate of 108.6, an approximate 95% confidence interval for the population mean μ is (105.66, 111.54).

Using the TI-Nspire

- In a **Calculator** page, use **(Menu) > Statistics > Confidence Intervals > z Interval**.
- If necessary, change the **Data Input Method** to **Stats**.
- Enter the given values and the confidence level as shown.
- The 'CLower' and 'CUpper' values give the 95% confidence interval (105.66, 111.54).

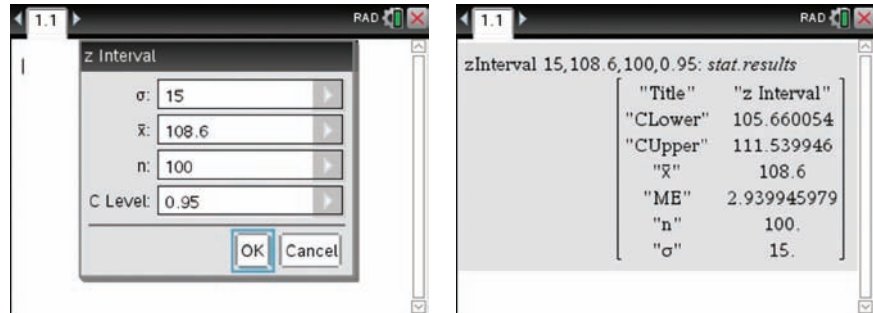

Note: 'ME' stands for margin of error, which is covered later in this section.

Using the Casio ClassPad

- In **Statistics**, go to **Calc > Interval**. Select **One-Sample Z Int** and **Variable**. Tap **Next**.
- Enter the confidence level and the given values as shown below. Tap **Next**.
- The 'Lower' and 'Upper' values give the 95% confidence interval (105.66, 111.54).

Type	Interval	C-Level	0.95	Lower	105.66005
	One-Sample Z Int	σ	15	Upper	111.53995
	<input type="radio"/> List <input checked="" type="radio"/> Variable	\bar{x}	108.6	\bar{x}	108.6
		n	100	n	100

► Interpretation of confidence intervals

The confidence interval found in Example 14 should not be interpreted as meaning that $\Pr(105.66 < \mu < 111.54) = 0.95$. Since μ is a constant, the value either does or does not lie in the stated interval.

The particular confidence interval found is just one of any number of confidence intervals which could be found for the population mean μ , each one depending on the particular value of the sample mean \bar{x} .

The correct interpretation of the confidence interval is that we expect approximately 95% of such intervals to contain the population mean μ . Whether or not the particular confidence interval obtained contains the population mean μ is generally not known.

If we were to repeat the process of taking a sample and calculating a confidence interval many times, the result would be something like that indicated in the diagram.

The diagram shows the confidence intervals obtained when 20 different samples were drawn from the same population. The round dot indicates the value of the sample estimate in each case. The intervals vary, because the samples themselves vary. The value of the population mean μ is indicated by the vertical line.

It is quite easy to see from the diagram that none of the values of the sample estimate is exactly the same as the population mean, but that all the intervals except one (19 out of 20, or 95%) have captured the value of the population mean, as would be expected in the case of a 95% confidence interval.

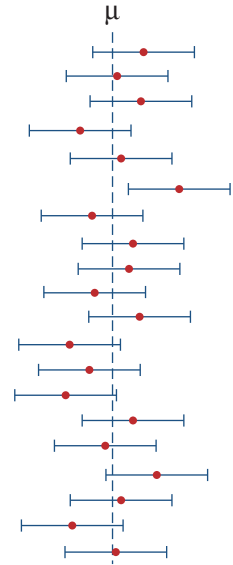

► Precision and margin of error

In Example 14, we found an approximate 95% confidence interval (105.66, 111.54) for the mean IQ of Year 12 mathematics students, based on a sample of size 100.



Example 15

Find an approximate 95% confidence interval for the mean IQ of Year 12 mathematics students in Australia, if we select a random sample of 400 students and find the sample mean \bar{x} to be 108.6. Assume that the standard deviation for this population is 15.

Solution

The interval is found by substituting $\bar{x} = 108.6$, $n = 400$ and $\sigma = 15$ into the expression for an approximate 95% confidence interval:

$$\begin{aligned} \left(\bar{x} - 1.96 \frac{\sigma}{\sqrt{n}}, \bar{x} + 1.96 \frac{\sigma}{\sqrt{n}} \right) &= \left(108.6 - 1.96 \times \frac{15}{\sqrt{400}}, 108.6 + 1.96 \times \frac{15}{\sqrt{400}} \right) \\ &= (107.13, 110.07) \end{aligned}$$

Thus, based on a sample of size 400, a 95% confidence interval is (107.13, 110.07), which is narrower than the interval determined in Example 14.

In Example 15, by increasing the sample size, we obtained a narrower 95% confidence interval and therefore a more precise estimate for the population mean μ .

The **margin of error** of a confidence interval is the distance between the sample estimate and the endpoints of the interval.

For a 95% confidence interval for μ , the margin of error is given by

$$M = 1.96 \times \frac{\sigma}{\sqrt{n}}$$

We can use this expression to find the appropriate sample size n to use in order to ensure a specified margin of error M .

A 95% confidence interval for a population mean μ will have margin of error equal to a specified value of M when the sample size is

$$n = \left(\frac{1.96\sigma}{M} \right)^2$$

Example 16

Consider again the problem of estimating the average IQ of Year 12 mathematics students in Australia. What size sample is required to ensure a margin of error of 1.5 points or less at the 95% confidence level? (Assume that $\sigma = 15$.)

Solution

Substituting $M = 1.5$ and $\sigma = 15$ gives

$$n = \left(\frac{1.96 \times 15}{1.5} \right)^2 = 384.16$$

Thus a minimum sample of 385 students is needed to achieve a margin of error of at most 1.5 points in a 95% confidence interval for the population mean.

► Changing the level of confidence

So far we have only considered 95% confidence intervals, but in fact we can choose any level of confidence for a confidence interval. What is the effect of changing the level of confidence?

Consider again a 95% confidence interval:

$$\left(\bar{x} - 1.96 \frac{\sigma}{\sqrt{n}}, \bar{x} + 1.96 \frac{\sigma}{\sqrt{n}} \right)$$

From our knowledge of the normal distribution, we can say that a 99% confidence interval will be given by

$$\left(\bar{x} - 2.58 \frac{\sigma}{\sqrt{n}}, \bar{x} + 2.58 \frac{\sigma}{\sqrt{n}} \right)$$

In general, a $C\%$ confidence interval is given by

$$\left(\bar{x} - k \frac{\sigma}{\sqrt{n}}, \bar{x} + k \frac{\sigma}{\sqrt{n}} \right)$$

where k is such that

$$\Pr(-k < Z < k) = \frac{C}{100}$$

Example 17

Calculate and compare 90%, 95% and 99% confidence intervals for the mean IQ of Year 12 mathematics students in Australia, if we select a random sample of 100 students and find the sample mean \bar{x} to be 108.6. (Assume that $\sigma = 15$.)

Solution

From Example 14, we know that the 95% confidence interval is (105.66, 111.54).

The 90% confidence interval is

$$\left(108.6 - \frac{1.65 \times 15}{10}, 108.6 + \frac{1.65 \times 15}{10} \right) = (106.13, 111.07)$$

The 99% confidence interval is

$$\left(108.6 - \frac{2.58 \times 15}{10}, 108.6 + \frac{2.58 \times 15}{10} \right) = (104.74, 112.46)$$

As we can see, increasing the level of confidence results in a wider confidence interval.

Exercise 19F

Skillsheet

Example 14

- 1 A university lecturer selects a sample of 40 of her first-year students to determine how many hours per week they spend on study outside class time. She finds that their average study time is 7.4 hours. If the standard deviation of study time, σ , is known to be 1.8 hours, find a 95% confidence interval for the mean study time for the population of first-year students.

- 2 The lengths of time (in seconds) for which each of a randomly selected sample of 12-year-old girls could hold their breath are as follows.

14 43 16 25 25 35 14 42 23 33 20 60
39 68 18 20 25 30 20 32 54 35 45 48

If breath-holding time is known to be normally distributed, with a standard deviation of 15 seconds, find a 95% confidence interval for the mean time for which a 12-year-old girl can hold her breath.

- 3 A random sample of 49 of a certain brand of batteries was found to last an average of 14.6 hours. If the standard deviation of battery life is known to be 20 minutes, find a 95% confidence interval for the mean time that the batteries will last.

Example 15

- 4** A quality-control engineer in a factory needs to estimate the mean weight, μ grams, of bags of potato chips that are packed by a machine. The engineer knows by experience that $\sigma = 2.0$ grams for this machine.
- The engineer takes a random sample of 36 bags and finds the sample mean to be 25.4 grams. Find a 95% confidence interval for μ .
 - Now suppose the mean of 25.4 grams was calculated from a sample of 100 bags. Find a 95% confidence interval for μ .
 - Compare your confidence intervals in parts **a** and **b**.
- 5** In an investigation of physical fitness of students, resting heart rates were recorded for a sample of 15 female students. The sample had a mean of 71.1 beats per minute. The investigator knows from experience that resting heart rates are normally distributed and have a standard deviation of 6.4 beats per minute. Find a 95% confidence interval for the mean resting heart rate of the relevant population of female students.
- 6** Fifty plots are planted with a new variety of corn. The average yield for these plots is 130 bushels per acre. Assuming that the standard deviation is equal to 10, find a 95% confidence interval for the mean yield, μ , of this variety of corn.
- 7** The average amount of time (in hours per week) spent in physical exercise by a random sample of 24 male Year 12 students is as follows.

4.0 3.3 4.5 0.0 8.0 2.0 3.3 2.5 7.0 2.0 12.0 4.0
8.0 3.0 6.0 2.5 1.0 0.5 5.0 6.0 4.0 1.0 0.0 7.0

Assuming that time spent in physical exercise by Year 12 males is normally distributed with a standard deviation of 3 hours, find an approximate 95% confidence interval for the mean time spent in physical exercise for the relevant population of Year 12 students.

- 8** A random sample of 100 males were asked to give the age at which they married. The average age given by these men was 29.5 years, and the standard deviation was 10 years. Use this information to find a 95% confidence interval for the mean age of marriage for males.
- 9** The following is a list of scores on a manual-dexterity test for children with a particular learning disability.

20 30 19 21 33 20 21 17 25 25 32
26 31 22 23 26 26 23 25 17 27 21
23 27 24 28 21 33 22 23 17 26 24

Assuming these measurements to be a random sample from a normally distributed population with standard deviation 4, construct an approximate 95% confidence interval for the mean score on this test for children with this learning disability.

- 10** Twenty-two air samples taken at the same place over a period of six months showed the following amounts of suspended matter (in micrograms per cubic metre of air).

68 22 36 32 42 24 28 38 39 26 21
79 45 57 59 34 43 57 30 31 28 30

Assuming these measurements to be a random sample from a normally distributed population with standard deviation 10, construct an approximate 95% confidence interval for the mean amount of suspended matter during that time period.

- 11** The birth weights, in kilograms, of a random sample of 30 full-term babies with no complications born at a hospital are as follows.

2.9 2.7 3.5 3.6 2.8 3.6 3.7 3.6 3.6 2.9
3.7 3.6 3.2 2.9 3.2 2.5 2.6 3.8 3.0 4.2
2.8 3.5 3.3 3.1 3.0 4.2 3.2 2.4 4.3 3.2

Find an approximate 95% confidence interval for the mean weight of full-term babies with no complications, if the birth weights of full-term babies are normally distributed with a standard deviation of 400 g.

Example 16

- 12** For a population with a standard deviation of 100, how large a random sample is needed in order to be 95% confident that the sample mean is within 20 of the population mean?
- 13** A quality-control engineer in a factory needs to estimate the mean weight, μ grams, of bags of potato chips that are packed by a machine. The engineer knows by experience that $\sigma = 2.0$ grams for this machine. What size sample is required to ensure that we can be 95% confident that the estimate will be within 0.5 g of μ ?
- 14** The number of customers per day at a fast-food outlet is known to have a standard deviation of 50. What size sample is required so that the owner can be 95% confident that the difference between the sample mean and the true mean is not more than 10?
- 15** A manufacturer knows that the standard deviation of the lifetimes of their light bulbs is 150 hours. What size sample is required so that the manufacturer can be 95% confident that the sample mean, \bar{x} , will be within 20 hours of the population mean?
- 16** Consider once again the problem of estimating the average IQ score, μ , of Year 12 mathematics students. (Assume that $\sigma = 15$.)
- What size sample is required to ensure with 95% confidence that the estimated mean IQ will be within 2 points of μ ?
 - What size sample is required to ensure with 95% confidence that the estimated mean IQ will be within 1 point of μ ?
 - In general, what is the effect on the sample size of halving the margin of error?

- Example 17** **17** Calculate and compare 90%, 95% and 99% confidence intervals for the mean battery life for a certain brand of batteries, if the mean life of 25 batteries was found to be 35.7 hours. (Assume that $\sigma = 15$.)
- 18** It is known that IQ scores in the general population are normally distributed with mean $\mu = 100$ and standard deviation $\sigma = 15$.
- Use your calculator to generate 10 values of the sample mean \bar{x} for random samples of size 20 drawn from this population.
 - Use your calculator to find a 90% confidence interval for the population mean μ from each of these values of the sample mean \bar{x} .
 - How many of these intervals contain the value of the population mean μ ?
 - How many of these intervals would you expect to contain the value of the population mean μ ?
 - What is the probability that they will all contain the value of the population mean?
- 19** Suppose that marks on a mathematics test are normally distributed with mean $\mu = 30$ and standard deviation $\sigma = 7$.
- Use your calculator to generate 10 values of the sample mean \bar{x} for random samples of size 30 drawn from this population.
 - Use your calculator to find an 80% confidence interval for the population mean μ from each of these values of the sample mean \bar{x} .
 - How many of these intervals contain the value of the population mean μ ?
 - How many of these intervals would you expect to contain the value of the population mean μ ?
 - What is the probability that they will all contain the value of the population mean?
- 20** In a new complex of rooms, 100 new light bulbs were installed. The mean length of time that the light bulbs lasted was $\bar{x} = 120$ hours, with a standard deviation of $s = 75$ hours. Calculate an approximate 95% confidence interval for the mean lifetime of this type of light bulb.
- 21** Resting pulse rates were measured for a group of 90 randomly chosen 7-year-old children from a city, giving a sample mean of $\bar{x} = 82.6$ beats per minute and a standard deviation of $s = 10.3$ beats per minute. Calculate an approximate 90% confidence interval for the mean resting pulse rate of all 7-year-old children in the city.
- 22** An investigation was conducted into the total distance travelled by cars currently in use in a city. A random sample of 500 cars were stopped and the distances they had travelled were recorded. The sample mean was 46 724 km and the sample standard deviation was 15 172 km. Calculate an approximate 98% confidence interval for the average distance travelled by cars in this city.



Chapter summary



Linear combinations of random variables

- If $Y = aX + b$ is a linear function of a random variable X , where a and b are constants with $a > 0$, then $\Pr(Y \leq y) = \Pr\left(X \leq \frac{y-b}{a}\right)$.
- For a random variable X and constants a and b :
 - $E(aX + b) = aE(X) + b$
 - $\text{Var}(aX + b) = a^2\text{Var}(X)$
- For random variables X and Y and constants a and b :
 - $E(aX + bY) = aE(X) + bE(Y)$
 - $\text{Var}(aX + bY) = a^2\text{Var}(X) + b^2\text{Var}(Y)$ if X and Y are independent
- Let X and Y be independent normal random variables and let a and b be constants. Then $aX + bY$ is also a normal random variable.

Distribution of sample means

- The **population mean** μ is the mean of all values of a measure in a population. The **sample mean** \bar{x} is the mean of these values in a particular sample.
- The sample mean \bar{X} can be viewed as a random variable, and its distribution is called a **sampling distribution**.
- If X is a normally distributed random variable with mean μ and standard deviation σ , then the distribution of the sample mean \bar{X} will also be normal, with mean $E(\bar{X}) = \mu$ and standard deviation $\text{sd}(\bar{X}) = \frac{\sigma}{\sqrt{n}}$, where n is the sample size.
- **Central limit theorem**
Let X be any random variable, with mean μ and standard deviation σ . Then, provided that the sample size n is large enough, the distribution of the sample mean \bar{X} is approximately normal with mean $E(\bar{X}) = \mu$ and standard deviation $\text{sd}(\bar{X}) = \frac{\sigma}{\sqrt{n}}$.
- If X is a binomial random variable with parameters n and p , then the distribution of X is approximately normal, with mean $\mu = np$ and standard deviation $\sigma = \sqrt{np(1-p)}$, provided $np > 5$ and $n(1-p) > 5$.
- The value of the sample mean \bar{x} can be used to estimate the population mean μ . Since this is a single-valued estimate, it is called a **point estimate** of μ .
- An **interval estimate** for the population mean μ is called a **confidence interval** for μ .
- An approximate **95% confidence interval** for the population mean μ is given by

$$\left(\bar{x} - 1.96 \frac{\sigma}{\sqrt{n}}, \bar{x} + 1.96 \frac{\sigma}{\sqrt{n}}\right)$$

where:

- μ is the population mean (unknown)
- \bar{x} is a value of the sample mean
- σ is the value of the population standard deviation
- n is the size of the sample from which \bar{x} was calculated.

- The **margin of error** of a confidence interval is the distance between the sample estimate and the endpoints of the interval. For a 95% confidence interval for μ , the margin of error is given by

$$M = 1.96 \times \frac{\sigma}{\sqrt{n}}$$

- A 95% confidence interval for a population mean μ will have margin of error equal to a specified value of M when the sample size is

$$n = \left(\frac{1.96\sigma}{M} \right)^2$$

- In general, a $C\%$ confidence interval is given by

$$\left(\bar{x} - k \frac{\sigma}{\sqrt{n}}, \bar{x} + k \frac{\sigma}{\sqrt{n}} \right)$$

where k is such that

$$\Pr(-k < Z < k) = \frac{C}{100}$$

Short-answer questions

- 1 Suppose that X is a random variable with mean $\mu = 15$ and variance $\sigma^2 = 25$.

- a Let $Y = 2X + 1$. Find $E(Y)$ and $\text{Var}(Y)$.
- b Let $U = 10 - 3X$. Find $E(U)$ and $\text{sd}(U)$.
- c Let $V = Y + 2U$. Find $E(V)$ and $\text{Var}(V)$.

- 2 A continuous random variable X has probability density function:

$$f(x) = \begin{cases} 2 \left(1 - \frac{1}{x^2} \right) & \text{if } 1 \leq x \leq 2 \\ 0 & \text{if } x < 1 \text{ or } x > 2 \end{cases}$$

- a Find $\Pr(X \leq 1.6)$.
 - b Let $Y = 2X - 1$. Find $\Pr(Y \leq 2.5)$.
- 3 The final marks in a mathematics examination are normally distributed with mean 65 and standard deviation 7. A random sample of 10 students are selected and their mean mark calculated. What are the mean and standard deviation of this sample mean?
- 4 The number of customers per day at a fast-food outlet is known to be normally distributed with a standard deviation of 50. In a sample of 25 randomly chosen days, an average of 155 customers were served.
- a Give a point estimate for μ , the mean number of customers served per day.
 - b Write down an expression for a 95% confidence interval for μ .

- 5** A manufacturer knows that the lifetimes of their light bulbs are normally distributed with a standard deviation of 150 hours.
- What size sample is required to ensure a margin of error of $M = 20$ hours at the 95% confidence level?
 - If the number of light bulbs in the sample were doubled, what would be the effect on the margin of error, M ?
- 6** Suppose that 60 independent random samples are taken from a large population and a 95% confidence interval for the population mean is computed from each of them.
- How many of the 95% confidence intervals would you expect to contain the population mean μ ?
 - Write down an expression for the probability that all 60 confidence intervals contain the population mean μ .



Multiple-choice questions



- 1** An aeroplane is only allowed a total passenger weight of 10 000 kg. If the weights of people are normally distributed with a mean of 80 kg and a standard deviation of 10 kg, the probability that the combined weight of 100 passengers will exceed 10 000 kg is
- A** 0.0228 **B** 0.0022 **C** 0 **D** 0.9772 **E** 0.0013
- 2** The time required to assemble an electronic component is normally distributed, with a mean of 10 minutes and a standard deviation of 1.5 minutes. The probability that the time required to assemble a box of 12 components is greater than 130 minutes is
- A** 0.2892 **B** 0.7108 **C** 0.0092 **D** 0.9910 **E** 0.0271
- 3** Suppose that X is a random variable with mean $\mu = 3.6$ and variance $\sigma^2 = 1.44$. If $Y = 3 - 4X$, then $E(Y)$ and $sd(Y)$ are
- A** $E(Y) = -11.4$, $sd(Y) = 4.8$ **B** $E(Y) = -11.4$, $sd(Y) = 5.76$
C $E(Y) = -11.4$, $sd(Y) = 23.04$ **D** $E(Y) = -3.6$, $sd(Y) = 4.8$
E $E(Y) = -3.6$, $sd(Y) = 5.76$
- 4** The monthly mortgage payments for recent home buyers are normally distributed with mean $\mu = \$1732$ and standard deviation $\sigma = \$554$. A random sample of 100 recent home buyers is selected. The distribution of the mean of this sample is
- A** normal with mean $\$17.32$ and standard deviation $\$5.54$
B normal with mean $\$1732$ and standard deviation $\$55.40$
C normal with mean $\$1732$ and standard deviation $\$5.54$
D normal with mean $\$173.20$ and standard deviation $\$55.40$
E normal with mean $\$1732$ and standard deviation $\$554$

- 5** Which of the following is a statement of the central limit theorem?
- A** If the sample size is large, then the distribution of the sample can be closely approximated by a normal curve.
 - B** If the sample size is large and the population is normal, then the variance of the sample mean must be small.
 - C** If the sample size is large, then the sampling distribution of the sample mean can be closely approximated by a normal curve.
 - D** If the sample size is large and the population is normal, then the sampling distribution of the sample mean can be closely approximated by a normal curve.
 - E** If the sample size is large, then the variance of the sample mean must be small.
- 6** The central limit theorem tells us that the sampling distribution of the sample mean is approximately normal. Which of the following conditions are necessary for the theorem to be valid?
- A** The sample size has to be sufficiently large.
 - B** We have to be sampling from a normal population.
 - C** The population distribution has to be symmetric.
 - D** The population variance has to be small.
 - E** both A and C
- 7** The sampling distribution of the sample mean refers to
- A** the distribution of the various sample sizes which might be used in a given study
 - B** the distribution of the different possible values of the sample mean together with their respective probabilities of occurrence
 - C** the distribution of the values of the random variable in the population
 - D** the distribution of the values of the random variable in a given sample
 - E** none of the above
- 8** The amount of money that customers spend at the supermarket each week in a certain town is known to be normally distributed with a standard deviation of \$84. If the average amount spent by a random sample of 50 customers is \$162, then a 95% confidence interval for the population mean is
- A** (\$39.10, \$128.90)
 - B** (-\$233.50, \$401.51)
 - C** (\$151.31, \$172.69)
 - D** (\$138.72, \$185.28)
 - E** (\$15.36, \$84.64)
- 9** A random sample of 100 observations is taken from a population known to be normally distributed with a standard deviation of 25. If the sample mean is 45, then the margin of error in a 95% confidence interval calculated from these data would be
- A** 4.9
 - B** 0.49
 - C** 0.98
 - D** 40.1
 - E** 9.8

- 10** In order to be 95% confident that the sample mean is within 1.4 of the population mean when a random sample is drawn from a population with a standard deviation of 6.7, the size of the sample should be
A 10 **B** 14 **C** 56 **D** 67 **E** 88
- 11** If 50 random samples are chosen from a population and a 90% confidence interval for the population mean μ is computed from each sample, then on average we would expect the number of intervals which contain μ to be
A 50 **B** 48 **C** 45 **D** 40 **E** none of these
- 12** If the sample mean remains unchanged, then an increase in the level of confidence will lead to a confidence interval which is
A narrower **B** wider **C** unchanged **D** asymmetric
E cannot be determined from the information given
- 13** Which of the following statements is true?
 I The centre of a confidence interval is a population parameter.
 II The bigger the margin of error, the smaller the confidence interval.
 III The confidence interval is a type of point estimate.
 IV The true value of a population mean is an example of a point estimate.
A I only **B** II only **C** III only **D** IV only **E** none of these
- 14** If a researcher increases her sample size by a factor of 4, then the width of a 95% confidence interval would
A increase by a factor of 2 **B** increase by a factor of 4 **C** decrease by a factor of 2
D decrease by a factor of 4 **E** none of these



Extended-response questions

- 1** Jan uses the lift in her multi-storey office building each day. She has noted that, when she goes to her office each morning, the time she waits for the lift is normally distributed with a mean of 60 seconds and a standard deviation of 20 seconds.
- a** What is the probability that Jan will wait less than 54 seconds on a particular day?
- b** Find a and b such that the probability that Jan waits between a seconds and b seconds is 0.95.
- c** During a five-day working week, find the probability that:
- i** Jan's average waiting time is less than 54 seconds
 - ii** Jan's total waiting time is less than 270 seconds
 - iii** she waits for less than 54 seconds on more than two days in the week.
- d** Find c and d such that there is a probability of 0.95 that her average waiting time over a five-day period is between c seconds and d seconds.

- 2** The daily rainfall in Brisbane is normally distributed with mean μ mm and standard deviation σ mm. The rainfall on one day is independent of the rainfall on any other day. On a randomly selected day, there is a 5% chance that the rainfall is more than 10.2 mm. In a randomly selected seven-day week, there is a probability of 0.025 that the mean daily rainfall is less than 6.1 mm. Find the values of μ and σ .
- 3** An aeroplane is licensed to carry 100 passengers.
- a** If the weights of passengers are normally distributed with a mean of 80 kg and a standard deviation of 20 kg, find the probability that the combined weight of 100 passengers will exceed 8500 kg.
 - b** The weight of the luggage that passengers check in before they travel is normally distributed, with a mean of 27 kg and a standard deviation of 4 kg. Find the probability that the combined weight of the checked luggage of 100 passengers is more than 2850 kg.
 - c** Passengers are also allowed to take hand luggage on the plane. The weight of the hand luggage that they carry is normally distributed, with a mean of 8 kg and a standard deviation of 2.5 kg. Find the probability that the combined weight of the hand luggage for 100 passengers is more than 900 kg.
 - d** What is the probability that the combined weight of the 100 passengers, their checked luggage and their hand luggage is more than 12 000 kg?
- 4** **a** Researchers have established that the time it takes for a certain drug to cure a headache is normally distributed, with a mean of 14.5 minutes and a standard deviation of 2.4 minutes. Find the probability that:
- i** in a random sample of 20 patients, the mean time for the headache to be cured is between 12 and 15 minutes
 - ii** in a random sample of 50 patients, the mean time for the headache to be cured is between 12 and 15 minutes.
- b** The researchers modify the formula for the drug, and carry out some trials to determine the new mean time for a headache to be cured.
- i** Determine a 95% confidence interval for the mean time for a headache to be cured, if the average time it took for the headache to be cured in a random sample of 20 subjects was 12.5 minutes. (Assume that $\sigma = 2.4$.)
 - ii** Determine a 95% confidence interval for the mean time for a headache to be cured, if the average time it took for the headache to be cured in a random sample of 50 subjects was 13.5 minutes. (Assume that $\sigma = 2.4$.)
 - iii** Determine a 95% confidence interval for the mean time for a headache to be cured based on the combined data from the two studies in **i** and **ii**.
 - iv** In order to ensure a margin of error of 0.5 minutes at the 95% confidence level, what size sample should the researchers use to determine the mean time to cure a headache for the new drug?

- 5** A sociologist asked randomly selected workers in two different industries to fill out a questionnaire on job satisfaction. The answers were scored from 1 to 20, with higher scores indicating greater job satisfaction.
- The scores on the questionnaire for industry A are known to be normally distributed with a standard deviation of 2.2.
 - The scores on the questionnaire for industry B are known to be normally distributed with a standard deviation of 3.1.

This information, together with the sample sizes used and the means obtained from the samples, is given in the following table.

Industry	n	σ	Sample mean
A	30	2.2	15.3
B	35	3.1	12.1

- a**
- i** Find a 95% confidence interval for μ_A , the mean satisfaction score in industry A.
 - ii** Find a 95% confidence interval for μ_B , the mean satisfaction score in industry B.
 - iii** Compare the two confidence intervals. Do they seem to indicate that there is a difference in job satisfaction in the two industries?
- b** To properly compare the two industries, we should determine a confidence interval for the difference in the means between the two industries, that is, for $\mu_A - \mu_B$.
- i** What is a point estimate of $\mu_A - \mu_B$?
 - ii** Determine the standard deviation of $X_A - X_B$, the difference between a score from industry A and a score from industry B.
 - iii** Use this information to construct a 95% confidence interval for $\mu_A - \mu_B$.
 - iv** Interpret this interval in the context of the random variables in this situation.



200

Revision of Chapters 1–19

20A Short-answer questions

- 1 Let $f: \mathbb{R} \setminus \{\frac{1}{2}\} \rightarrow \mathbb{R}$ where $f(x) = \frac{3}{2x-1} + 3$. Find f^{-1} , the inverse function of f .
- 2 Let $g: \mathbb{R} \rightarrow \mathbb{R}$, $g(x) = 3 - e^{2x}$.
 - a Find the rule and domain of the function g^{-1} .
 - b Sketch the graph of $y = g(g^{-1}(x))$ for its maximal domain.
- 3 Let ℓ be the line with vector equation $\mathbf{r} = -8\mathbf{i} + 4\mathbf{j} + 10\mathbf{k} + t(\mathbf{i} + 7\mathbf{j} - 2\mathbf{k})$, $t \in \mathbb{R}$, and let Π be the plane with Cartesian equation $12x - 2y - z = 17$. Show that the line ℓ and the plane Π do not intersect.
- 4 The line given by $\mathbf{r} = 2\mathbf{i} - 2\mathbf{j} + \mathbf{k} + t(-3\mathbf{i} + 9\mathbf{j} + \mathbf{k})$, $t \in \mathbb{R}$, crosses the x - z plane and the y - z plane at the points A and B respectively. What is the length of the line segment AB ?
- 5 Find a vector equation that represents the line of intersection of the planes defined by the equations $3x - y + 2z = 100$ and $x + 3y = 45$.
- 6 Determine the distance between the two parallel lines $5x + 5y - 11 = 0$ and $x + y - 1 = 0$ in the Cartesian plane.
- 7 Consider the following system of linear equations, where m is a constant:

$$\begin{aligned} x + 5y - 6z &= 2 \\ mx + y - z &= 0 \\ 5x - my + 3z &= 7 \end{aligned}$$

For what value of m does this system have a unique solution?
- 8 Find the gradient of the curve $2y^2 - xy^3 = 8$ at the point where $y = -1$.

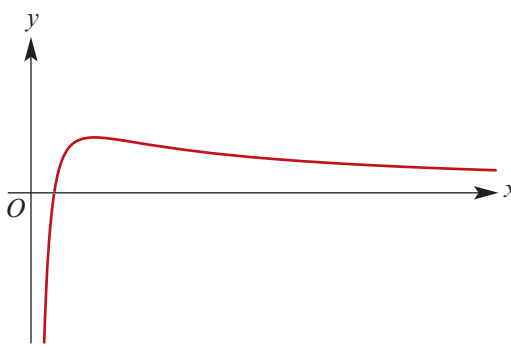
- 9 Let $f(x) = 4 \arccos(2x - 1)$. Find:
- a the maximal domain
 - b the range
 - c the value of $f(\frac{1}{2})$
 - d the value of a such that $f(a) = 3\pi$
 - e the equation of the tangent to the graph at the point where $x = \frac{1}{2}$.
- 10 A tank originally holds 40 litres of water, in which 10 grams of a chemical is dissolved. Pure water is poured into the tank at 4 litres per minute. The mixture is well stirred and flows out at 6 litres per minute until the tank is empty.
- a State how long it takes the tank to empty.
 - b Set up a differential equation for the mass, m grams, of chemical in the tank at time t minutes, including the initial condition.
 - c Express m in terms of t .
 - d Hence determine how long it takes for the concentration of the solution to reach 0.2 grams per litre.
- 11 For the graph of $f(x) = \frac{x+3}{x^2+3}$, find:
- a the equations of any asymptotes
 - b the coordinates of any stationary points
 - c the area bounded by the x -axis, the y -axis, the line $x = 3$ and the graph of $y = f(x)$.
- 12 a Find:
- i $(5+i)(4+i)$
 - ii $(\sqrt{3}+i)(-2\sqrt{3}+i)$
 - iii $(\frac{1}{2}+i)(-\frac{3}{4}+i)$
 - iv $(1.2-i)(0.4+i)$
- b Let $z = a + i$ and $w = b + i$, where both a and b are integers.
- i Find zw , in terms of a and b .
 - ii If $\operatorname{Re}(zw) = \operatorname{Im}(zw)$, express b in terms of a .
 - iii Hence sketch the graph of b against a .
- 13 The graph of $y = \frac{\ln x}{x}$ is shown. Point P is the stationary point, and Q is the point of intersection of the graph with the x -axis.
- 
- a Find the coordinates of P and Q .
 - b Find the area of the region bounded by the x -axis, the curve and the line $x = e$.
- 14 The random variables X_1 and X_2 are independent and normally distributed, with means $\mu_{X_1} = \mu_{X_2} = 18$ and variances $\sigma_{X_1}^2 = \sigma_{X_2}^2 = 4$. Find:
- a $E(2X_1 + 5)$
 - b $\operatorname{Var}(2X_1 + 5)$
 - c $E(X_1 + X_2)$
 - d $\operatorname{Var}(2X_1)$
 - e $\operatorname{Var}(X_1 + X_2)$

- 15 a** Solve the differential equation $\frac{dy}{dx} = e^{x+y}$, $y(1) = 1$, expressing y as a function of x .
- b** State the maximal domain of this function.
- c** Find the equation of the tangent to the curve at $x = 0$.
- 16 a** Solve $\frac{dy}{dx} = x(4 + y^2)$, where $y(0) = 2$, expressing y as a function of x .
- b** State the maximal domain of this function.
- c** Find the equation of the normal to the curve at $x = \frac{1}{2}\sqrt{\frac{\pi}{3}}$.
- 17 a** Express $\frac{x}{(1-x)^2}$ as partial fractions.
- b** Hence find the area of the region defined by the graphs of $y = \frac{x}{(1-x)^2}$, $x = 2$, $x = 4$ and the x -axis.
- 18 a** Show that $\frac{x}{\sqrt{x-1}} = \sqrt{x-1} + \frac{1}{\sqrt{x-1}}$.
- b** The graph of $f(x) = \frac{x}{\sqrt{x-1}}$, for $x \in [2, a]$, is rotated about the x -axis to form a solid of revolution. Find the volume of this solid in terms of a .
- 19** Determine the asymptotes, intercepts and stationary points for the graph of the relation $y = \frac{x^3 + 3x^2 - 4}{x^2}$. Hence sketch the graph.
- 20** Let P be a point on the line $x + y = 1$ and write $\overrightarrow{OP} = mi + nj$, where O is the origin and $m, n \in \mathbb{R}$.
- a** Find the unit vectors parallel to the line $x + y = 1$.
- b** Find a relation between m and n , and hence express \overrightarrow{OP} in terms of m only.
- c** Find the two values of m such that \overrightarrow{OP} makes an angle of 60° with the line $x + y = 1$.
- 21** Points A , B and C are represented by position vectors $i + 2j - k$, $2i + mj + k$ and $3i + 3j + k$ respectively.
- a** The position vector $r = \overrightarrow{OA} + t\overrightarrow{AC}$, $t \in \mathbb{R}$, can be used to represent any point on the line AC . Find the value of t for which r is perpendicular to \overrightarrow{AC} .
- b** Find the value of m such that $\angle BAC$ is a right angle.
- 22** Let $f(x) = \frac{4x^2 + 16x}{(x-2)^2(x^2+4)}$.
- a** Given that $f(x) = \frac{a}{x-2} + \frac{6}{(x-2)^2} - \frac{bx+4}{x^2+4}$, find a and b .
- b** Given that $\int_{-2}^0 f(x) dx = \frac{c - \pi - \ln d}{2}$, find c and d .
- 23** Calculate the area of the triangle XYZ , where the three vertices have coordinates $X(1, 3, 2)$, $Y(2, -1, 0)$ and $Z(1, 10, 6)$.

- 24** Find the acute angle between the planes given by $x - y + 3z = 2$ and $3x + y - z = -5$.
- 25** A particle is moving in a straight line such that its position, x metres, at time t seconds is given by $x = 3 - 2 \cos^2 t$.
- a** Show that the motion of the particle is simple harmonic.
- b** **i** Find the period of the motion.
ii Find the amplitude of the motion.
iii Find the maximum speed of the particle.
- 26** Find an antiderivative of each of the following:
- a** $(2x - 6)e^x$ **b** $x \ln(2x)$ **c** $x \sec^2(3x)$ **d** $x \tan^2(x)$
- 27** Evaluate each of the following definite integrals:
- a** $\int_0^1 x e^{3x} dx$ **b** $\int_0^{\frac{\pi}{2}} x \sin(3x) dx$ **c** $\int_0^{\pi} (2x - 2) \cos\left(\frac{x}{3}\right) dx$
- 28** A random variable X has probability density function f given by

$$f(x) = \begin{cases} 2(1-x) & \text{if } 0 \leq x \leq 1 \\ 0 & \text{otherwise} \end{cases}$$

Find $E(Y)$ if $Y =$

- a** X **b** X^2 **c** $4X + 1$ **d** $2X^2 - X$
- 29** The mass, X kg, of potting mix in a bag is a normally distributed random variable with mean 45 kg and standard deviation 5 kg. A sample of size 100 is taken from this normally distributed population. Describe the distribution of \bar{X} , the mean of this sample.

20B Multiple-choice questions

- 1** The function $f: [4, \infty) \rightarrow \mathbb{R}$, $f(x) = \ln(x - 3)$ is one-to-one. The domain of the inverse function of f is
- A** $[0, \infty)$ **B** $(0, \infty)$ **C** $[4, \infty)$ **D** $(3, \infty)$ **E** \mathbb{R}
- 2** The function $f: [a, \infty) \rightarrow \mathbb{R}$ with rule $f(x) = \ln((x - 2)^4)$ has an inverse function if
- A** $a \geq 3$ **B** $a \leq -2$ **C** $a < 2$ **D** $a \geq 0$ **E** $a \geq -1$
- 3** The simultaneous equations

$$(m - 2)x + 8y = 7$$

$$4x + (m + 2)y = m$$

have a unique solution for

- A** $m \in \mathbb{R} \setminus \{6, -6\}$ **B** $m \in \mathbb{R} \setminus \{0\}$ **C** $m \in \mathbb{R} \setminus \{2, -2\}$
D $m = 6$ **E** $m = -6$

- 4 A system of linear equations has an augmented matrix in row-echelon form as shown.

$$\begin{array}{r} x - 2y + 3z = 1 \\ x + ky + 2z = 2 \\ -2x + k^2y - 4z = 3k - 4 \end{array} \quad \left[\begin{array}{ccc|c} 1 & -2 & 3 & 1 \\ 0 & k+2 & -1 & 1 \\ 0 & 0 & k & 2k \end{array} \right]$$

This system has a unique solution for

- A** $k \in \mathbb{R}$ **B** $k \in \mathbb{R} \setminus \{-2, 0\}$ **C** $k = -2$
D $k = -2$ or $k = 0$ **E** $k \in \mathbb{R} \setminus \{0, 2\}$
- 5 A normal vector to the plane with Cartesian equation $8x + 6y - 3z = -12$ is
A $8i + 6j - 3k$ **B** $-8i - 6j - 3k$ **C** $6i + 3j - 8k$
D $-12i + 6j - 3k$ **E** $6i - 3j - 12k$
- 6 The stationary points of the function $f(x) = \frac{2x^2 - x + 1}{x - 1}$ occur when x equals
A 1 **B** 0 or 2 **C** 0 only **D** $\frac{1}{4}$ **E** -1
- 7 The point of inflection of the graph of $y = \frac{x^2 - 3x + 2}{x^2}$ has x -coordinate
A 0 **B** -1 **C** 1 **D** 2 **E** -2
- 8 The gradient of the curve with equation $x^3 + y^3 + 3xy = 1$ at the point $(2, -1)$ is
A 0 **B** -1 **C** 1 **D** -2 **E** 2
- 9 The graph of the function $f(x) = e^x \sin x$, $0 \leq x \leq \pi$, has a maximum gradient of
A 1 **B** $\frac{\pi}{2}$ **C** $e^{-\frac{\pi}{2}}$ **D** e^π **E** $e^{\frac{\pi}{2}}$
- 10 $(1 - \sqrt{3}i)^3 \div (1 + i)$ equals
A $-4 + 4i$ **B** -8 **C** $4 - 4i$ **D** $4\sqrt{2} \operatorname{cis}\left(\frac{5\pi}{4}\right)$ **E** $3 + 4i$
- 11 The solution of the equation $\frac{z - 2i}{z - (3 - 2i)} = 2$, where $z \in \mathbb{C}$, is $z =$
A $6 + 2i$ **B** $6 - 2i$ **C** $-6 - 6i$ **D** $6 - 6i$ **E** $-6 + 2i$
- 12 The polynomial $z^3 - 2z + 4$ can be factorised as
A $(z + 4)(z - 1)(z + 1)$ **B** $(z - 4)(z - i)(z + 1)$
C $(z - 1)(z + 1 + i)(z + 1 - i)$ **D** $(z + 2)(z + i)(z - i)$
E $(z + 2)(z - 1 + i)(z - 1 - i)$
- 13 If $\int_0^k xe^{-x} dx = 0.5$ and $k > 0$, then k is closest to
A 0.7 **B** 1.7 **C** 2.7 **D** 3.7 **E** 4.7
- 14 If $\frac{dy}{dx} = x \ln x$ with $y(2) = 2$, then $y(3)$ is closest to
A 4.31 **B** 2.3 **C** -1.7 **D** 0 **E** 1.3

- 15** The solution of the equation $\frac{\tan(2x)}{1 + \sec(2x)} = -\sqrt{3}$, for $0 \leq x \leq \pi$, is
A $\frac{\pi}{3}$ **B** $\frac{2\pi}{3}$ **C** $\frac{5\pi}{6}$ **D** $\frac{\pi}{4}$ **E** $\frac{3\pi}{4}$
- 16** In the interval $(-\pi, \pi)$, the number of points of intersection of the graphs of $f(x) = \sec x$ and $g(x) = \operatorname{cosec}(2x)$ is
A 0 **B** 1 **C** 2 **D** 3 **E** 4
- 17** The solution of the inequality $\cot\left(\frac{\theta}{2}\right) \geq \sqrt{3}$, for $-\pi \leq \theta \leq \pi$, is
A $\left(-\pi, \frac{\pi}{3}\right)$ **B** $\left[-\pi, \frac{\pi}{3}\right)$ **C** $\left[0, \frac{\pi}{3}\right]$ **D** $\left(0, \frac{\pi}{3}\right)$ **E** $\left[\frac{\pi}{3}, \pi\right]$
- 18** The velocity, v m/s, of a particle at time t seconds is given by $v = \frac{4t}{1+t^2}$, $t \geq 0$.
The distance, in metres, travelled by the particle in the first 10 seconds is closest to
A 9.23 **B** 533.33 **C** 1 **D** 2 **E** 1.73
- 19** A small rocket is fired vertically upwards. The initial speed of the rocket is 200 m/s.
The acceleration of the rocket, a m/s², is given by $a = -\frac{20+v^2}{50}$, where v m/s is the velocity of the rocket at time t seconds. The time that the rocket takes to reach the highest point, in seconds, is closest to
A 5 **B** 8 **C** 12 **D** 17 **E** 25
- 20** The graph of $y = -\sec(ax + b)$ is identical to the graph of $y = \operatorname{cosec}\left(x + \frac{\pi}{3}\right)$. The values of a and b could be
A $a = 1$ and $b = \frac{\pi}{6}$ **B** $a = -1$ and $b = \frac{\pi}{6}$ **C** $a = 1$ and $b = \frac{2\pi}{3}$
D $a = -1$ and $b = \frac{7\pi}{6}$ **E** none of these
- 21** $\frac{d}{dx}(x \ln y) - \frac{x}{y} \frac{dy}{dx} =$
A 0 **B** $\ln y$ **C** $x \ln y$ **D** $\ln y - \frac{x}{y} \frac{dy}{dx}$ **E** $\frac{1-x}{y} \frac{dy}{dx}$
- 22** The graph with parametric equations $x = 2 + 3 \sec(t)$ and $y = 1 + 2 \tan(t)$, where $t \in \left[0, \frac{\pi}{2}\right) \cup \left(\frac{\pi}{2}, \pi\right]$, has
A two asymptotes, $y = \frac{2x}{3} - \frac{1}{3}$ and $y = -\frac{2x}{3} + \frac{7}{3}$
B two asymptotes, $y = \frac{2}{3}(x-1)$ and $y = -\frac{2}{3}(x-1)$
C two asymptotes, $y-1 = \frac{3}{2}(x-2)$ and $y-1 = -\frac{3}{2}(x-2)$
D one asymptote, $y = \frac{2x}{3} - \frac{1}{3}$ **E** one asymptote, $3y = 7 - 2x$

- 23** Consider the vectors $\mathbf{a} = 2\mathbf{i} + 3\mathbf{j} - \mathbf{k}$, $\mathbf{b} = \mathbf{j} - 3\mathbf{k}$ and $\mathbf{c} = \mathbf{i} - 2\mathbf{j} - 2\mathbf{k}$. Solving the equation $3\mathbf{i} = m\mathbf{a} + n\mathbf{b} + p\mathbf{c}$ produces
- A** $m = 1, n = -1, p = 1$ and \mathbf{a}, \mathbf{b} and \mathbf{c} are linearly independent vectors
B $m = 1, n = \frac{3}{8}, p = \frac{1}{8}$ and \mathbf{a}, \mathbf{b} and \mathbf{c} are linearly independent vectors
C $m = 1, n = -1, p = 1$ and \mathbf{a}, \mathbf{b} and \mathbf{c} are linearly dependent vectors
D $m = 1, n = \frac{3}{8}, p = \frac{1}{8}$ and \mathbf{a}, \mathbf{b} and \mathbf{c} are linearly dependent vectors
E no values of m, n and p satisfy this equation
- 24** $\int_{\frac{\pi}{6}}^{\frac{2\pi}{3}} \cos^2(2x) dx$ is not equal to
- A** $\frac{1}{2} \int_{\frac{\pi}{3}}^{\frac{4\pi}{3}} \cos^2(x) dx$ **B** $\frac{\pi}{2} - \int_{\frac{\pi}{6}}^{\frac{2\pi}{3}} \sin^2(2x) dx$ **C** $\frac{1}{2} \int_{\frac{\pi}{6}}^{\frac{2\pi}{3}} 1 + \cos(4x) dx$
D $\int_{\frac{\pi}{6}}^{\frac{2\pi}{3}} \sin^2(\frac{1}{2}(\pi - 4x)) dx$ **E** $\left[\frac{1}{6} \cos^3(2x) \right]_{\frac{\pi}{6}}^{\frac{2\pi}{3}}$
- 25** A hyperbola has asymptotes given by the equations $y = \pm \frac{3}{2}(x + 1) + 3$ and passes through the origin. The equation of the hyperbola is
- A** $\frac{4(y - 3)^2}{27} - \frac{(x + 1)^2}{3} = 1$ **B** $\frac{(y - 3)^2}{9} - \frac{(x + 1)^2}{4} = 1$
C $\frac{(x + 1)^2}{4} - \frac{(y - 3)^2}{9} = 1$ **D** $\frac{3(x + 1)^2}{16} - \frac{(y - 3)^2}{12} = 1$
E $\frac{y^2}{27} - \frac{(x + 1)^2}{12} = 1$
- 26** An ellipse has a horizontal semi-axis length of 4 units and a vertical semi-axis length of 2 units. The centre of the ellipse is $(-2, 1)$. The pair of parametric equations which cannot represent this ellipse is
- A** $x = -2 + 4 \cos(t)$ and $y = 1 - 2 \sin(t)$ **B** $x = -2 + 4 \cos(t)$ and $y = 1 + 2 \sin(t)$
C $x = -2 + 2 \cos(2t)$ and $y = 1 + \sin(2t)$ **D** $x = -2 - 4 \sin(2t)$ and $y = 1 - 2 \cos(2t)$
E $x = -2 + 4 \sin(t - 1)$ and $y = 1 + 2 \cos(t - 1)$
- 27** Let $z = a + bi$, where $a, b \in \mathbb{R}$. If $z^2(1 + i) = 2 - 2i$, then the Cartesian form of one value of z could be
- A** $\sqrt{2}i$ **B** $-\sqrt{2}i$ **C** $-1 - i$ **D** $-1 + i$ **E** $\sqrt{-2}$
- 28** A block of ice is pulled from rest along a smooth horizontal surface by a constant horizontal force of F newtons. The ice block initially has a mass of m kg, but gradually melts as it is pulled, losing mass at the rate of c kg per second. Let x m and v m/s represent the position and velocity of the ice block after t seconds. An appropriate differential equation for the motion of the ice block after t seconds could be
- A** $\frac{dv}{dt} = \frac{F}{m - ct}$ **B** $\frac{dv}{dt} = \frac{F}{m}$ **C** $\frac{dv}{dx} = \frac{F}{m - c}$
D $\frac{dv}{dt} = \frac{F}{v(m - ct)}$ **E** $\frac{dv}{dt} = \frac{F}{m} - ct$

- 29** Let $\mathbf{a} = pi + qj + k$ and $\mathbf{b} = i - 2j + 2k$. If the scalar resolute of \mathbf{a} in the direction of \mathbf{b} is $\frac{2}{3}$ and the scalar resolute of \mathbf{b} in the direction of \mathbf{a} is 2, then the values of p and q are
A $p = 0$ and $q = 0$ **B** $p = 2 - \sqrt{7}$ and $q = \sqrt{7}$
C $p = \frac{8 + \sqrt{10}}{5}$ and $q = \frac{4\sqrt{10}}{5}$ **D** $p = 1$ and $q = 0.5$
E $p = -2$ and $q = -1$

- 30** The gradient of the tangent to the graph of $y = e^{xy}$ at the point where $x = 0$ is
A 0 **B** 1 **C** 2 **D** $\ln 2$ **E** undefined

- 31** A particle is projected up a rough plane inclined at 40° to the horizontal with an initial speed of 16 m/s. It comes instantaneously to rest after 2.3 seconds. The coefficient of friction between the particle and the plane, given to three decimal places, is
A 0.927 **B** 0.644 **C** 0.379 **D** 0.088 **E** cannot be found

- 32** Let $f(x) = a \cos(x + c)$ for $x \in [\pi - c, \frac{3\pi}{2} - c]$, where $a > 0$. Then $f^{-1}(x) =$
A $a \cos^{-1}(x - c)$ **B** $\cos^{-1}\left(\frac{x}{a} - c\right)$ **C** $\pi - c - \cos^{-1}\left(\frac{x}{a}\right)$
D $\pi + c - \cos^{-1}\left(\frac{x}{a}\right)$ **E** $2\pi - c - \cos^{-1}\left(\frac{x}{a}\right)$

- 33** The position of a particle at time t seconds is defined by $\mathbf{r} = \frac{a}{t + 1} \mathbf{i} + (1 + t^2)\mathbf{j}$, $t \geq 0$, where $a > 0$. The Cartesian equation which represents the path of the particle is
A $y = \frac{a^2}{x^2}$, for $x \in [0, \infty)$ **B** $y = \frac{a^2 - 2ax + 2x^2}{x^2}$, for $x \in [a, \infty)$
C $y = \left(\frac{a}{x} - 1\right)^2 + 1$, for $x \in (0, a]$ **D** $y = \frac{x^2 - 2ax + 2a^2}{a^2}$, for $x \in \mathbb{R} \setminus \{-1\}$
E $y = \frac{a^2}{(x - 1)^2} + 1$, for $x \in [0, \infty)$

- 34** Using an appropriate substitution, the integral $\int_1^2 x(2 - x)(x^3 - 3x^2 + 4) dx$ can be expressed as
A $3 \int_1^2 u du$ **B** $\frac{1}{3} \int_2^1 u du$ **C** $\frac{1}{6} \int_2^0 u^2 du$ **D** $\int_2^0 3u du$ **E** $-\frac{1}{3} \int_2^0 u du$

- 35** This is the slope field for a differential equation, produced by a calculator, with $0 \leq x \leq 2$ and $-3 \leq y \leq 3$.

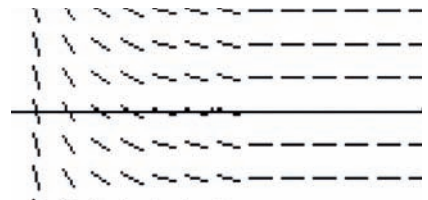

A solution for the differential equation could be

- A** $y = -\frac{1}{x^2}$ **B** $y = -\frac{1}{x^3}$ **C** $y = \frac{1}{x}$ **D** $y = e^x$ **E** $y = -\frac{1}{\sqrt{x}}$

- 36** This is the slope field for a differential equation, produced by a calculator, with $-\pi \leq x \leq \pi$ and $-3 \leq y \leq 3$.

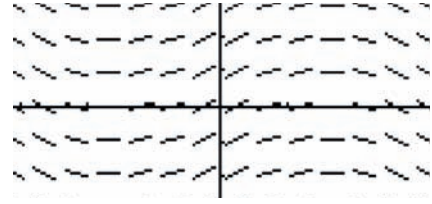

The differential equation could be

- A** $\frac{dy}{dx} = \sin x$ **B** $\frac{dy}{dx} = -\cos x$ **C** $\frac{dy}{dx} = \tan x$ **D** $\frac{dy}{dx} = \sin(2x)$ **E** $\frac{dy}{dx} = \cos x$

- 37** This is the slope field for a differential equation, produced by a calculator, with $-3 \leq x \leq 3$ and $-3 \leq y \leq 3$.

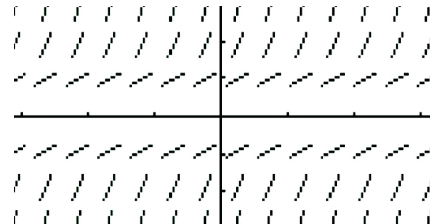

A solution for the differential equation could be

- A** $y = \frac{1}{x}$ **B** $x = y^3$ **C** $y = \frac{1}{x^2}$ **D** $x = -\frac{1}{y}$ **E** $x = \ln y$

- 38** This is the slope field for a differential equation, produced by a calculator, with $-3 \leq x \leq 3$ and $-3 \leq y \leq 3$.

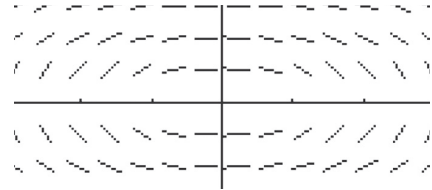

The differential equation could be

- A** $\frac{dy}{dx} = x^2$ **B** $\frac{dy}{dx} = -\frac{y}{x}$ **C** $\frac{dy}{dx} = \frac{y}{x}$ **D** $\frac{dy}{dx} = \frac{x}{y}$ **E** $\frac{dy}{dx} = -\frac{x}{y}$

- 39** A particle is projected at an angle of $\arctan\left(\frac{3}{4}\right)$ to the horizontal with a speed of 40 m/s. After 2 seconds, the particle is moving in a direction at an angle of θ to the horizontal. If the acceleration due to gravity is taken as $g = 10 \text{ m/s}^2$, then $\tan \theta$ is equal to

- A** $\frac{1}{8}$ **B** $\frac{1}{2}$ **C** 2 **D** 4 **E** 8

- 40** A particle is oscillating between the two positions $x = 2 \text{ m}$ and $x = 8 \text{ m}$ with simple harmonic motion. If the period of the motion is $\frac{\pi}{2}$ seconds, then the maximum speed of the particle is

- A** 12 m/s **B** 3 m/s **C** 4 m/s **D** 6 m/s **E** 2 m/s

- 41** Which one of the following points is equidistant from the two planes given by the equations $-2x + y - 2z + 3 = 0$ and $-2x + y - 2z + 21 = 0$?

- A** (4, 3, 4) **B** (2, 4, 6) **C** (3, -5, 5) **D** (1, 3, 5) **E** (-1, 4, -6)

- 42** The weight of a certain type of large dog is normally distributed with mean 42 kg and standard deviation 4.5 kg. The probability that the average weight of 20 of these dogs, randomly selected, is between 38 kg and 43 kg is closest to

- A** 0.8398 **B** 0.4009 **C** 0.7564 **D** 0.6862 **E** 0.9332

- 43** For a statistician to be 99% confident that the sample mean will differ by less than 0.3 units from the population mean, given that the population standard deviation is 1.365, the minimum sample size should be
- A** 56 **B** 80 **C** 113 **D** 138 **E** 145

20C Extended-response questions

- 1** The points A , B and C have position vectors $\mathbf{a} = \mathbf{i} + 2\mathbf{j} + 2\mathbf{k}$, $\mathbf{b} = 2\mathbf{i} + \mathbf{j} + 2\mathbf{k}$ and $\mathbf{c} = 2\mathbf{i} + 2\mathbf{j} + \mathbf{k}$ respectively, with respect to an origin O .
- Find a vector equation of the line BC .
 - Find a vector equation of the plane Π that contains the point A and is perpendicular to the line OA .
 - Show that the line BC is parallel to the plane Π .
 - A circle with centre O passes through A and B . Find the length of the minor arc AB .
 - Verify that $2\mathbf{i} + 2\mathbf{j} - 3\mathbf{k}$ is perpendicular to the plane OAB . Write down a vector perpendicular to the plane OAC . Hence, find the acute angle between the planes OAB and OAC .
- 2** The plane Π_1 is given by the Cartesian equation $3x + 2y - z = -1$, and the line ℓ_1 is given by the vector equation $\mathbf{r} = (4 - t)\mathbf{i} + (2t - 3)\mathbf{j} + (t + 7)\mathbf{k}$, $t \in \mathbb{R}$.
- Show that the line ℓ_1 lies in the plane Π_1 .
- The line ℓ_2 is given by the vector equation $\mathbf{r} = 10\mathbf{j} + 7\mathbf{k} + t(\mathbf{i} + 3\mathbf{j} + 2\mathbf{k})$, $t \in \mathbb{R}$, and the line ℓ_2 intersects the plane Π_1 at the point A .
- Find the coordinates of the point A .
 - Find a Cartesian equation of the plane Π_2 that passes through the point A and is perpendicular to the line ℓ_1 .
 - Find the coordinates of the point where the line ℓ_1 intersects the plane Π_2 .
 - Find a vector equation of the line ℓ_3 that lies in the plane Π_1 and is perpendicular to the line ℓ_1 .
- 3** A plane Π_1 in three-dimensional space has vector equation $\mathbf{r} \cdot (2\mathbf{i} + 3\mathbf{j}) = -6$.
- Find a vector equation of the line that is normal to Π_1 and passes through $P(2, 1, 4)$.
 - Find the coordinates of Q , the foot of the perpendicular on Π_1 from the point P .
 - Find the sine of the angle between OQ and Π_1 .
 - Planes Π_2 and Π_3 have vector equations $\mathbf{r} \cdot (\mathbf{i} + \mathbf{j} + \mathbf{k}) = 5$ and $\mathbf{r} \cdot \mathbf{i} = 0$ respectively. Find the point of intersection of the three planes Π_1 , Π_2 and Π_3 .
- 4** The volume of liquid in a 1 litre bottle is normally distributed with a mean of μ litres and a standard deviation of σ litres. In a randomly selected bottle, there is a probability of 0.057 that there is more than 1.02 litres. In a randomly selected six-pack of bottles, there is a probability of 0.033 that the mean volume of liquid is more than 1.01 litres. Find the values of μ and σ .

- 5** Suppose that people's weights, X kg, are normally distributed with a mean of 80 kg and a standard deviation of 20 kg.
- Find k_1 and k_2 such that, for a person chosen at random, $\Pr(k_1 < X < k_2) = 0.95$.
 - Suppose that we plan to take a random sample of 20 people and determine their mean weight, \bar{X} . Find c_1 and c_2 such that $\Pr(c_1 < \bar{X} < c_2) = 0.95$.
 - Suppose that researchers are no longer sure that the mean weight of people is 80 kg. They believe that it might have changed, due to changes in diet. To investigate this possibility, they take a random sample of 20 people and determine a sample mean of 85 kg. Based on this value (and a standard deviation of 20 kg), determine a 95% confidence interval for the mean.
- 6** The length of a rectangular tile is a normal random variable with mean 20 cm and standard deviation 0.1 cm. The width is an independent normal random variable with mean 10 cm and standard deviation 0.1 cm.
- Find the probability that the sum of the lengths of four randomly chosen tiles exceeds 80 cm.
 - Find the probability that the width of a randomly chosen tile is less than half its length.
 - Let S be the random variable formed from the sum of the lengths of 50 randomly chosen tiles, and let T be the random variable formed from the sum of the widths of 80 randomly chosen tiles. Find the mean and variance of $S - T$.

- 7** Consider the function

$$f(x) = \begin{cases} x \ln x - 3x & \text{if } x > 0 \\ 0 & \text{if } x = 0 \end{cases}$$

- Find the derivative for $x > 0$.
 - One x -axis intercept is at $(0, 0)$. Find the coordinates of the other x -axis intercept, A .
 - Find the equation of the tangent at A .
 - Find the ratio of the area of the region bounded by the tangent and the coordinate axes to the area of the region bounded by the graph of $y = f(x)$ and the x -axis.
- 8** **a** Consider $y = \frac{a + b \sin x}{b + a \sin x}$, where $0 < a < b$.
- Find $\frac{dy}{dx}$.
 - Find the maximum and minimum values of y .
- b** For the graph of $y = \frac{1 + 2 \sin x}{2 + \sin x}$, $-\pi \leq x \leq 2\pi$:
- State the coordinates of the y -axis intercept.
 - Determine the coordinates of the x -axis intercepts.
 - Determine the coordinates of the stationary points.
 - Sketch the graph of $y = f(x)$.
 - Find the area of the region bounded by the graph and the line $y = -1$.

- 9 Consider the function

$$f(x) = \cos x + \sqrt{3} \sin x, \quad 0 \leq x \leq 2\pi$$

Given that $f(x)$ can be expressed in the form $r \cos(x - a)$, where $r > 0$ and $0 < a < \frac{\pi}{2}$:

- a** Find the values of r and a .
- b** Find the range of the function.
- c** Find the coordinates of the y -axis intercept.
- d** Find the coordinates of the x -axis intercepts.
- e** Find x , if $f(x) = \sqrt{2}$.
- f** If $g(x) = \frac{1}{f(x)}$, evaluate $\int_0^{\frac{\pi}{2}} g(x) dx$.
- g** Find the volume measure of the solid formed when the region bounded by the graph of $y = f(x)$, the x -axis and the y -axis is rotated about the x -axis.
- 10 A particle moves in a line such that the velocity, v m/s, at time t seconds ($t \geq 0$) satisfies the differential equation $\frac{dv}{dt} = \frac{-v}{50}(1 + v^2)$. The particle starts from O with an initial velocity of 10 m/s.
- a i** Express as an integral the time taken for the particle's velocity to decrease from 10 m/s to 5 m/s.
- ii** Hence calculate the time taken for this to occur.
- b i** Show that, for $v \geq 0$, the motion of this particle is described by the differential equation $\frac{dv}{dx} = \frac{-(1 + v^2)}{50}$, where x metres is the displacement from O .
- ii** Given that $v = 10$ when $x = 0$, solve this differential equation, expressing x in terms of v .
- iii** Hence show that $v = \frac{10 - \tan\left(\frac{x}{50}\right)}{1 + 10 \tan\left(\frac{x}{50}\right)}$.
- iv** Hence find the displacement of the particle from O , to the nearest metre, when it first comes to rest.
- 11 **a i** Find the derivative of $x \cos(\pi x)$.
- ii** Hence use calculus methods to find an antiderivative of $x \sin(\pi x)$.
- Let $f(x) = \sin(\pi x) + px$, $x \in [0, 1]$.
- b i** Find the value of p for which $f'(1) = 0$.
- ii** Hence show that $f'(x) \geq 0$ for $x \in [0, 1]$.
- c** Sketch the graph of $y = f(x)$, $x \in [0, 1]$.
- d** Find the exact value for the volume of revolution formed when the graph of $y = f(x)$, $x \in [0, 1]$, is rotated around the x -axis.
- e** For $g(x) = k \arcsin(x)$, $x \in [0, 1]$, find the value of k such that $f(1) = g(1)$.
- f** Find the area of the region enclosed by the graphs of $y = f(x)$ and $y = g(x)$, correct to three decimal places.
- g** If $f(x) - g(x)$ has a maximum at $x = a$, find a , correct to three decimal places.

- 12** A particle of mass 4 kg, lying on a smooth plane inclined at 30° to the horizontal, is connected by a light string over a pulley to a container full of water, as shown in the diagram. The mass of the container and water is 3 kg.

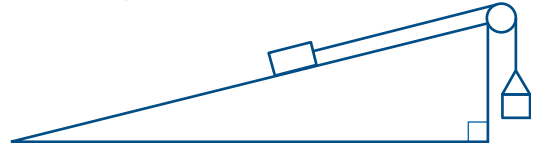

- a** If $b \text{ m/s}^2$ is the acceleration of the container downwards and $T \text{ N}$ is the tension in the string:
- Write down the two equations of forces on the particle and the container.
 - Find the values of b and T .
- The 4 kg particle is placed at the bottom of the slope, which is 100 m long, and then the connected objects are released from rest. Immediately, the container springs a leak, which expels water at the rate of 0.1 kg/s.
- b**
- Find the mass of the container after t seconds.
 - Write down the forces equation for the container, where $a \text{ m/s}^2$ represents its acceleration downwards and $T_1 \text{ N}$ represents the tension in the string at time t seconds.
 - Write down the corresponding forces equation for the 4 kg particle.
 - Hence find an expression for a in terms of t .
- c** Using $a = \frac{dv}{dt}$, where $v \text{ m/s}$ is the velocity of the particle at time t seconds, write down a differential equation for v and solve it to express v in terms of t .
- d** Find, correct to three decimal places, the time taken by the particle before it is again instantaneously at rest.
- e** Find, correct to three decimal places, the distance the particle travelled up the plane in that time.
- 13** The complex number $z_1 = \sqrt{3} - 3i$ is a solution of the equation $z^3 + a = 0$.
- a**
- Find the value of a .
 - Hence find the other solutions z_2 and z_3 , where z_2 is real.
- b** Plot the solutions on an Argand diagram.
- c** A set of points on the Argand diagram is defined by the equation
- $$|z - z_1| + |z - z_3| = b$$
- This set of points includes the point z_2 . Show that the value of b is 12.
 - Hence find the two complex numbers on the line through z_1 and z_3 which belong to this set of points.
 - Hence or otherwise, and using $z = x + yi$, find the Cartesian equation of the set of points.

- 14** Points A and B are represented by position vectors $\mathbf{a} = 2\mathbf{i} - \mathbf{j} + 2\mathbf{k}$ and $\mathbf{b} = m(\mathbf{i} + \mathbf{j} - \mathbf{k})$ respectively, relative to a point O , where $m > 0$.

a Find the value of m for which A and B are equidistant from O .

Points A and B lie on a circle with centre O . Point C is represented by the position vector $-\mathbf{a}$.

- b i** Give reasons why C also lies on the circle.
ii By using the scalar product, show that $\angle ABC = 90^\circ$.

Now assume that all points on this circle can be represented by the general position vector $\mathbf{d} = k\mathbf{a} + \ell\mathbf{b}$, for different values of k and ℓ .

- c i** Show that the relation between k and ℓ is given by $9k^2 - 2\sqrt{3}k\ell + 9\ell^2 = 9$.
ii When $k = 1$, find the two position vectors that represent points on the circle.
d Let P be a point on the circle such that OP bisects AB . Find the position vectors which represent P . Do not attempt to simplify your answer.

A particle is travelling such that its position at time t seconds is given by

$$\mathbf{r} = (5 - t)\mathbf{i} + (2 + t)\mathbf{j} + (t - 3)\mathbf{k}.$$

- e** Find the value of t when \mathbf{r} can be expressed in the form $k\mathbf{a} + \ell\mathbf{b}$, and find the corresponding values of k and ℓ .
f Hence determine whether the particle lies inside, outside or on this circle at this time.

- 15** A curve is defined by the parametric equations $x = 3 \sin(t)$ and $y = 6 \cos(t) - a$, where $0 \leq a < 6$.

- a i** Find the Cartesian equation of the curve.
ii Find the intercepts of the curve with the x -axis.

b Define the function which represents the part of the curve above the x -axis.

c Differentiate $x\sqrt{9 - x^2}$.

- d i** Show that $\frac{x^2}{\sqrt{9 - x^2}}$ can be expressed in the form $\frac{A}{\sqrt{9 - x^2}} - \sqrt{9 - x^2}$ by finding the appropriate value for A .

ii Hence show that the result in **c** can be written as $2\sqrt{9 - x^2} - \frac{9}{\sqrt{9 - x^2}}$.

e Use this result and calculus to find an antiderivative of $\sqrt{9 - x^2}$.

f Hence find the area of the region enclosed by the curve above the x -axis.

g For $a = 0$, find the area of the region enclosed by the curve.

h For $a = 0$, find the volume of the solid of revolution formed when the curve is rotated about its horizontal axis.

- 16** A curve is defined by the parametric equations $x = t^2$ and $y = \frac{1}{3}t^3 - t$.

a The curve can be described by a Cartesian equation of the form $y^2 = g(x)$. Find $g(x)$.

b Find the coordinates of the stationary points of the curve.

c Find the area of a region enclosed by the curve.

d Find the volume of the solid formed by rotating this region around the x -axis.

- 17** A curve is defined by the parametric equations

$$x = \sin(t), \quad y = \sin(4t)$$

for $0 \leq t \leq 2\pi$. The graph is shown.

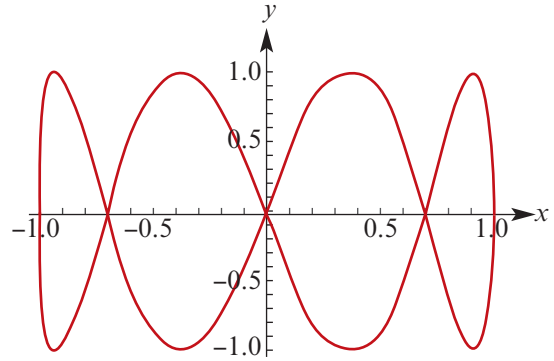

- a** Find the Cartesian equation of the curve with y in terms of x .
- b** Find $\frac{dx}{dt}$, $\frac{dy}{dt}$ and $\frac{dy}{dx}$ in terms of t .
- c**
- i** Find the values of t for which $\frac{dy}{dx} = 0$.
 - ii** Find the values of x for which $\frac{dy}{dx} = 0$.
 - iii** Find the coordinates of the stationary points of the graph.
 - iv** Find the gradients of the graph at $x = \frac{1}{\sqrt{2}}$, at $x = \frac{-1}{\sqrt{2}}$ and at the origin.
 - v** Show that the gradient is undefined when $x = -1$ or $x = 1$.
- d** Find the total area of the regions enclosed by the curve.
- e** Find the volume of the solid of revolution formed by rotating the curve around the x -axis.

- 18** The position of a particle at time t is given by

$$\mathbf{r}(t) = 5 \sin\left(\frac{\pi t}{30}\right) \mathbf{i} + 20 \sin\left(\frac{\pi t}{15}\right) \mathbf{j}$$

for $t \geq 0$.

- a** Find the Cartesian equation of the path of the particle. The curve is shown.
- b** Find the gradients of the curve when:
- i** $x = 0$
 - ii** $x = 3$
- c**
- i** Find the velocity of the particle when $t = 7.5$.
 - ii** Find the speed of the particle when $t = 7.5$.
- d** Find, using the method of substitution, the area of the regions enclosed by the curve.
- e** Find the greatest distance from the origin reached by the particle.
- f** Find the volume of the solid of revolution formed by rotating the curve around the x -axis.

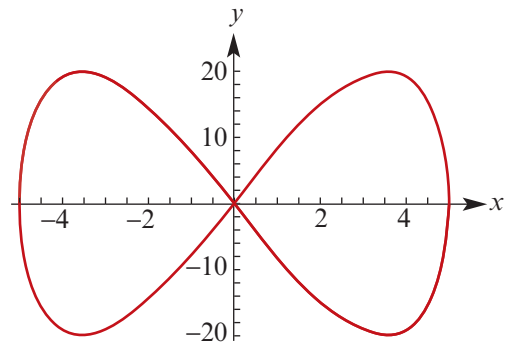

- 19** Let $f: \mathbb{R} \rightarrow \mathbb{R}$, $f(x) = \frac{x^3}{x^2 + a}$, where a is a positive real constant.
- Find $f'(x)$ and $f''(x)$.
 - Find the coordinates of the stationary point and state its nature.
 - Find the coordinates of the points of inflection (non-stationary).
 - Find the equation of the asymptote of the graph of f .
 - Sketch the graph of f .
 - Find the value of a such that the area between the curve, the line $y = x$ and the line $x = a$ is equal to $\frac{1}{2} \ln 2$.
- 20** Let $f: \mathbb{R} \rightarrow \mathbb{R}$, $f(x) = \frac{x^3}{x^2 - a}$, where a is a positive real constant.
- Find $f'(x)$ and $f''(x)$.
 - Find the coordinates of the stationary points of f in terms of a and state their nature.
 - Find the coordinates of the point of inflection of f .
 - Find the equations of the asymptotes of the graph of f .
 - Sketch the graph of f .
 - Find the value of a if a stationary point of f occurs where $x = 4\sqrt{3}$.
- 21** Let $f: [-1, 1] \rightarrow \mathbb{R}$, $f(x) = x \arcsin(x)$ and $g: [-1, 1] \rightarrow \mathbb{R}$, $g(x) = \arcsin(x)$.
- Find $f'(x)$ and the coordinates of any turning points for $x \in (-1, 1)$.
 - Find $f''(x)$ and show that there are no points of inflection for $x \in (-1, 1)$.
 - Prove that $f(x) \geq 0$ for all $x \in [-1, 1]$.
 - Find the values of x for which $f(x) = g(x)$.
 - Sketch the graphs of f and g on the one set of axes.
 - Find the area of the region enclosed by the graphs of f and g .
- 22** The coordinates, $P(x, y)$, of points on a curve satisfy the differential equations
- $$\frac{dx}{dt} = -3y \quad \text{and} \quad \frac{dy}{dt} = \sin(2t)$$
- and when $t = 0$, $y = -\frac{1}{2}$ and $x = 0$.
- Find x and y in terms of t .
 - Find the Cartesian equation of the curve.
 - Find the gradient of the tangent to the curve at a point $P(x, y)$ in terms of t .
 - Find the axis intercepts of the tangent in terms of t .
 - Let the x - and y -axis intercepts of the tangent be points A and B respectively, and let O be the origin. Find an expression for the area of triangle AOB in terms of t , and hence find the minimum area of this triangle and the values of t for which this occurs.
 - Give a pair of parametric equations in terms of t which describe the circle with centre the origin and the same x -axis intercepts as the curve.
 - Find the volume of the solid formed by rotating the region between the circle and the curve about the x -axis.

Glossary

A

Absolute value [p. 44] The absolute value (or *modulus*) of a real number x is defined by

$$|x| = \begin{cases} x & \text{if } x \geq 0 \\ -x & \text{if } x < 0 \end{cases}$$

Acceleration [p. 492] the rate of change of velocity with respect to time

Acceleration, average [p. 492]

$$\text{average acceleration} = \frac{\text{change in velocity}}{\text{change in time}}$$

Acceleration, instantaneous [pp. 492, 519]

$$a = \frac{dv}{dt} = \frac{d^2x}{dt^2} = v \frac{dv}{dx} = \frac{d}{dx} \left(\frac{1}{2} v^2 \right)$$

Addition of complex numbers [p. 230]

If $z_1 = a + bi$ and $z_2 = c + di$, then
 $z_1 + z_2 = (a + c) + (b + d)i$.

Addition of vectors [p. 121]

If $\mathbf{a} = a_1\mathbf{i} + a_2\mathbf{j} + a_3\mathbf{k}$ and $\mathbf{b} = b_1\mathbf{i} + b_2\mathbf{j} + b_3\mathbf{k}$, then $\mathbf{a} + \mathbf{b} = (a_1 + b_1)\mathbf{i} + (a_2 + b_2)\mathbf{j} + (a_3 + b_3)\mathbf{k}$.

Amplitude of circular functions [p. 4]

The distance between the mean position and the maximum position is called the amplitude.

The graph of $y = a \sin x$ has an amplitude of $|a|$.

Angle between two lines [p. 182] Let θ be the angle between two vectors \mathbf{d}_1 and \mathbf{d}_2 that are parallel to the two lines. The angle between the lines is θ or $180^\circ - \theta$, whichever is in $[0^\circ, 90^\circ]$.

Angle between two planes [p. 195] Let θ be the angle between two vectors \mathbf{n}_1 and \mathbf{n}_2 that are normal to the two planes. The angle between the planes is θ or $180^\circ - \theta$, whichever is in $[0^\circ, 90^\circ]$.

Angle between two vectors [p. 145] can be found using the scalar product:

$$\mathbf{a} \cdot \mathbf{b} = |\mathbf{a}||\mathbf{b}| \cos \theta$$

where θ is the angle between \mathbf{a} and \mathbf{b}

Angular velocity, ω [p. 589] the rate of change of angle with respect to time

Antiderivative [p. 346] To find the general antiderivative of $f(x)$: If $F'(x) = f(x)$, then

$$\int f(x) dx = F(x) + c$$

where c is an arbitrary real number.

Antiderivative of a vector function [p. 577]

If $\mathbf{r}(t) = x(t)\mathbf{i} + y(t)\mathbf{j} + z(t)\mathbf{k}$, then

$$\int \mathbf{r}(t) dt = X(t)\mathbf{i} + Y(t)\mathbf{j} + Z(t)\mathbf{k} + \mathbf{c}$$

where $\frac{dX}{dt} = x(t)$, $\frac{dY}{dt} = y(t)$, $\frac{dZ}{dt} = z(t)$

and \mathbf{c} is a constant vector.

Area of a parallelogram [p. 184] The area of the parallelogram spanned by two vectors \mathbf{a} and \mathbf{b} is given by $|\mathbf{a} \times \mathbf{b}|$.

Area of a region between two curves [p. 393]

$$\int_a^b f(x) dx - \int_a^b g(x) dx = \int_a^b f(x) - g(x) dx$$

where $f(x) \geq g(x)$ for all $x \in [a, b]$

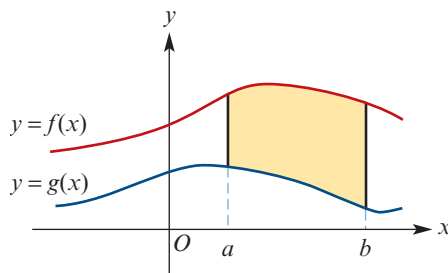

Argand diagram [p. 232] a geometric representation of the set of complex numbers

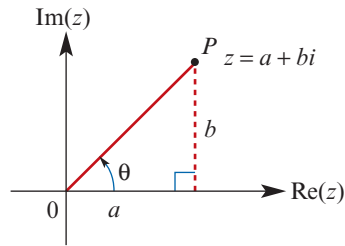

Argument of a complex number [pp. 241, 242]

- An argument of a non-zero complex number z is an angle θ from the positive direction of the x -axis to the line joining the origin to z .
- The *principal value* of the argument, denoted by $\text{Arg } z$, is the angle in the interval $(-\pi, \pi]$.

Argument, properties [pp. 247, 248]

- $\text{Arg}(z_1 z_2) = \text{Arg}(z_1) + \text{Arg}(z_2) + 2k\pi$, where $k = 0, 1$ or -1
- $\text{Arg}\left(\frac{z_1}{z_2}\right) = \text{Arg}(z_1) - \text{Arg}(z_2) + 2k\pi$, where $k = 0, 1$ or -1
- $\text{Arg}\left(\frac{1}{z}\right) = -\text{Arg}(z)$, provided z is not a negative real number

Augmented matrix [p. 214] represents a system of linear equations. For example:

$$\left[\begin{array}{ccc|c} 1 & 1 & 2 & 9 \\ 2 & 4 & -3 & 1 \\ 3 & 6 & -5 & 0 \end{array} \right] \quad \begin{array}{l} x + y + 2z = 9 \\ 2x + 4y - 3z = 1 \\ 3x + 6y - 5z = 0 \end{array}$$

Augmented matrix, row leader [p. 215] the first non-zero entry of a row

Augmented matrix, row operations [p. 214] operations that produce an equivalent system of equations (i.e. the solution set is the same):

- Interchange two rows.
- Multiply a row by a non-zero number.
- Add a multiple of one row to another row.

Augmented matrix, row-echelon form [p. 215]

Each successive row leader is further to the right, and so each row leader has only 0s below.

C

\mathbb{C} [p. 228] the set of complex numbers:

$$\mathbb{C} = \{a + bi : a, b \in \mathbb{R}\}$$

Cartesian equation An equation in variables x and y describes a curve in the plane by giving the relationship between the x - and y -coordinates of the points on the curve; e.g. $y = x^2 + 1$.

An equation in x , y and z describes a surface in three-dimensional space; e.g. $x^2 + y^2 + z^2 = 1$.

Cartesian form of a complex number [p. 232]

A complex number is expressed in Cartesian form as $z = a + bi$, where a is the real part of z and b is the imaginary part of z .

Central limit theorem [p. 693] Let X be any random variable, with mean μ and standard deviation σ . Then, provided that the sample size n is large enough, the distribution of the sample mean \bar{X} is approximately normal with mean $E(\bar{X}) = \mu$ and standard deviation $\text{sd}(\bar{X}) = \frac{\sigma}{\sqrt{n}}$.

Chain rule [p. 298]

- If $f(x) = h(g(x))$, then $f'(x) = h'(g(x))g'(x)$.
- If $y = h(u)$ and $u = g(x)$, then $\frac{dy}{dx} = \frac{dy}{du} \frac{du}{dx}$.

Change of variable rule [p. 357] *see* integration by substitution

Circle, general Cartesian equation [p. 19]

The circle with radius r and centre (h, k) has equation $(x - h)^2 + (y - k)^2 = r^2$.

Circular functions [p. 2] the sine, cosine and tangent functions

cis θ [p. 241] $\cos \theta + i \sin \theta$

Coefficient of friction, μ [pp. 616, 617]

a constant which determines the resistance to motion between two surfaces in contact

Collinear points [p. 151] Three or more points are collinear if they all lie on a single line.

Complex conjugate, \bar{z} [pp. 236, 242]

- If $z = a + bi$, then $\bar{z} = a - bi$.
- If $z = r \text{cis } \theta$, then $\bar{z} = r \text{cis}(-\theta)$.

Complex conjugate, properties [p. 237]

- $z + \bar{z} = 2 \text{Re}(z)$ ■ $z\bar{z} = |z|^2$
- $\overline{z_1 + z_2} = \bar{z}_1 + \bar{z}_2$ ■ $\overline{z_1 z_2} = \bar{z}_1 \bar{z}_2$

Complex number [p. 228] an expression of the form $a + bi$, where a and b are real numbers

Complex plane [p. 232] *see* Argand diagram

Composite function [p. 49] For functions f and g such that $\text{ran } f \subseteq \text{dom } g$, the composite function of g with f is defined by $g \circ f(x) = g(f(x))$, where $\text{dom}(g \circ f) = \text{dom } f$.

Compound angle formulas [p. 84]

- $\cos(x + y) = \cos x \cos y - \sin x \sin y$
- $\cos(x - y) = \cos x \cos y + \sin x \sin y$
- $\sin(x + y) = \sin x \cos y + \cos x \sin y$
- $\sin(x - y) = \sin x \cos y - \cos x \sin y$
- $\tan(x + y) = \frac{\tan x + \tan y}{1 - \tan x \tan y}$
- $\tan(x - y) = \frac{\tan x - \tan y}{1 + \tan x \tan y}$

Concavity [p. 302]

- If $f''(x) > 0$ for all $x \in (a, b)$, then the gradient of the curve is increasing over the interval; the curve is said to be *concave up*.
- If $f''(x) < 0$ for all $x \in (a, b)$, then the gradient of the curve is decreasing over the interval; the curve is said to be *concave down*.

Concurrent lines [p. 181] Three or more lines are concurrent if they all pass through a single point.

Confidence interval [p. 696] an interval estimate for the population mean μ based on the value of the sample mean \bar{x}

Conjugate root theorem [p. 257]

If a polynomial has real coefficients, then the complex roots occur in conjugate pairs.

Constant acceleration formulas [p. 503]

- $v = u + at$ ■ $s = ut + \frac{1}{2}at^2$
- $v^2 = u^2 + 2as$ ■ $s = \frac{1}{2}(u + v)t$

Cosecant function [p. 77] $\operatorname{cosec} \theta = \frac{1}{\sin \theta}$
for $\sin \theta \neq 0$

Cosine function [p. 2] cosine θ is defined as the x -coordinate of the point P on the unit circle where OP forms an angle of θ radians with the positive direction of the x -axis.

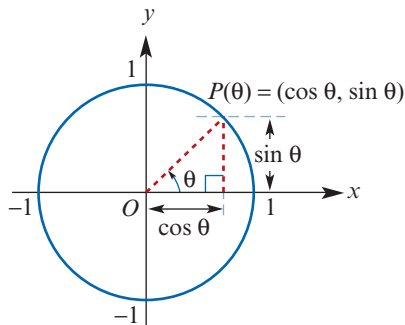
**Cosine rule** [p. 16] For triangle ABC :

$$a^2 = b^2 + c^2 - 2bc \cos A$$

or equivalently

$$\cos A = \frac{b^2 + c^2 - a^2}{2bc}$$

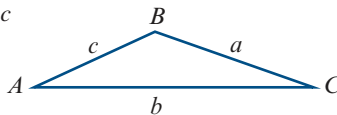

Cotangent function [p. 78] $\cot \theta = \frac{\cos \theta}{\sin \theta}$
for $\sin \theta \neq 0$

Cross product [p. 184] *see* vector product

D**De Moivre's theorem** [p. 249]

$$(r \operatorname{cis} \theta)^n = r^n \operatorname{cis}(n\theta), \text{ where } n \in \mathbb{Z}$$

Definite integral [pp. 347, 387] $\int_a^b f(x) dx$ denotes the signed area enclosed by the graph of $y = f(x)$ between $x = a$ and $x = b$.

Derivative function [p. 298] also called the gradient function. The derivative f' of a function f is given by

$$f'(x) = \lim_{h \rightarrow 0} \frac{f(x+h) - f(x)}{h}$$

Derivative of a vector function [p. 573]

$$\mathbf{r}(t) = x(t)\mathbf{i} + y(t)\mathbf{j} + z(t)\mathbf{k}$$

$$\dot{\mathbf{r}}(t) = \frac{dx}{dt}\mathbf{i} + \frac{dy}{dt}\mathbf{j} + \frac{dz}{dt}\mathbf{k}$$

$$\ddot{\mathbf{r}}(t) = \frac{d^2x}{dt^2}\mathbf{i} + \frac{d^2y}{dt^2}\mathbf{j} + \frac{d^2z}{dt^2}\mathbf{k}$$

Derivatives, basic [p. 298]

$f(x)$	$f'(x)$	$f(x)$	$f'(x)$
x^n	nx^{n-1}	$\sin(ax)$	$a \cos(ax)$
e^{ax}	ae^{ax}	$\cos(ax)$	$-a \sin(ax)$
$\ln ax $	$\frac{1}{x}$	$\tan(ax)$	$a \sec^2(ax)$

Derivatives, inverse circular [pp. 309–310]

$f(x)$	$f'(x)$
$\sin^{-1}\left(\frac{x}{a}\right)$	$\frac{1}{\sqrt{a^2 - x^2}}$
$\cos^{-1}\left(\frac{x}{a}\right)$	$\frac{-1}{\sqrt{a^2 - x^2}}$
$\tan^{-1}\left(\frac{x}{a}\right)$	$\frac{a}{a^2 + x^2}$

Differential equation [p. 430] an equation involving derivatives of a particular function or variable; e.g.

$$\frac{dy}{dx} = \cos x, \quad \frac{d^2y}{dx^2} - 4 \frac{dy}{dx} = 0, \quad \frac{dy}{dx} = \frac{y}{y+1}$$

Differential equation, general solution [p. 430]

$y = \sin x + c$ is the general solution of the

differential equation $\frac{dy}{dx} = \cos x$.

Differential equation, particular solution

[p. 430] $y = \sin x$ is the particular solution of the differential equation $\frac{dy}{dx} = \cos x$, given $y(0) = 0$.

Displacement [p. 488] The displacement of a particle moving in a straight line is defined as the change in position of the particle.

Distance from a point P to a line [p. 175]
given by $|\vec{PQ}|$, where Q is the point on the line such that PQ is perpendicular to the line

Distance from a point P to a plane [p. 193]
given by $|\vec{PQ} \cdot \hat{n}|$, where \hat{n} is a unit vector normal to the plane and Q is any point on the plane

Division of complex numbers [pp. 238, 248]

$$\frac{z_1}{z_2} = \frac{z_1}{z_2} \times \frac{\bar{z}_2}{\bar{z}_2} = \frac{z_1 \bar{z}_2}{|z_2|^2}$$

If $z_1 = r_1 \operatorname{cis} \theta_1$ and $z_2 = r_2 \operatorname{cis} \theta_2$, then

$$\frac{z_1}{z_2} = \frac{r_1}{r_2} \operatorname{cis}(\theta_1 - \theta_2)$$

Dot product [p. 143] *see* scalar product

Double angle formulas [p. 86]

$$\begin{aligned} \blacksquare \cos(2x) &= \cos^2 x - \sin^2 x \\ &= 1 - 2\sin^2 x \\ &= 2\cos^2 x - 1 \end{aligned}$$

$$\blacksquare \sin(2x) = 2 \sin x \cos x$$

$$\blacksquare \tan(2x) = \frac{2 \tan x}{1 - \tan^2 x}$$

E

Ellipse [p. 21] The graph of the equation

$$\frac{(x-h)^2}{a^2} + \frac{(y-k)^2}{b^2} = 1$$

is an ellipse centred at the point (h, k) .

Equality of complex numbers [p. 230]

$a + bi = c + di$ if and only if $a = c$ and $b = d$

Equilibrium [p. 634] A particle is said to be in equilibrium if the resultant force acting on it is zero; the particle will remain at rest or continue moving with constant velocity.

Equivalence of vectors [p. 131]

Let $\mathbf{a} = a_1\mathbf{i} + a_2\mathbf{j} + a_3\mathbf{k}$ and $\mathbf{b} = b_1\mathbf{i} + b_2\mathbf{j} + b_3\mathbf{k}$.

If $\mathbf{a} = \mathbf{b}$, then $a_1 = b_1$, $a_2 = b_2$ and $a_3 = b_3$.

Euler's formula [p. 470]

If $\frac{dy}{dx} = g(x)$ with $x_0 = a$ and $y_0 = b$, then

$$x_{n+1} = x_n + h \quad \text{and} \quad y_{n+1} = y_n + hg(x_n)$$

Euler's method [p. 469] a numerical method for solving differential equations using linear approximations

Expected value of a random variable, $E(X)$ [p. 669] also called the mean, μ .

For a discrete random variable X :

$$E(X) = \sum_x x \cdot \Pr(X = x)$$

For a continuous random variable X :

$$E(X) = \int_{-\infty}^{\infty} xf(x) dx$$

Exponential distribution [p. 414] For $\lambda > 0$, an exponential random variable X with parameter λ has a probability density function given by

$$f(x) = \begin{cases} \lambda e^{-\lambda x} & \text{if } x \geq 0 \\ 0 & \text{otherwise} \end{cases}$$

The mean and standard deviation of X are given by

$$E(X) = \frac{1}{\lambda} \quad \text{and} \quad \operatorname{sd}(X) = \frac{1}{\lambda}$$

F

Factor theorem [p. 256] Let $\alpha \in \mathbb{C}$. Then $z - \alpha$ is a factor of a polynomial $P(z)$ if and only if $P(\alpha) = 0$.

Force [p. 602] causes a change in motion; e.g. gravitational force, tension force, normal reaction force. Force is a vector quantity.

Friction [p. 616] The magnitude of the frictional force on a particle moving on a surface is

$$F_R = \mu R$$

where R is the magnitude of the normal reaction force and μ is the coefficient of friction.

Fundamental theorem of algebra [p. 260]

Every non-constant polynomial with complex coefficients has at least one linear factor in the complex number system.

Fundamental theorem of calculus [p. 387] If f is a continuous function on an interval $[a, b]$, then

$$\int_a^b f(x) dx = F(b) - F(a)$$

where F is any antiderivative of f and $\int_a^b f(x) dx$ is the definite integral from a to b .

G

g [p. 611] the acceleration of a particle due to gravity. Close to the Earth's surface, the value of g is approximately 9.8 m/s^2 .

Gradient function *see* derivative function

H

Horizontal-line test [p. 54] If a horizontal line can be drawn anywhere on the graph of a function and it only ever intersects the graph a maximum of once, then the function is *one-to-one*.

Hyperbola [p. 24] The graph of the equation

$$\frac{(x-h)^2}{a^2} - \frac{(y-k)^2}{b^2} = 1$$

is a hyperbola centred at the point (h, k) ; the asymptotes are given by

$$y - k = \pm \frac{b}{a}(x - h)$$

I

Imaginary number i [p. 228] $i^2 = -1$

Imaginary part of a complex number [p. 228]

If $z = a + bi$, then $\text{Im}(z) = b$.

Implicit differentiation [p. 330] used to find the gradient at a point on a curve such as $x^2 + y^2 = 1$, which is not defined by a rule of the form $y = f(x)$ or $x = f(y)$

Integrals, standard [pp. 347, 354]

$f(x)$	$\int f(x) dx$
$(ax + b)^n$	$\frac{1}{a(n+1)}(ax + b)^{n+1} + c$
$\frac{1}{ax + b}$	$\frac{1}{a} \ln ax + b + c$
e^{ax+b}	$\frac{1}{a}e^{ax+b} + c$
$\sin(ax + b)$	$-\frac{1}{a} \cos(ax + b) + c$
$\cos(ax + b)$	$\frac{1}{a} \sin(ax + b) + c$
$\frac{1}{\sqrt{a^2 - x^2}}$	$\sin^{-1}\left(\frac{x}{a}\right) + c$
$\frac{-1}{\sqrt{a^2 - x^2}}$	$\cos^{-1}\left(\frac{x}{a}\right) + c$
$\frac{a}{a^2 + x^2}$	$\tan^{-1}\left(\frac{x}{a}\right) + c$

Integration by parts [p. 375]

$$\int u \frac{dv}{dx} dx = uv - \int v \frac{du}{dx} dx$$

Integration by substitution [p. 357]

$$\int f(u) \frac{du}{dx} dx = \int f(u) du$$

Inverse cosine function (arccos) [p. 90]

$\cos^{-1}: [-1, 1] \rightarrow \mathbb{R}$, $\cos^{-1} x = y$,
where $\cos y = x$ and $y \in [0, \pi]$

Inverse function [p. 55] For a one-to-one function f , the inverse function f^{-1} is defined by $f^{-1}(x) = y$ if $f(y) = x$, for $x \in \text{ran } f$, $y \in \text{dom } f$.

Inverse sine function (arcsin) [p. 89]

$\sin^{-1}: [-1, 1] \rightarrow \mathbb{R}$, $\sin^{-1} x = y$,

where $\sin y = x$ and $y \in \left[-\frac{\pi}{2}, \frac{\pi}{2}\right]$

Inverse tangent function (arctan) [p. 90]

$\tan^{-1}: \mathbb{R} \rightarrow \mathbb{R}$, $\tan^{-1} x = y$,

where $\tan y = x$ and $y \in \left(-\frac{\pi}{2}, \frac{\pi}{2}\right)$

K

Kilogram weight, kg wt [p. 602] a unit of force.

If an object on the surface of the Earth has a mass of 1 kg, then the gravitational force acting on this object is 1 kg wt.

L

Lami's theorem [p. 636] can be used to simplify a problem involving three forces acting on a particle in equilibrium:

$$\frac{P}{\sin p^\circ} = \frac{Q}{\sin q^\circ} = \frac{R}{\sin r^\circ}$$

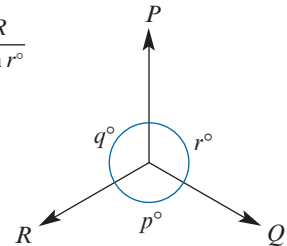

Limits of integration [p. 347] In the expression $\int_a^b f(x) dx$, the number a is called the *lower limit* of integration and b the *upper limit* of integration.

Line in three dimensions [pp. 171, 173] can be described as follows, where $\mathbf{a} = a_1\mathbf{i} + a_2\mathbf{j} + a_3\mathbf{k}$ is the position vector of a point A on the line, and $\mathbf{d} = d_1\mathbf{i} + d_2\mathbf{j} + d_3\mathbf{k}$ is parallel to the line:

Vector equation	$\mathbf{r} = \mathbf{a} + t\mathbf{d}$, $t \in \mathbb{R}$
Parametric equations	$x = a_1 + d_1t$ $y = a_2 + d_2t$ $z = a_3 + d_3t$
Cartesian form	$\frac{x - a_1}{d_1} = \frac{y - a_2}{d_2} = \frac{z - a_3}{d_3}$

Linear approximation formula [p. 469]

$$f(x + h) \approx f(x) + hf'(x)$$

Linear combination of independent normal random variables [p. 676] If X and Y are independent normal random variables,

then $aX + bY$ is also a normal random variable (provided a and b are not both zero).

Linear combination of random variables

[p. 673]

- $E(aX + bY) = aE(X) + bE(Y)$
- $\text{Var}(aX + bY) = a^2\text{Var}(X) + b^2\text{Var}(Y)$ if X and Y are independent

Linear combination of vectors [p. 126] A vector \mathbf{w} is a linear combination of vectors $\mathbf{v}_1, \mathbf{v}_2, \dots, \mathbf{v}_n$ if it can be expressed in the form

$$\mathbf{w} = k_1\mathbf{v}_1 + k_2\mathbf{v}_2 + \dots + k_n\mathbf{v}_n$$

where k_1, k_2, \dots, k_n are real numbers.

Linear dependence [p. 126]

- A set of vectors is linearly dependent if at least one of its members can be expressed as a linear combination of other vectors in the set.
- Vectors \mathbf{a} , \mathbf{b} and \mathbf{c} are linearly dependent if there exist real numbers k , ℓ and m , not all zero, such that $k\mathbf{a} + \ell\mathbf{b} + m\mathbf{c} = \mathbf{0}$.

Linear equation [p. 206] an equation of the form $a_1x_1 + a_2x_2 + \dots + a_nx_n = b$, where x_1, x_2, \dots, x_n are variables and a_1, a_2, \dots, a_n, b are constants.

- **Two variables** An equation $ax + by = c$ represents a line in two-dimensional space (provided a and b are not both zero).
- **Three variables** An equation $ax + by + cz = d$ represents a plane in three-dimensional space (provided a, b and c are not all zero).

Linear function of a random variable [p. 668]

- $E(aX + b) = aE(X) + b$
- $\text{Var}(aX + b) = a^2\text{Var}(X)$

Linear independence [p. 126]

- A set of vectors is linearly independent if no vector in the set is expressible as a linear combination of other vectors in the set.
- Vectors \mathbf{a} , \mathbf{b} and \mathbf{c} are linearly independent if $k\mathbf{a} + \ell\mathbf{b} + m\mathbf{c} = \mathbf{0}$ implies $k = \ell = m = 0$.

Locus [p. 266] a set of points described by a geometric condition; e.g. the locus of the equation $|z - 1 - i| = 2$ is the circle with centre $1 + i$ and radius 2

Logistic differential equation [p. 456]

$$\frac{dP}{dt} = rP \left(1 - \frac{P}{K}\right), \quad 0 < P < K$$

This differential equation can be used to model a population P at time t , where:

- the constant r is called the *growth parameter*
- the constant K is called the *carrying capacity*.

M

Magnitude of a vector [p. 120] the length of a directed line segment corresponding to the vector.

- If $\mathbf{u} = x\mathbf{i} + y\mathbf{j}$, then $|\mathbf{u}| = \sqrt{x^2 + y^2}$.
- If $\mathbf{u} = x\mathbf{i} + y\mathbf{j} + z\mathbf{k}$, then $|\mathbf{u}| = \sqrt{x^2 + y^2 + z^2}$.

Many-to-one function [p. 54] a function that is not one-to-one

Margin of error, M [p. 700] the distance between the sample estimate and the endpoints of the confidence interval

Mass [p. 602] The mass of an object is the amount of matter it contains, and can be measured in kilograms. Mass is not the same as weight.

Mean of a random variable, μ [p. 669]

see expected value of a random variable, $E(X)$

Modulus function [p. 44] The modulus (or *absolute value*) of a real number x is defined by

$$|x| = \begin{cases} x & \text{if } x \geq 0 \\ -x & \text{if } x < 0 \end{cases}$$

Modulus of a complex number, $|z|$ [pp. 236, 241] the distance of the complex number from the origin. If $z = a + bi$, then $|z| = \sqrt{a^2 + b^2}$.

Modulus, properties [p. 236]

For complex numbers z_1 and z_2 :

- $|z_1z_2| = |z_1||z_2|$ (the modulus of a product is the product of the moduli)
- $\left|\frac{z_1}{z_2}\right| = \frac{|z_1|}{|z_2|}$ (the modulus of a quotient is the quotient of the moduli)

Modulus–argument form of a complex number

[p. 241] see polar form of a complex number

Momentum [p. 612] The momentum of a particle is the product of its mass and velocity: $\mathbf{P} = m\mathbf{v}$. Momentum can be considered as the fundamental quantity of motion.

Multiplication of a complex number by a real number [pp. 231, 246]

- If $z = a + bi$ and $k \in \mathbb{R}$, then $kz = ka + kbi$.
- If $z = r \text{ cis } \theta$ and $k > 0$, then $kz = kr \text{ cis } \theta$.
- If $z = r \text{ cis } \theta$ and $k < 0$, then $kz = |k|r \text{ cis } (\theta + \pi)$.

Multiplication of a complex number by i

[pp. 234, 247] corresponds to a rotation about the origin by 90° anticlockwise. If $z = a + bi$, then $iz = i(a + bi) = -b + ai$.

Multiplication of a vector by a scalar

[p. 121] If $\mathbf{a} = a_1\mathbf{i} + a_2\mathbf{j} + a_3\mathbf{k}$ and $m \in \mathbb{R}$, then $m\mathbf{a} = ma_1\mathbf{i} + ma_2\mathbf{j} + ma_3\mathbf{k}$.

Multiplication of complex numbers [pp. 234,

247] If $z_1 = a + bi$ and $z_2 = c + di$, then

$$z_1z_2 = (ac - bd) + (ad + bc)i$$

If $z_1 = r_1 \text{ cis } \theta_1$ and $z_2 = r_2 \text{ cis } \theta_2$, then

$$z_1z_2 = r_1r_2 \text{ cis } (\theta_1 + \theta_2)$$

N

Newton, N [p. 602] the standard unit of force.

$$1 \text{ N} = 1 \text{ kg m/s}^2$$

Newton's first law of motion [p. 613] If the resultant force on a particle is zero, then the particle will remain stationary or in uniform straight-line motion.

Newton's law of cooling [p. 444] The rate at which a body cools is proportional to the difference between its temperature and the temperature of its immediate surroundings.

Newton's second law of motion [p. 613]

$$F = ma$$

The rate of change of momentum of a particle at any instant is proportional to the resultant force on the particle.

Newton's third law of motion [p. 613] If an object A exerts a force on another object B (*action*), then B exerts a force on A of equal magnitude but opposite direction (*reaction*).

Normal distribution [p. 679] a symmetric, bell-shaped distribution that often occurs for a measure in a population (e.g. height, weight, IQ); its centre is determined by the mean, μ , and its width by the standard deviation, σ .

Normal reaction force [p. 615] A mass placed on a surface (horizontal or inclined) experiences a force perpendicular to the surface, called the normal reaction force.

Normal vector to a plane [p. 188] a vector that is perpendicular to the plane

O

One-to-one function [p. 53] different x -values map to different y -values. For example, the function $y = x + 1$ is one-to-one. But $y = x^2$ is not one-to-one, as both 2 and -2 map to 4.

P

Parametric equations [p. 28] A pair of equations of the form $x = f(t)$ and $y = g(t)$ describes a curve in the plane, where t is called the *parameter* of the curve. For example:

- **Circle** $x = a \cos t$ and $y = a \sin t$
- **Ellipse** $x = a \cos t$ and $y = b \sin t$
- **Hyperbola** $x = a \sec t$ and $y = b \tan t$

Similarly, equations $x = f(t)$, $y = g(t)$ and $z = h(t)$ describe a curve in three-dimensional space.

Partial fractions [p. 367] Some rational functions may be expressed as a sum of partial fractions; e.g.

$$\frac{A}{ax+b} + \frac{B}{cx+d} + \frac{C}{(cx+d)^2} + \frac{Dx+E}{ex^2+fx+g}$$

Particle model [p. 602] an object is considered as a point. This can be done when the size of the object can be neglected in comparison with other lengths in the problem being considered, or when rotational motion effects can be ignored.

Period of a function [p. 4] A function f with domain \mathbb{R} is periodic if there is a positive constant a such that $f(x+a) = f(x)$ for all x . The smallest such a is called the period of f .

- Sine and cosine have period 2π .
- Tangent has period π .
- A function of the form $y = a \cos(nx + \varepsilon) + b$ or $y = a \sin(nx + \varepsilon) + b$ has period $\frac{2\pi}{n}$.

Plane in three dimensions [p. 188] can be described as follows, where \mathbf{a} is the position vector of a point A on the plane, $\mathbf{n} = n_1\mathbf{i} + n_2\mathbf{j} + n_3\mathbf{k}$ is normal to the plane, and $k = \mathbf{a} \cdot \mathbf{n}$:

$$\text{Vector equation} \quad \mathbf{r} \cdot \mathbf{n} = \mathbf{a} \cdot \mathbf{n}$$

$$\text{Cartesian equation} \quad n_1x + n_2y + n_3z = k$$

Point estimate [p. 696] If the value of the sample mean \bar{x} is used as an estimate of the population mean μ , then it is called a point estimate of μ .

Point of inflection [p. 302] a point where a curve changes from concave up to concave down or from concave down to concave up. That is, a point of inflection occurs where the sign of the second derivative changes.

Polar form of a complex number [p. 241]

A complex number is expressed in polar form as $z = r \operatorname{cis} \theta$, where r is the modulus of z and θ is an argument of z . This is also called *modulus–argument form*.

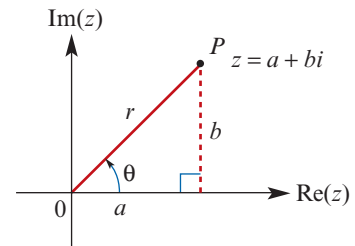

Population [p. 678] the set of all eligible members of a group which we intend to study

Population mean, μ [p. 678] the mean of all values of a measure in the entire population

Population parameter [p. 678] a statistical measure that is based on the whole population; the value is constant for a given population

Position [p. 488] For a particle moving in a straight line, the position of the particle relative to a point O on the line is determined by its distance from O and whether it is to the right or left of O . The direction to the right of O is positive.

Position vector [p. 123] A position vector, \vec{OP} , indicates the position in space of the point P relative to the origin O .

Product rule [p. 298]

- If $f(x) = g(x)h(x)$, then
 $f'(x) = g'(x)h(x) + g(x)h'(x)$.
- If $y = uv$, then $\frac{dy}{dx} = u \frac{dv}{dx} + v \frac{du}{dx}$.

Pythagorean identity [pp. 6, 81]

$$\begin{aligned}\cos^2 \theta + \sin^2 \theta &= 1 \\ 1 + \tan^2 \theta &= \sec^2 \theta \\ \cot^2 \theta + 1 &= \operatorname{cosec}^2 \theta\end{aligned}$$

Q

Quadratic formula [p. 254] An equation of the form $az^2 + bz + c = 0$, with $a \neq 0$, may be solved using the quadratic formula:

$$z = \frac{-b \pm \sqrt{b^2 - 4ac}}{2a}$$

Quotient rule [p. 298]

- If $f(x) = \frac{g(x)}{h(x)}$, then
 $f'(x) = \frac{g'(x)h(x) - g(x)h'(x)}{(h(x))^2}$.
- If $y = \frac{u}{v}$, then $\frac{dy}{dx} = \frac{v \frac{du}{dx} - u \frac{dv}{dx}}{v^2}$.

R

Radian [p. 3] One radian (written 1°) is the angle subtended at the centre of the unit circle by an arc of length 1 unit.

Radioactive decay [p. 444] The rate at which a radioactive substance decays is proportional to the mass of the substance remaining.

Rational function [p. 321] a function of the form

$$f(x) = \frac{g(x)}{h(x)}, \text{ where } g(x) \text{ and } h(x) \text{ are polynomials}$$

Real part of a complex number [p. 228]

If $z = a + bi$, then $\operatorname{Re}(z) = a$.

Reciprocal circular functions [p. 77]

the cosecant, secant and cotangent functions

Reciprocal function [p. 325] The reciprocal of the function $y = f(x)$ is defined by $y = \frac{1}{f(x)}$.

Reciprocal functions, properties [p. 325]

- The x -axis intercepts of the original function determine the equations of the asymptotes for the reciprocal function.
- The reciprocal of a positive number is positive.
- The reciprocal of a negative number is negative.

- A graph and its reciprocal will intersect at a point if the y -coordinate is 1 or -1 .
- Local maximums of the original function produce local minimums of the reciprocal.
- Local minimums of the original function produce local maximums of the reciprocal.
- If $g(x) = \frac{1}{f(x)}$, then $g'(x) = -\frac{f'(x)}{(f(x))^2}$.
Therefore, at any given point, the gradient of the reciprocal function is opposite in sign to that of the original function.

Remainder theorem [p. 256] Let $\alpha \in \mathbb{C}$. When a polynomial $P(z)$ is divided by $z - \alpha$, the remainder is $P(\alpha)$.

Restricted cosine function [p. 90]

$$f: [0, \pi] \rightarrow \mathbb{R}, f(x) = \cos x$$

Restricted sine function [p. 89]

$$f: \left[-\frac{\pi}{2}, \frac{\pi}{2}\right] \rightarrow \mathbb{R}, f(x) = \sin x$$

Restricted tangent function [p. 90]

$$f: \left(-\frac{\pi}{2}, \frac{\pi}{2}\right) \rightarrow \mathbb{R}, f(x) = \tan x$$

Resultant force [p. 603] the vector sum of the forces acting at a point

Roots of a complex number [p. 264]

The n th roots of a complex number a are the solutions of the equation $z^n = a$. If $a = 1$, then the solutions are called the *n th roots of unity*.

S

Sample [p. 678] a subset of the population which we select in order to make inferences about the whole population

Sample mean, \bar{x} [p. 678] the mean of all values of a measure in a particular sample. The values \bar{x} are the values of a random variable \bar{X} .

Sample statistic [p. 678] a statistical measure that is based on a sample from the population; the value varies from sample to sample

Sampling distribution [p. 678] the distribution of a statistic which is calculated from a sample

Scalar product [p. 143] The scalar product of two vectors $\mathbf{a} = a_1\mathbf{i} + a_2\mathbf{j} + a_3\mathbf{k}$ and $\mathbf{b} = b_1\mathbf{i} + b_2\mathbf{j} + b_3\mathbf{k}$ is given by

$$\mathbf{a} \cdot \mathbf{b} = a_1b_1 + a_2b_2 + a_3b_3$$

Scalar product, properties [p. 144]

- $\mathbf{a} \cdot \mathbf{b} = \mathbf{b} \cdot \mathbf{a}$ ■ $k(\mathbf{a} \cdot \mathbf{b}) = (k\mathbf{a}) \cdot \mathbf{b} = \mathbf{a} \cdot (k\mathbf{b})$
- $\mathbf{a} \cdot \mathbf{0} = 0$ ■ $\mathbf{a} \cdot (\mathbf{b} + \mathbf{c}) = \mathbf{a} \cdot \mathbf{b} + \mathbf{a} \cdot \mathbf{c}$
- $\mathbf{a} \cdot \mathbf{a} = |\mathbf{a}|^2$

Scalar quantity [p. 602] a quantity determined only by its magnitude; e.g. distance, time, mass

Scalar resolute [p. 148] The scalar resolute of \mathbf{a} in the direction of \mathbf{b} is given by $\mathbf{a} \cdot \hat{\mathbf{b}} = \frac{\mathbf{a} \cdot \mathbf{b}}{|\mathbf{b}|}$.

Secant function [p. 77] $\sec \theta = \frac{1}{\cos \theta}$
for $\cos \theta \neq 0$

Second derivative [p. 302]

- The second derivative of a function f with rule $f(x)$ is denoted by f'' and has rule $f''(x)$.
- The second derivative of y with respect to x is denoted by $\frac{d^2y}{dx^2}$.

Separation of variables [p. 458]

If $\frac{dy}{dx} = f(x)g(y)$, then $\int f(x) dx = \int \frac{1}{g(y)} dy$.

Signed area [p. 387] The signed area of the shaded region is $A_1 - A_2 + A_3 - A_4$.

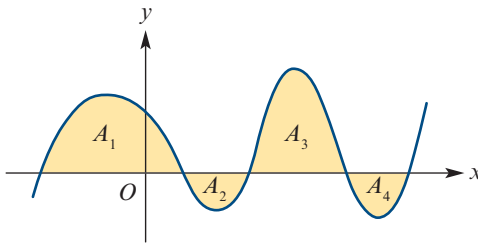

Simple harmonic motion [p. 524] motion in a straight line such that $\ddot{x} = -n^2(x - c)$, for constants n and c with $n > 0$. The particle oscillates about the centre point $x = c$.

Simulation [p. 678] using technology (calculators or computers) to repeat a random process many times; e.g. random sampling

Sine function [p. 2] $\sin \theta$ is defined as the y -coordinate of the point P on the unit circle where OP forms an angle of θ radians with the positive direction of the x -axis.

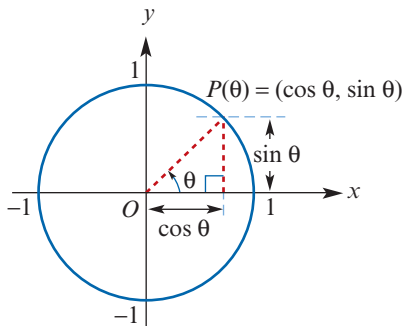

Sine rule [p. 14] For triangle ABC :

$$\frac{a}{\sin A} = \frac{b}{\sin B} = \frac{c}{\sin C}$$

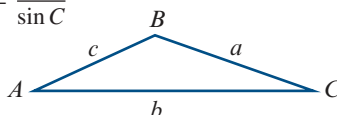

Skew lines [p. 180] In three-dimensional space, two lines are skew if they do not intersect and are not parallel.

Sliding friction [p. 616] *see* friction

Slope field [p. 475]

The slope field of a differential equation

$$\frac{dy}{dx} = f(x, y)$$

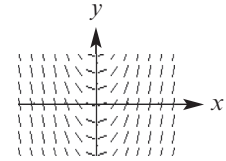

assigns to each point $P(x, y)$ in the plane the number $f(x, y)$, which is the gradient of the solution curve through P .

Solid of revolution [p. 408] the solid formed by rotating a region about a line

Speed [p. 489] the magnitude of velocity

Speed, average [p. 489]

$$\text{average speed} = \frac{\text{total distance travelled}}{\text{total time taken}}$$

Sphere, general Cartesian equation [p. 200]

The sphere with radius a and centre (h, k, ℓ) has equation $(x - h)^2 + (y - k)^2 + (z - \ell)^2 = a^2$.

Sphere, general vector equation [p. 200]

The sphere with radius a and centre C has vector equation $|\mathbf{r} - \vec{OC}| = a$.

Standard deviation of a random variable, σ

a measure of the spread or variability, given by

$$\text{sd}(X) = \sqrt{\text{Var}(X)}$$

Standard deviation of a sample, s

a measure of the spread or variability of a sample about the sample mean \bar{x} , given by

$$s = \sqrt{\frac{1}{n-1} \sum_{i=1}^n (x_i - \bar{x})^2}$$

Subtraction of complex numbers [p. 230]

If $z_1 = a + bi$ and $z_2 = c + di$, then

$$z_1 - z_2 = (a - c) + (b - d)i.$$

Subtraction of vectors [p. 122]

If $\mathbf{a} = a_1\mathbf{i} + a_2\mathbf{j} + a_3\mathbf{k}$ and $\mathbf{b} = b_1\mathbf{i} + b_2\mathbf{j} + b_3\mathbf{k}$, then $\mathbf{a} - \mathbf{b} = (a_1 - b_1)\mathbf{i} + (a_2 - b_2)\mathbf{j} + (a_3 - b_3)\mathbf{k}$.

System of linear equations [pp. 207, 210, 213]

a finite set of linear equations that are to be solved simultaneously

T

Tangent function [p. 2] $\tan \theta = \frac{\sin \theta}{\cos \theta}$

for $\cos \theta \neq 0$

U

Unit vector [p. 131] a vector of magnitude 1. The unit vectors in the positive directions of the x -, y - and z -axes are \mathbf{i} , \mathbf{j} and \mathbf{k} respectively. The unit vector in the direction of \mathbf{a} is given by

$$\hat{\mathbf{a}} = \frac{1}{|\mathbf{a}|} \mathbf{a}$$

V

Variance of a random variable, σ^2 [p. 670] a measure of the spread or variability, defined by $\text{Var}(X) = E[(X - \mu)^2]$

An alternative (computational) formula is $\text{Var}(X) = E(X^2) - [E(X)]^2$

Vector [p. 120] a set of equivalent directed line segments

Vector function [p. 563] If $\mathbf{r}(t) = x(t)\mathbf{i} + y(t)\mathbf{j}$, then we say that \mathbf{r} is a vector function of t .

Vector product, formula [p. 185]

For $\mathbf{a} = a_1\mathbf{i} + a_2\mathbf{j} + a_3\mathbf{k}$ and $\mathbf{b} = b_1\mathbf{i} + b_2\mathbf{j} + b_3\mathbf{k}$, the vector product $\mathbf{a} \times \mathbf{b}$ is given by $(a_2b_3 - a_3b_2)\mathbf{i} - (a_1b_3 - a_3b_1)\mathbf{j} + (a_1b_2 - a_2b_1)\mathbf{k}$

Vector product, geometric properties [p. 184]

- **Magnitude** $|\mathbf{a} \times \mathbf{b}| = |\mathbf{a}||\mathbf{b}| \sin \theta$, where θ is the angle between vectors \mathbf{a} and \mathbf{b}
- **Direction** $\mathbf{a} \times \mathbf{b}$ is perpendicular to both \mathbf{a} and \mathbf{b} (if \mathbf{a} and \mathbf{b} are non-parallel non-zero vectors)

Vector product, properties [pp. 184, 185]

- $k(\mathbf{a} \times \mathbf{b}) = (k\mathbf{a}) \times \mathbf{b} = \mathbf{a} \times (k\mathbf{b})$
- $\mathbf{a} \times (\mathbf{b} + \mathbf{c}) = \mathbf{a} \times \mathbf{b} + \mathbf{a} \times \mathbf{c}$
- $\mathbf{b} \times \mathbf{a} = -(\mathbf{a} \times \mathbf{b})$ ■ $\mathbf{a} \times \mathbf{a} = \mathbf{a} \times \mathbf{0} = \mathbf{0}$

Vector quantity [p. 602] a quantity determined by its magnitude and direction; e.g. force, velocity

Vector resolute [p. 148] The vector resolute of \mathbf{a} in the direction of \mathbf{b} is given by

$$\frac{\mathbf{a} \cdot \mathbf{b}}{\mathbf{b} \cdot \mathbf{b}} \mathbf{b} = (\mathbf{a} \cdot \hat{\mathbf{b}}) \hat{\mathbf{b}}$$

Vectors, parallel [p. 123] Two non-zero vectors \mathbf{a} and \mathbf{b} are parallel if and only if $\mathbf{a} = k\mathbf{b}$ for some $k \in \mathbb{R} \setminus \{0\}$.

Vectors, perpendicular [p. 144] Two non-zero vectors \mathbf{a} and \mathbf{b} are perpendicular if and only if $\mathbf{a} \cdot \mathbf{b} = 0$.

Vectors, properties [p. 124]

- $\mathbf{a} + \mathbf{b} = \mathbf{b} + \mathbf{a}$ commutative law
- $(\mathbf{a} + \mathbf{b}) + \mathbf{c} = \mathbf{a} + (\mathbf{b} + \mathbf{c})$ associative law
- $\mathbf{a} + \mathbf{0} = \mathbf{a}$ zero vector
- $\mathbf{a} + (-\mathbf{a}) = \mathbf{0}$ additive inverse
- $m(\mathbf{a} + \mathbf{b}) = m\mathbf{a} + m\mathbf{b}$ distributive law

Vectors, resolution [p. 148] A vector \mathbf{a} is resolved into rectangular components by writing it as a sum of two vectors, one parallel to a given vector \mathbf{b} and the other perpendicular to \mathbf{b} .

Velocity [p. 489] the rate of change of position with respect to time

Velocity, average [p. 489]

$$\text{average velocity} = \frac{\text{change in position}}{\text{change in time}}$$

Velocity, instantaneous [p. 489] $v = \frac{dx}{dt}$

Velocity–time graph [p. 508]

- Acceleration is given by the gradient.
- Displacement is given by the signed area bounded by the graph and the t -axis.
- Distance travelled is given by the total area bounded by the graph and the t -axis.

Volume of a solid of revolution [p. 408]

■ **Rotation about the x -axis**

If the region is bounded by the curve $y = f(x)$, the lines $x = a$ and $x = b$ and the x -axis, then $V = \int_a^b \pi y^2 dx = \pi \int_a^b (f(x))^2 dx$

■ **Rotation about the y -axis**

If the region is bounded by the curve $x = f(y)$, the lines $y = a$ and $y = b$ and the y -axis, then $V = \int_a^b \pi x^2 dy = \pi \int_a^b (f(y))^2 dy$

■ **Region not bounded by the x -axis**

If the shaded region is rotated about the x -axis, then the volume V is given by $V = \pi \int_a^b (f(x))^2 - (g(x))^2 dx$

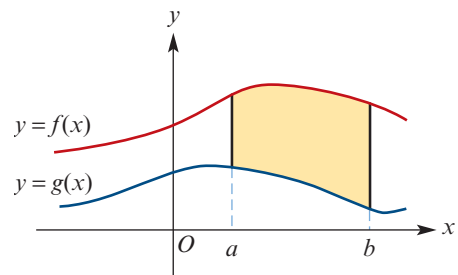

W

Weight [p. 611] On the Earth's surface, a mass of m kg has a force of m kg wt (or mg newtons) acting on it; this force is known as the weight.

Z

Zero vector, $\mathbf{0}$ [p. 122] a line segment of zero length with no direction

Answers

Chapter 1

Exercise 1A

- 1 a i 4π ii 3π iii $-\frac{5\pi}{2}$
 iv $\frac{\pi}{12}$ v $-\frac{\pi}{18}$ vi $-\frac{7\pi}{4}$
 b i 225° ii -120° iii 105°
 iv -330° v 260° vi -165°
 2 a i 0.12° ii -1.75° iii -0.44°
 iv 0.89° v 3.60° vi -7.16°
 b i 97.40° ii -49.85° iii 160.43°
 iv 5.73° v -171.89° vi -509.93°
 3 a $\frac{1}{\sqrt{2}}$ b $\frac{1}{2}$ c $\frac{\sqrt{3}}{2}$
 d $-\frac{1}{2}$ e $\frac{1}{\sqrt{2}}$ f $\frac{\sqrt{3}}{2}$
 4 a $\frac{\sqrt{3}}{2}$ b $-\frac{1}{\sqrt{2}}$ c $\frac{1}{2}$
 d $-\frac{1}{\sqrt{2}}$ e $\frac{1}{\sqrt{2}}$ f $-\frac{\sqrt{3}}{2}$
 g $-\frac{\sqrt{3}}{2}$ h $-\frac{\sqrt{3}}{2}$ i $\frac{1}{2}$
 5 a $-\frac{\sqrt{3}}{2}$ b $-\frac{1}{\sqrt{3}}$
 6 a $-\frac{\sqrt{51}}{10}$ b $\frac{\sqrt{51}}{7}$
 7 a $-\frac{\sqrt{3}}{2}$ b $\frac{1}{\sqrt{3}}$
 8 a $\frac{\sqrt{91}}{10}$ b $-\frac{3\sqrt{91}}{91}$
 9 $2\pi - a, 2\pi - b, 2\pi - c, 2\pi - d$

- 10 a $\frac{4\pi}{3}, \frac{5\pi}{3}$ b $\frac{2\pi}{3}, \frac{5\pi}{6}, \frac{5\pi}{3}, \frac{11\pi}{6}$
 c $\frac{\pi}{3}, \frac{2\pi}{3}, \frac{4\pi}{3}, \frac{5\pi}{3}$ d $\frac{5\pi}{6}, \frac{3\pi}{2}$
 e $0, \frac{\pi}{3}, \pi, \frac{4\pi}{3}, 2\pi$ f $\frac{\pi}{2}, \frac{2\pi}{3}, \frac{3\pi}{2}, \frac{5\pi}{3}$

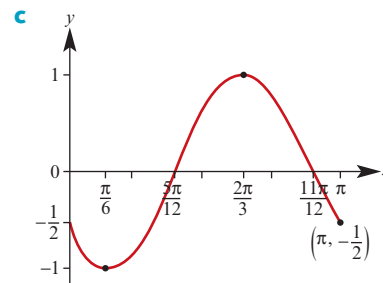
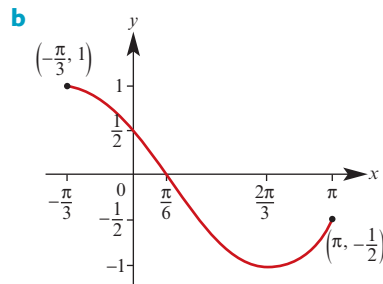
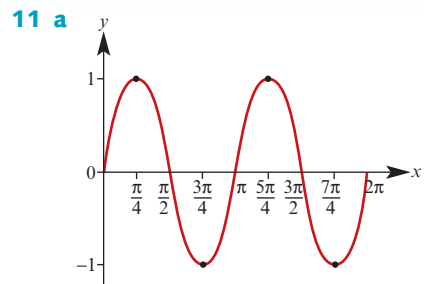

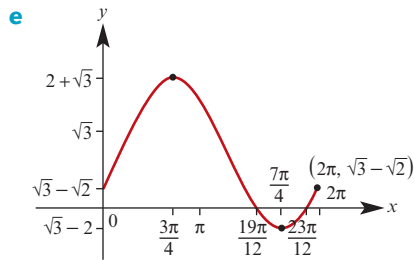
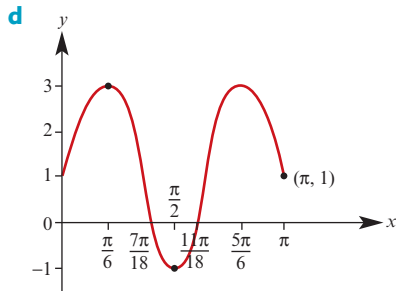

- 12 a** 1 **b** $\sqrt{3}$ **c** $\frac{1}{\sqrt{3}}$ **d** $\sqrt{3}$
- 13 a** $\frac{-\sqrt{17}}{17}$ **b** $\frac{-4\sqrt{17}}{17}$ **c** $\frac{-1}{4}$ **d** $\frac{-1}{4}$
- 14 a** $\frac{\sqrt{21}}{7}$ **b** $\frac{-2\sqrt{7}}{7}$ **c** $\frac{\sqrt{3}}{2}$ **d** $\frac{-\sqrt{3}}{2}$
- 15 a** $\frac{2\pi}{3}, \frac{5\pi}{3}$ **b** $\frac{\pi}{9}, \frac{4\pi}{9}, \frac{7\pi}{9}, \frac{10\pi}{9}, \frac{13\pi}{9}, \frac{16\pi}{9}$
- c** $\frac{3\pi}{2}$ **d** $\frac{\pi}{8}, \frac{5\pi}{8}, \frac{9\pi}{8}, \frac{13\pi}{8}$

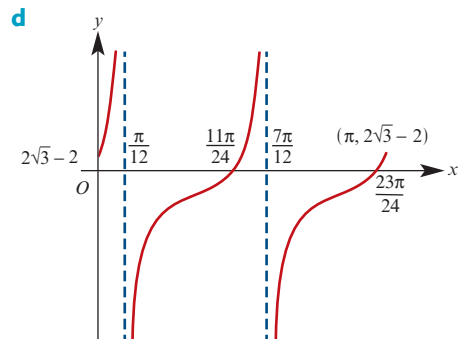
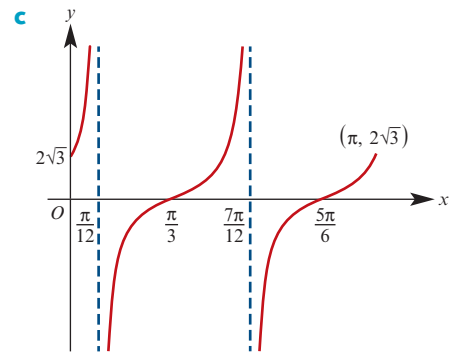
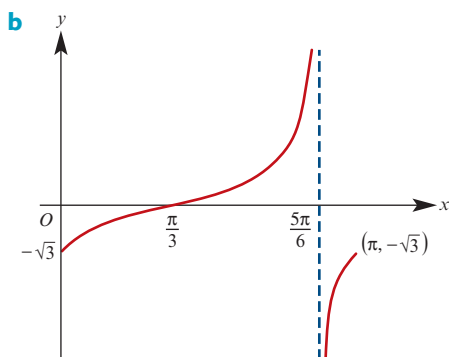
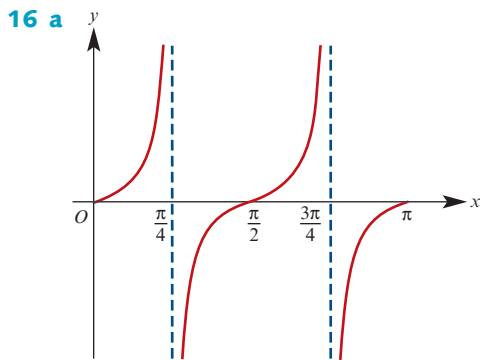

Exercise 1B

- 1 a** 11.67 cm **b** 9.62 cm
- 2 a** 58.08°, 121.92° **b** 10.01 cm, 4.09 cm
- 3 a** 7.15 cm **b** 50.43°
- 4 a** 54.90° **b** 100.95°
- 5** 16.71 cm
- 6 a** 6.71 cm
b 121.33° (acute angle is inconsistent)
- 7** $6\sqrt{6}$ cm **8** $\sqrt{7}$ cm
- 9** 30.10 cm **10** $5\sqrt{3} \pm \sqrt{39}$

Exercise 1C

- 1 a** $(x-2)^2 + (y-3)^2 = 1$
b $(x+3)^2 + (y-4)^2 = 25$
c $x^2 + (y+5)^2 = 25$
d $(x-3)^2 + y^2 = 2$
- 2 a** Centre $(-2, 3)$; radius 1
b Centre $(1, 2)$; radius 2
c Centre $(\frac{3}{2}, 0)$; radius $\frac{3}{2}$
d Centre $(-2, 5)$; radius 2
- 3 a** $(x + \frac{1}{4})^2 + (y + \frac{1}{4})^2 = \frac{1}{8}$

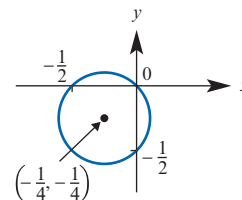

b $(x + \frac{3}{2})^2 + (y - 2)^2 = \frac{49}{4}$

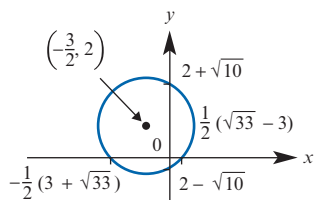

c $(x + 4)^2 + (y - 5)^2 = 25$

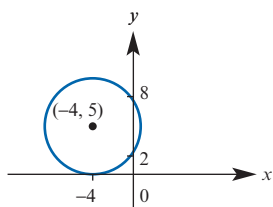

d $(x - 4)^2 + (y - 5)^2 = 25$

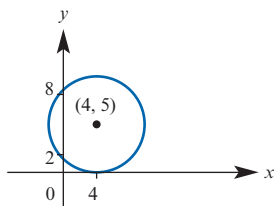

e $(x - 2)^2 + (y + \frac{5}{4})^2 = \frac{9}{16}$

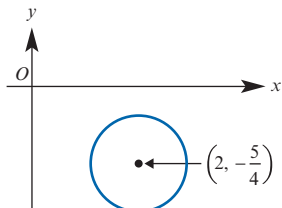

f $(x + 1)^2 + (y - \frac{3}{2})^2 = \frac{439}{12}$

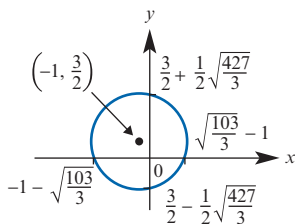

4 a $x^2 + y^2 \leq 16$

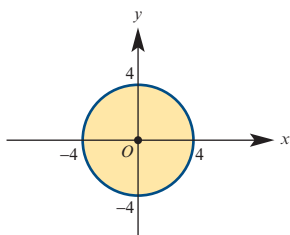

b $x^2 + y^2 \geq 9$

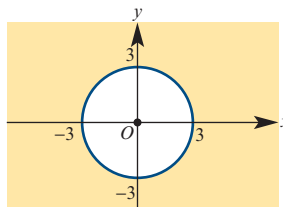

c $(x - 2)^2 + (y - 2)^2 < 4$

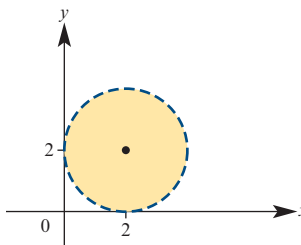

d $(x - 3)^2 + (y + 2)^2 > 16$

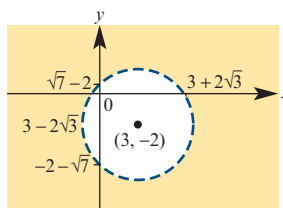

e $x^2 + y^2 \leq 16$ and $x \leq 2$

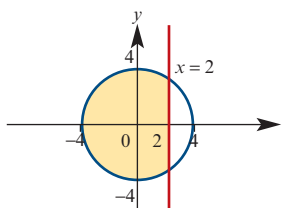

f $x^2 + y^2 \leq 9$ and $y \geq -1$

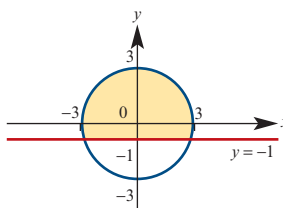

5 Centre (5, 3); radius $\sqrt{10}$

6 $(x - 2)^2 + (y + 3)^2 = 9$

7 $(x - 5)^2 + (y - 4)^2 = 13$

8 a First circle: centre $(\frac{15}{2}, \frac{19}{2})$; radius $\frac{5\sqrt{2}}{2}$
Second circle: centre (5, 7); radius 5

b (5, 12) and (10, 7)

9 a $(\frac{5\sqrt{2}}{2}, \frac{5\sqrt{2}}{2}), (\frac{-5\sqrt{2}}{2}, \frac{-5\sqrt{2}}{2})$

b $(\sqrt{5}, 2\sqrt{5}), (-\sqrt{5}, -2\sqrt{5})$

Exercise 1D

1 a $\frac{x^2}{9} + \frac{y^2}{16} = 1$, centre (0, 0)

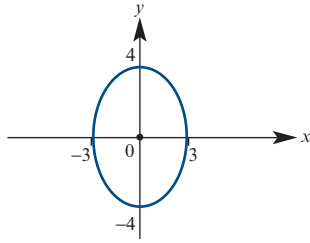

b $\frac{x^2}{16} + \frac{y^2}{25} = 1$, centre (0, 0)

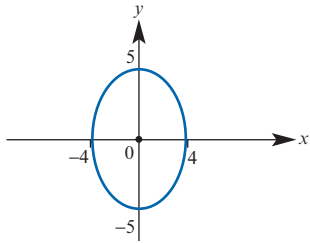

c $\frac{(x-4)^2}{9} + \frac{(y-1)^2}{16} = 1$, centre (4, 1)

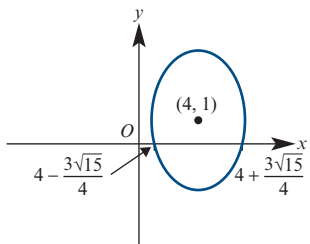

d $x^2 + \frac{(y-2)^2}{9} = 1$, centre (0, 2)

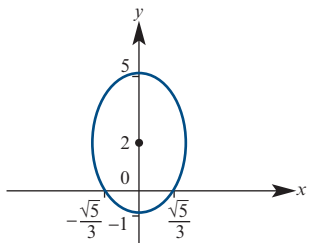

e $\frac{(x-3)^2}{25} + \frac{(y-2)^2}{9} = 1$, centre (3, 2)

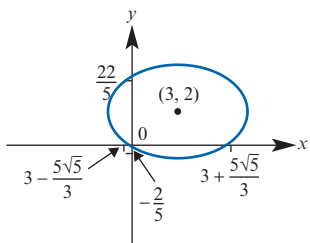

f $\frac{x^2}{25} + \frac{y^2}{9} = 1$, centre (0, 0)

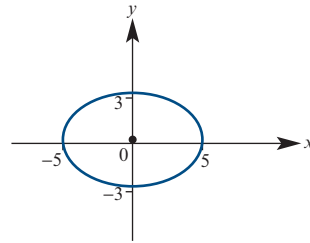

g $\frac{(x+2)^2}{9} + \frac{(y-1)^2}{5} = 1$, centre (-2, 1)

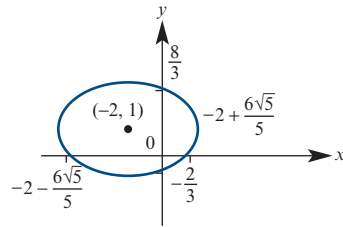

h $\frac{(x-1)^2}{25} + \frac{(y+2)^2}{16} = 1$, centre (1, -2)

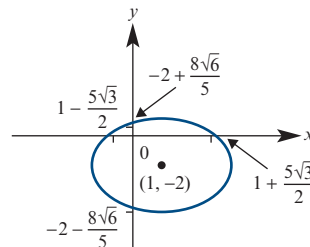

i $\frac{(x-2)^2}{4} + \frac{(y-3)^2}{9} = 1$, centre (2, 3)

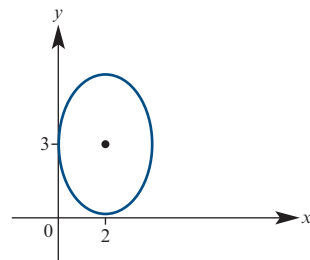

j $\frac{(x-2)^2}{8} + \frac{(y-1)^2}{4} = 1$, centre (2, 1)

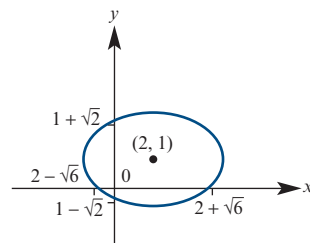

2 a $\frac{x^2}{16} - \frac{y^2}{9} = 1$, asymptotes $y = \pm \frac{3}{4}x$

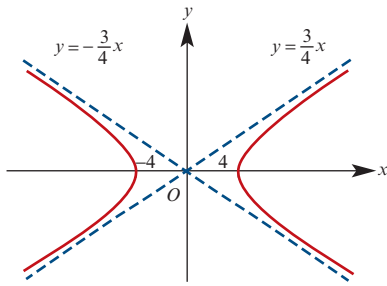

b $\frac{y^2}{16} - \frac{x^2}{9} = 1$, asymptotes $y = \pm \frac{4}{3}x$

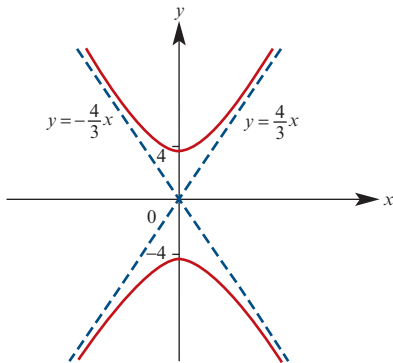

c $\frac{x^2}{4} - \frac{y^2}{4} = 1$, asymptotes $y = \pm x$

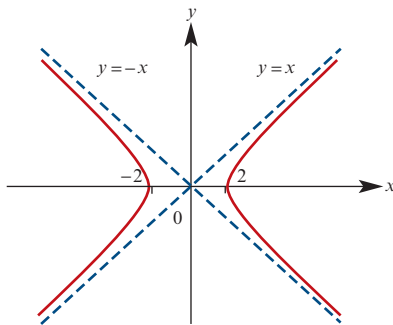

d $\frac{x^2}{2} - \frac{y^2}{4} = 1$, asymptotes $y = \pm \sqrt{2}x$

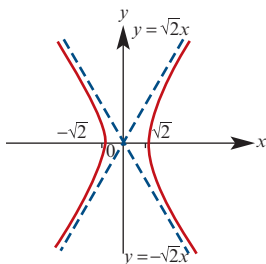

e $\frac{(x-2)^2}{16} - \frac{(y+1)^2}{4} = 1$,
asymptotes $y = \frac{1}{2}x - 2$, $y = -\frac{1}{2}x$

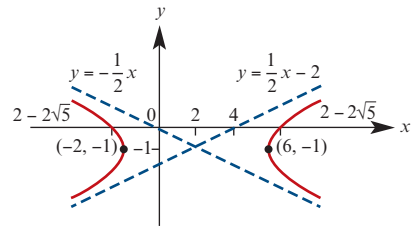

f $\frac{(x-5)^2}{25} - \frac{(y-3)^2}{9} = 1$,
asymptotes $y = \frac{3}{5}x$, $y = 6 - \frac{3}{5}x$

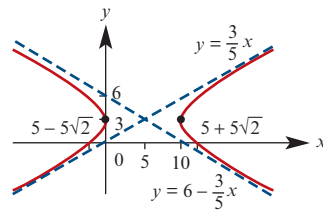

g $\frac{(x-2)^2}{4} - \frac{(y-3)^2}{9} = 1$,
asymptotes $y = \frac{3}{2}x$, $y = 6 - \frac{3}{2}x$

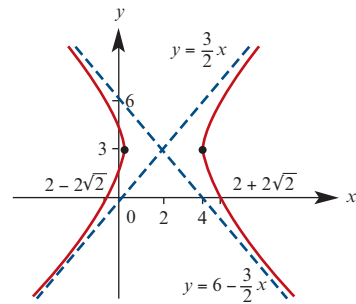

h $\frac{4(x-1)^2}{3} - \frac{(y-1)^2}{3} = 1$,
asymptotes $y = 2x - 1$, $y = 3 - 2x$

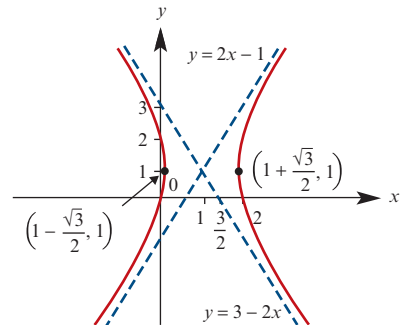

i $\frac{(x-1)^2}{16} - \frac{(y-1)^2}{9} = 1$,
 asymptotes $y = \frac{3}{4}x + \frac{1}{4}$, $y = \frac{7}{4} - \frac{3}{4}x$

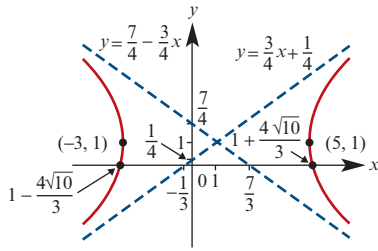

j $\frac{x^2}{16} - \frac{y^2}{25} = 1$, asymptotes $y = \pm \frac{5}{4}x$

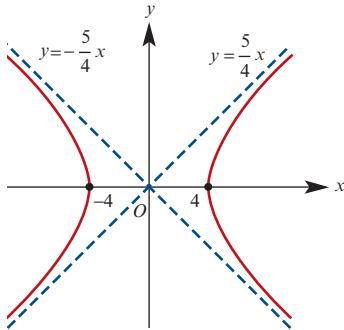

3 a $(\frac{2\sqrt{3}}{3}, \frac{\sqrt{3}}{3}), (-\frac{2\sqrt{3}}{3}, -\frac{\sqrt{3}}{3})$

b $(\sqrt{2}, \frac{\sqrt{2}}{2}), (-\sqrt{2}, -\frac{\sqrt{2}}{2})$

5 $(\frac{-6\sqrt{13}}{13}, \frac{-6\sqrt{13}}{13}), (\frac{6\sqrt{13}}{13}, \frac{6\sqrt{13}}{13}),$
 $(\frac{-6\sqrt{13}}{13}, \frac{6\sqrt{13}}{13}), (\frac{6\sqrt{13}}{13}, \frac{-6\sqrt{13}}{13})$

6 $(-2\sqrt{2}, -\frac{5\sqrt{2}}{2}), (2\sqrt{2}, \frac{5\sqrt{2}}{2})$

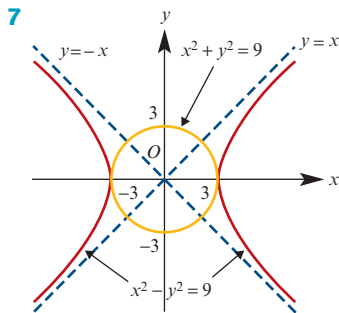

Exercise 1E

1 $x^2 + y^2 = 4$, dom = $[-2, 2]$, ran = $[-2, 2]$

2 a $y^2 = 16x$ **b** $x = 4$ **c** $32\sqrt{2}$

3 $\frac{(x-2)^2}{9} + \frac{(y-3)^2}{4} = 1$;
 ellipse with centre (2, 3)

4 $\frac{x^2}{4} - \frac{y^2}{9} = 1, x \leq -2$;

left branch of hyperbola with centre (0, 0) and x-axis intercept $(-2, 0)$; asymptotes $y = \pm \frac{3x}{2}$

5 a $x^2 + y^2 = 16$

b $x^2 + y^2 = 4$

c $\frac{x^2}{16} + \frac{y^2}{9} = 1$

d $\frac{x^2}{16} + \frac{y^2}{9} = 1$

e $\frac{y^2}{9} - \frac{x^2}{4} = 1$

f $y = x^2 - 2x - 3$

g $y = \frac{1}{x-2}$

h $y = x + 2$

i $\frac{y^2}{16} - \frac{x^2}{4} = 1$

6 a $x^2 - y^2 = 1, x \in (-\infty, -1]$

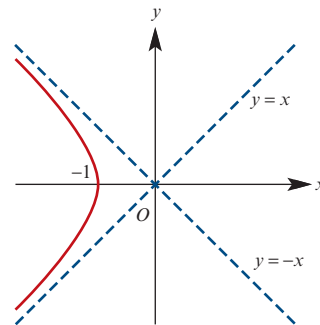

b $\frac{x^2}{9} + \frac{y^2}{16} = 1$

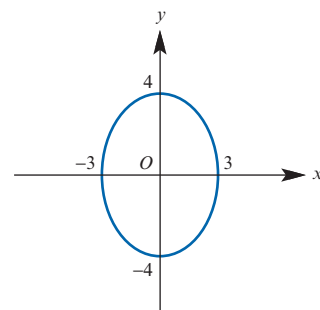

c $\frac{(x-3)^2}{9} + \frac{(y-2)^2}{4} = 1$

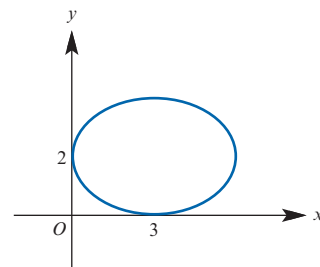

d $\frac{x^2}{9} + \frac{y^2}{16} = 1, x \in [-3, 3], y \in [0, 4]$

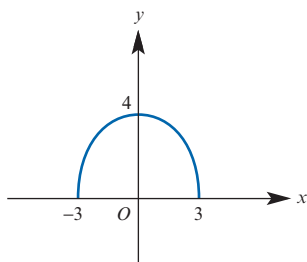

e $x^2 - y^2 = 1, x \in [1, \infty)$

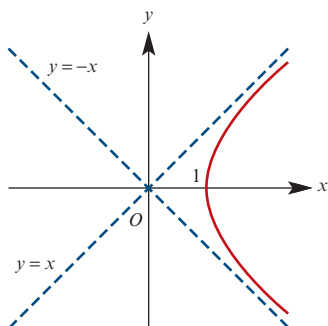

f $(x - 1)^2 - (y - 1)^2 = 1, x \in [2, \infty)$

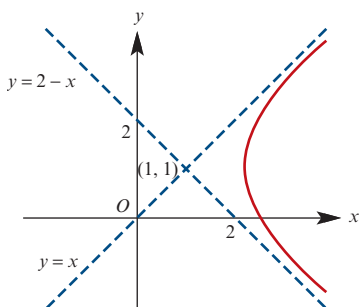

7 a $P = (-1, -\sqrt{3})$

b $\sqrt{3}x + 3y = -4\sqrt{3}$

8 a $x = 4 \cos t$ $y = 4 \sin t$

b $x = 3 \sec t$ $y = 2 \tan t$

c $x = 3 \cos t + 1$ $y = 3 \sin t - 2$

d $x = 9 \cos t + 1$ $y = 6 \sin t - 3$

9 $a = 1, b = 2, c = 3, d = 2$

10 $x = 4 \cos t, y = 3 \sin t$

11 a $x = 2 \cos t, y = 6 \sin t$

b $\frac{x^2}{4} + \frac{y^2}{36} = 1$

12 a $x = -2 \cos\left(\frac{t}{2}\right), y = 2 + 3 \sin\left(\frac{t}{2}\right)$

b $\frac{x^2}{4} + \frac{(y-2)^2}{9} = 1$

13 a dom = [2, 5], ran = [4, 6]

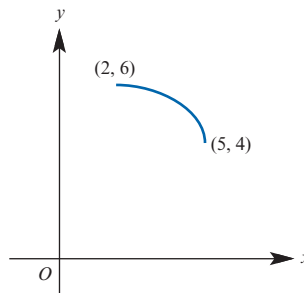

b dom = [2, 5], ran = [2, 6]

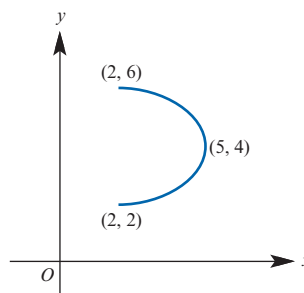

c dom = [-1, 5], ran = [2, 6]

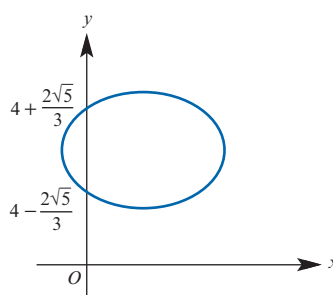

Chapter 1 review

Short-answer questions

1 a $\frac{7}{\sqrt{113}}$ **b** $\frac{9}{2}$

2 a $\frac{1}{\sqrt{2}}$ **b** $-\frac{4}{5}$ **c** 210° is a possible answer

3 $\frac{(x+2)^2}{4} + \frac{(y-3)^2}{16} = 1$

4 $\tan^{-1}(3\sqrt{2})$

5 a $\left\{-\frac{2\pi}{3}, -\frac{\pi}{3}, \frac{\pi}{3}, \frac{2\pi}{3}\right\}$

b

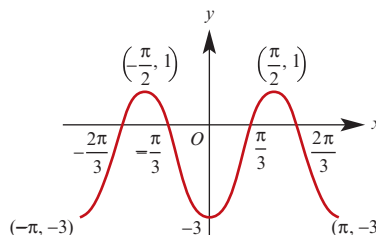

c $\left[-\pi, -\frac{2\pi}{3}\right) \cup \left(-\frac{\pi}{3}, \frac{\pi}{3}\right) \cup \left(\frac{2\pi}{3}, \pi\right]$

6 a $3\sqrt{97}$ nautical miles b $5\sqrt{97}$ nautical miles

7 $9\sqrt{2}$

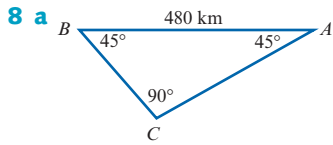

b $240\sqrt{2}$ km c $480\sqrt{2}$ km

9 $y = 3x + 2, y = -3x + 2$

10 $\frac{(x-4)^2}{9} + (y+6)^2 = 1$

11 $x^2 + (y-4)^2 = 4$

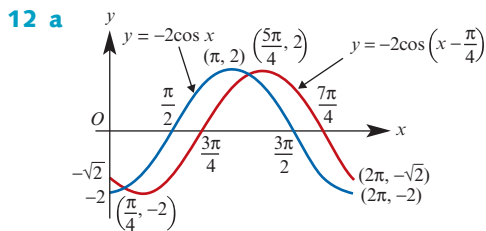

b $\left\{\frac{3\pi}{4}, \frac{7\pi}{4}\right\}$ c $\left[0, \frac{\pi}{2}\right] \cup \left[\frac{3\pi}{2}, 2\pi\right]$

13 a $\frac{\pi}{6}, \frac{5\pi}{6}$ b $\frac{\pi}{6}, \frac{11\pi}{6}$ c $\frac{\pi}{4}, \frac{5\pi}{4}$

14 $a = 1, c = 2, b = d = 3$

15 Centre $(-4, 6)$, radius 7

16 $(\pm 9, 0), (0, \pm 3)$

Multiple-choice questions

1 C 2 A 3 C 4 C 5 A

6 D 7 D 8 D

Extended-response questions

1 a $a = \sqrt{2}, w = \frac{3 - \sqrt{3}}{2}, x = \frac{1 + \sqrt{3}}{2}$,

$y = \frac{\sqrt{3} - 1}{2}, z = 15$

b $\sin 15^\circ = \frac{\sqrt{6} - \sqrt{2}}{4}, \cos 15^\circ = \frac{\sqrt{2} + \sqrt{6}}{4}$,

$\tan 15^\circ = 2 - \sqrt{3}$

c $\sin 75^\circ = \frac{\sqrt{2} + \sqrt{6}}{4}, \cos 75^\circ = \frac{\sqrt{6} - \sqrt{2}}{4}$,

$\tan 75^\circ = \frac{1}{2 - \sqrt{3}} = 2 + \sqrt{3}$

2 a 10.2 km

b 049°

c i 11.08 km ii 031°

d 11.93 km

3 a i $[-\sqrt{2}, \sqrt{2}]$ ii $[-3 - \sqrt{5}, -3 + \sqrt{5}]$
iii $(0, -3)$

b 2, 3, 1, 2 c $\left(\frac{37}{13}, \frac{11}{13}\right)$ d $\left(0, \frac{48}{13}\right)$

e $\left(x - \frac{1}{2}\right)^2 + \left(y - \frac{35}{26}\right)^2 = \frac{3890}{676}$

4 d Centre $(2, 2)$ and radius 2; centre $(10, 10)$ and radius 10

e Gradient undefined; gradient $\frac{3}{4}$

f $y = 4; y = -\frac{4}{3}x + \frac{20}{3}$

5 a $y = (\tan t)x$

b $(-a \cos t, -a \sin t)$

c $y - a \sin t = -\frac{\cos t}{\sin t}(x - a \cos t)$

d $A\left(\frac{a}{\cos t}, 0\right), B\left(0, \frac{a}{\sin t}\right)$

e Area = $\frac{a^2}{2 \sin t \cos t} = \frac{a^2}{\sin(2t)}$;

Minimum when $t = \frac{\pi}{4}$

6 Area = $\frac{L^2 \sin \alpha \sin \beta \sin \gamma}{2(\sin \alpha + \sin \beta + \sin \gamma)^2}$

Chapter 2

Exercise 2A

1 a 8 b 8 c 2 d -2 e -2 f 4

2 a 3, -1 b $\frac{7}{2}, -\frac{1}{2}$ c $\frac{12}{5}, -\frac{6}{5}$ d 12, -6

e -1, 7 f $\frac{4}{3}, -4$ g $-\frac{2}{5}, -4$

3 a $(-3, 3)$

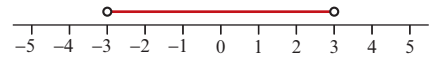

b $(-\infty, -5] \cup [5, \infty)$

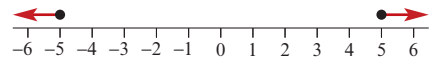

c $[1, 3]$

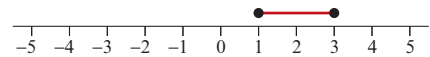

d $(-1, 5)$

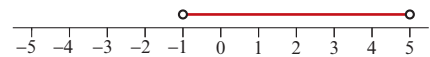

e $(-\infty, -8] \cup [2, \infty)$

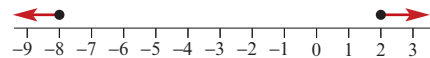

f $[-3, -1]$

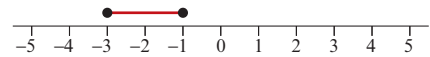

4 a Range $[1, \infty)$

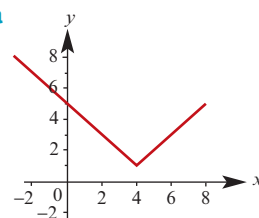

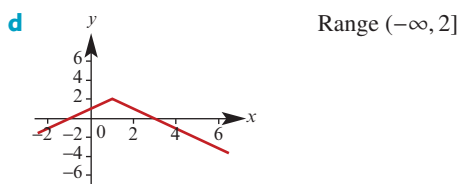
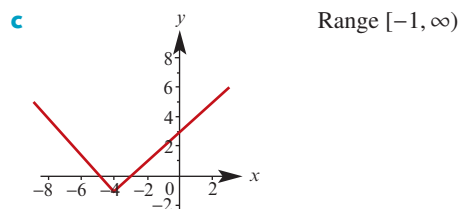
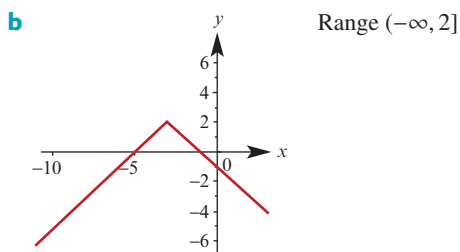

- 5 a** $\{x : -5 \leq x \leq 5\}$
b $\{x : x \leq -2\} \cup \{x : x \geq 2\}$
c $\{x : 1 \leq x \leq 2\}$ **d** $\{x : -\frac{1}{5} < x < 1\}$
e $\{x : x \leq -4\} \cup \{x : x \geq 10\}$
f $\{x : 1 \leq x \leq 3\}$
- 6 a** $x \leq -2$ **b** $x = -9$ or $x = 11$
c $x = -\frac{5}{4}$ or $x = \frac{15}{4}$

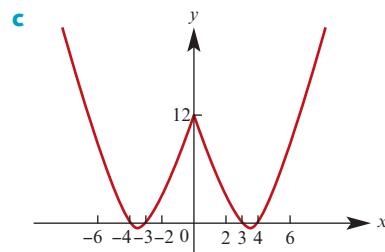
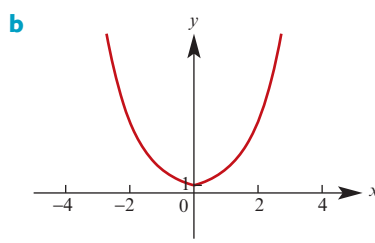
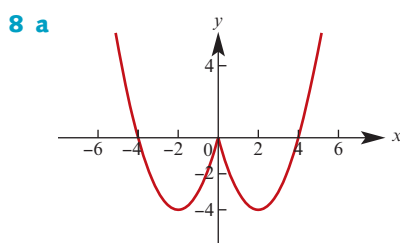
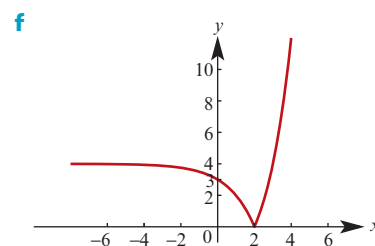
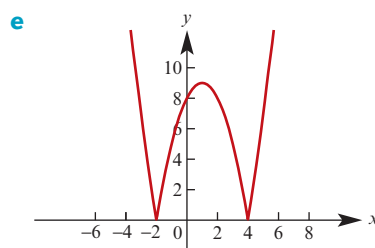
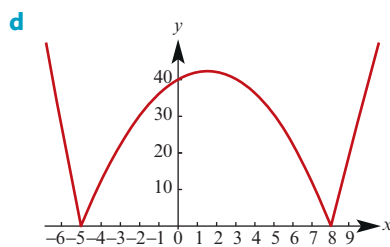
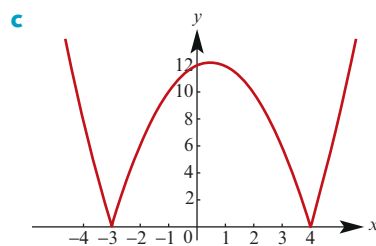
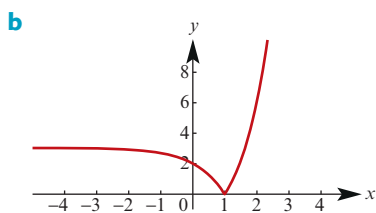
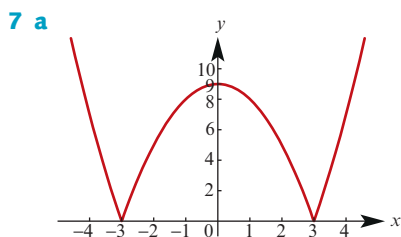

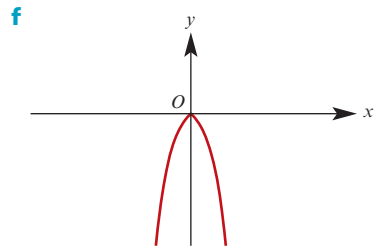
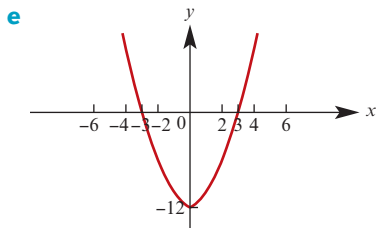
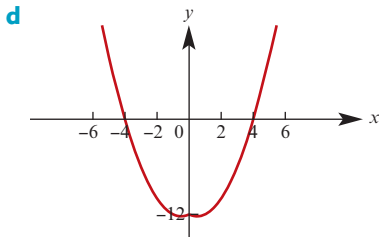

9 $a = 1, b = 1$

Exercise 2B

- 1 a** $f(g(x)) = 4x - 1, g(f(x)) = 4x - 2$
b $f(g(x)) = 8x + 5, g(f(x)) = 8x + 3$
c $f(g(x)) = 4x - 7, g(f(x)) = 4x - 5$
d $f(g(x)) = 2x^2 - 1, g(f(x)) = (2x - 1)^2$
e $f(g(x)) = 2(x - 5)^2 + 1, g(f(x)) = 2x^2 - 4$
f $f(g(x)) = 2x^2 + 1, g(f(x)) = (2x + 1)^2$
- 2 a** $f(h(x)) = 6x + 3$
b $h(f(x)) = 6x - 1$ **c** 15
d 11 **e** 21 **f** $-x$
g 3
- 3 a** $9x^2 + 12x + 3$
b $3x^2 + 6x + 1$ **c** 120
d 46 **e** 3 **f** 1
- 4 a** $h(g(x)) = \frac{1}{(3x + 2)^2}, \text{dom}(h \circ g) = \mathbb{R}^+$
b $g(h(x)) = \frac{3}{x^2} + 2, \text{dom}(g \circ h) = \mathbb{R} \setminus \{0\}$
c $\frac{1}{25}$ **d** 5
- 5 a** $\text{ran } f = [-4, \infty), \text{ran } g = [0, \infty)$
b $f \circ g(x) = x - 4, \text{ran}(f \circ g) = [-4, \infty)$
c $\text{ran } f \not\subseteq \text{dom } g$
- 6 a** $f \circ g(x) = x, \text{dom} = \mathbb{R} \setminus \{\frac{1}{2}\}, \text{ran} = \mathbb{R} \setminus \{\frac{1}{2}\}$
b $g \circ f(x) = x, \text{dom} = \mathbb{R} \setminus \{0\}, \text{ran} = \mathbb{R} \setminus \{0\}$

- 7 a** $\text{ran } f = [-2, \infty) \not\subseteq \text{dom } g = \mathbb{R}^+ \cup \{0\}$
b $f \circ g(x) = x - 2, x \geq 0$

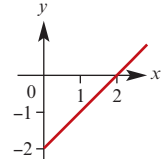

- 8 a** $\text{ran } g = [-1, \infty) \not\subseteq \text{dom } f = (-\infty, 3]$
b $g^*: [-2, 2] \rightarrow \mathbb{R}, g^*(x) = x^2 - 1$
 $f \circ g^*: [-2, 2] \rightarrow \mathbb{R}, f \circ g^*(x) = 4 - x^2$
- 9 a** $\text{ran } g = \mathbb{R} \not\subseteq \text{dom } f = \mathbb{R}^+$
b $g_1: (-\infty, 3) \rightarrow \mathbb{R}, g_1(x) = 3 - x$

10

	Domain	Range
f	\mathbb{R}	$[0, \infty)$
g	$(-\infty, 3]$	$[0, \infty)$

- a** $\text{ran } g \subseteq \text{dom } f$, so $f \circ g$ exists
b $\text{ran } f \not\subseteq \text{dom } g$, so $g \circ f$ does not exist
- 11 a** $S = [-2, 2]$
b $\text{ran } f = [0, 2], \text{ran } g = [1, \infty)$
c $\text{ran } f \subseteq \text{dom } g$, so $g \circ f$ is defined;
 $\text{ran } g \not\subseteq \text{dom } f$, so $f \circ g$ is not defined
- 12** $a \in [2, 3]$
- 13 a** $f \circ g(x) = 4 - |x|, g \circ f(x) = |4 - x|$

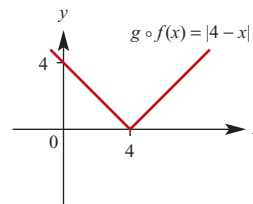
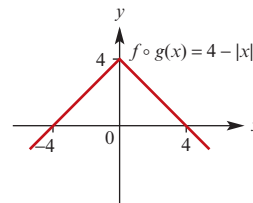

- b** $f \circ g(x) = 9 - |x|^2 = 9 - x^2$
 $g \circ f(x) = |9 - x^2|$

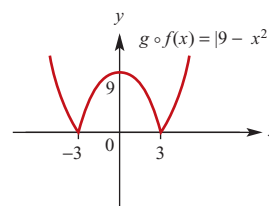
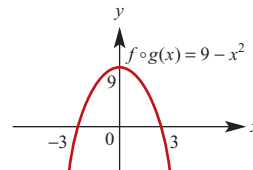

c $f \circ g(x) = \frac{1}{|x|}$, $g \circ f(x) = \left| \frac{1}{x} \right| = \frac{1}{|x|}$

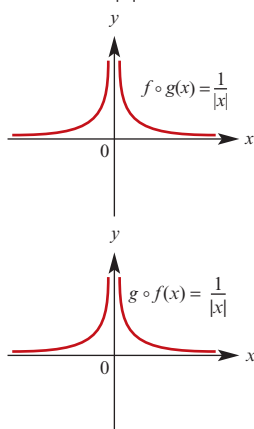

Exercise 2C

- 1 One-to-one functions: b, c
- 2 One-to-one functions: b, d, f, h
- 3 One-to-one functions: b, e

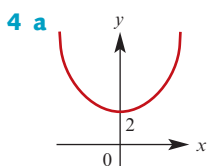

b $g_1(x) = x^2 + 2, x \geq 0$
 $g_2(x) = x^2 + 2, x < 0$

Exercise 2D

- | | |
|---|---|
| 1 a $f^{-1}(x) = \frac{x-3}{2}$ | b $f^{-1}(x) = \frac{4-x}{3}$ |
| c $f^{-1}(x) = \frac{x-3}{4}$ | |
| 2 a $f^{-1}(x) = x + 4$ | b $f^{-1}(x) = \frac{x}{2}$ |
| c $f^{-1}(x) = \frac{4x}{3}$ | d $f^{-1}(x) = \frac{4x+2}{3}$ |
| 3 a $f^{-1}(x) = \frac{1}{2}(x+4)$
dom = [-8, 8]
ran = [-2, 6] | b $g^{-1}(x) = 9 - \frac{1}{x}$
dom = $(-\infty, 0)$
ran = (9, ∞) |
| c $h^{-1}(x) = \sqrt{x-2}$
dom = [2, ∞)
ran = $\mathbb{R}^+ \cup \{0\}$ | d $f^{-1}(x) = \frac{1}{5}(x+2)$
dom = [-17, 28]
ran = [-3, 6] |
| e $g^{-1}(x) = \sqrt{x+1}$
dom = (0, ∞)
ran = (1, ∞) | f $h^{-1}(x) = x^2$
dom = (0, ∞)
ran = (0, ∞) |

4 a $g^{-1}(x) = \sqrt{x+1} - 1$
 $\text{dom } g^{-1} = [-1, \infty)$, $\text{ran } g^{-1} = [-1, \infty)$

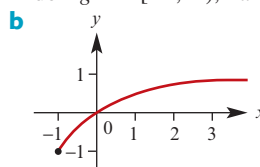

5 $f^{-1}: \mathbb{R} \setminus \{-3\} \rightarrow \mathbb{R}, f^{-1}(x) = \frac{1}{x+3}$

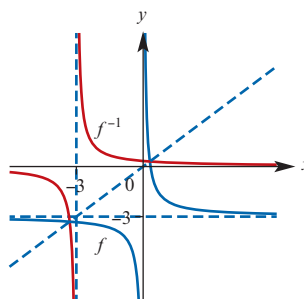

Intersection points: $\left(\frac{-3 + \sqrt{13}}{2}, \frac{-3 + \sqrt{13}}{2} \right)$
 $\left(\frac{-3 - \sqrt{13}}{2}, \frac{-3 - \sqrt{13}}{2} \right)$

6 $f^{-1}(2) = \frac{1}{2}$, $\text{dom } f^{-1} = [-3, 3]$

7 a $f^{-1}(x) = \frac{x}{2}$,
 $\text{dom } f^{-1} = [-2, 6]$, $\text{ran } f^{-1} = [-1, 3]$

b $f^{-1}(x) = \sqrt{\frac{x+4}{2}}$,
 $\text{dom } f^{-1} = [-4, \infty)$, $\text{ran } f^{-1} = [0, \infty)$

c $\{(6, 1), (4, 2), (8, 3), (11, 5)\}$,
 $\text{dom} = \{6, 4, 8, 11\}$, $\text{ran} = \{1, 2, 3, 5\}$

d $h^{-1}(x) = -x^2$, $\text{dom } h^{-1} = \mathbb{R}^+$, $\text{ran } h^{-1} = \mathbb{R}^-$

e $f^{-1}(x) = \sqrt[3]{x-1}$, $\text{dom } f^{-1} = \mathbb{R}$, $\text{ran } f^{-1} = \mathbb{R}$

f $g^{-1}(x) = -1 + \sqrt{x}$,
 $\text{dom } g^{-1} = (0, 16)$, $\text{ran } g^{-1} = (-1, 3)$

g $g^{-1}(x) = x^2 + 1$,
 $\text{dom } g^{-1} = \mathbb{R}^+ \cup \{0\}$, $\text{ran } g^{-1} = [1, \infty)$

h $h^{-1}(x) = \sqrt{4-x^2}$,
 $\text{dom } h^{-1} = [0, 2]$, $\text{ran } h^{-1} = [0, 2]$

8 a $y = \frac{x-4}{2}$
 $\text{dom} = \mathbb{R}$
 $\text{ran} = \mathbb{R}$

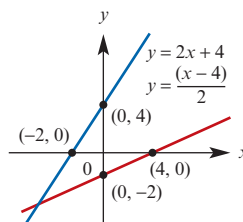

b $f^{-1}(x) = 3 - 2x$
 dom = \mathbb{R}
 ran = \mathbb{R}

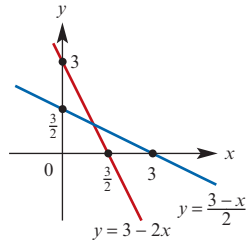

c $f^{-1}(x) = \sqrt{x} + 2$
 dom = $\mathbb{R}^+ \cup \{0\}$
 ran = $[2, \infty)$

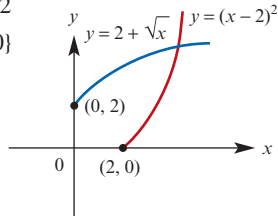

d $f^{-1}(x) = \sqrt{x} + 1$
 dom = $\mathbb{R}^+ \cup \{0\}$
 ran = $[1, \infty)$

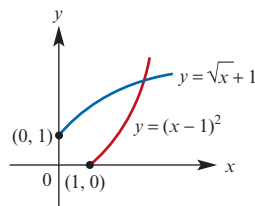

e $f^{-1}(x) = 2 - \sqrt{x}$
 dom = $\mathbb{R}^+ \cup \{0\}$
 ran = $(-\infty, 2]$

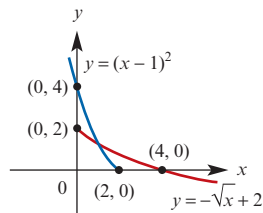

f $f^{-1}(x) = \frac{1}{x}$
 dom = \mathbb{R}^+
 ran = \mathbb{R}^+

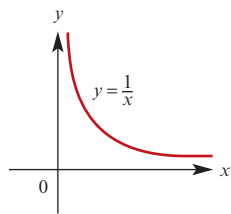

g $f^{-1}(x) = \frac{1}{\sqrt{x}}$
 dom = \mathbb{R}^+
 ran = \mathbb{R}^+

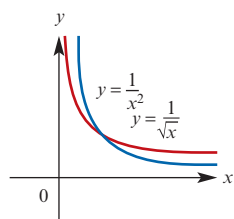

h $h^{-1}(x) = 2x + 4$
 dom = \mathbb{R}
 ran = \mathbb{R}

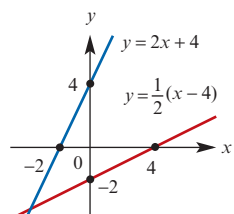

9 a $f^{-1}: [2, \infty) \rightarrow \mathbb{R}$,
 $f^{-1}(x) = (x - 2)^2$

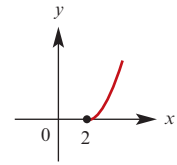

b $f^{-1}: \mathbb{R} \setminus \{0\} \rightarrow \mathbb{R}$,
 $f^{-1}(x) = \frac{1}{x} + 3$

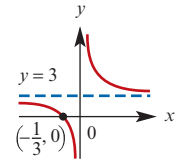

c $f^{-1}: [4, \infty) \rightarrow \mathbb{R}$,
 $f^{-1}(x) = (x - 4)^2 + 2$

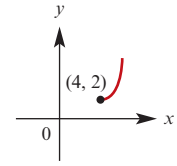

d $f^{-1}: \mathbb{R} \setminus \{1\} \rightarrow \mathbb{R}$,
 $f^{-1}(x) = \frac{3}{x-1} + 2$

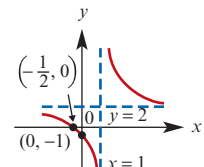

e $f^{-1}: \mathbb{R} \setminus \{-1\} \rightarrow \mathbb{R}$,
 $f^{-1}(x) = \frac{5}{x+1} + 1$

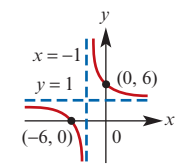

f $f^{-1}: [1, \infty) \rightarrow \mathbb{R}$,
 $f^{-1}(x) = 2 - (x - 1)^2$

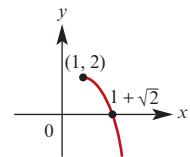

10 a $f^{-1}: \mathbb{R} \setminus \{1\} \rightarrow \mathbb{R}$, $f^{-1}(x) = \frac{x+1}{x-1}$

b $f^{-1}: \mathbb{R}^+ \cup \{0\} \rightarrow \mathbb{R}$, $f^{-1}(x) = x^2 + 2$

c $f^{-1}: \mathbb{R} \setminus \{\frac{2}{3}\} \rightarrow \mathbb{R}$, $f^{-1}(x) = \frac{2x+3}{3x-2}$

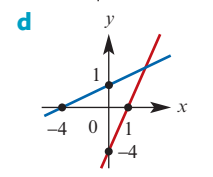
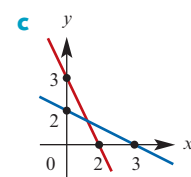
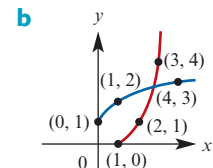
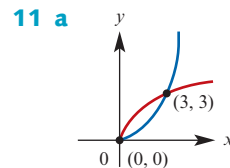

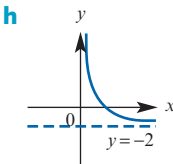
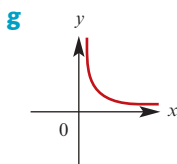
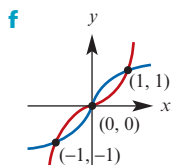
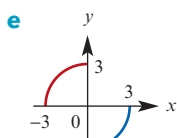

12 a C b B c D d A

13 a $A = (-\infty, 3]$
 b $b = 0, g^{-1}(x) = \sqrt{1-x}, x \in [-3, 1]$

14 $b = -2, g^{-1}(x) = -2 + \sqrt{x+4}$

15 $a = 3, f^{-1}(x) = 3 - \sqrt{x+9}$

16 a $y = \frac{3}{x}$ domain = $\mathbb{R} \setminus \{0\}$

b $y = (x+4)^3 - 2$ domain = \mathbb{R}

c $y = (2-x)^2$ domain = $(-\infty, 2]$

d $y = \frac{3}{x-1}$ domain = $\mathbb{R} \setminus \{1\}$

e $y = \sqrt[3]{\frac{2}{5-x}} + 6$ domain = $\mathbb{R} \setminus \{5\}$

f $y = \frac{1}{(x-2)^{\frac{4}{3}}} + 1$ domain = $(2, \infty)$

17 a Inverse is a function

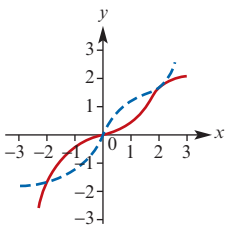

b Inverse is not a function

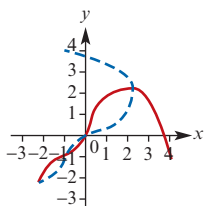

c Inverse is not a function

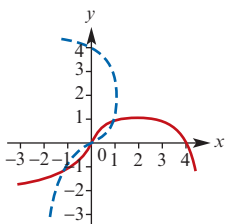

d Inverse is a function

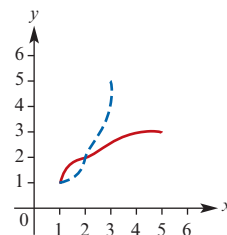

e Inverse is not a function

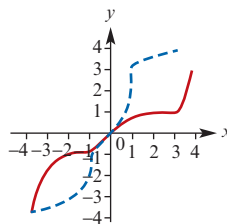

18 a $\text{dom } f = \mathbb{R} \setminus \{\frac{1}{2}\}, \text{ran } f = \mathbb{R} \setminus \{\frac{1}{2}\},$
 $f \circ f$ is defined as $\text{ran } f \subseteq \text{dom } f$

b $f \circ f(x) = x, x \in \mathbb{R} \setminus \{\frac{1}{2}\}$

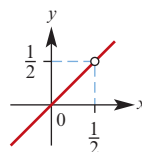

c $f^{-1}: \mathbb{R} \setminus \{\frac{1}{2}\} \rightarrow \mathbb{R}, f^{-1}(x) = \frac{x+3}{2x-1}$

Exercise 2E

1 a i $f \circ g(x) = 3 \sin(2|x|), g \circ f(x) = 3|\sin(2x)|$

ii $\text{ran}(f \circ g) = [-3, 3], \text{dom}(f \circ g) = \mathbb{R},$
 $\text{ran}(g \circ f) = [0, 3], \text{dom}(g \circ f) = \mathbb{R}$

b i $f \circ g(x) = -2 \cos(2|x|),$

$g \circ f(x) = 2|\cos(2x)|$

ii $\text{ran}(f \circ g) = [-2, 2], \text{dom}(f \circ g) = \mathbb{R},$
 $\text{ran}(g \circ f) = [0, 2], \text{dom}(g \circ f) = \mathbb{R}$

c i $f \circ g(x) = e^{|x|}, g \circ f(x) = e^x$

ii $\text{ran}(f \circ g) = [1, \infty), \text{dom}(f \circ g) = \mathbb{R},$
 $\text{ran}(g \circ f) = (0, \infty), \text{dom}(g \circ f) = \mathbb{R}$

d i $f \circ g(x) = e^{2|x|} - 1, g \circ f(x) = |e^{2x} - 1|$

ii $\text{ran}(f \circ g) = [0, \infty), \text{dom}(f \circ g) = \mathbb{R},$
 $\text{ran}(g \circ f) = [0, \infty), \text{dom}(g \circ f) = \mathbb{R}$

e i $f \circ g(x) = -2e^{|x|} - 1, g \circ f(x) = 2e^x + 1$

ii $\text{ran}(f \circ g) = (-\infty, -3], \text{dom}(f \circ g) = \mathbb{R},$
 $\text{ran}(g \circ f) = (1, \infty), \text{dom}(g \circ f) = \mathbb{R}$

f i $f \circ g(x) = \ln(2|x|), g \circ f(x) = |\ln(2x)|$

ii $\text{ran}(f \circ g) = \mathbb{R}, \text{dom}(f \circ g) = \mathbb{R} \setminus \{0\},$
 $\text{ran}(g \circ f) = [0, \infty), \text{dom}(g \circ f) = \mathbb{R}^+$

g i $f \circ g(x) = \ln(|x| - 1), g \circ f(x) = |\ln(x - 1)|$

ii $\text{ran}(f \circ g) = \mathbb{R}, \text{dom}(f \circ g) = \mathbb{R} \setminus [-1, 1],$
 $\text{ran}(g \circ f) = [0, \infty), \text{dom}(g \circ f) = (1, \infty)$

h i $f \circ g(x) = -\ln|x|, g \circ f(x) = |\ln x|$

ii $\text{ran}(f \circ g) = \mathbb{R}, \text{dom}(f \circ g) = \mathbb{R} \setminus \{0\},$
 $\text{ran}(g \circ f) = [0, \infty), \text{dom}(g \circ f) = \mathbb{R}^+$

- 2 a** $h(x) = f \circ g(x)$, $f(x) = e^x$, $g(x) = x^3$
b $h(x) = f \circ g(x)$, $f(x) = \cos x$, $g(x) = |2x|$
c $h(x) = f \circ g(x)$, $f(x) = x^2$, $g(x) = x^2 - 2x$
d $h(x) = f \circ g(x)$, $f(x) = \cos x$, $g(x) = x^2$
e $h(x) = f \circ g(x)$, $f(x) = x^2$, $g(x) = \cos x$
f $h(x) = f \circ g(x)$, $f(x) = x^4$, $g(x) = x^2 - 1$
g $h(x) = f \circ g(x)$, $f(x) = \ln x$, $g(x) = x^2$
h $h(x) = f \circ g(x)$, $f(x) = |x|$, $g(x) = \cos(2x)$
i $h(x) = f \circ g(x)$, $f(x) = x^3 - 2x$,
 $g(x) = x^2 - 2x$

- 3 a** $f^{-1}: (0, \infty) \rightarrow \mathbb{R}$, $f^{-1}(x) = \frac{1}{3} \ln\left(\frac{x}{4}\right)$
b $g^{-1}: \mathbb{R} \setminus \{0\} \rightarrow \mathbb{R}$, $g^{-1}(x) = \frac{8}{x^3}$
c $f \circ g: \mathbb{R} \setminus \{0\} \rightarrow \mathbb{R}$, $f \circ g(x) = 4e^{\frac{6}{\sqrt{x}}}$
d $g \circ f: \mathbb{R} \rightarrow \mathbb{R}$, $g \circ f(x) = \frac{2}{\sqrt[3]{4e^{3x}}}$
e $(f \circ g)^{-1}: \mathbb{R}^+ \rightarrow \mathbb{R}$, $(f \circ g)^{-1}(x) = \left(\frac{6}{\ln\left(\frac{x}{4}\right)}\right)^3$
f $(g \circ f)^{-1}: \mathbb{R}^+ \rightarrow \mathbb{R}$, $(g \circ f)^{-1}(x) = \frac{1}{3} \ln\left(\frac{2}{x^3}\right)$

- 4 a** $2e^{2x}$ **b** $\frac{1}{2} \ln\left(\frac{x}{2}\right)$ **c** e^{x^2}
5 a $f^{-1}(x) = -\frac{1}{2} \ln x$, $g^{-1}(x) = (x-1)^{\frac{1}{3}}$
b $f \circ g(x) = e^{-2(x^3+1)}$, $\text{ran}(f \circ g) = \mathbb{R}^+$,
 $g \circ f(x) = e^{-6x} + 1$, $\text{ran}(g \circ f) = (1, \infty)$
6 a $f^{-1}(x) = \frac{1}{x} - 1$ **b** $x = \frac{\sqrt{5}-1}{2}$
7 a $f^{-1}(x) = e^x - 1$, $\text{dom } f^{-1} = \mathbb{R}$,
 $g^{-1}(x) = \sqrt{x+1} - 1$, $\text{dom } g^{-1} = (-1, \infty)$
b $\ln(x^2 + 2x + 1)$

- 8** $f \circ g(x) = \ln\left(\frac{1}{x}\right)$, $f(x) + f \circ g(x) = 0$
9 x
10 $x = \pm\sqrt{6}$ or $x = \pm\sqrt{2}$
12 $a = \frac{1}{6}$, $b = -\frac{1}{2}$
14 $b = 0$, $a = 6$, $g(x) = e^{6x}$
15 a $f^{-1}: [1, \infty) \rightarrow \mathbb{R}$, $f^{-1}(x) = \ln(x + \sqrt{x^2 - 1})$
b $g^{-1}: \mathbb{R} \rightarrow \mathbb{R}$, $g^{-1}(x) = \ln(x + \sqrt{x^2 + 1})$
16 a $g(f(a)) = g(f(b)) \Rightarrow f(a) = f(b) \Rightarrow a = b$
b $f(a) = f(b) \Rightarrow g(f(a)) = g(f(b)) \Rightarrow a = b$
c $f(x) = e^x$, $g(x) = x^2$, $g \circ f(x) = e^{2x}$

Chapter 2 review

Short-answer questions

- 1 a** 9 **b** $\frac{1}{400}$ **c** 4 **d** 4
e $\pi - 3$ **f** $4 - \pi$
2 a $(0, 10^{-4})$ **b** $(100, \infty)$
3 $x = 0$ or $x = 2$ or $x = 4$

- 4 a** Range $[0, 2]$

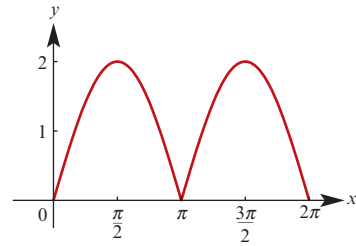

- b** Range $[-3, \infty)$

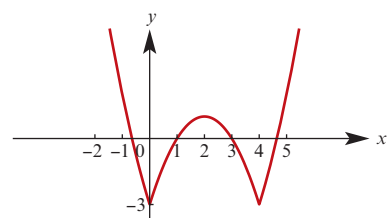

- c** Range $(-\infty, 3]$

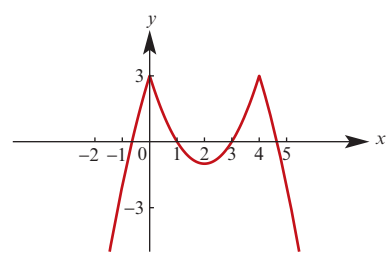

- 5 a** $\{5\}$ **b** $\{11\}$ **c** $\left\{\frac{11}{7}\right\}$

- 6** $f^{-1}: [8, \infty) \rightarrow \mathbb{R}$, $f^{-1}(x) = \sqrt{x+1}$
7

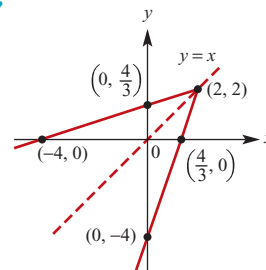

- 8 a** $f^{-1}: \mathbb{R} \rightarrow \mathbb{R}$, $f^{-1}(x) = \frac{1}{2}x^{\frac{1}{3}}$
b $f^{-1}: (-\infty, 0] \rightarrow \mathbb{R}$, $f^{-1}(x) = \frac{1}{2}x^{\frac{1}{5}}$
c $f^{-1}: [0, \infty) \rightarrow \mathbb{R}$, $f^{-1}(x) = \frac{1}{2}x^{\frac{1}{6}}$
d $f^{-1}: (10\,000, \infty) \rightarrow \mathbb{R}$, $f^{-1}(x) = \frac{1}{10}x^{\frac{1}{4}}$
9 a $(5 - x^3)^2$ **b** $2 - (x+3)^6$
c $2 - (2 - x^3)^3$ **d** $(x^2 + 6x + 12)^2$
10 $(-\infty, -\sqrt[3]{2}) \cup [\sqrt[3]{4}, \infty)$
11 $h^{-1}(x) = \left(\frac{x-64}{2}\right)^{\frac{1}{5}}$

12 $f^{-1}: [4, \infty) \rightarrow \mathbb{R}, f^{-1}(x) = (x-4)^2 + 2$

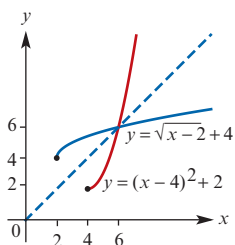

13 $f^{-1}: \mathbb{R} \setminus \{1\} \rightarrow \mathbb{R}, f^{-1}(x) = \frac{x+2}{1-x}$

14 a $f(x) = \sqrt{1+x}$ b $f(x) = x^2 - x$
 c $f(x) = 3x^3 - 2x^2 - x + 2$

Multiple-choice questions

- 1 E 2 A 3 A 4 C 5 D
 6 B 7 B 8 A 9 A 10 B
 11 A 12 C 13 B

Extended-response questions

- 1 a (0, 0), (a, 0) b (0, 0)
 c $\frac{a^2}{4}$ d 3, -5
 2 a $\text{ran } f = \mathbb{R} = \text{dom } g$, so $g \circ f$ exists;
 $g \circ f(x) = 2 + (1+x)^3$
 b $g \circ f$ is one-to-one, so $(g \circ f)^{-1}$ exists;
 $(g \circ f)^{-1}(10) = 1$

- 3 a $\mathbb{R} \setminus \{-2\}$
 b Dilation of factor 24 from the x -axis, then translation 2 units to the left and 6 units down
 c (0, 6), (2, 0)
 d $g^{-1}(x) = \frac{24}{x+6} - 2$
 e Domain of $g^{-1} = \text{range of } g = (-6, \infty)$

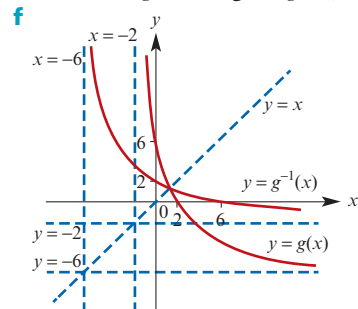

- g $x = -4 + 2\sqrt{7}$
 4 a $[-3, \infty)$
 b Dilation of factor $\frac{1}{2}$ from the y -axis, dilation of factor 2 from the x -axis, reflection in the x -axis, then translation 3 units to the left and 4 units up
 c (0, 4 - 2\sqrt{6}), (-1, 0)
 d $f^{-1}(x) = \frac{(x-4)^2}{8} - 3$
 e Domain of $f^{-1} = \text{range of } f = (-\infty, 4]$

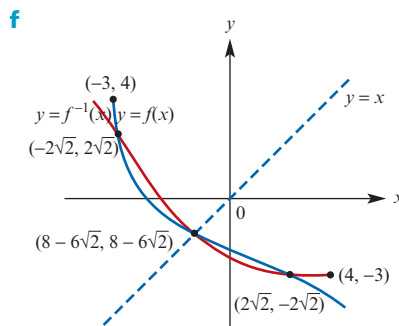

g $x = 8 - 6\sqrt{2}$ or $x = 2\sqrt{2}$ or $x = -2\sqrt{2}$

5 a $\mathbb{R} \setminus \left\{\frac{4}{3}\right\}$ b $\frac{4}{3}$

c $f^{-1}(x) = \frac{4}{3} + \frac{1}{3}\sqrt{\frac{3}{x-6}}$ d $x = 6.015$

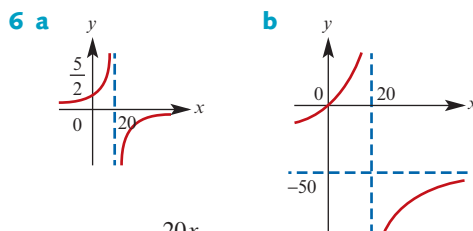
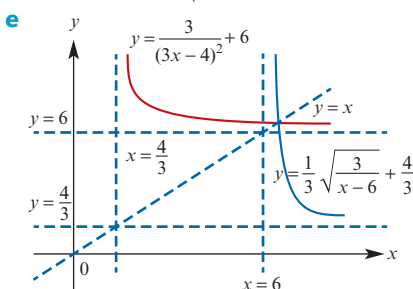

c $g^{-1}(x) = \frac{20x}{50+x}$

7 a $f: \mathbb{R} \setminus \left\{\frac{a}{c}\right\} \rightarrow \mathbb{R}, f^{-1}(x) = \frac{b-dx}{cx-a}$

b i $f^{-1}: \mathbb{R} \setminus \{1\} \rightarrow \mathbb{R}, f^{-1}(x) = \frac{2-x}{3x-3}$

ii $f^{-1}: \mathbb{R} \setminus \left\{\frac{3}{2}\right\} \rightarrow \mathbb{R}, f^{-1}(x) = \frac{3x+2}{2x-3}$

iii $f^{-1}: \mathbb{R} \setminus \{-1\} \rightarrow \mathbb{R}, f^{-1}(x) = \frac{1-x}{x+1}$

iv $f^{-1}: \mathbb{R} \setminus \{-1\} \rightarrow \mathbb{R}, f^{-1}(x) = \frac{1-x}{x+1}$

c For $a, b, c, d \in \mathbb{R} \setminus \{0\}$, $f = f^{-1}$ when $a = -d$

8 a i $y = f^{-1}(x-5) + 3$ ii $y = f^{-1}(x-3) + 5$

iii $y = 5f^{-1}\left(\frac{x}{3}\right)$ iv $y = 3f^{-1}\left(\frac{x}{5}\right)$

b $y = cf^{-1}\left(\frac{x-b}{a}\right) + d$

Reflection in the line $y = x$, then dilation of factor c from the x -axis and factor a from the y -axis, and a translation b units to the right and d units up

Chapter 3

Exercise 3A

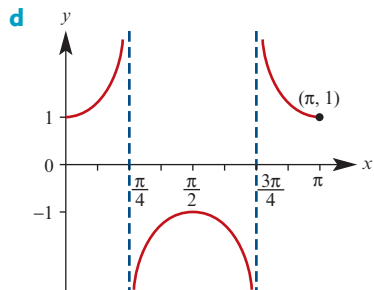
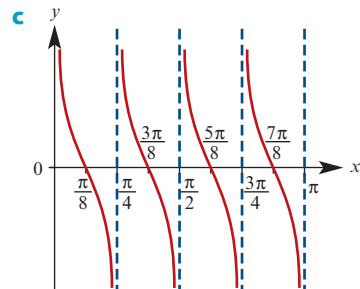
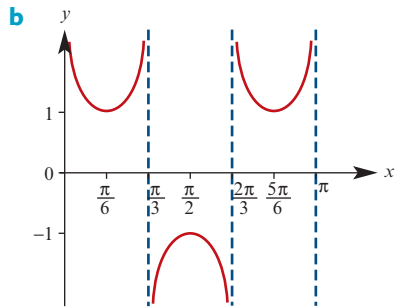
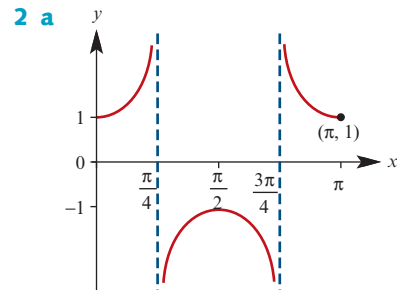
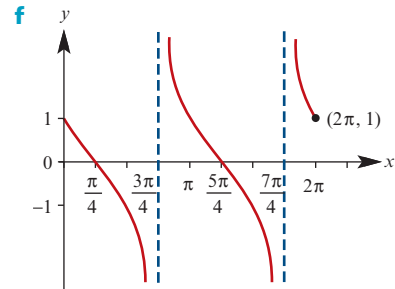
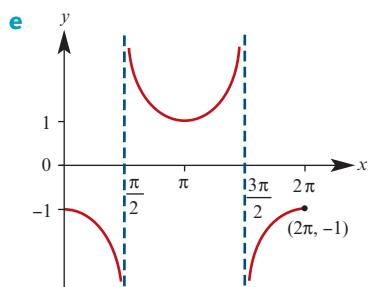
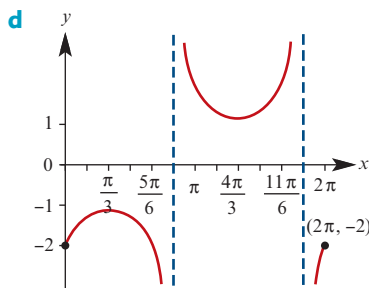
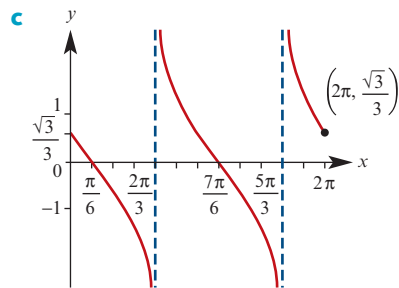
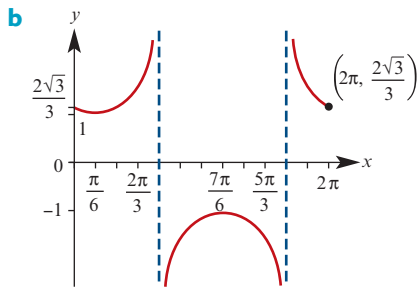
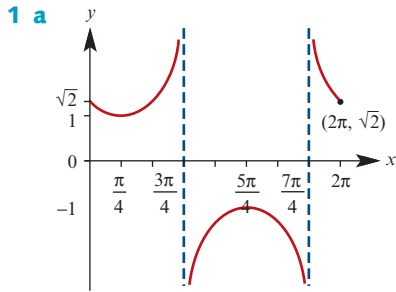

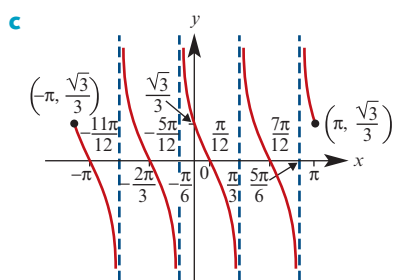
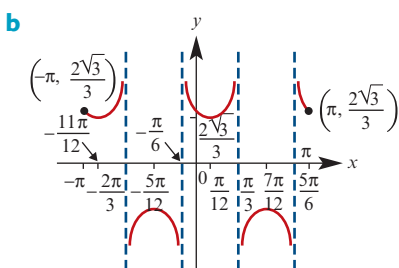
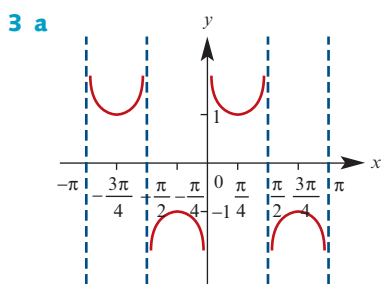
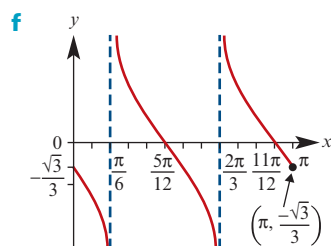
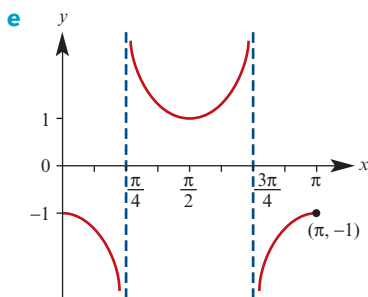

4 a $\cot x = \frac{5}{8}$, $\sec x = \frac{\sqrt{89}}{5}$, $\operatorname{cosec} x = \frac{\sqrt{89}}{8}$

b $\cot x = \frac{2\sqrt{6}}{5}$, $\sec x = \frac{7\sqrt{6}}{12}$, $\operatorname{cosec} x = \frac{7}{5}$

c $\cot x = \frac{7\sqrt{2}}{8}$, $\sec x = \frac{9}{7}$, $\operatorname{cosec} x = \frac{9\sqrt{2}}{8}$

5 a $\frac{\sqrt{3}}{2}$ **b** $-\frac{\sqrt{2}}{2}$ **c** -1 **d** 2

e $\sqrt{2}$ **f** $-\sqrt{3}$ **g** $-\frac{\sqrt{2}}{2}$ **h** $-\frac{\sqrt{3}}{3}$

i 2 **j** $\sqrt{2}$ **k** 1 **l** $\frac{1}{2}$

6 a 1 **b** -1 **c** $\operatorname{cosec}^2 x$ **d** $\sec x$

e $\sin^2 x - \cos^2 x = -\cos(2x)$

f $\tan x \sec^2 x$

7 a $\sqrt{17}$ **b** $\frac{\sqrt{17}}{17}$ **c** $-\frac{\sqrt{17}}{4}$

8 a $-\sqrt{10}$ **b** $-\frac{\sqrt{10}}{10}$ **c** $-\frac{\sqrt{10}}{3}$

9 a $-3\sqrt{11}$ **b** $\frac{-3\sqrt{11}}{10}$

10 a $-\sqrt{35}$ **b** $\frac{\sqrt{35}}{6}$

11 a $\frac{-\sqrt{3}}{2}$ **b** $-\sqrt{3}$ **c** 2

12 a $-\frac{1}{3}$ **b** $-\frac{2\sqrt{2}}{3}$ **c** $-\frac{3\sqrt{2}}{4}$

13 a $\frac{\sqrt{51}}{10}$ **b** $-\frac{\sqrt{51}}{7}$ **c** $-\frac{7\sqrt{51}}{51}$

14 a 0.2 **b** $-\frac{2\sqrt{6}}{5}$ **c** $-\frac{\sqrt{6}}{12}$

15 a 0 **b** $\frac{1}{2} \sin(2\theta)$ **c** 1 **d** 1

16 $x - \frac{1}{x} = -2 \tan \theta$

Exercise 3B

1 a $\frac{\sqrt{2}}{4}(\sqrt{3} - 1)$ **b** $2 + \sqrt{3}$

c $\frac{\sqrt{2}}{4}(1 - \sqrt{3})$ **d** $2 - \sqrt{3}$

2 a $\sin(2x) \cos(5y) - \cos(2x) \sin(5y)$

b $\cos(x^2) \cos(y) - \sin(x^2) \sin(y)$

c $\frac{\tan x + \tan y + \tan z - \tan x \tan y \tan z}{1 - \tan x \tan y - \tan x \tan z - \tan y \tan z}$

3 a $\sin(x - 2y)$ **b** $\cos x$ **c** $\tan B$

d $\sin(2A)$ **e** $\cos y$

4 a $\sin x \cos(2x) + \cos x \sin(2x)$

b $3 \sin x - 4 \sin^3 x$

5 a $\cos x \cos(2x) - \sin x \sin(2x)$

b $4 \cos^3 x - 3 \cos x$

6 a -0.8 **b** 2.6 **c** $\frac{5}{13}$ **d** $\frac{12}{13}$ **e** -0.75

f $\frac{16}{65}$ **g** $\frac{63}{65}$ **h** $\frac{33}{56}$ **i** $\frac{-837}{116}$

7 a $\frac{-\sqrt{51}}{10}$ **b** $\frac{\sqrt{21}}{5}$ **c** 0.40 **d** -0.36

8 a $\frac{1}{4} \sin(2x)$ **b** $-\cos(2x)$ **c** $\frac{1}{2} \tan(2x)$

d -1 **e** $-2 \tan x$ **f** $\sin(2x)$

- 9 a 0.96 b -0.28 c $-\frac{24}{7}$
 10 a $-\frac{3}{4}$ b $\frac{9}{13}$
 11 a -0.66 b 0.91
 12 $\sqrt{2} - 1$
 13 0.97
 14 a $\frac{12}{5}$ b $\frac{2}{3}$ c $3\frac{1}{3}$ m

Exercise 3C

1 a $\text{dom} = \mathbb{R}, \text{ran} = \left(-\frac{\pi}{2}, \frac{\pi}{2}\right)$

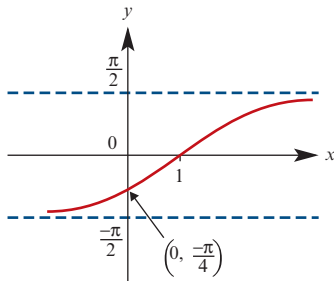

b $\text{dom} = [-2, 0], \text{ran} = [0, \pi]$

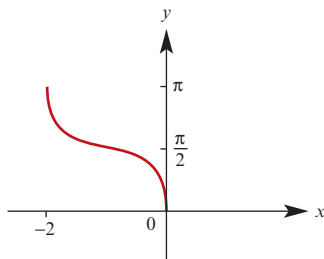

c $\text{dom} = \left[-\frac{3}{2}, \frac{1}{2}\right], \text{ran} = [-\pi, \pi]$

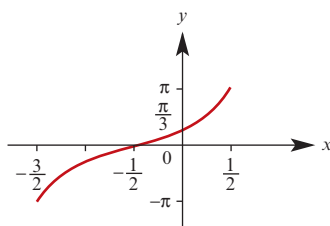

d $\text{dom} = \mathbb{R}, \text{ran} = \left(-\frac{\pi}{2}, \frac{3\pi}{2}\right)$

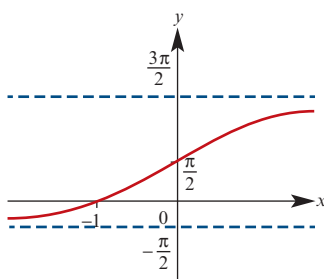

e $\text{dom} = \left[-\frac{1}{2}, \frac{1}{2}\right], \text{ran} = [0, \pi]$

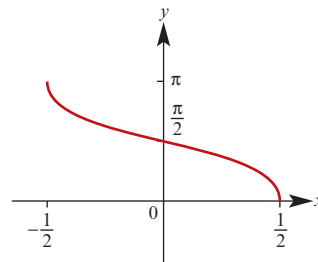

f $\text{dom} = \left[-\frac{1}{3}, \frac{1}{3}\right], \text{ran} = \left[0, \frac{\pi}{2}\right]$

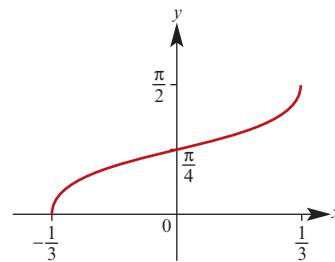

2 a $\frac{\pi}{2}$ b $-\frac{\pi}{4}$ c $\frac{\pi}{6}$ d $\frac{5\pi}{6}$ e $\frac{\pi}{3}$

f $\frac{\pi}{4}$ g $-\frac{\pi}{3}$ h $\frac{\pi}{6}$ i π

3 a $\frac{\sqrt{3}}{2}$ b $-\frac{\pi}{3}$ c -1 d $\frac{\sqrt{2}}{2}$ e $\frac{\pi}{4}$

f $\sqrt{3}$ g $\frac{\pi}{3}$ h $-\frac{\pi}{3}$ i $-\frac{\pi}{4}$ j $\frac{5\pi}{6}$

k π l $-\frac{\pi}{4}$

4 a $f^{-1}: [-1, 1] \rightarrow \mathbb{R}, f^{-1}(x) = y,$
 where $\sin y = x$ and $y \in \left[\frac{\pi}{2}, \frac{3\pi}{2}\right]$

$(f^{-1}(x) = \pi - \sin^{-1}(x))$

b i 1 ii $\frac{1}{\sqrt{2}}$ iii $-\frac{1}{2}$ iv $\frac{3\pi}{2}$ v π vi $\frac{5\pi}{6}$

5 a $[1, 3], \left[-\frac{\pi}{2}, \frac{\pi}{2}\right]$ b $\left[\frac{-3\pi}{4}, \frac{\pi}{4}\right], [-1, 1]$

c $\left[\frac{-5}{2}, \frac{-3}{2}\right], \left[\frac{-\pi}{2}, \frac{\pi}{2}\right]$ d $\left[-\frac{\pi}{18}, \frac{5\pi}{18}\right], [-1, 1]$

e $\left[\frac{\pi}{6}, \frac{7\pi}{6}\right], [-1, 1]$ f $[-2, 0], [0, \pi]$

g $[-1, 1], \left[0, \frac{\pi}{2}\right]$ h $\left[-\frac{\pi}{3}, \frac{\pi}{6}\right], [-1, 1]$

i $\mathbb{R}, \left[0, \frac{\pi}{2}\right)$ j $\left(0, \frac{\pi}{2}\right), \mathbb{R}$

k $\mathbb{R}, \left(-\frac{\pi}{2}, \frac{\pi}{2}\right)$

l $\left(\frac{-\sqrt{2}\pi}{2}, \frac{\sqrt{2}\pi}{2}\right), \mathbb{R}^+ \cup \{0\}$

6 a $\frac{3}{5}$ b $\frac{12}{5}$ c $\frac{24}{25}$ d $\frac{40}{9}$ e $\sqrt{3}$

f $\frac{\sqrt{5}}{3}$ g $\frac{-2\sqrt{5}}{5}$ h $\frac{2\sqrt{10}}{7}$ i $\frac{7\sqrt{149}}{149}$

- 7 a** i $\frac{4}{5}$ ii $\frac{12}{13}$
8 a $[0, \pi]$, $[-\frac{\pi}{2}, \frac{\pi}{2}]$ **b** $[0, 1]$, $[0, 1]$
c $[-\frac{\pi}{4}, \frac{\pi}{4}]$, $[0, \pi]$ **d** $[0, 1]$, $[-1, 0]$
e $[0, 1]$, $[-1, 1]$ **f** $[0, \pi]$, $[-\frac{\pi}{4}, \frac{\pi}{4}]$
g $\mathbb{R}^+ \cup \{0\}$, $(0, 1]$ **h** \mathbb{R} , $(-1, 1)$

Exercise 3D

- 1 a** $\frac{7\pi}{6}$, $\frac{11\pi}{6}$ **b** $\frac{\pi}{12}$, $\frac{17\pi}{12}$ **c** $\frac{\pi}{6}$, $\frac{11\pi}{6}$
d $\frac{\pi}{4}$, $\frac{5\pi}{4}$ **e** $\frac{5\pi}{6}$, $\frac{11\pi}{6}$
f $\frac{\pi}{24}$, $\frac{13\pi}{24}$, $\frac{25\pi}{24}$, $\frac{37\pi}{24}$
2 a $\frac{\pi}{6}$, $\frac{5\pi}{6}$ **b** $\frac{5\pi}{6}$, $\frac{7\pi}{6}$ **c** $\frac{\pi}{3}$, $\frac{4\pi}{3}$
d $\frac{3\pi}{4}$, $\frac{7\pi}{4}$ **e** $\frac{2\pi}{3}$, $\frac{4\pi}{3}$ **f** $\frac{5\pi}{4}$, $\frac{7\pi}{4}$
3 a $x = \frac{\pi}{4} + 2n\pi$ or $x = \frac{3\pi}{4} + 2n\pi$, $n \in \mathbb{Z}$
b $x = 2n\pi$, $n \in \mathbb{Z}$
c $x = \frac{\pi}{6} + n\pi$, $n \in \mathbb{Z}$
d $x = \frac{(12n-5)\pi}{12}$ or $x = \frac{(4n+1)\pi}{4}$, $n \in \mathbb{Z}$
e $x = \frac{(2n-1)\pi}{3}$ or $x = \frac{2(3n+1)\pi}{9}$, $n \in \mathbb{Z}$
f $x = \frac{2n\pi}{3}$ or $x = \frac{(6n+1)\pi}{9}$, $n \in \mathbb{Z}$
g $x = \frac{(3n-2)\pi}{6}$, $n \in \mathbb{Z}$
h $x = \frac{n\pi}{2}$, $n \in \mathbb{Z}$
i $x = \frac{(8n-5)\pi}{8}$, $n \in \mathbb{Z}$
4 a ± 1.16 **b** -0.20 , -2.94
c 1.03 , -2.11
5 a $\frac{\pi}{4}$, $\frac{\pi}{2}$, $\frac{5\pi}{4}$, $\frac{3\pi}{2}$ **b** 0 , $\frac{\pi}{3}$, π , $\frac{5\pi}{3}$, 2π
c $\frac{\pi}{6}$, $\frac{\pi}{2}$, $\frac{5\pi}{6}$, $\frac{3\pi}{2}$
d $\frac{\pi}{24}$, $\frac{\pi}{8}$, $\frac{5\pi}{24}$, $\frac{3\pi}{8}$, $\frac{13\pi}{24}$, $\frac{5\pi}{8}$, $\frac{17\pi}{24}$, $\frac{7\pi}{8}$, $\frac{25\pi}{24}$, $\frac{9\pi}{8}$, $\frac{29\pi}{24}$, $\frac{11\pi}{8}$, $\frac{37\pi}{24}$, $\frac{13\pi}{8}$, $\frac{41\pi}{24}$, $\frac{15\pi}{8}$
e 0 , $\frac{2\pi}{3}$, $\frac{4\pi}{3}$, 2π **f** $\frac{\pi}{6}$, $\frac{5\pi}{6}$, $\frac{3\pi}{2}$
g 0 , $\frac{3\pi}{4}$, π , $\frac{7\pi}{4}$, 2π **h** $\frac{3\pi}{4}$, $\frac{7\pi}{4}$
i $\frac{\pi}{3}$, $\frac{5\pi}{3}$ **j** 0 , $\frac{\pi}{2}$, 2π

- 6 a** $\max = 3$, $\min = 1$ **b** $\max = 1$, $\min = \frac{1}{3}$
c $\max = 5$, $\min = 4$ **d** $\max = \frac{1}{4}$, $\min = \frac{1}{5}$
e $\max = 3$, $\min = -1$ **f** $\max = 9$, $\min = 5$
7 a $(-1.14, -2.28)$, $(0, 0)$, $(1.14, 2.28)$
b $(-1.24, -1.24)$, $(0, 0)$, $(1.24, 1.24)$
c $(3.79, -0.79)$ **d** $(0, 0)$, $(4.49, 4.49)$
8 $2\pi - q$
9 a $\pi + \alpha$, $2\pi - \alpha$ **b** $\frac{\pi}{2} - \alpha$, $\frac{3\pi}{2} + \alpha$
10 a $\pi - \beta$, $\beta - \pi$ **b** $\frac{\pi}{2} - \beta$, $\beta - \frac{3\pi}{2}$
11 a $2\pi - \gamma$, $3\pi - \gamma$ **b** $\frac{3\pi}{2} - \gamma$, $\frac{5\pi}{2} - \gamma$
12 0 , 0.33 , 2.16
13 1.50
14 b 45.07
15 0.86
16 1.93
17 b 1.113
18 When $t = 0$, $x_A = x_B = 0$;
when $t = 1.29$, $x_A = x_B = 0.48$
19 b 0.94

Chapter 3 review

Short-answer questions

- 1 a** $\frac{7}{25}$ **b** $\frac{24}{25}$ **c** $\frac{24}{7}$ **d** $\frac{5}{3}$ **e** $\frac{4}{3}$
2 a 0 , π , 2π , $\frac{\pi}{3}$, $-\frac{\pi}{3}$, $\frac{5\pi}{3}$
b $-\frac{\pi}{2}$, $\frac{\pi}{2}$, $\frac{3\pi}{2}$, $\frac{\pi}{3}$, $-\frac{\pi}{3}$, $\frac{5\pi}{3}$
c $-\frac{\pi}{2}$, $\frac{\pi}{2}$, $\frac{3\pi}{2}$ **d** $-\frac{\pi}{2}$, $\frac{\pi}{2}$, $\frac{3\pi}{2}$
e $\frac{\pi}{2}$, $-\frac{\pi}{6}$, $\frac{7\pi}{6}$, $\frac{11\pi}{6}$, $-\frac{5\pi}{6}$
f 0 , 2π , $\frac{\pi}{3}$, $-\frac{\pi}{3}$, $\frac{5\pi}{3}$
3 a $\frac{7\pi}{6}$, $\frac{11\pi}{6}$, $\sin^{-1}(\frac{1}{3})$, $\pi - \sin^{-1}(\frac{1}{3})$
b $\frac{\pi}{6}$, $\frac{5\pi}{6}$, $\frac{7\pi}{6}$, $\frac{11\pi}{6}$ **c** $\frac{\pi}{4}$, $\frac{5\pi}{4}$
d $\frac{\pi}{4}$, $\frac{3\pi}{4}$, $\frac{5\pi}{4}$, $\frac{7\pi}{4}$
4 a $-\frac{\sqrt{3}}{2}$ **b** $\frac{2\sqrt{3}}{3}$ **c** 2
d 2 **e** 1 **f** $-\sqrt{3}$
5 a $-p$ **b** $-p$ **c** $\frac{1}{p}$ **d** $-\frac{1}{p}$ **e** $-p$
6 a $\frac{\pi}{3}$ **b** $\frac{1}{2}$ **c** $\frac{2\pi}{3}$
d $\frac{2\pi}{3}$ **e** $\frac{\sqrt{3}}{2}$ **f** $\frac{\sqrt{2}}{2}$

7 a Domain = \mathbb{R}
Range = $(-\pi, \pi)$

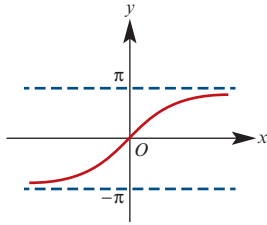

b Domain = $[2, 4]$
Range = $\left[-\frac{\pi}{2}, \frac{\pi}{2}\right]$

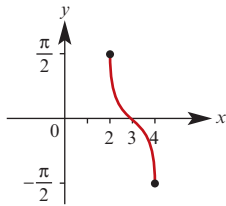

c Domain = $[-1, 0]$
Range = $[0, 3\pi]$

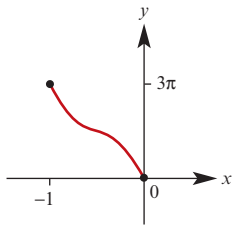

d Domain = $[1, 3]$
Range = $[-\pi, 0]$

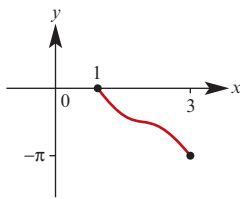

e Domain = \mathbb{R}
Range = $(-\pi, \pi)$

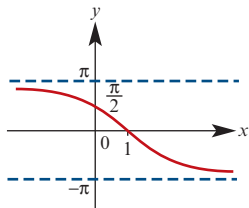

Multiple-choice questions

- 1 C 2 C 3 E 4 D 5 A
6 A 7 E 8 D 9 E 10 E

Extended-response questions

- 1 a i x ii $\sqrt{1-x^2}$ iii $\frac{x}{\sqrt{1-x^2}}$
iv $2x$ v $\sqrt{1-4x^2}$ vi $\frac{2x}{\sqrt{1-4x^2}}$
- b i $2x\sqrt{(1-x^2)} - x\sqrt{1-4x^2}$
ii $\sqrt{(1-4x^2)(1-x^2)} + 2x^2$
iii $\frac{2x\sqrt{1-x^2} - x\sqrt{1-4x^2}}{\sqrt{(1-4x^2)(1-x^2)} + 2x^2}$
iv $\frac{2x\sqrt{1-x^2}}{1-2x^2}$ v $2x\sqrt{1-x^2}$
vi $1-2x^2$
- c $\angle B_2AB_1 = 0.34, 2\alpha = 0.61$

2 a

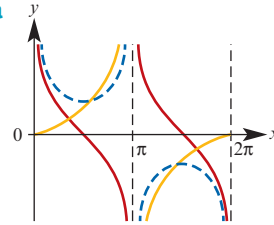

- $y = \operatorname{cosec} x$
— $y = \cot x$
— $y = \operatorname{cosec} x - \cot x$

c $y = \cot\left(\frac{x}{2}\right), y = \operatorname{cosec}(x) + \cot(x)$

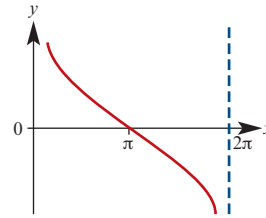

d ii $\cot\left(\frac{\pi}{8}\right) = 1 + \sqrt{2}, \cot\left(\frac{\pi}{12}\right) = 2 + \sqrt{3}$

iii $\frac{1}{\sqrt{4+2\sqrt{2}}}$

e $\cot\left(\frac{\theta}{2}\right) - \cot(4\theta)$

3 a i $100 \sin \theta \cos \theta$

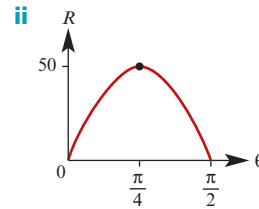

iii 50 iv $\frac{\pi}{4}$

b ii $a = 2000, b = -4000$

iii $V = 2000p - 4000p^2$

iv $0 < p < \frac{1}{2}$

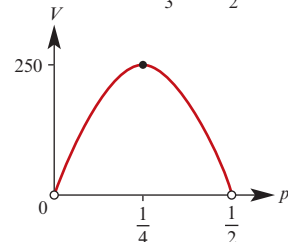
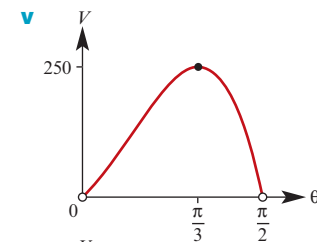

vi Max volume = 250 when $p = \frac{1}{4}, \theta = \frac{\pi}{3}$

c i $V = 1000 \sin^2 \theta$, for $0 < \theta < \frac{\pi}{2}$

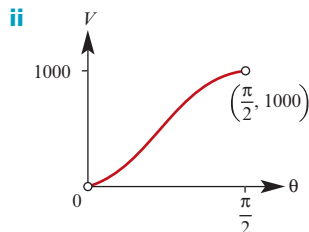

iii V is an increasing function: as the angle theta gets larger, so does the volume of the cuboid

4 b $p = 8 \cos^3 \theta - 4 \cos \theta$

c iii $\frac{\pi}{6}$ **iv** 1

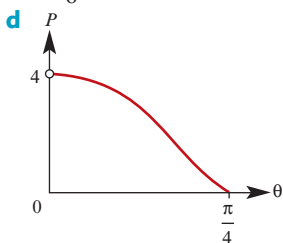

e $\frac{\pi}{4}$

5 a ii $x = \pm \frac{\pi}{4} + n\pi, n \in \mathbb{Z}$

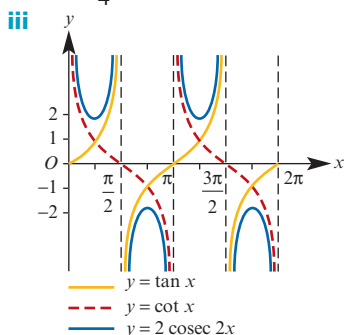

b ii $x = n\pi \pm \frac{\pi}{6}, n \in \mathbb{Z}$

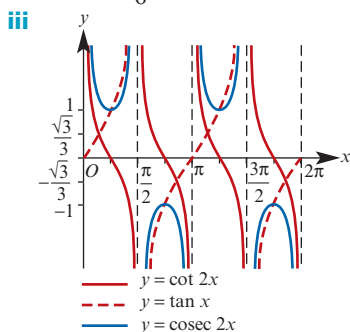

6 a i $\angle BAE = 72^\circ, \angle AEC = 72^\circ, \angle ACE = 72^\circ$

ii 36°

e $\frac{\sqrt{5}-1}{4}$

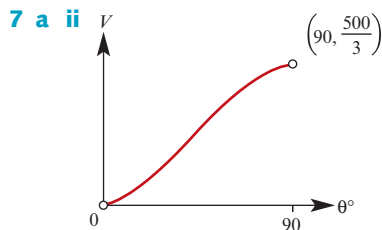

iii V is an increasing function: as the angle theta gets larger, so does the volume of the pyramid

b ii $\theta \in (0, 90)$

iii $V = -\frac{2000}{3}a^2 + \frac{1000}{3}a$

iv $V_{\max} = \frac{125}{3}$ when $\theta = 60$

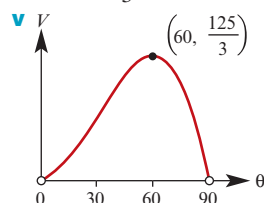

8 a i $V = \frac{500}{3} \cos(\theta^\circ) \sin^2(\theta^\circ)$

ii $V_{\max} = 64.15$ when $\theta = 54.74$

b ii $\theta \in (0, 90)$

c $V_{\max} = 24.69$ when $a = 0.67, \theta = 48.19$

9 c i $x = \frac{a \pm \sqrt{a^2 - 4b(a+b)}}{2}$ **ii** $1 + \sqrt{2}$

d 0.62

e i $\theta = \tan^{-1}\left(\frac{b+1}{5}\right) - \tan^{-1}\left(\frac{b}{5}\right)$

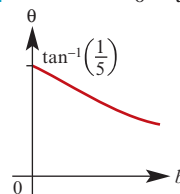

$$\tan \theta = \frac{5}{25 + b + b^2}$$

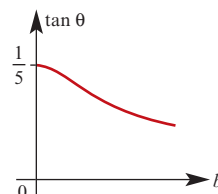

ii $\theta = \tan^{-1}\left(\frac{b+1}{10}\right) - \tan^{-1}\left(\frac{b}{10}\right)$

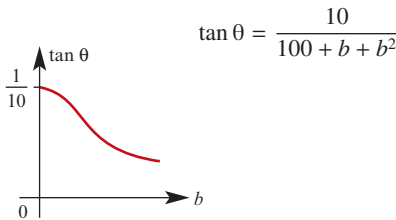
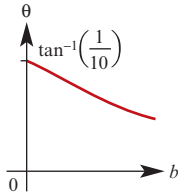

iii $\theta = \tan^{-1}\left(\frac{b+1}{20}\right) - \tan^{-1}\left(\frac{b}{20}\right)$

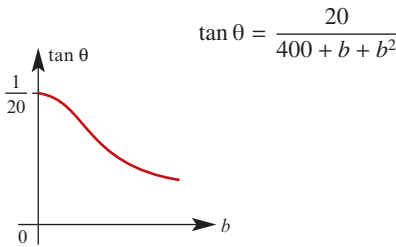
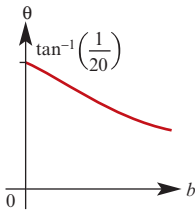

f Graph of $\theta = \tan^{-1}\left(\frac{b+1}{x}\right) - \tan^{-1}\left(\frac{b}{x}\right)$:

- the b -axis is a horizontal asymptote
- domain is $[0, \infty)$; range is $\left(0, \tan^{-1}\left(\frac{1}{x}\right)\right)$
- the θ -axis intercept is $\tan^{-1}\left(\frac{1}{x}\right)$
- θ decreases as b increases

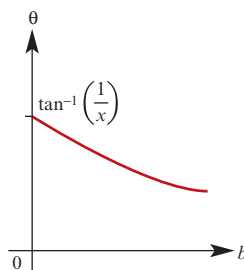

Graph of $\tan \theta = \frac{x}{x^2 + b + b^2}$:

- the b -axis as a horizontal asymptote
- the $\tan \theta$ -axis intercept is $\frac{1}{x}$
- domain is $[0, \infty)$; range is $\left(0, \frac{1}{x}\right]$
- $\tan \theta$ decreases as b increases

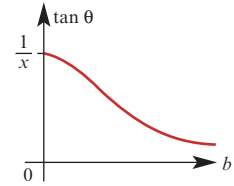

- 10 a Each triangle has a right angle, and angle CAD is common to both triangles
 b $(\cos(2\theta), \sin(2\theta))$
 c i $2 \cos \theta$ ii $2 \sin \theta$

Chapter 4

Short-answer questions

1 a $(-8, 2)$ b $[-3, 1]$ c $(-\infty, -1] \cup [7, \infty)$

2 a i $f \circ g(x) = 4x^2 + 8x - 3$

ii $g \circ f(x) = 16x^2 - 16x + 3$

b Dilation of factor 4 from the x -axis, then translation 3 units down

c Dilation of factor $\frac{1}{4}$ from the y -axis, then translation $\frac{3}{4}$ units to the right

3 a $a = \frac{2}{3}$

b $\text{ran } f = (-\infty, 3]$

c $f^{-1}(x) = \frac{2 + \sqrt{3-x}}{3}$, $\text{dom}(f^{-1}) = (-\infty, 3]$,
 $\text{ran}(f^{-1}) = \left[\frac{2}{3}, \infty\right)$

d

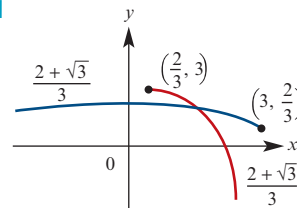

4 $a = \frac{1}{4}$, $b = \frac{3}{2}$

5 a $f^{-1}(x) = \left(\frac{x-1}{3}\right)^3$

b $f^{-1}(x) = \frac{1}{3}\left((x-4)^{\frac{1}{3}} + 2\right)$

c $f^{-1}(x) = \left(\frac{3-x}{2}\right)^{\frac{1}{3}}$

- 6 a** $\frac{2 + \sqrt{3}}{4}$
b i $\sqrt{5} - 1$ **ii** $5 - 2\sqrt{5}$
7 $[-1, 0], \left[\frac{8 - 3\pi}{2}, \frac{8 + 3\pi}{2}\right]$
8 $\left(\frac{3}{4}, 2\right), \left(\frac{9}{4}, 2\right), \left(\frac{15}{4}, 2\right), \left(\frac{21}{4}, 2\right)$
9 $x = \frac{(2n + 1)\pi}{2}, \frac{\pi}{6} + 2n\pi, \frac{5\pi}{6} + 2n\pi$

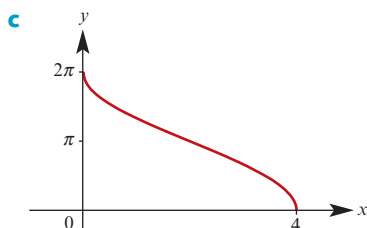
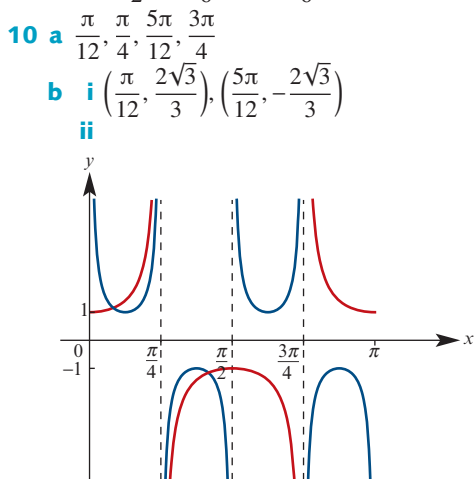

- 11 a** $\left[-\frac{1+d}{c}, \frac{1-d}{c}\right], \left[a - \frac{\pi b}{2}, a + \frac{\pi b}{2}\right]$
b

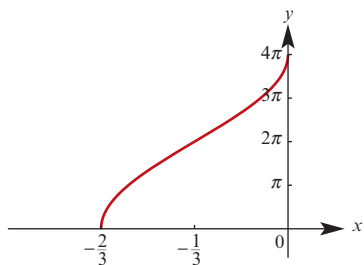

Multiple-choice questions

- 1** A **2** D **3** E **4** E **5** C **6** D
7 E **8** C **9** D **10** B **11** A **12** D
13 D **14** E **15** B **16** B **17** B **18** D
19 D **20** E **21** D **22** E **23** C **24** C
25 E **26** C **27** D **28** B **29** E **30** E
31 E **32** C **33** A **34** D **35** A **36** C
37 E **38** A **39** D

Extended-response questions

- 1 a i** **ii** $[\sqrt{2}, \infty)$

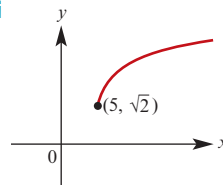

- iii** $f^{-1}: [\sqrt{2}, \infty) \rightarrow \mathbb{R}, f^{-1}(x) = x^2 + 3$

- b i** $p = 3$ **ii** $h^{-1}(x) = x^2 + 3$

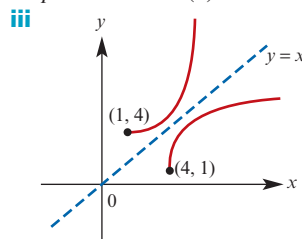

- 2 a** $\text{ran}(f) = (0, 1]$

- b** $\text{ran}(g) = (0, 1]$

- c** $\text{ran}(g) \subseteq \text{dom}(f), f \circ g(x) = \sin\left(\frac{1}{x}\right)$

- d** Not defined as $\text{ran}(f) \not\subseteq \text{dom}(g)$

- e** $g^{-1}(x) = \frac{1}{x}, \text{dom}(g^{-1}) = (0, 1],$
 $\text{ran}(g^{-1}) = [1, \infty)$

- f** $\text{ran}(f) = \text{dom}(g^{-1}), g^{-1} \circ f(x) = \frac{1}{\sin x},$
 $\text{dom}(g^{-1} \circ f) = (0, \pi), \text{ran}(g^{-1} \circ f) = [1, \infty)$

- 3 a**

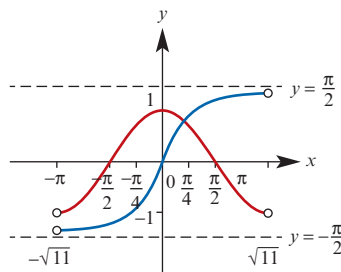

- b i** 0.67 **ii** 0.54

- d** 0.82

- 4 a**

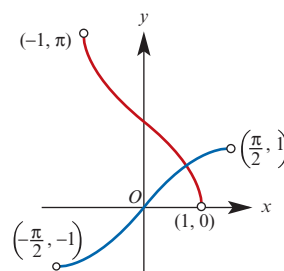

- b i** 0.48 **ii** 0.67

- d** (0.768, 0.695)

- 5 a** $a = 5, d = -10$

- b i** 1.73 m **ii** 8.03 m

- 6** $a = -4, b = \frac{\pi}{9}, c = -\frac{\pi}{3}, d = 8$

Chapter 5

Exercise 5A

1 Magnitude = $\sqrt{5}$

2 $a = 3, b = 2$

3

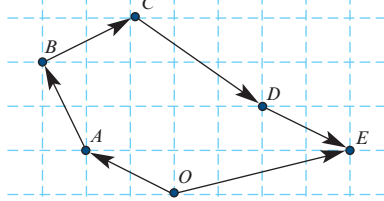

4 a i $2b$ ii $4a$ iii $2a + \frac{3}{2}b$

iv $\frac{1}{2}b - 2a$ v $2a - \frac{3}{2}b$

b i 4 ii 4 iii $\sqrt{13}$

5 a b

6 a 6 b $\frac{9}{2}$ c $\frac{3}{2}$

7 a i $\frac{1}{4}a$ ii $\frac{1}{4}b$ iii $\frac{1}{4}(b - a)$

iv $b - a$

b i $\frac{1}{2}a$ ii $\frac{1}{2}b$ iii $\frac{1}{2}(b - a)$

8 a $a + b$ b $-(a + b + c + d)$ c $-(b + c)$

9 a $b - a$ b $\frac{1}{2}(b - a)$ c $\frac{1}{2}(a + b)$

10 a $\frac{1}{2}(a + b)$

11 a $a + c - b$ b $a + c - 2b$

12 a $-c$ b c c $-\frac{1}{2}a$

d $c + g + \frac{1}{2}a$ e $c + g - \frac{1}{2}a$

13 a i $b - a$ ii $c - d$ iii $b - a = c - d$

b i $c - b$ ii $-\frac{1}{2}a + b - c$

14 a Not linearly dependent

b Not linearly dependent

c Linearly dependent

15 a $k = 3, \ell = \frac{1}{2}$ b $k = \frac{55}{2}, \ell = -10$

16 a i $k(2a - b)$ ii $(2m + 1)a + (4 - 3m)b$

b $k = \frac{11}{4}, m = \frac{9}{4}$

17 a i $\frac{1}{2}(a + b)$ ii $\frac{4}{5}(a + b)$

iii $\frac{1}{5}(4b - a)$ iv $\frac{4}{5}(4b - a)$

b $\vec{RP} = 4\vec{AR}, 1 : 4$ c 4

18 a $x = 0, y = 1$ b $x = -1, y = \frac{7}{3}$

c $x = -\frac{5}{2}, y = 0$

Exercise 5B

1 a i $3i + j$ ii $-2i + 3j$ iii $-3i - 2j$

iv $4i - 3j$

b i $-5i + 2j$ ii $7i - j$ iii $-i + 4j$

c i $\sqrt{10}$ ii $\sqrt{29}$ iii $\sqrt{17}$

2 a $i + 4j$ b $4i + 4j + 2k$ c $6j - 3k$

d $-8i - 8j + 8k$ e $\sqrt{6}$ f 4

3 a i $-5i$ ii $3k$ iii $2j$ iv $5i + 3k$

v $5i + 2j + 3k$ vi $5i + 2j$

vii $-5i - 3k$ viii $2j - 3k$

ix $-5i + 2j - 3k$ x $-5i - 2j + 3k$

xi $5i + 2j - 3k$ xii $5i - 2j - 3k$

b i $\sqrt{34}$ ii $\sqrt{38}$ iii $\sqrt{29}$

c i $\frac{5}{2}i$ ii $\frac{5}{2}i + 2j$ iii $-\frac{5}{2}i + 2j - 3k$

d i $-\frac{4}{3}j$ ii $\frac{2}{3}j$ iii $\frac{2}{3}j + 3k$

iv $5i - \frac{2}{3}j - 3k$ v $\frac{5}{2}i + \frac{4}{3}j - 3k$

e i $\frac{\sqrt{613}}{6}$ ii $\frac{\sqrt{77}}{2}$ iii $\frac{\sqrt{310}}{3}$

4 a $x = 3, y = -\frac{1}{3}$ b $x = 4, y = \frac{2}{5}$

c $x = -\frac{3}{2}, y = 7$

5 a i $-2i + 4j$ ii $3i + 2j$

iii $-2i - 12j$

b $-i + 2j$ c $-8i - 32j$

6 $3i - \frac{7}{2}j + 8k$

7 a i $4i - 2j - 4k$ ii $-5i + 4j + 9k$

iii $2i - j - 2k$ iv $-i - j - 3k$

b i $\sqrt{30}$ ii $\sqrt{67}$

c \vec{AB}, \vec{CD}

8 a i $2i - 3j + 4k$ ii $\frac{4}{5}(2i - 3j + 4k)$

iii $\frac{1}{5}(13i - 7j - 9k)$

b $(\frac{13}{5}, \frac{-7}{5}, \frac{-9}{5})$

10 $\frac{13}{9}$

11 a i $\vec{OA} = 2i + j$ ii $\vec{AB} = -i - 4j$

iii $\vec{BC} = -6i + 5j$ iv $\vec{BD} = 2i + 8j$

b $\vec{BD} = -2\vec{AB}$

c Points A, B and D are collinear

- 12 a** i $\vec{OB} = 2i + 3j + k$
 ii $\vec{AC} = -i - 5j + 8k$
 iii $\vec{BD} = 2i + 2j + 5k$
 iv $\vec{CD} = 4i + 6j + 2k$
b $\vec{CD} = 2(2i + 3j + k) = 2\vec{OB}$
- 13 a** i $\vec{AB} = 2i - j + 2k$
 ii $\vec{BC} = -i + 2j + 3k$
 iii $\vec{CD} = -2i + j - 2k$
 iv $\vec{DA} = i - 2j - 3k$
b Parallelogram
- 14 a** $(-6, 3)$ **b** $(6, 5)$ **c** $(\frac{3}{2}, \frac{-3}{2})$
- 15 a** i $\vec{BC} = 6i + 3j$
 ii $\vec{AD} = (x - 2)i + (y - 1)j$
b $(8, 4)$
- 16 a** $(1.5, 1.5, 4)$
b $(\frac{x_1 + x_2}{2}, \frac{y_1 + y_2}{2}, \frac{z_1 + z_2}{2})$
- 17** $(\frac{17}{5}, \frac{8}{5}, -3)$ **18** $(\frac{17}{2}, 3)$
- 19** $(-11, \frac{-11}{3})$
- 21 a** i $i + j$ ii $-i - 6j$ iii $-i - 15j$
b $k = \frac{19}{8}, \ell = \frac{-1}{4}$
- 22 a** i $2i + 4j - 9k$ ii $14i - 8j + 3k$
 iii $5.7i - 0.3j - 1.6k$
b There are no values for k and ℓ such that $ka + \ell b = c$
- 23 a** i $\sqrt{29}$ ii $\sqrt{13}$ iii $\sqrt{97}$ iv $\sqrt{19}$
b i 21.80° anticlockwise
 ii 23.96° clockwise iii 46.51°
- 24 a** $-3.42i + 9.40j$ **b** $-2.91i - 7.99j$
c $4.60i + 3.86j$ **d** $2.50i - 4.33j$
- 25 a** $-6.43i + 1.74j + 7.46k$
b $5.14i + 4.64j - 4k$
c $6.13i - 2.39j - 2.39k$
d $-6.26i + 9.77j + 3.07k$
- 27 a** $|\vec{AB}| = |\vec{AC}| = 3$ **b** $\vec{OM} = -i + 3j + 4k$
c $\vec{AM} = i + 2j - k$ **d** $3\sqrt{2}$
- 28 a** $5i + 5j$ **b** $\frac{1}{2}(5i + 5j)$
c $\frac{5}{2}i + \frac{5}{2}j + 3k$ **d** $\frac{-5}{2}i - \frac{5}{2}j + 3k$
e $\frac{\sqrt{86}}{2}$
- 29 a** $\vec{MN} = \frac{1}{2}b - \frac{1}{2}a$
b $\vec{MN} \parallel \vec{AB}, MN = \frac{1}{2}AB$
- 30 a** $\frac{\sqrt{3}}{2}i - \frac{1}{2}j$ **b** $\frac{3\sqrt{3}}{2}i - \frac{3}{2}j$
c $\frac{3\sqrt{3}}{2}i + \frac{7}{2}j$ **d** $\sqrt{19}$ km

- 31 a** $\vec{OA} = 50k$
b i $-80i + 20j - 10k$ ii $10\sqrt{69}$ m
c $-80i + 620j + 100k$
- 32 a** 2.66 km
b i $-0.5i - j + 0.1k$ ii 1.12 km
c $-0.6i - 0.8j$
- 33 a** $-100\sqrt{2}i + 100\sqrt{2}j$ **b** $50j$
c $-100\sqrt{2}i + (50 + 100\sqrt{2})j$ **d** $30k$
e $-100\sqrt{2}i + (50 + 100\sqrt{2})j + 30k$
- 34 a** $\vec{OP} = 50\sqrt{2}i + 50\sqrt{2}j$
b i $(50\sqrt{2} - 100)i + 50\sqrt{2}j$ ii 337.5°
- 35** $m = \frac{2n - 9}{n + 3}$

- 36 a** $-i - 8j + 16k$ **b** $\frac{3}{4}$
- 37 a** $(3m + 1)i - j + (1 - 3m)k$ **b** -5

Exercise 5C

- 1 a** 66 **b** 22 **c** 6 **d** 11 **e** 25
f 86 **g** -43
- 2 a** 14 **b** 13 **c** 0 **d** -8 **e** 14
- 3 a** 21 **b** -21
- 4 a** $a \cdot a + 4a \cdot b + 4b \cdot b$ **b** $4a \cdot b$
c $a \cdot a - b \cdot b$ **d** $|a|$
- 5 a** -4 **b** 5 **c** 5 **d** -6 or 1
- 6 a** $\vec{AB} = -2i - j - 2k$ **b** $|\vec{AB}| = 3$
c 105.8°
- 7** $\sqrt{66}$
- 8 a** i c ii $a + c$ iii $c - a$
- 9** d and f ; a and e ; b and c
- 10 a** $\vec{AP} = -a + qb$ **b** $q = \frac{13}{15}$
c $(\frac{26}{15}, \frac{13}{3}, \frac{-13}{15})$
- 11** $x = 1, y = -3$
- 12 a** 2.45 **b** 1.11 **c** 0.580 **d** 2.01
- 14 a** $\vec{OM} = \frac{3}{2}i + j$ **b** 36.81° **c** 111.85°
- 15 a** i $-i + 3j$ ii $3j - 2k$
b 37.87° **c** 31.00°
- 16 a** i $\vec{OM} = \frac{1}{2}(4i + 5j)$ ii $\vec{ON} = \frac{1}{2}(2i + 7k)$
b 80.12° **c** 99.88°
- 17** 69.71°

Exercise 5D

- 1 a** $\frac{\sqrt{11}}{11}(i + 3j - k)$ **b** $\frac{1}{3}(i + 2j + 2k)$
c $\frac{\sqrt{10}}{10}(-j + 3k)$
- 2 a** i $\frac{\sqrt{26}}{26}(3i + 4j - k)$ ii $\sqrt{3}(i - j - k)$
b $\frac{\sqrt{78}}{26}(3i + 4j - k)$

- 3 a** **i** $\frac{1}{3}(2i - 2j - k)$ **ii** $\frac{1}{5}(3i + 4k)$
b $\frac{\sqrt{510}}{510}(19i - 10j + 7k)$
- 4 a** $\frac{-11}{18}(i - 4j + k)$ **b** $\frac{-1}{9}(i - 4j + k)$
c $\frac{13}{17}(4i - k)$
- 5 a** **2** **b** $\frac{\sqrt{5}}{5}$ **c** $\frac{2\sqrt{21}}{7}$ **d** $\frac{-(1 + 4\sqrt{5})\sqrt{17}}{17}$
- 6 a** $\frac{9}{26}(5i - k)$, $\frac{1}{26}(7i + 26j + 35k)$
b $\frac{3}{2}(i + k)$, $\frac{3}{2}i + j - \frac{3}{2}k$
c $-\frac{1}{9}(2i + 2j - k)$, $-\frac{7}{9}i + \frac{11}{9}j + \frac{8}{9}k$
- 7 a** $j + k$ **b** $\frac{1}{3}(i + 2j - 2k)$
- 8 a** $i - j - k$ **b** $3i + 2j + k$ **c** $\sqrt{14}$
- 9 a** **i** $i - j - 2k$ **ii** $i - 5j$
b $\frac{3}{13}(i - 5j)$ **c** $\frac{2}{13}\sqrt{195}$ **d** $\sqrt{30}$
- 10 b** **i** $\frac{2}{7}(i - 3j - 2k)$ **ii** $\frac{1}{3}(5i + j + k)$
c $\frac{1}{21}(i + 11j - 16k)$

Exercise 5E

- 1 a** $\frac{1}{3}a + \frac{2}{3}b$ **b** $\frac{2}{5}a + \frac{3}{5}b$
- 2 a** $\frac{5}{2}i - j + \frac{5}{2}k$ **b** $\frac{5}{3}i - \frac{8}{3}j$
c $\frac{10}{3}i + \frac{2}{3}j + 5k$
- 3 b** 2 : 1
- 4 a** $\frac{a+x}{2}i + \frac{y}{2}j$ **b** $x^2 + y^2 = a^2$
- 5 b** 1 : 5
- 6 a** $\vec{OB} = -i + 7j$ **b** $\vec{OD} = -2i + \frac{17}{3}j$
c $\lambda = \frac{2}{5}$
- 7 b** **i** $\vec{OP} = 2i + j + k$
ii $\vec{OP} = \frac{18}{11}i + \frac{15}{11}j - \frac{1}{11}k$
iii $\vec{OP} = \frac{7}{4}i + \frac{5}{4}j + \frac{1}{4}k$

Exercise 5F

- 12 a** **i** $\frac{1}{2}(b - a)$ **ii** $\frac{1}{2}(a + b)$
b $\frac{1}{2}(a \cdot a + b \cdot b)$
- 13 c** 3 : 1
- 14 a** **i** $\frac{1}{3}(a + 2b)$ **ii** $a + 2b$ **iii** $2b$

- 15 a** $s = r + t$
b $u = \frac{1}{2}(r + s)$, $v = \frac{1}{2}(s + t)$
- 16 b** $\vec{AB} = i - 3j$, $\vec{DC} = i - j$
c $4i + 2j$ **e** $4j$
- 18** $\frac{2}{3}b - \frac{5}{12}a$
- 19 b** $\lambda = \frac{k+2}{2}$, $\mu = \frac{k+2}{2}$
c $\lambda = \frac{3}{2}$, $\mu = \frac{3}{2}$
- 20 a** $\vec{OG} = b + d + e$, $\vec{DF} = b - d + e$,
 $\vec{BH} = -b + d + e$, $\vec{CE} = -b - d + e$
b $|\vec{OG}|^2 = |b|^2 + |d|^2 + |e|^2$
 $+ 2(b \cdot d + b \cdot e + d \cdot e)$
 $|\vec{DF}|^2 = |b|^2 + |d|^2 + |e|^2$
 $+ 2(-b \cdot d + b \cdot e - d \cdot e)$
 $|\vec{BH}|^2 = |b|^2 + |d|^2 + |e|^2$
 $+ 2(-b \cdot d - b \cdot e + d \cdot e)$
 $|\vec{CE}|^2 = |b|^2 + |d|^2 + |e|^2$
 $+ 2(b \cdot d - b \cdot e - d \cdot e)$
- 21 b** $12r^2$

Chapter 5 review

Short-answer questions

- 1 a** $2i - j + k$ **b** $\frac{\sqrt{2}}{3}$
- 2 a** **i** $\frac{3}{7}(-3i + 2j + 6k)$ **ii** $\frac{1}{7}(6i - 11j - 12k)$
- 3 a** $x = 5$ **b** $y = 2.8$, $z = -4.4$
- 4 a** $\cos \theta = \frac{1}{3}$ **b** 6
- 5 a** $\frac{1}{9}(43i - 46j + 20k)$ **b** $\frac{485}{549}(3i - 6j + 4k)$
- 6 a** **i** $(2 - 3t)j + (-3 - 2t)k$
ii $(-2 - 3t)j + (3 - 2t)k$
b ± 1
- 7 a** **i** $2\sqrt{17}$ **ii** $4\sqrt{3}$ **iii** -40
b $\cos^{-1}\left(\frac{5\sqrt{51}}{51}\right)$
- 8 a** $3i - \frac{3}{2}j + k$ **b** $i - \frac{1}{2}j + 4k$ **c** $\frac{8\sqrt{5}}{21}$
- 9 a** $34 - 4p$ **b** 8.5 **c** $\frac{5}{13}$
- 10** -6.5
- 11** $\lambda = \frac{3}{2}$, $\mu = -\frac{3}{2}$
- 12** $AB \parallel DC$, $AB : CD = 1 : 2$
- 13** $\frac{\sqrt{19}}{5}$
- 14 a** $(-1, 10)$ **b** $h = 3$, $k = -2$
- 15 a** $2c$, $2c - a$ **b** $\frac{1}{2}a + c$ **c** 1.5

- 16 $h = \frac{2}{3}, k = \frac{3}{4}$
 17 $3(i + j)$
 18 **a** $c - a$
 19 **a** $\frac{1}{3}c$ **ii** $\frac{2}{3}a + \frac{1}{3}b$ **iii** $\frac{2}{3}a + \frac{1}{3}b - \frac{1}{3}c$
 20 **a** $\frac{1}{4}a + \frac{3}{4}b$
 b $\frac{\lambda}{4}a + \left(\frac{3\lambda}{4} - 1\right)b$ **ii** $\frac{4}{3}$
 21 $m = \frac{3(n-6)}{n+2}$
 22 **a** $v = \frac{6}{5}i + j - \frac{2}{5}k$

Multiple-choice questions

- 1 C 2 D 3 B 4 B 5 C
 6 C 7 E 8 E 9 D 10 B
 11 C 12 B 13 D

Extended-response questions

- 1 **a** **i** $i + j + k$ **ii** $\sqrt{3}$
 b **i** $(\lambda - 0.5)i + (\lambda - 1)j + (\lambda - 0.5)k$
 ii $\lambda = \frac{2}{3}, \vec{OQ} = \frac{1}{3}(8i + 11j + 5k)$
 c $5i + 6j + 4k$
 2 **a** **i** $|\vec{OA}| = \sqrt{14}, |\vec{OB}| = \sqrt{14}$ **ii** $i - 5j$
 b **i** $\frac{1}{2}(5i + j + 2k)$
 c $5i + j + 2k$
 e **i** $5i + j - 13k$ or $-5i - j + 13k$
 iii The vector is perpendicular to the plane containing $OACB$
 3 **a** $\vec{OX} = 7i + 4j + 3k, \vec{OY} = 2i + 4j + 3k,$
 $\vec{OZ} = 6i + 4j, \vec{OD} = 6i + 3k, |\vec{OD}| = 3\sqrt{5},$
 $|\vec{OY}| = \sqrt{29}$
 b 48.27°
 c **i** $\left(\frac{5\lambda}{\lambda+1} + 1\right)i + 4j$ **ii** $-\frac{1}{6}$
 4 **a** **i** $b - a$ **ii** $c - b$ **iii** $a - c$
 iv $\frac{1}{2}(b + c)$ **v** $\frac{1}{2}(a + c)$ **vi** $\frac{1}{2}(a + b)$
 5 **a** $\frac{1}{3}b + \frac{2}{3}c$
 c **ii** $5 : 1$
 d $1 : 3$
 6 **a** **i** $\frac{1}{2}(a + b)$ **ii** $-\frac{1}{2}a + \left(\lambda - \frac{1}{2}\right)b$
 7 **a** **i** $12(1 - a)$ **ii** 1
 b **i** $x - 4y + 2 = 0$ **ii** $x = -2, y = 0$
 c **i** $j + 4k$ **ii** $i - 12j + 5k$
 iii $3i - 11j + 7k$
 d X has height 5 units; Y has height 7 units
 8 **a** **i** $\frac{3}{4}c$ **ii** $\frac{2}{5}a + \frac{3}{5}c$ **iii** $-a + \frac{3}{4}c$
 b $\mu = \frac{5}{6}, \lambda = \frac{2}{3}$

- 9 **a** $b = qi - pj, c = -qi + pj$
 b **i** $\vec{AB} = -(x+1)i - yj, \vec{AC} = (1-x)i - yj$
 ii $\vec{AE} = yi + (1-x)j, \vec{AF} = -yi + (x+1)j$
 10 **a** **i** $\vec{BC} = mv, \vec{BE} = nv, \vec{CA} = mw, \vec{CF} = nw$
 ii $|\vec{AE}| = \sqrt{m^2 - mn + n^2},$
 $|\vec{FB}| = \sqrt{m^2 - mn + n^2}$
 11 **a** $\vec{CF} = \frac{1}{2}a - c, \vec{OE} = \frac{1}{2}(a + c)$
 b **ii** 60°
 c **ii** HX is parallel to EX ; KX is parallel to FX ; HK is parallel to EF
 12 **a** $\vec{OA} = -2(i + j), \vec{OB} = 2(i - j),$
 $\vec{OC} = 2(i + j), \vec{OD} = -2(i - j)$
 b $\vec{PM} = i + 3j + hk, \vec{QN} = -3i - j + hk$
 c $\vec{OX} = \frac{1}{2}i - \frac{1}{2}j + \frac{h}{2}k$

- d** **i** $\sqrt{2}$ **ii** 71°
 e **ii** $\sqrt{6}$
 13 **a** **i** $\vec{OM} = \frac{a}{2}j$ **ii** $\vec{MC} = ai + \frac{a}{2}j$
 b $\vec{MP} = a\lambda i + \frac{a\lambda}{2}j,$
 $\vec{BP} = a(\lambda - 1)i + \frac{a}{2}(\lambda + 1)j,$
 $\vec{OP} = a\lambda i + \frac{a}{2}(\lambda + 1)j$
 c **i** $\lambda = \frac{3}{5}, |\vec{BP}| = \frac{2\sqrt{5}a}{5}, |\vec{OP}| = a, |\vec{OB}| = a$
 ii $\frac{\sqrt{5}}{5}$
 d $\lambda = -1$ and $\lambda = \frac{3}{5}$

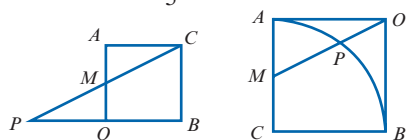

e $\vec{OY} = \frac{14}{15}ai + \frac{29}{30}aj + \frac{1}{6}ak$

Chapter 6

Exercise 6A

- 1 **a** Yes **b** Yes **c** No
 2 **a** $r = i + (1 + 2t)j$
 b $r = i - 3k + t(i + j + 2k)$
 c $r = 2i - j + 2k + t(-i + 2j - k)$
 d $r = 2i - 2j + k + t(-4i + 3j)$
 3 **a** $r = 3i + j + t(-5i + j)$
 b $r = -i + 5j + t(3i - 6j)$
 c $r = i + 2j + 3k + t(i - 2j - 4k)$
 d $r = i - 4j + t(i + 7j + k)$
 4 **a** $r = 2i + j + t(-3i + j)$
 b $r = 2i + j + t(i + 3j)$
 5 **a** $r = t(2j - k)$ **b** $r = t(j + 2k)$

- 6 a** $r = 2i + j + t(-3i + 2j)$
b i No **ii** No **iii** Yes
7 a $r = j + k + t(3i + j - k)$
c $m = \frac{-5}{3}, n = \frac{-4}{3}$
8 a $4i + 3j$ **b** $r = -i + j + t(4i + 3j)$
c $(-\frac{7}{3}, 0), (0, \frac{7}{4})$
9 a $x = 2 - 3t, y = 5 + t, z = 4 - 2t;$
 $\frac{2-x}{3} = y - 5 = \frac{4-z}{2}$
b $x = 2t, y = 2 + t, z = -1 + 4t;$
 $\frac{x}{2} = y - 2 = \frac{z+1}{4}$

- 10 a** $\frac{11\sqrt{114}}{38}$ **b** $\frac{\sqrt{23} \ 123}{19}$
11 c $t \in [-3, 2]$
12 $(\frac{13}{5}, \frac{23}{5}, 0)$
13 $r = -i - 3j - 3k + t(2i + j + 3k); \sqrt{5}$
14 $\sqrt{17}$ **15** 3
16 $(\frac{7}{3}, \frac{2}{3}, \frac{8}{3})$ **17** $r = (t - 2)i + 2j + k$
18 $\frac{\sqrt{165}}{3}$
19 $(-1, -1, 3), (-5, 1, 7)$ **20** $(2, 6, -4), (5, 0, 2)$
21 a $(1 + t)i + (-4 + 2t)j + (1 - t)k$
b $\sqrt{18 - 16t + 6t^2}$ **c** $\frac{\sqrt{66}}{3}$ **d** $\frac{\sqrt{786}}{6}$

Exercise 6B

- 1** $\frac{17}{2}i + \frac{9}{4}j$
2 $(-1, 2, 3)$
4 a i No **ii** No **iii** No **iv** $(-7, -6)$
b i No **ii** Yes **iii** No **iv** $(-1, 1)$
c i Yes **ii** No **iii** Yes
d i Yes **ii** No **iii** No **iv** None
e i No **ii** Yes **iii** No **iv** $(3, 1, -2)$
f i No **ii** No **iii** No **iv** None
g i No **ii** No **iii** No **iv** $(3, 0, -1)$
h i Yes **ii** No **iii** Yes
i i No **ii** No **iii** No **iv** $(0, 1, -2)$
j i Yes **ii** No **iii** Yes
5 a $(1, 2, -1)$ **b** None **c** None **d** None
6 a 25.21° **b** 0°
7 a 30°
8 a $(3, 3, 1)$ **b** $\frac{1}{\sqrt{15}}$
9 \blacksquare Lines ℓ_1 and ℓ_2 do not intersect
 \blacksquare Lines ℓ_1 and ℓ_3 intersect at $(2, 3, -1)$
 \blacksquare Lines ℓ_2 and ℓ_3 intersect at $(4, -5, -1)$

Exercise 6C

- 1 a** $-3i + 4j + 19k$ **b** $i - 7j - 4k$
c $i - j$ **d** $i + 2k$
2 a $-9i - 26j - 12k$ **b** $2j + k$
c $2j + k$ **d** $i - 2k$
3 a $a \times b$ **b** 0 **c** $2(a \times b)$
d $(a \times c) \cdot b$ **e** 0 **f** 0
4 $\frac{\sqrt{10}}{6}(4i - 5j - 7k)$
6 1
7 $\frac{\sqrt{374}}{2}$

Exercise 6D

- 1 a** $r \cdot (i + j + k) = 3, x + y + z = 3$
b $r \cdot (i - 2k) = 3, x - 2z = 3$
c $r \cdot (2i + 3j - k) = 0, 2x + 3y - z = 0$
d $r \cdot (i + 3j - k) = -8, x + 3y - z = -8$
2 $\frac{1}{\sqrt{170}}(-12i + 5j - k), r \cdot (-12i + 5j - k) = 2$
3 $r \cdot (i - j - 3k) = -1, x - y - 3z = -1$
4 a $5i + 4j + 13k$
b $r = -3i + j + k + t(5i + 4j + 13k)$
5 $\frac{1}{\sqrt{77}}(-6i + 5j + 4k), r \cdot (-6i + 5j + 4k) = 11$
8 a $x = 0$ **b** $x = 6$ **c** $x = 3$ **d** $x = 4$
9 $6x + 2y + z = 10$ **10** $x - 2y + 8z = 7$
11 $5x - 3y + 2z = 27$ **12** $13x + 7y + 9z = 61$
13 $-3x + 8y + 7z = 41$

Exercise 6E

- 1 a** 2 **b** $\frac{22}{9}$
2 $\frac{8}{3}$
3 a $(-1, -9, 7)$ **b** 7.82°
4 a 80.41° **b** $r = 22j + 14k + t(i - 5j - 3k)$
5 a $7i + j + 5k$ **b** $i + 3j - 5k$
c 72.98°
6 a $(2, -2, -1), 29.50^\circ$
b $(\frac{7}{2}, -\frac{3}{2}, -\frac{5}{2}), 32.98^\circ$
c $(\frac{1}{2}, \frac{3}{2}, -\frac{7}{2}), 79.98^\circ$ **d** $(-7, 4, -3), 7.45^\circ$
7 a $r \cdot (i - 2j + 6k) = -9$ **b** $\frac{9}{\sqrt{41}}$
8 a $\frac{7}{3}$ **b** $\frac{1}{3}(2i - j - 2k)$ **c** 1 **d** $\frac{4}{3}$
9 $\frac{5}{3}$
10 a $(5, -1, -1)$ **b** 25.7°
11 a $x + y + z = 4$ **b** $2\sqrt{3}$
c $\frac{4}{3}(i + j + k)$

- 12 a** 88.18°
b $r = -\frac{5}{2}j - 9k + t\left(i + \frac{19}{2}j + 30k\right)$
- 13 a** $i - 5j - 3k$ **b** $2i + 3j + 7k$ **c** 43.12°
- 14 a** $-6i - 4j + k$
b $r = 2i + j - 2k + t(-6i - 4j + k)$
- 15** 2 **16** $\frac{3}{\sqrt{2}}$ **17** $\frac{4}{\sqrt{5}}$

Exercise 6F

- 1 a** $(x+1)^2 + (y-3)^2 + (z-2)^2 = 4$
b $|r - (-i + 3j + 2k)| = 2$
- 2 a** $(x+1)^2 + (y+3)^2 + (z-1)^2 = 16$
b $|r - (-i - 3j + k)| = 4$
- 3** $\left(\frac{8}{\sqrt{17}}, \frac{12}{\sqrt{17}}, -\frac{8}{\sqrt{17}}\right)$
- 4** $\left(1 + \frac{\sqrt{22}}{2}, 1 + \frac{\sqrt{22}}{2}, 1 - \sqrt{22}\right),$
 $\left(1 - \frac{\sqrt{22}}{2}, 1 - \frac{\sqrt{22}}{2}, 1 + \sqrt{22}\right)$
- 5** $(2 + 3\sqrt{2}, 3 + 3\sqrt{2}, 4), (2 - 3\sqrt{2}, 3 - 3\sqrt{2}, 4)$
- 6 a** $(0, 0, 3), 3\sqrt{3}$ **b** $(3, 0, 0), 3\sqrt{3}$
c $(0, 0, 0), 6$
- 7** $(1, 2, -4), 2$
- 8 a** $(x-1)^2 + y^2 + (z+1)^2 = 16$
b $(x-1)^2 + (y+3)^2 + (z-2)^2 = 14$
c $(x-3)^2 + (y+2)^2 + (z-4)^2 = 33$
d $x^2 + y^2 + z^2 = 9$
- 9 a** $(0, 0, 0), (4, 0, 0), (0, 6, 0), (0, 0, 8)$
b $r = 2i + 3j + 4k + t(2i - 3j - 4k)$
c $2x - 3y - 4z = 8$

Chapter 6 review

Short-answer questions

- 1** $4i - k$ **3** $4x + 5y + 6z = 32$
- 4** $r = (t-2)i + 2j + k$ **5** $\left(\frac{7}{3}, \frac{2}{3}, \frac{8}{3}\right)$
- 6** $\frac{\sqrt{165}}{3}$ **7** $(-1, -1, 4)$
- 8** $2i + 7j + 5k$
- 9** $r = 5i + 6k + t(6i + 3j + 9k); (1, -2, 0)$
- 10** $\frac{\sqrt{3}}{2}$ **11** $2x - 8y + 5z = 18$
- 12** $12x + 8y + 20z = 16$
- 13 a** $r \cdot (i + 10j + 6k) = 19$
b $x + 10y + 6z = 19$
- 14 a** $x - 2y + z = 0$ **b** $\frac{\sqrt{6}}{2}$ **c** $\left(0, \frac{4}{3}, \frac{8}{3}\right)$
- 15** $(1, -2, 1)$ or $(1, 1, -2)$

Multiple-choice questions

- 1** C **2** D **3** D **4** D **5** D
6 C **7** A **8** D **9** E **10** C

Extended-response questions

- 1 a** $(3, -1, 2)$ **b** $\frac{\sqrt{30}}{3}$
- 2 c** $\sqrt{30}$ **d** 47.73° **e** $k = 2$ or $k = 80$
- 3 c** $r = 3i + 2j + k + t(5i - 7j + k)$
d $(13, -12, 3), 10\sqrt{3}$
- 5 a** $i + 4j - 4k$ **b** $\sqrt{19}$
c $8x - 11y - 9z = 0$ **d** 29.9°

Chapter 7

Exercise 7A

- 1 a** $x = 4, y = -3$ **b** $x = -\frac{3}{2}, y = \frac{1}{2}$
c $x = \frac{51}{38}, y = -\frac{31}{38}$ **d** $x = \frac{37}{10}, y = \frac{7}{5}$
- 2 a** One solution
b Infinitely many solutions **c** No solution
- 3** Their graphs are parallel straight lines that do not coincide
- 4** $x = 6 + \lambda, y = \lambda$ for $\lambda \in \mathbb{R}$
- 5 a** $m = -5$ **b** $m = 3$
- 6** $m = 9$
- 7 a i** $m = -2$ **ii** $m = 4$
b $x = \frac{4}{m+2}, y = \frac{2(m+4)}{m+2}$
- 8 a** $x = 2, y = 0, k \neq -\frac{3}{2}$ **b** $k = -\frac{3}{2}$
- 9 a** $b \neq 10$ **b** $b = 10, c = 8$
c $b = 10, c \neq 8$
- 10 a ii** Infinitely many solutions for $b = 8$
iii No solutions for $b \neq 8$
iv If $b = 8$, then the solutions are $x = 4 - \lambda,$
 $y = \lambda$ for $\lambda \in \mathbb{R}$
- b i** Unique solution for all $b \in \mathbb{R}$
iv Solution is $x = b - 4, y = 8 - b$
- c i** Unique solution for $b \neq 1$
iii No solution for $b = 1$
iv If $b \neq 1$, then $x = \frac{4}{b-1}, y = \frac{4b-8}{b-1}$
- Exercise 7B**
- 1 a** $x = 2, y = 3, z = 1$ **b** $x = -3, y = 5, z = 2$
c $x = 5, y = 0, z = 7$ **d** $x = 6, y = 5, z = 1$
- 2 a** $y = 4z - 2$
b $x = 8 - 5\lambda, y = 4\lambda - 2, z = \lambda$
- 3 a** $x = \lambda - 1, y = \lambda, z = 5$
b $x = \lambda + 3, y = 3\lambda, z = \lambda$
c $x = \frac{14-3\lambda}{6}, y = \frac{10-3\lambda}{6}, z = \lambda$
- 4 a** $-y + 5z = 15, -y + 5z = 15$
b The two equations are the same
c $y = 5\lambda - 15$ **d** $x = 43 - 13\lambda$

5 $w = \frac{\lambda - 2}{2}, x = \frac{26 - 3\lambda}{4}, y = \frac{-3(\lambda + 2)}{4}, z = \lambda$
for $\lambda \in \mathbb{R}; w = 6, x = -4, y = -12, z = 14$

6 a $x = 1, y = 2, z = 3$

b $x = -\frac{5}{3}, y = \frac{-5 + 3\lambda}{3}, z = \lambda$

c $x = \frac{2 - 3\lambda}{2}, y = -2(\lambda - 1), z = \lambda$

Exercise 7C

1 a $x = -\frac{7}{5}, y = \frac{11}{5}, z = -2$

b $x = -\frac{1}{2}, y = 2, z = -\frac{3}{2}$

c $x = \frac{115}{13}, y = -\frac{29}{13}, z = \frac{44}{13}$

2 a $\left[\begin{array}{ccc|c} 1 & 0 & 1 & 3 \\ 0 & 1 & -3 & 2 \\ 0 & 0 & 0 & 0 \end{array} \right]$
 $x = 3 - \lambda, y = 2 + 3\lambda, z = \lambda$ for $\lambda \in \mathbb{R}$

b $\left[\begin{array}{ccc|c} 1 & 0 & -2 & 4 \\ 0 & 1 & 1 & 3 \\ 0 & 0 & 0 & 0 \end{array} \right]$
 $x = 4 + 2\lambda, y = 3 - \lambda, z = \lambda$ for $\lambda \in \mathbb{R}$

c $\left[\begin{array}{ccc|c} 1 & 0 & \frac{3}{2} & 1 \\ 0 & 1 & 2 & 2 \\ 0 & 0 & 0 & 0 \end{array} \right]$
 $x = 1 - \frac{3}{2}\lambda, y = 2 - 2\lambda, z = \lambda$ for $\lambda \in \mathbb{R}$

3 $\left[\begin{array}{ccc|c} 1 & 0 & -\frac{1}{2} & 0 \\ 0 & 1 & \frac{1}{2} & 0 \\ 0 & 0 & 0 & 1 \end{array} \right]$
No solutions, as row 3 represents the equation $0x + 0y + 0z = 1$

4 a $x = 1, y = 2, z = 4$

b $x = 3, y = 0, z = -2$

c $x = -\frac{100}{317}, y = \frac{-248}{317}, z = \frac{335}{317}$

d No solutions

5 a ■ Unique solution for $a \in \mathbb{R} \setminus \{-4, 4\}$

■ Infinitely many solutions for $a = 4$

■ No solutions for $a = -4$

b ■ If $a \in \mathbb{R} \setminus \{-4, 4\}$, then the solution is

$$x = \frac{25 + 8a}{28 + 7a}, y = \frac{2(27 + 5a)}{7(4 + a)}, z = \frac{1}{4 + a}$$

■ If $a = 4$, then the solutions are

$$x = \frac{8 - 7\lambda}{7}, y = \frac{10 + 14\lambda}{7}, z = \lambda, \lambda \in \mathbb{R}$$

6 a Unique solution for $a \in \mathbb{R} \setminus \{-2, 2\}$

Infinitely many solutions for $a = 2$

No solutions for $a = -2$

b Unique solution

$$x = 2, y = \frac{3 + 2a}{2 + a}, z = \lambda, \lambda \in \mathbb{R}$$

Infinitely many solutions

$$x = 2, y = 2 - \lambda, z = \lambda$$

7 a $r = (6 - \lambda)i - \frac{1}{3}(2 + \lambda)j + \lambda k$

b $r = \frac{1}{11}(26 - 2\lambda)i + \frac{1}{11}(17 - 3\lambda)j + \lambda k$

8 a Infinitely many solutions for $a = 6$

b The three planes intersect along a line

c The first two planes intersect along a line in the plane $3x - 2y + 2z = 6$. (Add the first two equations.) The third plane is parallel to this plane, and coincides only if $a = 6$.

9 $\left[\begin{array}{ccc|c} 1 & -3 & 0 & 0 \\ 0 & 0 & 1 & 0 \\ 0 & 0 & 0 & 1 \end{array} \right]$

No solutions, as row 3 represents the equation $0x + 0y + 0z = 1$

10 a $x = -\lambda, y = \lambda, z = 0, w = \lambda$

b $x = -\frac{11\lambda}{39}, y = -\frac{4\lambda}{39}, z = -\frac{5\lambda}{39}, w = \lambda$

c $x = -\frac{\lambda}{5}, y = \lambda, z = 0, w = 0$

11 $9x + y - 5z - 16 = 0$

12 $x + 9y - 5z - 26 = 0$

Chapter 7 review

Short-answer questions

1 $k \in \mathbb{R} \setminus \{-\frac{3}{2}\}$

2 $a \in \mathbb{R} \setminus \{6\}$

3 a $a = -1$

b $a = 2$

c $a \in \mathbb{R} \setminus \{-1, 2\}$

4 $y = 3x^2 - 8x + 12$

6 a $a \in \mathbb{R} \setminus \{-2, 2, 3\}$

b $a = -2$ or 2

c $a = 3$

7 a $r = 2i + j + \lambda(j + k)$

b $(2, -1, -2), (2, 1, 1)$

Multiple-choice questions

1 D

2 A

3 B

4 C

5 D

6 A

7 E

8 A

9 A

10 D

Extended-response questions

1 a $5x + 6y + 10z = 310$

$$3x + 4y + 5z = 175$$

$$2x + 6y + 5z = 175$$

b $\left[\begin{array}{ccc|c} 5 & 6 & 10 & 310 \\ 3 & 4 & 5 & 175 \\ 2 & 6 & 5 & 175 \end{array} \right]$

c Brad 20; Flynn 10; Lina 15

2 a $4a + 2b + c = 0, a + b + c = 1$

b $a = \frac{c - 2}{2}, b = \frac{4 - 3c}{2}$

c $a = \frac{1}{6}, b = -\frac{3}{2}, c = \frac{7}{3}$

3 a $a + b + c + d = 1, a - b + c - d = 4,$
 $4a + 3b + 2c + d = 0$

b $a = \frac{1}{4}(4d - 1), b = \frac{-2d - 3}{2},$

$c = \frac{1}{4}(11 - 4d)$

- c** $a = \frac{9}{40}$, $b = -\frac{3}{2}$, $c = \frac{9}{5}$, $d = \frac{38}{67}$
- 4 a** $x = -\lambda$, $y = \lambda + 1$, $z = \lambda$ for $\lambda \in \mathbb{R}$
- b i** $p = 2$ or $p = -2$ **ii** $p \in \mathbb{R} \setminus \{-2, 2\}$
- iii** No value of p
- 5 a** $r = \frac{1}{2}(3 + \lambda)i + \frac{1}{2}(1 - \lambda)j + \lambda k$
- b i** $p \in \mathbb{R} \setminus \{-1, 1\}$; $\left(\frac{2p+1}{p+1}, \frac{1}{p+1}, \frac{p-1}{p+1}\right)$
- ii** $p = 1$ **iii** $p = 0$
- c** $(0, 0, 0)$, $(2, 0, 0)$, $(0, 2, 0)$, $(0, 0, -2)$
- d** $\left(1 - \frac{\sqrt{2}}{2}, 1 + \frac{\sqrt{2}}{2}, -1 - \sqrt{2}\right)$,
 $\left(1 + \frac{\sqrt{2}}{2}, 1 - \frac{\sqrt{2}}{2}, -1 + \sqrt{2}\right)$

Chapter 8

Exercise 8A

- 1 a** 6 **b** -7 **c** 13
- 2 a** $5i$ **b** $3\sqrt{3}i$ **c** $-5i$
- d** $13i$ **e** $5\sqrt{2}i$ **f** $-2\sqrt{3}$
- g** $-1 + 2i$ **h** 4 **i** 0
- 3 a** $x = 5, y = 0$ **b** $x = 0, y = 2$
- c** $x = 0, y = 0$ **d** $x = 9, y = -4$
- e** $x = -2, y = -2$ **f** $x = 13, y = 6$
- 4 a** $5 + i$ **b** $4 + 4i$ **c** $5 - 5i$
- d** $4 - 3i$ **e** $-1 + i$ **f** 2
- g** 2 **h** 1 **i** $3 - 2i$

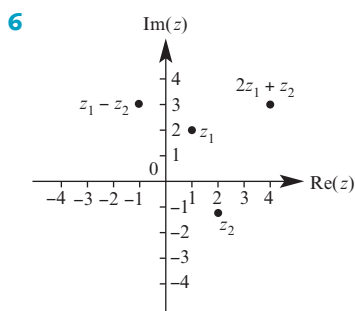
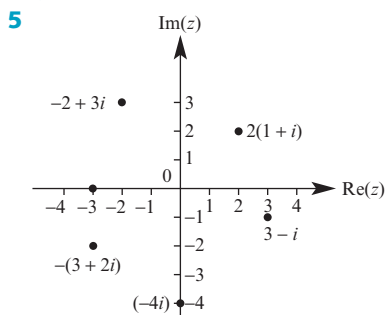

- 7 a** $11 + 3i$ **b** $-23 + 41i$ **c** 13
- d** $-8 + 6i$ **e** $3 - 4i$ **f** $-2 + 2i$
- g** 1 **h** $5 - 6i$ **i** -1

- 8 a** $x = 4, y = -3$ **b** $x = -2, y = 5$
- c** $x = -3$ **d** $x = 3, y = -3$ or $x = -3, y = 3$
- e** $x = 3, y = 2$

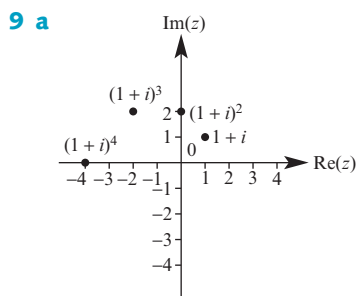

- b** Anticlockwise turn by $\frac{\pi}{4}$ about the origin;
 distance from origin increases by factor $\sqrt{2}$

- 10 a** $\vec{PQ} = \begin{bmatrix} -3 \\ -1 \end{bmatrix} = \vec{OR}$ **b** $|\vec{PQ}| = \sqrt{10}$

Exercise 8B

- 1 a** $\sqrt{3}$ **b** $-8i$ **c** $4 + 3i$
- d** $-1 + 2i$ **e** $4 - 2i$ **f** $-3 + 2i$
- 2 a** i **b** $\frac{3}{10} - \frac{1}{10}i$ **c** $-3 + 4i$
- d** $\frac{17}{5} + \frac{1}{5}i$ **e** $\frac{-1 - \sqrt{3}}{2} + \frac{\sqrt{3} - 1}{2}i$
- f** $4 + i$
- 4 a** $5 - 5i$ **b** $6 + i$ **c** $2 + 3i$
- d** $\frac{2 - i}{5}$ **e** $-8i$ **f** $8 + 6i$
- 5 a** $a^2 + b^2$ **b** $\frac{a}{a^2 + b^2} + \frac{b}{a^2 + b^2}i$
- c** $2a$ **d** $2bi$ **e** $\frac{a^2 - b^2}{a^2 + b^2} + \frac{2ab}{a^2 + b^2}i$
- f** $\frac{a^2 - b^2}{a^2 + b^2} - \frac{2ab}{a^2 + b^2}i$

Exercise 8C

- 1 a** $3; \pi$ **b** $5; \frac{\pi}{2}$ **c** $\sqrt{2}; \frac{3\pi}{4}$
- d** $2; \frac{\pi}{6}$ **e** $4; -\frac{\pi}{3}$ **f** $16; -\frac{2\pi}{3}$
- 2 a** 1.18 **b** 2.06 **c** -2.50
- d** -0.96 **e** 0.89 **f** -1.98
- 3 a** $\frac{5\pi}{3}$ **b** $\frac{3\pi}{2}$ **c** $\frac{5\pi}{6}$
- d** $\frac{\pi}{4}$ **e** $-\frac{11\pi}{6}$ **f** $-\frac{3\pi}{2}$
- 4 a** $-\frac{3\pi}{4}$ **b** $\frac{5\pi}{6}$ **c** $\frac{\pi}{8}$ **d** $-\frac{\pi}{2}$
- 5 a** $\sqrt{2} \operatorname{cis}\left(-\frac{3\pi}{4}\right)$ **b** $\operatorname{cis}\left(-\frac{\pi}{3}\right)$
- c** $\sqrt{6} \operatorname{cis}\left(-\frac{\pi}{4}\right)$ **d** $\frac{2}{3} \operatorname{cis}\left(\frac{\pi}{6}\right)$
- e** $2\sqrt{2} \operatorname{cis}\left(-\frac{\pi}{6}\right)$ **f** $4 \operatorname{cis}\left(\frac{5\pi}{6}\right)$

- 6 a $-\sqrt{2} + \sqrt{2}i$ b $\frac{5}{2} - \frac{5\sqrt{3}}{2}i$ c $2 + 2i$
 d $\frac{-3\sqrt{3}}{2} - \frac{3}{2}i$ e $6i$ f -4
 8 a $2 \operatorname{cis}\left(-\frac{3\pi}{4}\right)$ b $7 \operatorname{cis}\left(\frac{2\pi}{3}\right)$
 c $3 \operatorname{cis}\left(\frac{\pi}{3}\right)$ d $5 \operatorname{cis}\left(\frac{\pi}{4}\right)$

Exercise 8D

- 1 $(2\sqrt{3} - 3) + (3\sqrt{3} + 2)i$
 2 a $12 \operatorname{cis}\left(-\frac{7\pi}{12}\right)$ b $\frac{1}{2} \operatorname{cis}\left(-\frac{\pi}{3}\right)$
 c $\frac{7}{6} \operatorname{cis}\left(-\frac{\pi}{15}\right)$ d $8 \operatorname{cis}\left(-\frac{19\pi}{20}\right)$ e $-\frac{1}{8}$
 3 a $8 \operatorname{cis}\left(\frac{\pi}{3}\right)$ b $\frac{8}{27} \operatorname{cis}\left(\frac{\pi}{8}\right)$
 c $27 \operatorname{cis}\left(\frac{5\pi}{6}\right)$ d $-32i$ e -216
 f $1024 \operatorname{cis}\left(-\frac{\pi}{12}\right)$ g $\frac{27}{4} \operatorname{cis}\left(-\frac{\pi}{20}\right)$
 4 a $\operatorname{Arg}(z_1 z_2) = \frac{7\pi}{12}; \operatorname{Arg}(z_1) + \operatorname{Arg}(z_2) = \frac{7\pi}{12};$
 $\operatorname{Arg}(z_1 z_2) = \operatorname{Arg}(z_1) + \operatorname{Arg}(z_2)$
 b $\operatorname{Arg}(z_1 z_2) = \frac{7\pi}{12}; \operatorname{Arg}(z_1) + \operatorname{Arg}(z_2) = \frac{-17\pi}{12};$
 $\operatorname{Arg}(z_1 z_2) = \operatorname{Arg}(z_1) + \operatorname{Arg}(z_2) + 2\pi$
 c $\operatorname{Arg}(z_1 z_2) = \frac{-5\pi}{6}; \operatorname{Arg}(z_1) + \operatorname{Arg}(z_2) = \frac{7\pi}{6};$
 $\operatorname{Arg}(z_1 z_2) = \operatorname{Arg}(z_1) + \operatorname{Arg}(z_2) - 2\pi$
 6 a $\frac{\pi}{4}$ b $\frac{-3\pi}{4}$ c $\frac{-\pi}{4}$
 7 b i $\operatorname{cis}\left(\frac{3\pi}{2} - 7\theta\right)$ ii i
 iii $\operatorname{cis}(4\theta)$ iv $\operatorname{cis}(\pi - \theta - \varphi)$
 8 b i $\operatorname{cis}(-5\theta)$ ii $\operatorname{cis}(3\theta)$ iii 1
 iv $\operatorname{cis}\left(\frac{\pi}{2} - 2\theta\right)$
 9 b i $\operatorname{cis}(6\theta - 3\pi)$ ii $\operatorname{cis}(\pi - 2\theta)$
 iii $\operatorname{cis}(\theta - \pi)$ iv $-i$
 10 a i $\sec \theta \csc \theta$
 ii $\operatorname{cosec} \theta \operatorname{cis}\left(\frac{\pi}{2} - \theta\right)$
 iii $\frac{1}{\sin \theta \cos \theta} \operatorname{cis} \theta = \operatorname{cosec} \theta \sec \theta \operatorname{cis} \theta$
 b i $\sec^2 \theta \operatorname{cis}(2\theta)$
 ii $\sin^3 \theta \operatorname{cis}\left(3\theta - \frac{3\pi}{2}\right)$
 iii $\operatorname{cosec} \theta \sec \theta \operatorname{cis}(-\theta)$
 11 a $64 \operatorname{cis} 0 = 64$ b $\frac{\sqrt{2}}{8} \operatorname{cis}\left(\frac{-3\pi}{4}\right)$
 c $128 \operatorname{cis}\left(\frac{-2\pi}{3}\right)$ d $\frac{\sqrt{3}}{72} \operatorname{cis}\left(\frac{-\pi}{2}\right) = -\frac{\sqrt{3}}{72}i$
 e $\sqrt{2} \operatorname{cis}\left(\frac{-\pi}{4}\right)$ f $\frac{64\sqrt{3}}{3} \operatorname{cis}\left(\frac{3\pi}{4}\right)$

- g $\frac{\sqrt{2}}{2} \operatorname{cis}\left(\frac{\pi}{2}\right) = \frac{\sqrt{2}}{2}i$ h $\frac{1}{4} \operatorname{cis}\left(-\frac{2\pi}{15}\right)$
 i $8\sqrt{2} \operatorname{cis}\left(\frac{11\pi}{12}\right)$

Exercise 8E

- 1 a $(z + 4i)(z - 4i)$
 b $(z + \sqrt{5}i)(z - \sqrt{5}i)$
 c $(z + 1 + 2i)(z + 1 - 2i)$
 d $\left(z - \frac{3}{2} + \frac{\sqrt{7}}{2}i\right)\left(z - \frac{3}{2} - \frac{\sqrt{7}}{2}i\right)$
 e $2\left(z - 2 + \frac{\sqrt{2}}{2}i\right)\left(z - 2 - \frac{\sqrt{2}}{2}i\right)$
 f $3\left(z + 1 + \frac{\sqrt{3}}{3}i\right)\left(z + 1 - \frac{\sqrt{3}}{3}i\right)$
 g $3\left(z + \frac{1}{3} + \frac{\sqrt{5}}{3}i\right)\left(z + \frac{1}{3} - \frac{\sqrt{5}}{3}i\right)$
 h $2\left(z - \frac{1}{4} + \frac{\sqrt{23}}{4}i\right)\left(z - \frac{1}{4} - \frac{\sqrt{23}}{4}i\right)$
 2 a $5i, -5i$ b $2\sqrt{2}i, -2\sqrt{2}i$
 c $2 + i, 2 - i$
 d $-\frac{7}{6} + \frac{\sqrt{11}}{6}i, -\frac{7}{6} - \frac{\sqrt{11}}{6}i$
 e $1 - \sqrt{2}i, 1 + \sqrt{2}i$
 f $\frac{3}{10} + \frac{\sqrt{11}}{10}i, \frac{3}{10} - \frac{\sqrt{11}}{10}i$
 g $-i, -1 - i$ h $i, -1 - i$

Exercise 8F

- 1 a $(z - 5)\left(z + \frac{1}{2} + \frac{\sqrt{3}}{2}i\right)\left(z + \frac{1}{2} - \frac{\sqrt{3}}{2}i\right)$
 b $(z + 2)\left(z - \frac{3}{2} + \frac{\sqrt{11}}{2}i\right)\left(z - \frac{3}{2} - \frac{\sqrt{11}}{2}i\right)$
 c $3(z - 4)\left(z - \frac{1}{6} + \frac{\sqrt{11}}{6}i\right)\left(z - \frac{1}{6} - \frac{\sqrt{11}}{6}i\right)$
 d $2(z + 3)\left(z - \frac{3}{4} + \frac{\sqrt{31}}{4}i\right)\left(z - \frac{3}{4} - \frac{\sqrt{31}}{4}i\right)$
 e $(z + i)(z - i)(z - 2 + i)$
 2 b $z - 1 + i$
 c $(z + 6)(z - 1 + i)(z - 1 - i)$
 3 b $z + 2 + i$
 c $(2z + 1)(z + 2 + i)(z + 2 - i)$
 4 b $z - 1 - 3i$
 c $(z - 1 + 3i)(z - 1 - 3i)(z + 1 + i)(z + 1 - i)$
 5 a $(z + 3)(z - 3)(z + 3i)(z - 3i)$
 b $(z + 2)(z - 2)(z - 1 + \sqrt{3}i)(z - 1 - \sqrt{3}i)$
 $(z + 1 + \sqrt{3}i)(z + 1 - \sqrt{3}i)$
 6 a $(z - i)\left(z + \frac{1}{2} + \frac{\sqrt{3}}{2}i\right)\left(z + \frac{1}{2} - \frac{\sqrt{3}}{2}i\right)$
 b $(z + i)(z - 1 + \sqrt{2})(z - 1 - \sqrt{2})$
 c $(z - 2i)(z - 3)(z + 1)$
 d $2(z - i)\left(z + \frac{1}{4} + \frac{\sqrt{41}}{4}i\right)\left(z + \frac{1}{4} - \frac{\sqrt{41}}{4}i\right)$

- 7 a** 8 **b** -4 **c** -6
8 a 3, $-2 \pm \sqrt{2}i$ **b** 5, $\frac{1 \pm \sqrt{23}i}{2}$
c -1, $\frac{5 \pm \sqrt{7}i}{2}$ **d** -2, 3, $\frac{1 \pm \sqrt{23}i}{2}$
9 a $a = 0, b = 4$ **b** $a = -6, b = 13$
c $a = 2, b = 10$
10 a $1 - 3i, \frac{1}{3}$ **b** $-2 + i, 2 \pm \sqrt{2}i$
11 $P(x) = -2x^3 + 10x^2 - 18x + 10;$
 $x = 1$ or $x = 2 \pm i$
12 $a = 6, b = -8$
13 a $z^2 - 4z + 5, a = -7, b = 6$
b $z = 2 \pm i$ or $z = -\frac{1}{2}$
14 a $P(1 + i) = (-4a + d - 2) + 2(a - 1)i$
b $a = 1, d = 6$
c $z = 1 \pm i$ or $z = -1 \pm \sqrt{2}i$
15 $p = -(5 + 4i), q = 1 + 7i$
16 $z = 1 + i$ or $z = 2$
17 a $3 + i$ **b** $2i, \pm\sqrt{6}$
c $1, \pm\sqrt{6}i$ **d** $2, -\frac{1}{2} \pm \frac{\sqrt{15}}{2}i$
e $\frac{\sqrt{2}}{4} \pm \frac{\sqrt{14}}{4}i$ **f** $0, -1 \pm 2\sqrt{2}i$

Exercise 8G

- 1 a** $z = i$ or $z = -i$

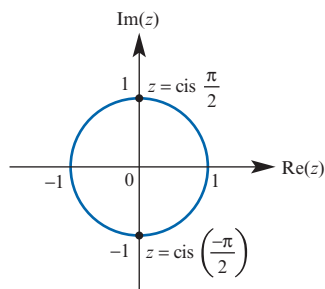

- b** $z = 3\left(\frac{\sqrt{3}}{2} + \frac{1}{2}i\right), z = 3\left(\frac{-\sqrt{3}}{2} + \frac{1}{2}i\right)$ or $z = -3i$

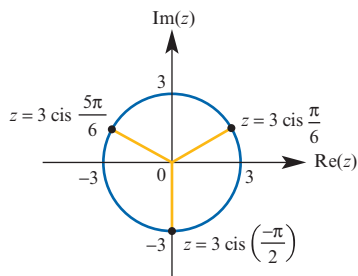

- c** $z = \sqrt{2}\left(\frac{\sqrt{3}}{2} + \frac{1}{2}i\right)$ or $z = \sqrt{2}\left(-\frac{\sqrt{3}}{2} - \frac{1}{2}i\right)$

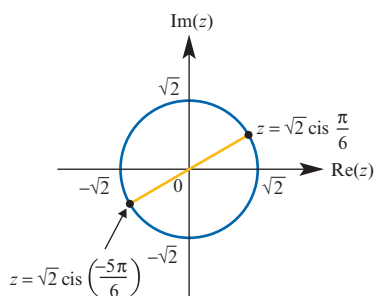

- d** $z = \sqrt{2}\left(\frac{\sqrt{3}}{2} - \frac{1}{2}i\right)$ or $z = \sqrt{2}\left(-\frac{\sqrt{3}}{2} + \frac{1}{2}i\right)$

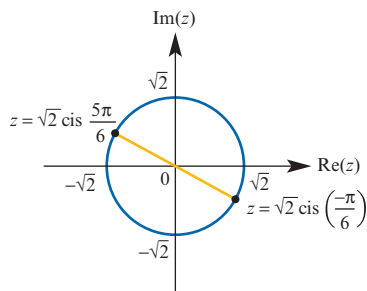

- e** $z = \frac{\sqrt{3}}{2} + \frac{1}{2}i, z = -\frac{\sqrt{3}}{2} + \frac{1}{2}i$ or $z = -i$

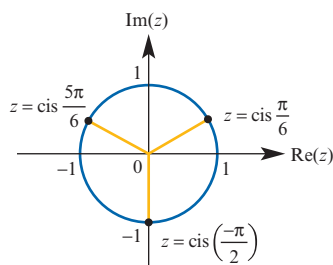

- f** $z = \frac{\sqrt{3}}{2} - \frac{1}{2}i, z = i$ or $z = -\frac{\sqrt{3}}{2} - \frac{1}{2}i$

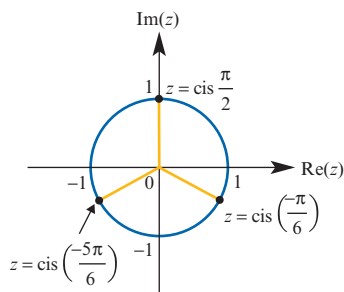

- 2 a** $2 \operatorname{cis}\left(\frac{-\pi}{12}\right), 2 \operatorname{cis}\left(\frac{7\pi}{12}\right), 2 \operatorname{cis}\left(\frac{-3\pi}{4}\right)$

- b** $2 \operatorname{cis}\left(\frac{\pi}{4}\right), 2 \operatorname{cis}\left(\frac{11\pi}{12}\right), 2 \operatorname{cis}\left(\frac{-5\pi}{12}\right)$

- c** $2 \operatorname{cis}\left(\frac{-5\pi}{18}\right), 2 \operatorname{cis}\left(\frac{7\pi}{18}\right), 2 \operatorname{cis}\left(\frac{-17\pi}{18}\right)$

- d** $2 \operatorname{cis}\left(\frac{-\pi}{18}\right), 2 \operatorname{cis}\left(\frac{11\pi}{18}\right), 2 \operatorname{cis}\left(\frac{-13\pi}{18}\right)$

e $5 \operatorname{cis}\left(\frac{-\pi}{6}\right), 5 \operatorname{cis}\left(\frac{\pi}{2}\right), 5 \operatorname{cis}\left(\frac{-5\pi}{6}\right)$

f $2^{\frac{1}{6}} \operatorname{cis}\left(\frac{\pi}{4}\right), 2^{\frac{1}{6}} \operatorname{cis}\left(\frac{11\pi}{12}\right), 2^{\frac{1}{6}} \operatorname{cis}\left(\frac{-5\pi}{12}\right)$

3 a $a^2 - b^2 = 3, 2ab = 4$

b $a = \pm 2, b = \pm 1$;
square roots of $3 + 4i$ are $\pm(2 + i)$

4 a $\pm(1 - 4i)$ b $\pm \frac{\sqrt{2}}{2}(7 + i)$

c $\pm(1 + 2i)$ d $\pm(3 + 4i)$

5 $\sqrt{2} \operatorname{cis}\left(\frac{\pi}{6}\right), \sqrt{2} \operatorname{cis}\left(\frac{-5\pi}{6}\right), \sqrt{2} \operatorname{cis}\left(\frac{-\pi}{6}\right),$
 $\sqrt{2} \operatorname{cis}\left(\frac{5\pi}{6}\right)$

6 $z = \frac{\sqrt{2}}{2} + \frac{\sqrt{2}}{2}i$ or $z = \frac{-\sqrt{2}}{2} - \frac{\sqrt{2}}{2}i$;
 $z^2 - i = \left(z - \frac{\sqrt{2}}{2} - \frac{\sqrt{2}}{2}i\right)\left(z + \frac{\sqrt{2}}{2} + \frac{\sqrt{2}}{2}i\right)$

7 $z = \operatorname{cis} \frac{\pi}{8}, \operatorname{cis} \frac{3\pi}{8}, \operatorname{cis} \frac{5\pi}{8}, \operatorname{cis} \frac{7\pi}{8}, \operatorname{cis} \frac{9\pi}{8},$
 $\operatorname{cis} \frac{11\pi}{8}, \operatorname{cis} \frac{13\pi}{8}$ or $\operatorname{cis} \frac{15\pi}{8}$;

$$z^8 + 1 = \left(z - \operatorname{cis} \frac{\pi}{8}\right)\left(z - \operatorname{cis} \frac{3\pi}{8}\right)\left(z - \operatorname{cis} \frac{5\pi}{8}\right)$$

$$\left(z - \operatorname{cis} \frac{7\pi}{8}\right)\left(z - \operatorname{cis} \frac{9\pi}{8}\right)\left(z - \operatorname{cis} \frac{11\pi}{8}\right)$$

$$\left(z - \operatorname{cis} \frac{13\pi}{8}\right)\left(z - \operatorname{cis} \frac{15\pi}{8}\right)$$

8 a i $\pm\left(\sqrt{\frac{1 + \sqrt{2}}{2}} + \sqrt{\frac{\sqrt{2} - 1}{2}}i\right)$

ii $2^{\frac{1}{4}} \operatorname{cis}\left(\frac{\pi}{8}\right), 2^{\frac{1}{4}} \operatorname{cis}\left(\frac{-7\pi}{8}\right)$

b $\cos\left(\frac{\pi}{8}\right) = \frac{(2 + \sqrt{2})^{\frac{1}{2}}}{2}, \sin\left(\frac{\pi}{8}\right) = \frac{(2 - \sqrt{2})^{\frac{1}{2}}}{2}$

Exercise 8H

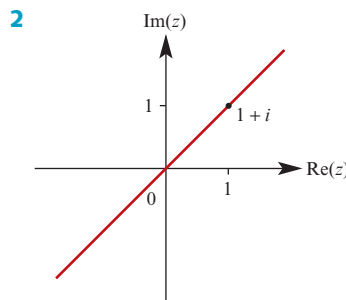
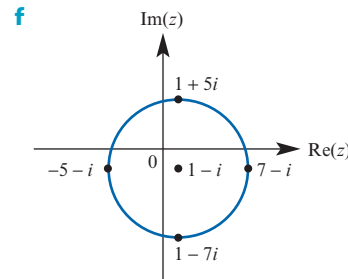
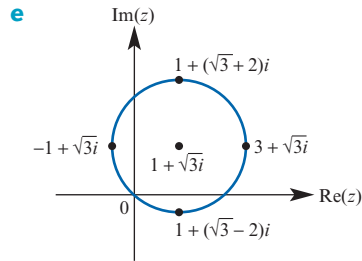
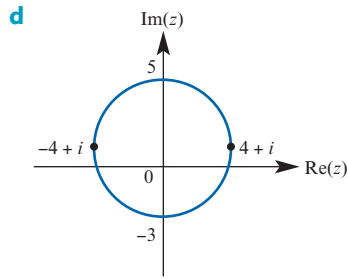
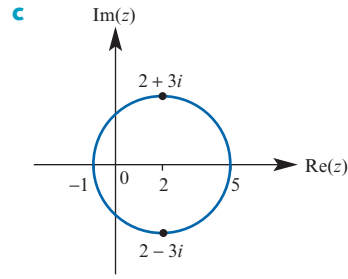
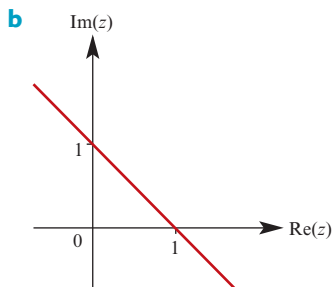
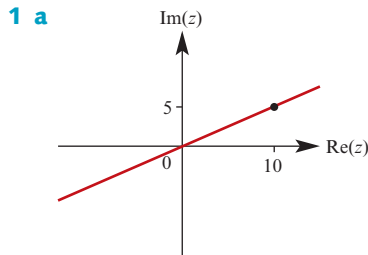

3 The imaginary axis, i.e. $\{z : \operatorname{Re}(z) = 0\}$

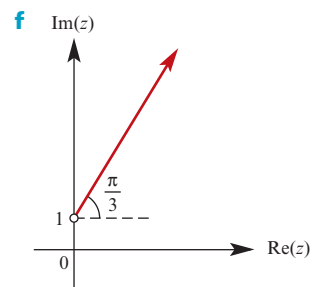
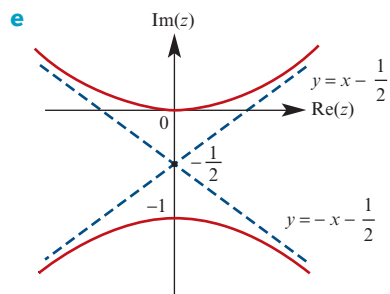
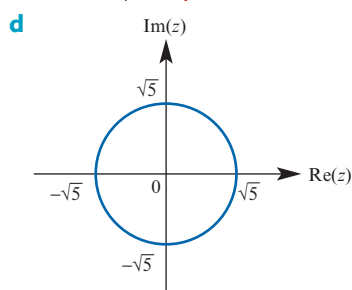
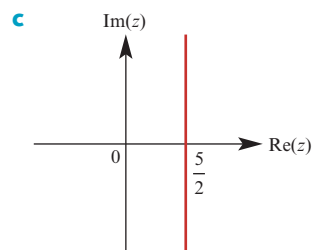
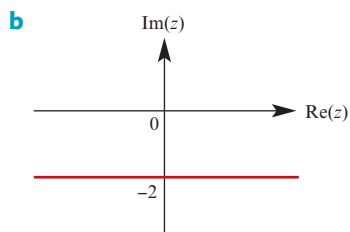
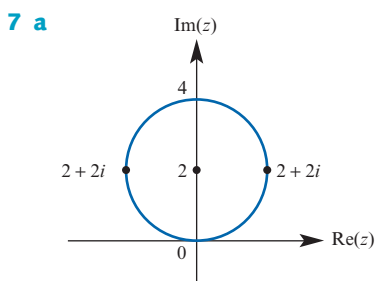
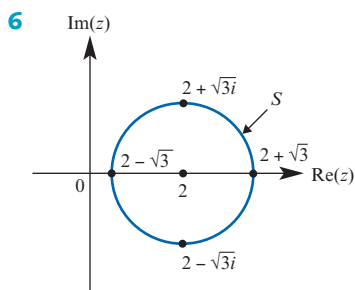
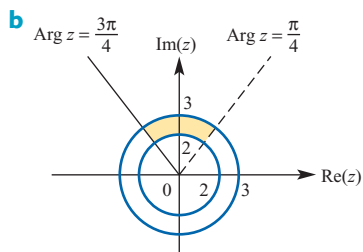
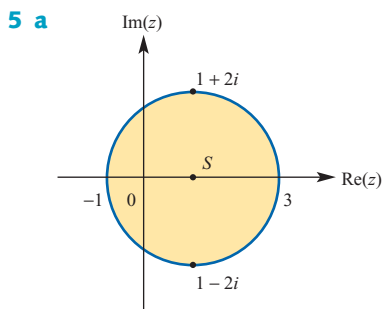
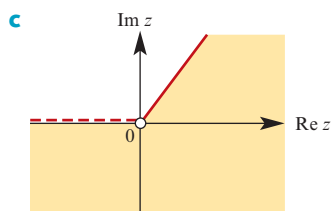
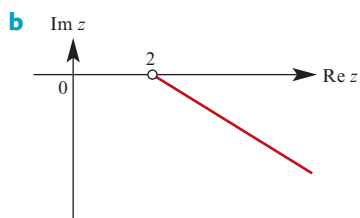
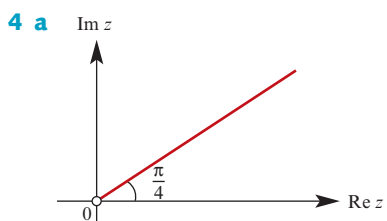

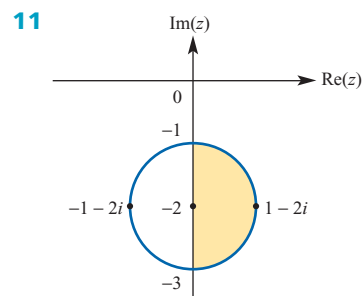
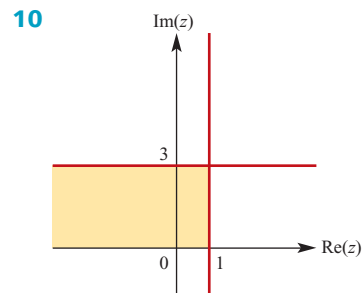
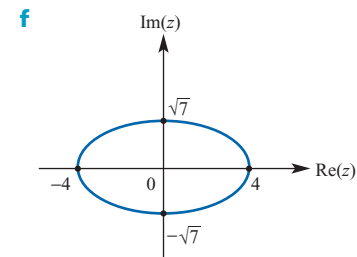
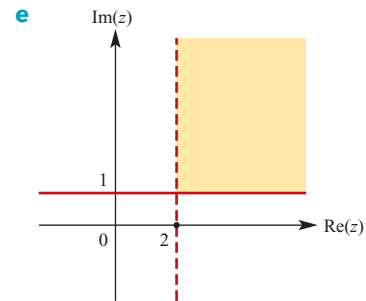
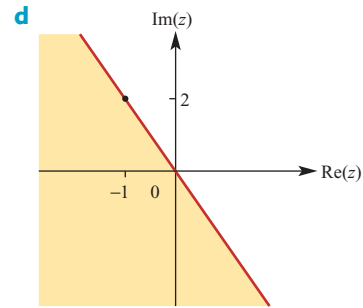
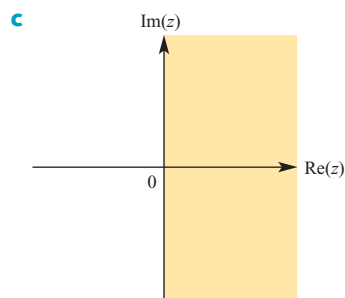
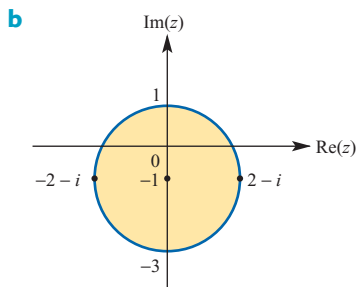
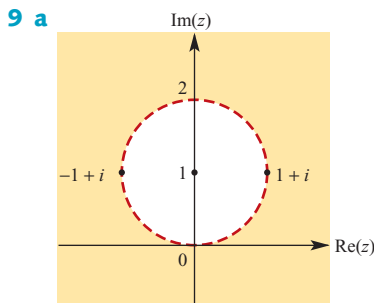
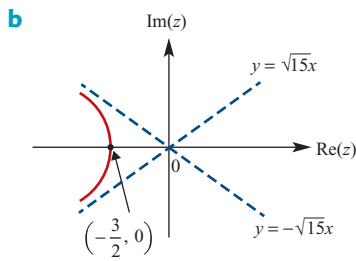
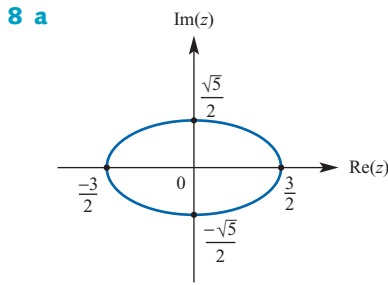

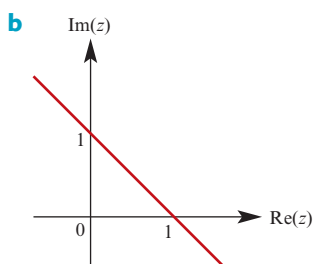
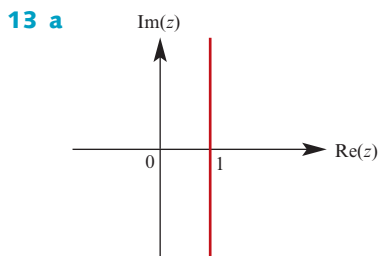
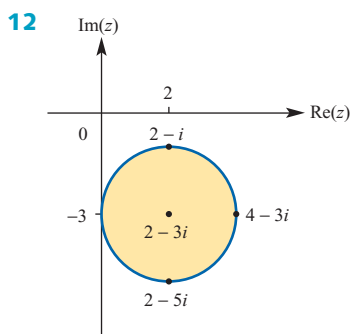

14 $x^2 + y^2 = 1$

15 Centre $\left(\frac{8}{3}, -2\right)$; radius $\frac{4\sqrt{10}}{3}$

16 $|z|^2 = 1$

17 a Circle with centre (1, 1) and radius 1

b $y = -x$

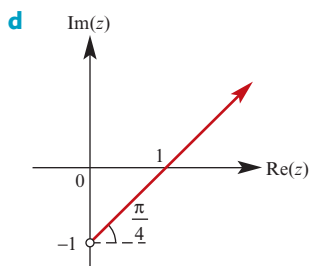
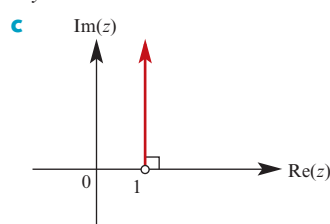

18 Circle with centre $2 + 4i$ and radius 6

19 a $z = -1 \pm \sqrt{3}i$

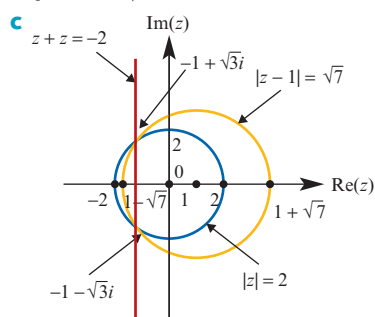

Chapter 8 review

Short-answer questions

1 a $8 - 5i$ **b** $-i$ **c** $29 + 11i$

d 13 **e** $\frac{6}{13} + \frac{4}{13}i$ **f** $\frac{9}{5} - \frac{7}{5}i$

g $\frac{3}{5} + \frac{6}{5}i$ **h** $-8 - 6i$ **i** $\frac{43}{10} + \frac{81}{10}i$

2 a $2 + 3i$ **b** $-6 + 2i$ **c** $-3 \pm \sqrt{3}i$

d $\frac{3}{\sqrt{2}}(1 + i), \frac{3}{\sqrt{2}}(-1 + i)$

e $3, \frac{3}{2}(-1 \pm \sqrt{3}i)$ or $3 \operatorname{cis}\left(\pm \frac{2\pi}{3}\right)$

f $-\frac{3}{2}, \frac{3}{4}(1 \pm \sqrt{3}i)$ or $\frac{3}{2} \operatorname{cis}\left(\pm \frac{\pi}{3}\right)$

3 a $2 - i, 2 + i, -2$ **b** $3 - 2i, 3 + 2i, -1$

c $1 + i, 1 - i, 2$

4 a $2\left(x + \frac{3}{4} + \frac{\sqrt{7}}{4}i\right)\left(x + \frac{3}{4} - \frac{\sqrt{7}}{4}i\right)$

b $(x-1)(x+i)(x-i)$

c $(x+2)^2(x-2)$

5 2 and -1 ; -2 and 1

6 a iv **b** ii **c** i **d** iii

7 -1 and 5; 1 and -5

8 $a = 2, b = 5$

9 $\frac{1}{2} \operatorname{cis}\left(-\frac{\pi}{3}\right)$

10 $a = \frac{3}{2} - \frac{\sqrt{3}}{2}, b = \frac{1}{2} + \frac{3\sqrt{3}}{2}$

11 a $2 + 2i$ **b** $\frac{1}{2}(1 + i)$ **c** $8\sqrt{2}$ **d** $\frac{\pi}{4}$

12 a i $\sqrt{2}$ **ii** 2 **iii** $\frac{\pi}{4}$ **iv** $-\frac{\pi}{3}$

b $\frac{\sqrt{2}}{2}, -\frac{\pi}{12}$

13 $2 \operatorname{cis}\left(\frac{\pi}{6}\right), -64\sqrt{3} - 64i$

14 $\pm 3, \pm 3i, 1 \pm i$

15 $16 - 16i$

16 $-2i, i, -2, k = -2$ or 1

17 a $(z+2)(z-1+i)(z-1-i)$ **b** 25

18 $-1 + 2i, -1 - \frac{1}{2}i$

19 a $(x - 1)^2 + (y - 1)^2 \leq 1$

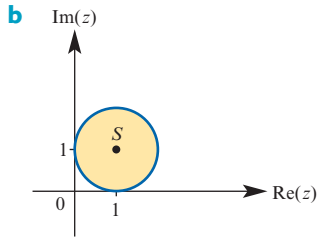

20 The real axis, i.e. $\{z : \text{Im}(z) = 0\}$

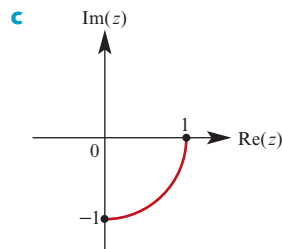
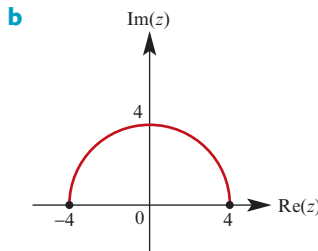
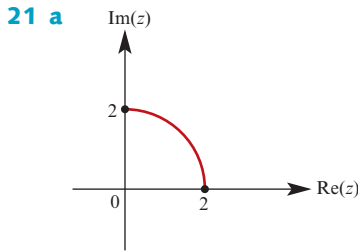

22 $(\frac{5}{6}, \frac{-7}{6})$

23 a $4 - 3i$

b $c = 12 + 3i, d = 9 - i$ or
 $c = 4 + 9i, d = 1 + 5i$

24 a $2 \text{cis}(\frac{\pi}{3}), 2 \text{cis} \pi, 2 \text{cis}(-\frac{\pi}{3})$

b $2 \text{cis}(\frac{\pi}{6}), 2 \text{cis}(-\frac{5\pi}{6})$

25 a $x^6 - 1 = (x + 1)(x - 1)(x^2 - x + 1)(x^2 + x + 1)$

b $x^6 - 1 = (x + 1)(x - 1)$
 $(x - \frac{1}{2} + \frac{\sqrt{3}}{2}i)(x - \frac{1}{2} - \frac{\sqrt{3}}{2}i)$
 $(x + \frac{1}{2} + \frac{\sqrt{3}}{2}i)(x + \frac{1}{2} - \frac{\sqrt{3}}{2}i)$

c $-1, 1, \frac{1}{2} \pm \frac{\sqrt{3}}{2}i, -\frac{1}{2} \pm \frac{\sqrt{3}}{2}i$

26 a 1 b 1 c 0

27 $\frac{-\pi}{4}$

28 a $-2 + 2\sqrt{3}i$

b $-3 - 6i$

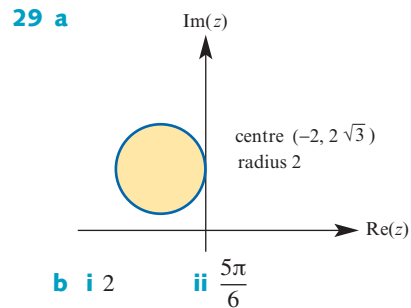

Multiple-choice questions

- 1 E 2 C 3 D 4 E 5 D
6 B 7 B 8 C 9 B 10 A

Extended-response questions

1 a $|z^7| = 16\ 384; \text{Arg}(z^7) = \frac{-\pi}{6}$

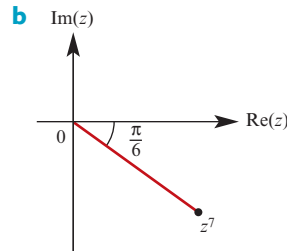

c $2\sqrt{2} \text{cis}(\frac{7\pi}{12})$

d $z = -2\sqrt{3} + 2i, w = 1 + i,$

$\frac{z}{w} = (1 - \sqrt{3}) + (1 + \sqrt{3})i$

e $-2 - \sqrt{3}$

f $\frac{1}{\sqrt{3}}$

2 b 3, $2 - i$

d $z^5 - 9z^4 + 36z^3 - 84z^2 + 115z - 75$

3 a $z = \sqrt{3} \pm i$

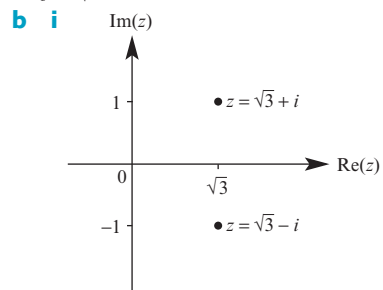

ii $x^2 + y^2 = 4$

iii $a = 2$

iv $P(z) = z^2 + 2\sqrt{3}z + 4$

The solutions to the equation $z^6 + 64 = 0$ are equally spaced around the circle $x^2 + y^2 = 4$, and represent the sixth roots of -64 . Three of the solutions are the conjugates of the other three solutions.

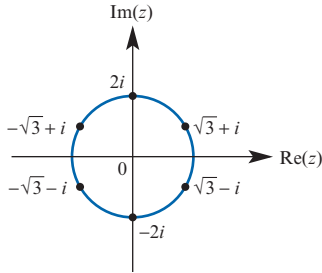

4 a $8 \operatorname{cis}\left(\frac{-5\pi}{6}\right)$

b $2 \operatorname{cis}\left(\frac{-5\pi}{18}\right), 2 \operatorname{cis}\left(\frac{7\pi}{18}\right), 2 \operatorname{cis}\left(\frac{-17\pi}{18}\right)$

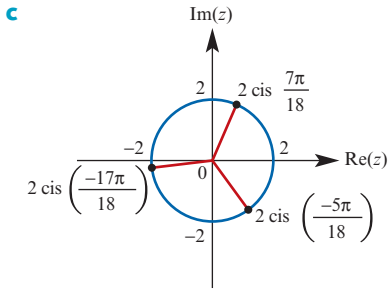

d i $(z - \sqrt{3}i)^3 = -4\sqrt{3} - 4i$
ii $2 \cos\left(\frac{-5\pi}{18}\right) + \left(2 \sin\left(\frac{-5\pi}{18}\right) + \sqrt{3}\right)i,$
 $2 \cos\left(\frac{7\pi}{18}\right) + \left(2 \sin\left(\frac{7\pi}{18}\right) + \sqrt{3}\right)i,$
 $2 \cos\left(\frac{-17\pi}{18}\right) + \left(2 \sin\left(\frac{-17\pi}{18}\right) + \sqrt{3}\right)i$

5 a $\vec{XY} = \sqrt{3}i - j, \vec{XZ} = 2\sqrt{3}i + 2j$

b $z_3 = 1 + \sqrt{3}i$

c $z_3 = 2 \operatorname{cis}\left(\frac{\pi}{3}\right); W$ corresponds to $6\sqrt{3}$

d $(4\sqrt{3}, 0)$

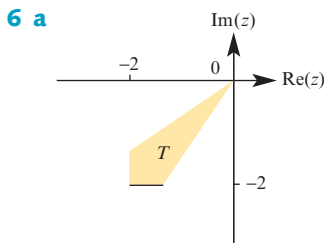

b $T = \{z : \operatorname{Re}(z) > -2\} \cap \{z : \operatorname{Im}(z) \geq -2\}$

$\cap \left\{z : \frac{-5\pi}{6} < \operatorname{Arg}(z) < \frac{-2\pi}{3}\right\}$

7 a $k > -\frac{5}{4}$ **b** $k = -\frac{5}{4}$ **c** $-2 < k < -\frac{5}{4}$

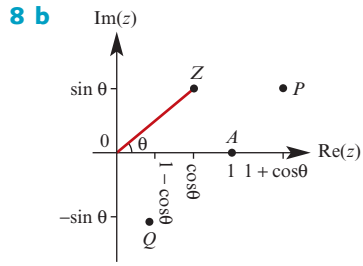

c $\operatorname{cosec} \theta + \cot \theta = \cot\left(\frac{\theta}{2}\right)$

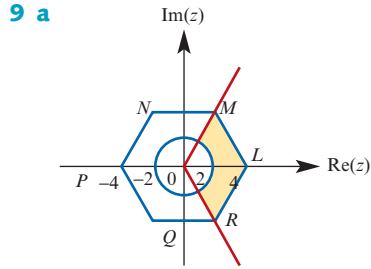

b $|z - 4| = 4$

c N is $4 \operatorname{cis}\left(\frac{2\pi}{3}\right); Q$ is $4 \operatorname{cis}\left(\frac{-2\pi}{3}\right)$

d New position of N is $4 \operatorname{cis}\left(\frac{5\pi}{12}\right);$
 new position of Q is $4 \operatorname{cis}\left(\frac{-11\pi}{12}\right)$

10 b $z_3 = \sqrt{2} \operatorname{cis}(\tan^{-1}(2 - \sqrt{3})) = \sqrt{2} \operatorname{cis}\left(\frac{\pi}{12}\right)$

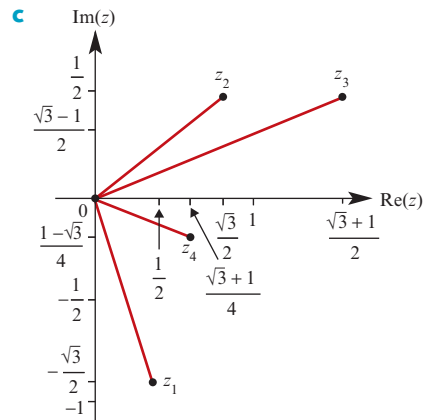

11 a ii $q = 2k^3$

b $b = -1 - i, c = 2 + 2i$

12 a i $6\sqrt{2}$ **ii** 6

b ii Isosceles

13 a i 13 **ii** $157.38^\circ = 2.75^c$

b i $\cos \alpha = \frac{-12}{13}, \sin \alpha = \frac{5}{13}$

ii $r = \sqrt{13}, \cos(2\theta) = \frac{-12}{13}, \sin(2\theta) = \frac{5}{13}$

iii $\sin \theta = \pm \frac{5\sqrt{26}}{26}, \cos \theta = \pm \frac{\sqrt{26}}{26}$

iv $w = \pm \frac{\sqrt{2}}{2}(1 + 5i)$

- d** $\pm \frac{\sqrt{2}}{2}(5+i)$; a reflection of the square roots of $-12+5i$ in the line $\text{Re}(z) = \text{Im}(z)$
- 14 a** $(x + \frac{3}{2})^2 + y^2 = \frac{29}{4}$
b $(x + \frac{3}{2})^2 + (y - \frac{1}{2})^2 = \frac{15}{2}$
c $(x + \frac{\beta}{\alpha})^2 + y^2 = \frac{\beta^2 - \alpha\gamma}{\alpha^2}$
d $(x + \frac{a}{\alpha})^2 + (y - \frac{b}{\alpha})^2 = \frac{a^2 + b^2 - \alpha\gamma}{\alpha^2}$, where $\beta = a + bi$
- 15 a** $(\cos^5 \theta - 10 \cos^3 \theta \sin^2 \theta + 5 \cos \theta \sin^4 \theta) + (5 \cos^4 \theta \sin \theta - 10 \cos^2 \theta \sin^3 \theta + \sin^5 \theta)i$
- 16 a**

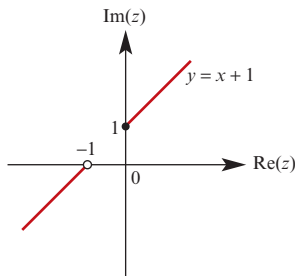

- b i**
-
- ii** max = 6; min = 2
iii max = $75^\circ = \frac{5\pi}{12}$; min = $15^\circ = \frac{\pi}{12}$

- 17 a** $2 \text{cis}(\pm \frac{2\pi}{3})$
c $z^2 + (2 - 2\sqrt{3}i)z - 4\sqrt{3}i$
 or $z^2 + (2 + 2\sqrt{3}i)z + 4\sqrt{3}i$
d -4
- 18 a i** $z = 2 \text{cis} \theta + \frac{1}{2} \text{cis}(-\theta)$
b i $z = 2i \text{cis} \theta - \frac{1}{2}i \text{cis}(-\theta)$

Chapter 9

Short-answer questions

- 1** -1
2 a $-i + 6j + k$ **b** (3, 3, 0) **c** $-\frac{3\sqrt{35}}{35}$
3 $x = -\frac{1}{4}, y = 0, z = \frac{1}{2}$
4 $z = \pm 2, z = \pm \sqrt{3}i$
5 $\frac{2}{3}(2i + j + 2k), \frac{1}{3}(5i + 4j - 7k)$

- 6** $\frac{\pi}{12}$
7 $z = 1, 2, -2 + i, -2 - i$
8 a $-i$ **b** $\frac{7\sqrt{6}}{18}$ **c** $\frac{\sqrt{5}}{2}$
9 a $m = \pm 5$ **b** $m = -\frac{5}{4}$
c $4i + 6j - 7k$ **d** $m = \frac{7}{2}$

- 10 a** $z = 1, \frac{1}{2} \pm \frac{\sqrt{3}}{2}i$
b $\text{cis}(0), \text{cis}(\frac{\pi}{3}), \text{cis}(-\frac{\pi}{3})$
c

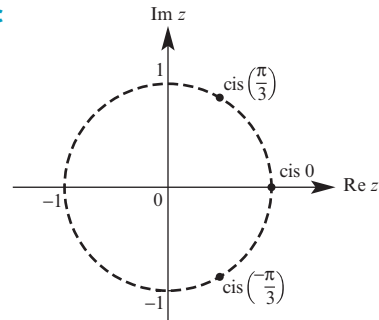

- 11** $z = 2 \text{cis}(\frac{\pi}{6}), z^2 = 4 \text{cis}(\frac{\pi}{3}), z^3 = 8 \text{cis}(\frac{\pi}{2}) = 8i$

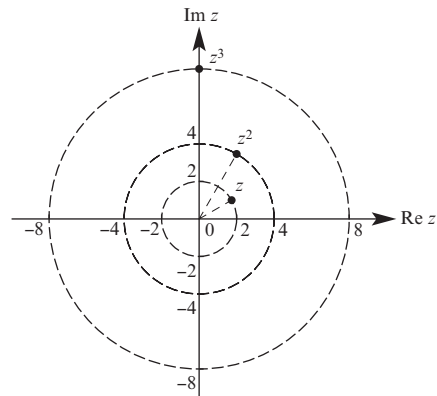

- 12 b** $(z - 1 - i)(z - 2 + 3i)(z - 2 - 3i)$
13 b $\lambda = \frac{2}{7}$
14 b i $(-1 \pm \sqrt{2})i$ **ii** i **iii** $\pm 1 - i$
15 a $a = 3, b = 4, c = 2$ **b** $-\sqrt{3} + i$
16 a $\frac{\sqrt{13}}{13}(3i + 2j)$
b i $-\frac{10}{13}(3i + 2j)$ **ii** $\frac{10\sqrt{13}}{13}$
17 a $r = \lambda(3i + 4k), \lambda \in \mathbb{R}$
b $r = 2j + k + \lambda(-i + j + 3k), \lambda \in \mathbb{R}$
c $r = 3i + 2j + 4k + \lambda(-3i + 2j - 6k), \lambda \in \mathbb{R}$
18 a $r \cdot (i - 2j + k) = 0$ **b** $r \cdot (-2i + 2k) = 6$
c $r \cdot (4i - 3j - 3k) = -6$
19 a $\frac{4}{3}$ **b** 3
20 (3, -1, -3)

21 a $x = \frac{ak - 2a - k - 2}{a - 5}, y = \frac{-2(k - 3)}{a - 5},$
 $z = \frac{-(ak - 4a + k + 6)}{a - 5}$

b $k \neq 3$ **c** $k = 3$

22 $(0, 1, 0)$

23 a 90° **b** 86.05°

24 3

25 a $a = -3$

b $r = \frac{1}{11}(25 - 14\lambda)i + \frac{27}{11}(\lambda - 1)j + \lambda k$

26 a $m = -3, n = -2$ **b** $\lambda = -\frac{1}{5}$

27 $a = -2$

28 a $\frac{2}{5}, b = -18;$

$x = \frac{5(\lambda - 7)}{6}, y = \frac{19 - 7\lambda}{3}, z = \lambda$

29 $a = \pm b$

Multiple-choice questions

- 1** C **2** D **3** B **4** A **5** E **6** D
7 C **8** E **9** A **10** C **11** C **12** B
13 C **14** C **15** C **16** C **17** C **18** B
19 E **20** B **21** D **22** B **23** B **24** D
25 E **26** D **27** C **28** B **29** A **30** C
31 B **32** A **33** D **34** A **35** B **36** E
37 E **38** C **39** C **40** D **41** B **42** C
43 D **44** B **45** C **46** B **47** D **48** C
49 E **50** D **51** C **52** D **53** B **54** E
55 C **56** E

Extended-response questions

1 a i $\frac{3}{2}(b - a)$ **ii** $\frac{1}{2}(3b - a)$

b i $\vec{AB} = i + 2j, \vec{BC} = 2i - j$ **iv** $3i - j$

c $x = 4, y = 5, z = 2$

2 a i **ii** $2\sqrt{2} - 2$

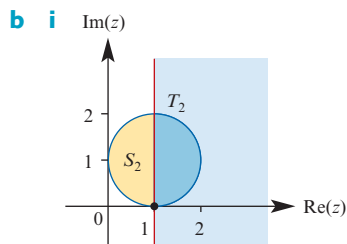
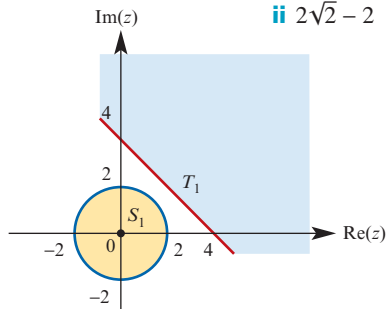

ii Maximum $\sqrt{2} + 1$; minimum 1

3 a i $a + b$ **ii** $\frac{1}{3}(a - b)$ **iii** $\frac{2}{3}(a - b)$

b $\vec{DA} = 2\vec{BD}$

4 a i 151° **ii** $\frac{1}{9}(34i + 40j + 23k)$

iii $x = 3, y = -2, z = 16$

b i $b - \frac{1}{2}a$ **ii** $\vec{OA} = 2\vec{BQ}$

5 b $4 : 1 : 3$ **c** $4i + j + 3k$

e $s = 3, t = -2$

6 a $\frac{a \cdot b}{|a||b|}$ **b** $\frac{\sqrt{(a \cdot a)(b \cdot b) - (a \cdot b)^2}}{|a||b|}$

8 c $8 : 1$

9 a i $\frac{1}{3}(a + 2b)$ **ii** $\frac{1}{6}(2b - 5a)$

b i $2 : 3$ **ii** $6 : 1$

10 a i $2c - b$ **ii** $\frac{1}{3}(a + 2b)$ **iii** $\frac{1}{5}(a + 4c)$

11 c $3 : 1$

12 a i $b - a$ **ii** $q - p$

iii $\frac{1}{2}(q + p - b - a) = \frac{1}{2}(\vec{AP} + \vec{BQ})$

13 a Since $a \times (b - 3c) = \mathbf{0}$ and $a \neq \mathbf{0}$, we must have $b - 3c = ka$ for some $k \in \mathbb{R}$

b i 1 **ii** $2\sqrt{3}$ **iii** $\pm 2\sqrt{3}$

c $\frac{1}{\sqrt{3}}$

14 b i $r = \lambda(i + j + k) + \mu(i - j + k) + \nu(i + j - k)$, where $\lambda + \mu + \nu = 1$

ii $r = \lambda(i + j + k) + \mu(-i - 2j + 3k) + \nu(2i + j - 2k)$, where $\lambda + \mu + \nu = 1$

c $r = ti + (4t - 2)j + (12 - 18t)k$

15 b i $p + \frac{(k - p \cdot n)n}{n \cdot n}$

ii $\left| \frac{(k - p \cdot n)n}{n \cdot n} \right| = \frac{|k - p \cdot n|}{|n|}$

16 a $c = a + b$

b $x = b - \lambda, y = a - b - \lambda, z = \lambda$ for $\lambda \in \mathbb{R}$

c If $b = a$ and $c = 2a$, then the solutions are $x = a - \lambda, y = -\lambda, z = \lambda$ for $\lambda \in \mathbb{R}$

17 a i $3a - b + c = -10, -a - 2b + c = -5,$
 $4a - 5b + c = -41$

ii $\begin{bmatrix} 3 & -1 & 1 & -10 \\ -1 & -2 & 1 & -5 \\ 4 & -5 & 1 & -41 \end{bmatrix}$

iii Centre $(\frac{3}{2}, -\frac{7}{2})$; radius $\frac{\sqrt{34}}{2}$

b i $3a - b + c = -10, -a - 2b + c = -5,$
 $kb + c = -k^2$

ii $\begin{bmatrix} 3 & -1 & 1 & -10 \\ -1 & -2 & 1 & -5 \\ 0 & k & 1 & -k^2 \end{bmatrix}$

iii $k \neq -\frac{7}{4}$

c $k \neq -\frac{3}{2}$

- 18 a** $z^2 - 2z + 4$
b i $2 \operatorname{cis}\left(-\frac{\pi}{3}\right)$ **ii** $4 \operatorname{cis}\left(-\frac{2\pi}{3}\right), -8$
iii $1 \pm \sqrt{3}i, -1$
c i $\sqrt{7}, \sqrt{7}$ **ii** Isosceles
- 19 a** $p = \frac{1}{3}(4 + 2\sqrt{2}i), q = \frac{1}{3}(2 + 4\sqrt{2}i)$
b i $b - a$ **ii** $\frac{1}{2}(a + b)$ **iii** $\frac{1}{3}(a + b)$
iv $\frac{1}{3}(2a - b)$ **v** $\frac{1}{3}(2b - a)$
- 20 a** $(z + 2i)(z - 2i)$ **b** $(z^2 + 2i)(z^2 - 2i)$
d $(z - 1 - i)(z + 1 + i)(z - 1 + i)(z + 1 - i)$
e $(z^2 - 2z + 2)(z^2 + 2z + 2)$
- 21 b** Circle centre $2 - i$ and radius $\sqrt{5}$
c Perpendicular bisector of line joining $1 + 3i$ and $2 - i$
- 22 a** $2 + 11i$
b i $\frac{2\sqrt{5}}{25}$ **ii** $\frac{11\sqrt{5}}{25}$
- 23 c i** 1 **ii** -1
d i $z^2 - 3z + 3 = 0$ **ii** $z^2 + 2z + 13 = 0$
e $0, 3$
- 24 a** $z^4 + z^3 + z^2 + z + 1$ **c** $\operatorname{cis}\left(-\frac{2\pi}{5}\right)$
d $\operatorname{cis}\left(\pm\frac{2\pi}{5}\right), \operatorname{cis}\left(\pm\frac{4\pi}{5}\right), 1$
e $\left(z^2 - 2\cos\left(\frac{2\pi}{5}\right)z + 1\right)\left(z^2 - 2\cos\left(\frac{4\pi}{5}\right)z + 1\right)$
- 25 a** $4, 9, -4$ **b** 5
- 26 b** $\cos(5\theta) = \cos^5 \theta (1 - 10 \tan^2 \theta + 5 \tan^4 \theta),$
 $\sin(5\theta) = \cos^5 \theta (5 \tan \theta - 10 \tan^3 \theta + \tan^5 \theta)$
- 27 a** $\operatorname{cis}(\pm\theta)$
- 28 a**

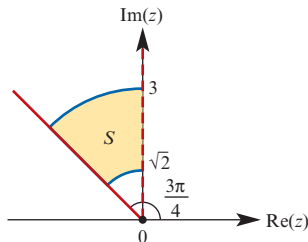

- b** $\{-1 + i, -1 + 2i, -2 + 2i\}$
c

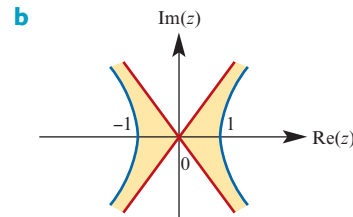
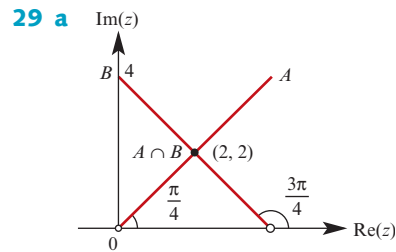
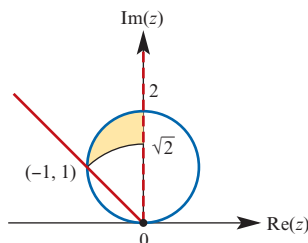

- 29 a** $\vec{OA} = i + \sqrt{\lambda}k, \vec{CA} = 2i - 3j + \sqrt{\lambda}k$
b 56° **c** $13 + 8\sqrt{3}$ since $\lambda > 0$
- 31 b i** $\vec{OX} = \frac{1}{3}(a + b + c), \vec{OY} = \frac{1}{3}(a + c + d),$
 $\vec{OZ} = \frac{1}{3}(a + b + d), \vec{OW} = \frac{1}{3}(b + c + d)$
ii $\vec{DX} = \frac{1}{3}(a + b + c) - d,$
 $\vec{BY} = \frac{1}{3}(a + c + d) - b,$
 $\vec{CZ} = \frac{1}{3}(a + b + d) - c,$
 $\vec{AW} = \frac{1}{3}(b + c + d) - a$
iii $\vec{OP} = \frac{1}{4}(a + b + c + d)$
iv $\vec{OQ} = \vec{OR} = \vec{OS} = \frac{1}{4}(a + b + c + d)$
v $Q = R = S = P$, which is the centre of the sphere that circumscribes the tetrahedron
- 32 b** $(-3 + 4s + 6t)i + (-2 - s - t)j + (-1 - s - 2t)k$
c $-mi - 2mj - 2mk$
d $4s + 6t + m = 3$
 $-s - t + 2m = 2$
 $-s - 2t + 2m = 1$
e $s = -1, t = 1, m = 1$
f $P(3, 3, 3), Q(2, 1, 1)$
g 3

Chapter 10

Exercise 10A

- 1 a** $x^4(5 \sin x + x \cos x)$ **b** $\sqrt{x}\left(\frac{\cos x}{2x} - \sin x\right)$
c $e^x(\cos x - \sin x)$ **d** $x^2 e^x(3 + x)$
e $\cos^2 x - \sin^2 x = \cos(2x)$
- 2 a** $e^x(\tan x + \sec^2 x)$ **b** $x^3(4 \tan x + x \sec^2 x)$
c $\sec^2 x \ln x + \frac{\tan x}{x}$ **d** $\sin x(1 + \sec^2 x)$
e $\sqrt{x}\left(\frac{\tan x}{2x} + \sec^2 x\right)$

- 3 a** $\frac{\ln x - 1}{(\ln x)^2}$
b $\sqrt{x} \left(\frac{\cot x}{2x} - \operatorname{cosec}^2 x \right)$
c $e^x(\cot x - \operatorname{cosec}^2 x)$ **d** $\frac{\sec^2 x}{\ln x} - \frac{\tan x}{x(\ln x)^2}$
e $\frac{\cos x}{x^2} - \frac{2 \sin x}{x^3}$
f $\sec x (\sec^2 x + \tan^2 x)$
g $\frac{-(\sin x + \cos x)}{e^x}$ **h** $-\operatorname{cosec}^2 x$
- 4 a** $2x \sec^2(x^2 + 1)$ **b** $\sin(2x)$
c $e^{\tan x} \sec^2 x$ **d** $5 \tan^4 x \sec^2 x$
e $\frac{\sqrt{x} \cos(\sqrt{x})}{2x}$ **f** $\frac{1}{2} \sec^2 x \sqrt{\cot x}$
g $x^{-2} \sin\left(\frac{1}{x}\right)$ **h** $2 \tan x \sec^2 x$
i $\frac{1}{4} \sec^2\left(\frac{x}{4}\right)$ **j** $-\operatorname{cosec}^2 x$
- 5 a** $k \sec^2(kx)$ **b** $2 \sec^2(2x) e^{\tan(2x)}$
c $6 \tan(3x) \sec^2(3x)$ **d** $e^{\sin x} \left(\frac{1}{x} + \ln x \cos x \right)$
e $6x \sin^2(x^2) \cos(x^2)$
f $e^{3x+1} \sec^2 x (3 \cos x + \sin x)$
g $e^{3x} (3 \tan(2x) + 2 \sec^2(2x))$
h $\frac{\sqrt{x} \tan(\sqrt{x})}{2x} + \frac{\sec^2(\sqrt{x})}{2}$
i $\frac{2(x+1) \tan x \sec^2 x - 3 \tan^2 x}{(x+1)^4}$
j $20x \sec^3(5x^2) \sin(5x^2)$
- 6 a** $5(x-1)^4$ **b** $\frac{1}{x}$
c $e^x (3 \sec^2(3x) + \tan(3x))$
d $-\sin x e^{\cos x}$ **e** $-12 \cos^2(4x) \sin(4x)$
f $4 \cos x (\sin x + 1)^3$
g $-\sin x \sin(2x) + 2 \cos(2x) \cos x$ **h** $1 - \frac{1}{x^2}$
i $\frac{x^2(3 \sin x - x \cos x)}{\sin^2 x}$ **j** $\frac{-(1 + \ln x)}{(x \ln x)^2}$
- 7 a** $3x^2$ **b** $4y + 10$
c $-\sin(2z)$ **d** $\sin(2x) e^{\sin^2 x}$
e $-2 \tan z \sec^2 z$ **f** $-2 \cos y \operatorname{cosec}^3 y$
- 8 a** $\frac{2}{2x+1}$ **b** $\frac{2}{2x-1}$ **c** $\cot x$ **d** $\sec x$
e $\frac{\sin^2 x - \cos^3 x}{\sin x \cos x (\cos x + \sin^2 x)}$ **f** $\operatorname{cosec} x$
g $\operatorname{cosec} x$ **h** $\frac{1}{\sqrt{x^2 - 4}}, x \neq \pm 2$ **i** $\frac{1}{\sqrt{x^2 + 4}}$
- 9 a** $\frac{1}{2}$ **b** $\frac{2}{3}$ **c** 1
- 10 a** $\left(-\frac{\pi}{3}, -\sqrt{3}\right), \left(\frac{\pi}{3}, \sqrt{3}\right)$
b $y = 4x + \frac{4\pi}{3} - \sqrt{3}, y = 4x - \frac{4\pi}{3} + \sqrt{3}$

- 11 a** $\left(-\frac{\pi}{3}, 3\sqrt{3}\right)$ is a local maximum;
 $\left(\frac{\pi}{3}, -3\sqrt{3}\right)$ is a local minimum

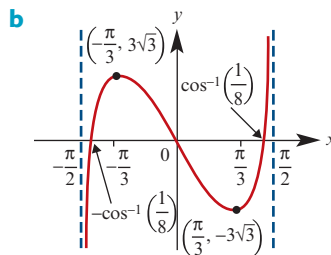

- 12 a** $\sqrt{2}e^{\frac{\pi}{4}}$ **b** $\left(-\frac{\pi}{4}, -\frac{1}{\sqrt{2}}e^{-\frac{\pi}{4}}\right)$
- 13** $\pm \frac{1}{2} \cos^{-1} \left(\frac{\sqrt{2 \tan\left(\frac{7\pi}{18}\right)}}{\tan\left(\frac{7\pi}{18}\right)} \right)$
- 14 a** $\frac{1}{4} \sin\left(\frac{x}{4}\right) \sec^2\left(\frac{x}{4}\right)$ **b** $\frac{\sqrt{2}}{4}$
c $y = \frac{\sqrt{2}}{4}(x - \pi + 4)$
- 15 a** $224(2x + 5)^6$ **b** $-4 \sin(2x)$
c $-\frac{1}{9} \cos\left(\frac{x}{3}\right)$ **d** $2 \sin x \sec^3 x$
e $16e^{-4x}$ **f** $\frac{-1}{x^2}$ **g** $-\operatorname{cosec}^2 x$
h $18 \sin(1 - 3x) \sec^3(1 - 3x)$
i $\frac{1}{9} \sec\left(\frac{x}{3}\right) \left(2 \tan^2\left(\frac{x}{3}\right) + 1 \right)$
j $\frac{1 + \cos^2\left(\frac{x}{4}\right)}{16 \sin^3\left(\frac{x}{4}\right)}$
- 16 a** $(-1, 1), (0, 1)$ **b** $\left(-\frac{1}{2}, \frac{3}{2}\right)$
- 17 a** No points of inflection
b $\left(10, \frac{1}{18}\right), \frac{-1}{432}$

Exercise 10B

- 1 a** $\frac{1}{2}$ **b** $\frac{1}{2y}$ **c** $\frac{1}{4(2y-1)}$
d e^{-y} **e** $\frac{1}{5 \cos(5y)}$ **f** y
g $\cos^2 y$ **h** $\frac{1}{3y^2 + 1}$ **i** y^2
j $\frac{1}{e^y(y+1)}$
- 2 a** $\frac{64}{3}$ **b** $\frac{4}{3}$ **c** $\frac{1}{4}$
d 1 **e** $\frac{1}{4}$ **f** $\pm \frac{1}{8}$
g $-\frac{\sqrt{3}}{3}$ **h** $\pm \frac{1}{2}$

- 3 a $\frac{1}{6(2y-1)^2}$ b $\frac{1}{2e^{2y+1}}$
 c $\frac{1}{2}(2y-1)$ d y
 4 a $\frac{1}{6\sqrt[3]{x^2}}$ b $\frac{1}{2x}$ c $\frac{1}{2}e^x$ d $\frac{1}{2}e^{x+1}$
 5 $y = \frac{1}{6}x - \frac{5}{6}$, $y = -\frac{1}{6}x + \frac{5}{6}$
 6 a $(5, -1), (12, 6)$ b $(-\frac{15}{4}, \frac{5}{2})$
 c $(-\frac{15}{4}, \frac{3}{2})$
 7 a $(2, 2)$ b 8.13°

Exercise 10C

- 1 a $\frac{1}{\sqrt{4-x^2}}$, $x \in (-2, 2)$
 b $\frac{-1}{\sqrt{16-x^2}}$, $x \in (-4, 4)$
 c $\frac{3}{9+x^2}$
 d $\frac{3}{\sqrt{1-9x^2}}$, $x \in (-\frac{1}{3}, \frac{1}{3})$
 e $\frac{-2}{\sqrt{1-4x^2}}$, $x \in (-\frac{1}{2}, \frac{1}{2})$
 f $\frac{5}{1+25x^2}$
 g $\frac{3}{\sqrt{16-9x^2}}$, $x \in (-\frac{4}{3}, \frac{4}{3})$
 h $\frac{-3}{\sqrt{4-9x^2}}$, $x \in (-\frac{2}{3}, \frac{2}{3})$
 i $\frac{10}{25+4x^2}$
 j $\frac{1}{\sqrt{25-x^2}}$, $x \in (-5, 5)$
 2 a $\frac{1}{\sqrt{-x(x+2)}}$, $x \in (-2, 0)$
 b $\frac{-1}{\sqrt{-x(x+1)}}$, $x \in (-1, 0)$ c $\frac{1}{x^2+4x+5}$
 d $\frac{-1}{\sqrt{-x^2+8x-15}}$, $x \in (3, 5)$
 e $\frac{3}{\sqrt{6x-9x^2}}$, $x \in (0, \frac{2}{3})$
 f $\frac{-3}{2x^2-2x+1}$
 g $\frac{6}{\sqrt{-3(3x^2+2x-1)}}$, $x \in (-1, \frac{1}{3})$
 h $\frac{20}{\sqrt{-5(5x^2-6x+1)}}$, $x \in (\frac{1}{5}, 1)$
 i $\frac{-10}{x^2-2x+5}$ j $\frac{-2x}{\sqrt{1-x^4}}$, $x \in (-1, 1)$
 3 a $\frac{3}{x\sqrt{x^2-9}}$ b $\frac{-5}{x\sqrt{x^2-25}}$ c $\frac{3}{x\sqrt{4x^2-9}}$

- 4 a $\frac{a}{\sqrt{1-a^2x^2}}$, $x \in (-\frac{1}{a}, \frac{1}{a})$
 b $\frac{-a}{\sqrt{1-a^2x^2}}$, $x \in (-\frac{1}{a}, \frac{1}{a})$
 c $\frac{a}{1+a^2x^2}$
 5 a $\frac{4x}{\sqrt{(1-x^2)^3}}$ b $\frac{-2x}{(1+x^2)^2}$
 c $\frac{3x}{\sqrt{(16-x^2)^3}}$ d $\frac{-27x}{\sqrt{(1-9x^2)^3}}$
 e $\frac{-96x}{(9+4x^2)^2}$

- 6 a i $[-2, 2]$ ii $[-\frac{3\pi}{2}, \frac{3\pi}{2}]$
 b $\frac{3}{\sqrt{4-x^2}}$, $x \in (-2, 2)$

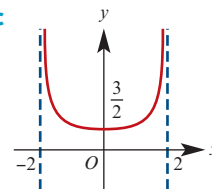

- 7 a i $[-\frac{1}{3}, \frac{1}{3}]$ ii $[0, 4\pi]$
 b $f'(x) = \frac{-12}{\sqrt{1-9x^2}}$, $x \in (-\frac{1}{3}, \frac{1}{3})$

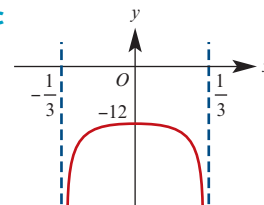

- 8 a i \mathbb{R} ii $(-\pi, \pi)$
 b $f'(x) = \frac{-12}{x^2+2x+5}$

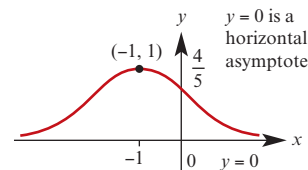

- 9 a $f'(x) = \frac{2 \sin^{-1} x}{\sqrt{1-x^2}}$, $x \in (-1, 1)$
 b $f'(x) = 0$, $x \in (-1, 1)$
 c $f'(x) = \frac{-x}{\sqrt{1-x^2}}$, $x \in (-1, 1)$
 d $f'(x) = \frac{-x}{\sqrt{1-x^2}}$, $x \in (-1, 1)$
 e $f'(x) = \frac{e^{\sin^{-1} x}}{\sqrt{1-x^2}}$, $x \in (-1, 1)$
 f $f'(x) = \frac{e^x}{1+e^{2x}}$

- 10 a 0.35 b -6.29 c $\frac{3}{5}$
 11 a $\pm \frac{\sqrt{3}}{2}$ b $\pm \frac{\sqrt{391}}{10}$ c $\pm \frac{\sqrt{5}}{3}$
 d $-1 \pm \frac{\sqrt{1599}}{20}$ e $\pm \frac{\sqrt{35}}{4}$

12 a $y = \frac{4\sqrt{3}}{3}x - \frac{\sqrt{3}}{3} + \frac{\pi}{6}$

b $y = x - \frac{1}{2} + \frac{\pi}{4}$

c $y = -2\sqrt{3}x + \frac{\sqrt{3} + \pi}{3}$

d $y = -6x + \sqrt{3} + \frac{\pi}{6}$

13 a $(-\infty, -6] \cup [6, \infty)$

b $f'(x) = \frac{6}{x\sqrt{x^2 - 36}}, x < -6 \text{ or } x > 6$

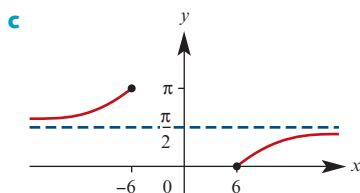

Exercise 10D

- 1 a $\frac{dr}{dt} \approx 0.00127 \text{ m/min}$
 b $\frac{dA}{dt} = 0.08 \text{ m}^2/\text{min}$
 2 $\frac{dx}{dt} \approx 0.56 \text{ cm/s}$
 3 $\frac{dy}{dt} = 39 \text{ units/s}$
 4 $\frac{dx}{dt} = \frac{3}{20\pi} \approx 0.048 \text{ cm/s}$
 5 $\frac{dv}{dt} = -\frac{5}{6} \text{ units/min}$
 6 $\frac{dA}{dt} = 0.08\pi \approx 0.25 \text{ cm}^2/\text{h}$
 7 $\frac{dc}{dt} = \frac{1}{2} \text{ cm/s}$
 8 a $\frac{dy}{dt} = \frac{1-t^2}{(1+t^2)^2}, \frac{dx}{dt} = \frac{-2t}{(1+t^2)^2}$
 b $\frac{dy}{dx} = \frac{t^2-1}{2t}$
 9 $\frac{dy}{dx} = \frac{-\sin(2t)}{1+\cos(2t)} = -\tan t$
 10 $y = \frac{\sqrt{3}}{3}x - \frac{\pi\sqrt{3}}{18} + 1$
 11 a $\frac{dy}{dt} = 12 \text{ cm/s}$ b $\frac{dy}{dt} = \pm 16 \text{ cm/s}$
 12 2.4
 13 a $\frac{-5\sqrt{6}}{2} \text{ cm/s}$ b $-4\sqrt{3} \text{ cm/s}$

- 14 $72\pi \text{ cm}^3/\text{s}$
 15 a 4 cm b 2 cm/s
 16 $\frac{7}{12\pi} \text{ cm/s}$
 17 $\frac{dV}{dt} = A \frac{dh}{dt}$
 18 a $\frac{dh}{dt} = -\frac{\sqrt{h}}{4\pi}$
 b i $\frac{dV}{dt} = -\frac{\sqrt{10}}{2} \text{ m}^3/\text{h}$ ii $\frac{dh}{dt} = -\frac{\sqrt{10}}{8\pi} \text{ m/h}$
 19 a $y = -\frac{1}{2}x + \sqrt{2}$ b $y = \frac{-\cos t}{2 \sin t}x + \frac{1}{\sin t}$
 20 a $y = \frac{\sqrt{2}}{2}x - 1$ b $y = -\sqrt{2}x + 5$
 c $y = \frac{1}{2 \sin \theta}x - \frac{\cos \theta}{\sin \theta}$
 21 a $2 \operatorname{cosec} t$ b $y = 2\sqrt{2}x + 6\sqrt{2} - 2$
 22 a $y = -\sin(t)x + 2 \tan(t)$
 b $\frac{2 \sin t}{\cos^2 t}$ c $\frac{\pi}{3}$
 23 a e^{-t} b $(1, \infty)$

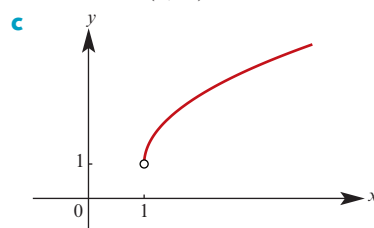

- d $4x - 2y = 1$
 24 a $\frac{3(t-3)(t-1)}{2t}, t \neq 0$
 b $(2, 4), (10, 0)$ c $\frac{3(t^2-3)}{4t^3}, t \neq 0$
 d $(4, 12\sqrt{3} - 18), (4, -12\sqrt{3} - 18)$

Exercise 10E

- 1 a
-
- b
-

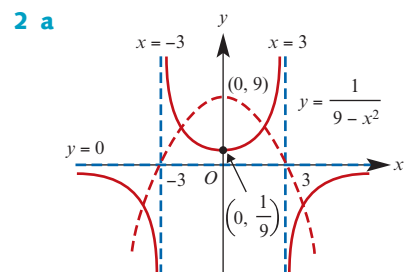
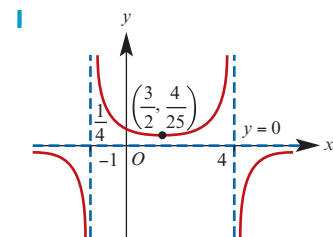
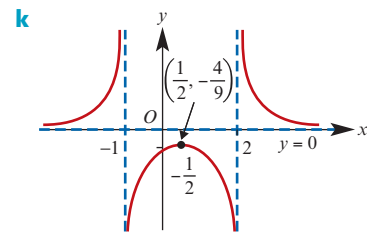
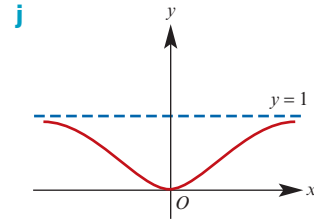
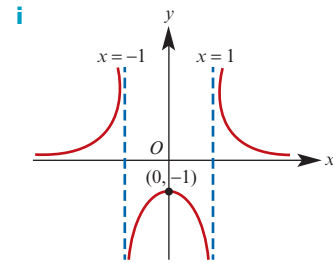
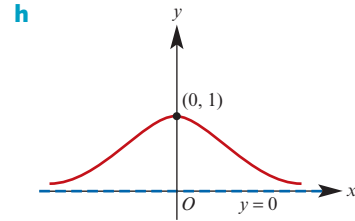
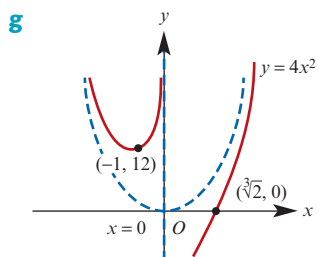
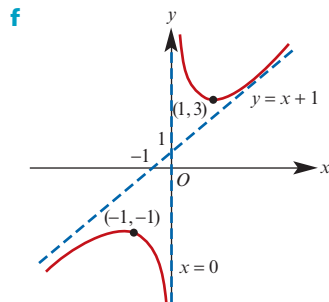
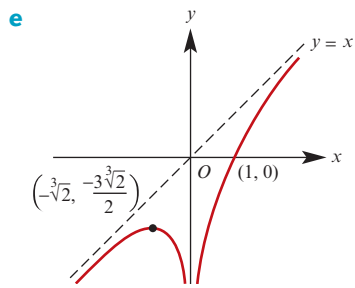
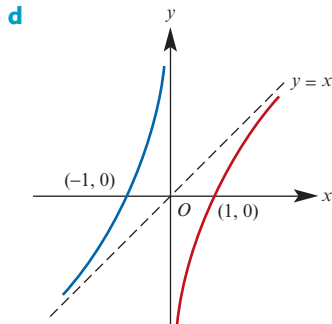
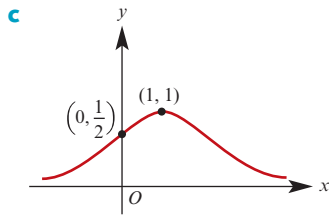

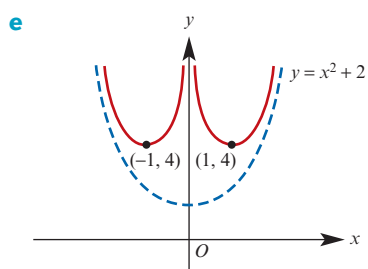
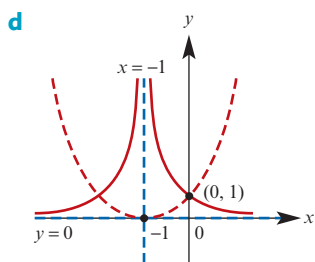
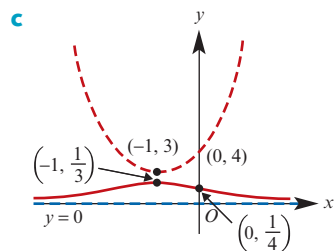
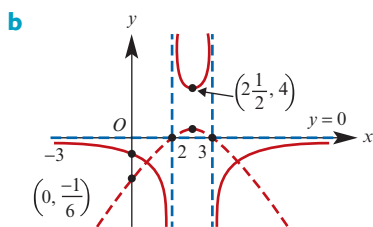

3 a Min $(\frac{1}{2}, 4)$; max $(-\frac{1}{2}, -4)$

b $y = \frac{15}{4}x + 1$

4 $x = \pm \frac{1}{2}$

5 Gradient = $\frac{1}{2}$

6 a $(1, 0), (4, 0)$ **b** $x = 0, y = x - 5$

c Min $(2, -1)$; max $(-2, -9)$

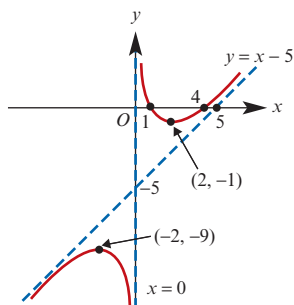

7 Least value = 3

8 Least value = 4

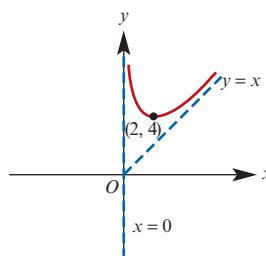

9 a Min $(3, 0)$; max $(-3, -12)$

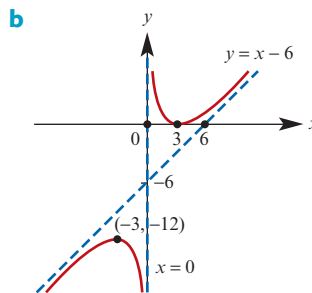

10 a Min $(\frac{1}{2}, 6)$

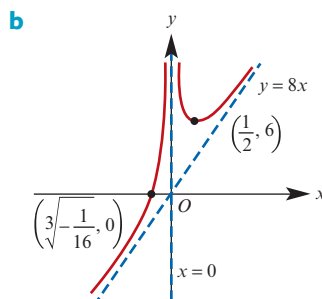

11 Asymptotes: $y = x + 3, x = 0$;
Axis intercepts: $(-2, 0), (1, 0)$;
Stationary points: local max $(-2, 0)$

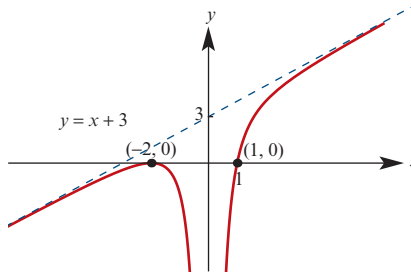

12 a $\mathbb{R} \setminus \{-\frac{1}{2}\}$ **b** $\frac{8(x^2 + x - 2)}{(2x + 1)^2}$

c Local min $(1, 4)$; local max $(-2, -8)$

d $x = -\frac{1}{2}, y = 2x - 1$ **e** $\mathbb{R} \setminus (-8, 4)$

13 a $x = 4, x = 1, y = 1$

b Local max $(2, -4)$; local min $(-2, \frac{4}{9})$

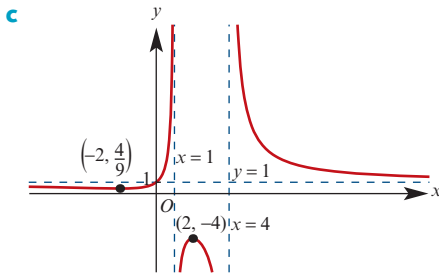

14 a $y = 1$

b Local min $(-1, \frac{1}{3})$; local max $(2, \frac{5}{3})$

c Points of inflection $(\frac{1}{2}, 1)$,
 $(\frac{1-3\sqrt{3}}{2}, \frac{3-\sqrt{3}}{3})$, $(\frac{1+3\sqrt{3}}{2}, \frac{3+\sqrt{3}}{3})$

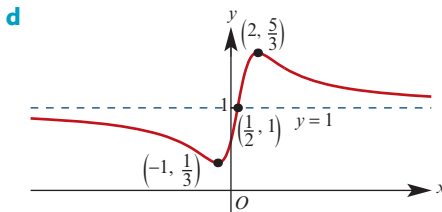

15 a

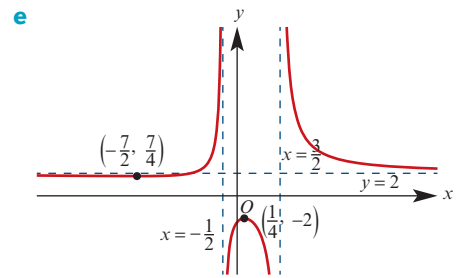
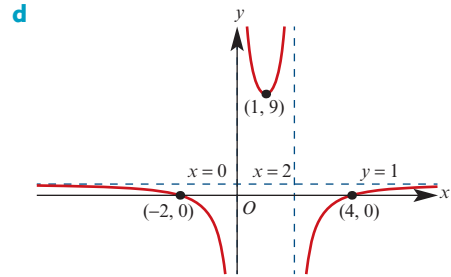
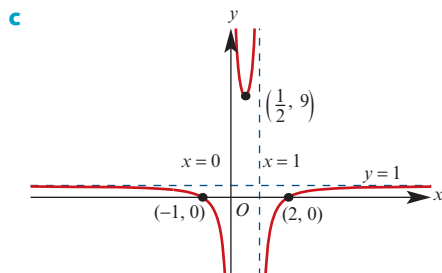
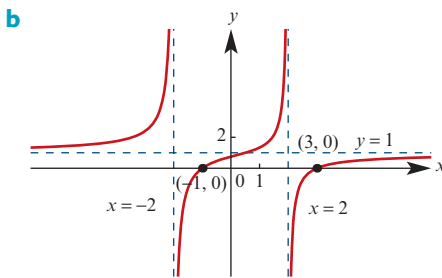
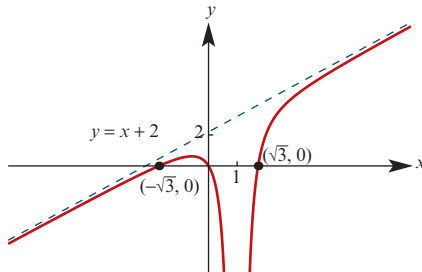

16 a $x > 2$

b $\frac{x-4}{2(x-2)^{\frac{3}{2}}}$

c $(4, 2\sqrt{2})$, local minimum

d $x = 2$

e $f(x) \rightarrow \sqrt{x}$ as $x \rightarrow \infty$

17 a $x > -\frac{1}{2}$

b 7

c $\frac{3x^2 + 3x - 6}{(2x + 1)^{\frac{3}{2}}}$

d $(1, 3\sqrt{3})$, local minimum

e $x = -\frac{1}{2}$

Exercise 10F

- 1 a x b $-\frac{2y}{x}$ c $\frac{-x^2}{y^2}$ d $\frac{2x}{3y^2}$
 e $2\sqrt{y}$ f $\frac{2-y}{x+3}$ g $\frac{2a}{y}$ h $\frac{2}{1-y}$
- 2 a $\frac{x+2}{y}$ b $\frac{-y^2}{x^2}$
 c $\frac{2(x+y)}{1-2(x+y)}$ d $\frac{y-2x}{2y-x}$
 e $\frac{2xe^y}{1-x^2e^y}$ f $\frac{-\sin(2x)}{\cos y}$
 g $\frac{\cos x - \cos(x-y)}{\cos y - \cos(x-y)}$ h $\frac{\sin y}{5y^4 - x \cos y + 6y}$
- 3 a $x + y = -2$ b $5x - 12y = 9$
 c $16x - 15y = 8$ d $y = -3$
- 4 $\frac{dy}{dx} = \frac{y}{x}$ 5 $-\frac{1}{4}$
 6 -1 7 $-\frac{2}{5}$
 8 $-\frac{7}{5}$
 9 a $\frac{dy}{dx} = \frac{-x^2}{y^2}$ c $-\frac{1}{9}$

10 $y = -1, y = 1$

11 a $\frac{dy}{dx} = \frac{-(3x^2 + y)}{x + 6y^2}$

d $k = -220$ or $k = -212$

12 a $\frac{dy}{dx} = \frac{y-x}{2y-x}$

b $(-2, -2), (2, 2)$

13 a $\frac{dy}{dx} = \frac{-3x^2}{2y}$

b $(0, -1), (0, 1)$

c $(1, 0)$

e $y = \pm\sqrt{1-x^3}$

f $(0, -1), (0, 1)$

g

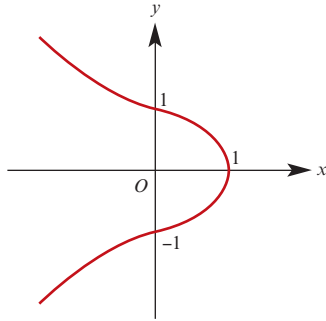

Chapter 10 review

Short-answer questions

1 a $\frac{3}{3x-4}$

b $\frac{-\sin(\ln|x|)}{x}$

c $\frac{-1}{\sqrt{-x-x^2}}$

d $\frac{1}{x^2+2x+2}$

e $\tan x + x \sec^2 x$

f $\frac{\sec^2(\tan^{-1} x)}{1+x^2} = 1$

g $\frac{-x}{\sqrt{1-x^2}}$

h $\frac{1}{\sqrt{x-x^2}}$

2 a $2 \sec^2 x \tan x$

b $\frac{\sec^2 x - 2}{2-x^2} = -\operatorname{cosec}^2 x + \sec^2 x$

c $\frac{\sin^2 x}{(1-x^2)^{\frac{3}{2}}}$

d $e^x(\cos e^x - e^x \sin e^x)$

3 $-\frac{1}{2}$

4 a $(0, 0), (4, -256)$

b $(2, 0)$

c $(\frac{\sqrt{3}}{3}, \frac{7}{4}), (-\frac{\sqrt{3}}{3}, \frac{7}{4})$

5 a i $2 \cos(2x) - 6 \sin(2x)$

ii $-4 \sin(2x) - 12 \cos(2x)$

6 a $\frac{1-\ln x}{x^2}$

b $\frac{1}{x^2-2x+2}$

c $\frac{1}{e^x+1}$

d $\frac{2\sqrt{\sin y + \cos y}}{\cos y - \sin y}$

e $\frac{1}{\sqrt{1+x^2}}$

f $\frac{e^x}{\sqrt{1-e^{2x}}}$

7 a

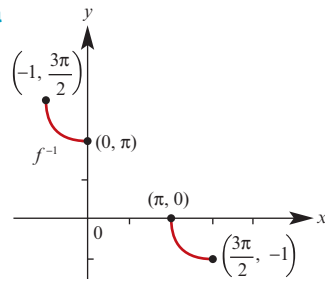

b $-\frac{1}{\sqrt{1-x^2}}$

c $(-\frac{\sqrt{3}}{2}, \frac{4\pi}{3})$

8 a

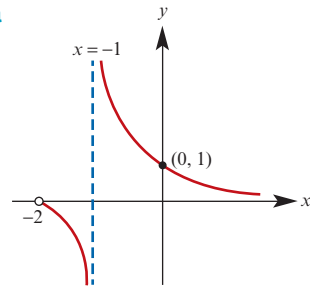

b

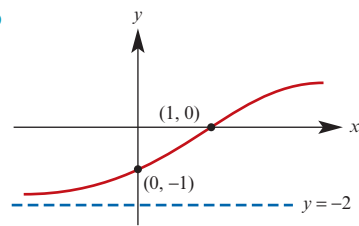

9 a i

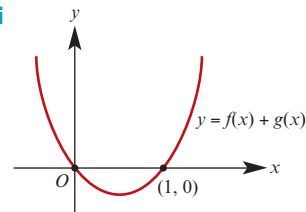

ii

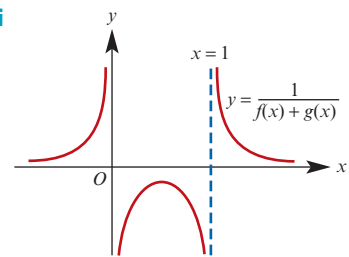

iii

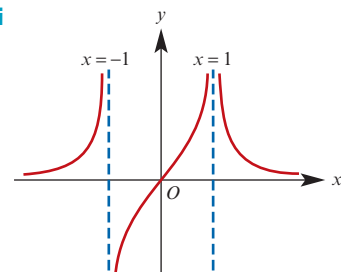

b $f(x) = x^2 - 1$, $g(x) = (x - 1)^2$

c i $f(x) + g(x) = 2x^2 - 2x$

ii $\frac{1}{f(x) + g(x)} = \frac{1}{2x^2 - 2x}$

iii $\frac{1}{f(x)} + \frac{1}{g(x)} = \frac{2x}{(x - 1)^2(x + 1)}$

10 a -1

b $\frac{-(x + 1)}{y + 3}$

c $\frac{-2y^2}{x^2}$

d $\frac{-(x + 1)}{y - 3}$

11 a 324 cm/s

b 36 cm/s

Multiple-choice questions

1 E **2** E **3** D **4** A **5** B

6 D **7** C **8** B **9** D **10** C

Extended-response questions

1 b

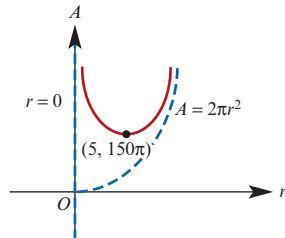

c $150\pi \text{ cm}^2$

2 a $A = 80x + 50 + \frac{2000}{x}$

b

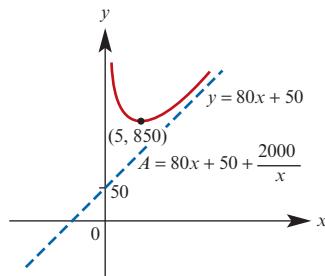

c Min surface area = 850 cm^2 , $x = 5$, $y = 5$

d Min surface area = $\frac{2000}{k} + 40\sqrt{10k} \text{ cm}^2$,

$x = y = \frac{10\sqrt{10k}}{k}$

3 a $A = \frac{\sqrt{3}}{2}x^2 + 3xy$ **b** $y = \frac{8000\sqrt{3}}{3x^2}$

c $A = \frac{\sqrt{3}}{2}x^2 + \frac{8000\sqrt{3}}{x}$

d

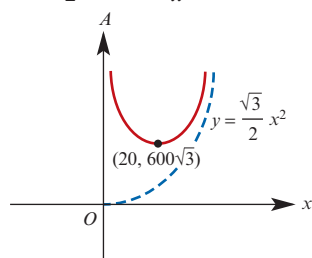

e Min surface area = $600\sqrt{3} \text{ cm}^2$

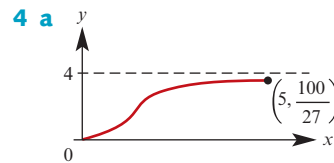

b i $\frac{16x}{(2 + x^2)^2}$ **ii** $\frac{16}{(2 + x^2)^2} \left(1 - \frac{4x^2}{2 + x^2}\right)$

c $\frac{\sqrt{6}}{3}$

d

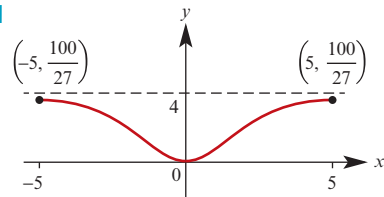

5 a i $y = \frac{100}{x^2}$

ii $S = 60x^2 + \frac{3000}{x}$

iii $S \text{ (cm}^2\text{)}$

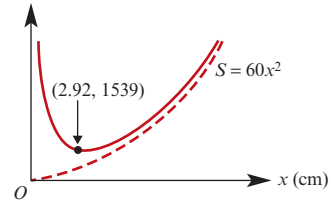

b $521\frac{13}{27} \text{ cm}^2/\text{s}$

c 1.63 cm or 4.78 cm

6 a $A = \frac{p\sqrt{p^2 + 4}}{2} - p$

b i $\frac{dA}{dp} = \frac{p^2}{2\sqrt{p^2 + 4}} + \frac{\sqrt{p^2 + 4}}{2} - 1$

ii

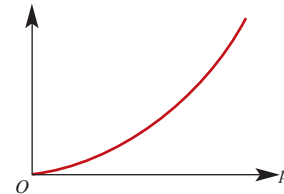

iii 10.95

c i 0.315 sq. units/s **ii** 0.605 sq. units/s

iii 9.800 sq. units/s **iv** 15.800 sq. units/s

7 a $3ax^2 + 2bx + c$

b $6ax + 2b$

c $b^2 \leq 3ac$

d i $x = -\frac{b}{3a}$ **ii** $\max a < 0$, $\min a > 0$

e $-\frac{b}{3}$

f i $b^2 < 4c$ **ii** $3c < b^2 < 4c$

8 a ii $\frac{4(3x^2 - 1)}{(1 + x^2)^3}$

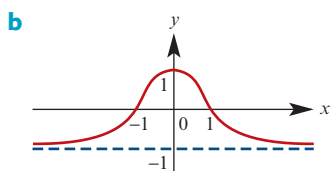

Horizontal asymptote at $y = -1$

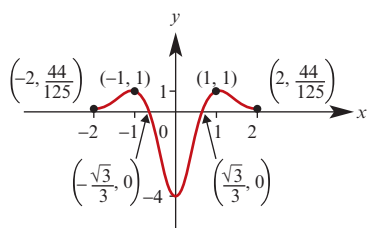
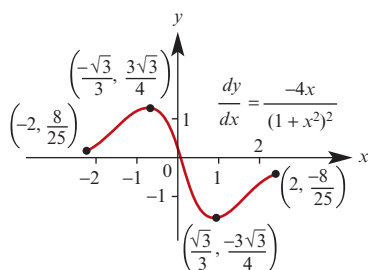
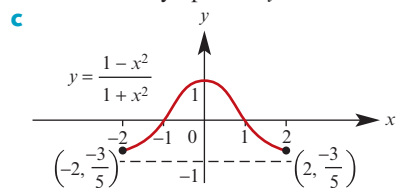

$$\frac{d^2y}{dx^2} = \frac{4(3x^2 - 1)}{(1 + x^2)^3}$$

d i $y = x + 1, y = -x + 1$

9 a i $\frac{dV}{dh} = \frac{3000\pi h}{1 - h}$

ii $\frac{dV}{dh} \text{ (m}^3\text{/m)}$

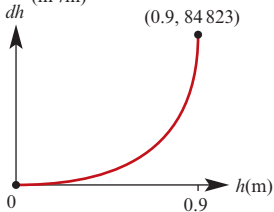

b i 13 219 litres

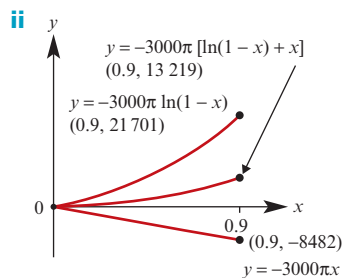

c 0.0064 m/min

10 a i $f'(x) = 0$ **ii** $f(x) = \frac{\pi}{2}$ **iii** $f(x) = -\frac{\pi}{2}$

b i $\frac{dy}{dx} = -\operatorname{cosec}^2 x$ **ii** $\frac{dy}{dx} = -(1 + y^2)$

c $\frac{-1}{1 + x^2}$

d $-\operatorname{cosec}^2 x + \sec^2 x$

11 a $f'(x) = -\frac{16}{x^3} + \frac{16}{x}$ **b** $f''(x) = \frac{48}{x^4} - \frac{16}{x^2}$

c $(1, 16 \ln 2 - 24)$ **d** $x = \sqrt{3}$ **e** $(1, \infty)$

f $x = 3.55$

g

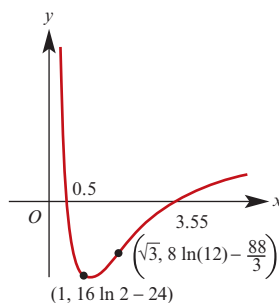

12 b i $\left(3, \frac{2 - 2 \cos \theta}{\sin \theta}\right)$

c i $M = \left(\frac{3}{2 \cos \theta}, \frac{1}{\sin \theta}\right)$

ii $\frac{9}{4x^2} + \frac{1}{y^2} = 1$

d i $y = \frac{2 \sin \theta}{3 \cos \theta} x + \frac{6}{3 \cos \theta}$

ii $Z = (3(\cos \theta - \sin \theta), 2(\cos \theta + \sin \theta))$

iii $(2x + 3y)^2 + (3y - 2x)^2 = 144$

13 a $\left| \frac{ab}{\sin(2\theta)} \right|$

b $\theta = (2n + 1)\frac{\pi}{4}, n \in \mathbb{Z}$; minimum area = ab

14 b $Q = \left(\frac{a}{\sec \theta - \tan \theta}, \frac{b}{\sec \theta - \tan \theta}\right)$;

$R = \left(\frac{a}{\sec \theta + \tan \theta}, \frac{-b}{\sec \theta + \tan \theta}\right)$

c Midpoint = $(a \sec \theta, b \tan \theta)$

15 a $\frac{9 \sin \theta \cos \theta}{4}$

b Maximum area = $\frac{9}{8}$ when $\theta = \frac{\pi}{4}$

c $M = \left(\frac{3 \cos \theta}{4}, \frac{-3 \sin \theta}{2}\right)$

d $\frac{16x^2}{9} + \frac{4y^2}{9} = 1$

16 a $\frac{x^2}{4} + y^2 = 1$

Chapter 11

Exercise 11A

- 1 a $-\frac{1}{2} \cos\left(2x + \frac{\pi}{4}\right)$ b $\frac{1}{\pi} \sin(\pi x)$
 c $-\frac{3}{2\pi} \cos\left(\frac{2\pi x}{3}\right)$ d $\frac{1}{3} e^{3x+1}$ e $\frac{1}{5} e^{5(x+4)}$
 f $-\frac{3}{2x}$ g $\frac{3}{2} x^4 - \frac{2}{3} x^3 + 2x^2 + x$
- 2 a 0 b 20 c $\frac{1}{3} + \frac{1}{6}$
 d $\frac{5}{24}$ e $\frac{1}{\sqrt{2}} + \frac{\pi^2}{16}$ f $\frac{e^3}{3} + \frac{1}{6}$
 g 0 h 0 i 1
- 3 a $\frac{1}{2} \ln|2x - 5|$ b $\frac{1}{2} \ln\left(\frac{3}{5}\right)$ c $\frac{1}{2} \ln\left(\frac{7}{9}\right)$
- 4 a $\frac{1}{3} \ln\left(\frac{5}{2}\right)$ b $\frac{1}{3} \ln\left(\frac{5}{11}\right)$ c $\frac{1}{3} \ln\left(\frac{7}{4}\right)$
- 5 a $\frac{(3x+2)^6}{18}$ b $\frac{1}{3} \ln|3x-2|$
 c $\frac{2}{9}(3x+2)^{\frac{3}{2}}$ d $-\frac{1}{3(3x+2)}$
 e $3x - 2 \ln|x+1|$ f $\frac{2}{3} \sin\left(\frac{3x}{2}\right)$
 g $\frac{3}{20}(5x-1)^{\frac{4}{3}}$ h $2x - 5 \ln|x+3|$
- 6 a $f(x) = 2x, F(x) = x^2 + 3$
 b $f(x) = 4x^2, F(x) = \frac{4}{3}x^3$
 c $f(x) = -2x^2 + 8x - 8,$
 $F(x) = -\frac{2}{3}x^3 + 4x^2 - 8x + \frac{28}{3}$
 d $f(x) = e^{-x}, F(x) = e^{-x} + 3$
 e $f(x) = 2 \sin x, F(x) = 2 - 2 \cos x$
 f $f(x) = \frac{2}{4+x^2}, F(x) = \tan^{-1}\left(\frac{x}{2}\right) + \frac{\pi}{2}$

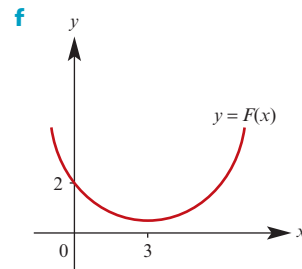
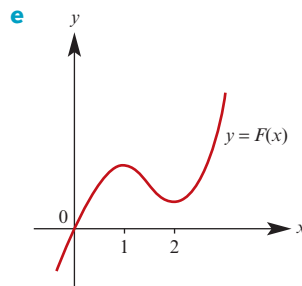
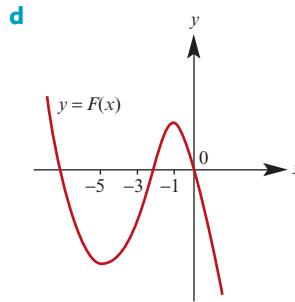
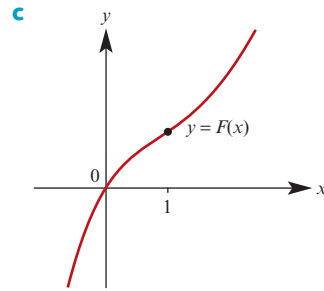
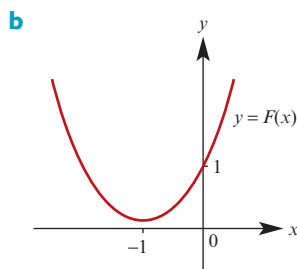
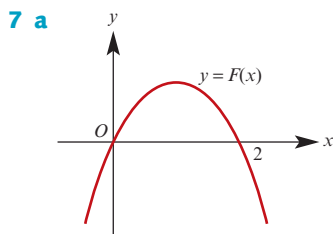

Exercise 11B

- 1 a $\sin^{-1}\left(\frac{x}{3}\right) + c$ b $\frac{1}{\sqrt{5}} \tan^{-1}\left(\frac{x}{\sqrt{5}}\right) + c$
 c $\tan^{-1}(t) + c$ d $5 \sin^{-1}\left(\frac{x}{\sqrt{5}}\right) + c$
 e $\frac{3}{4} \tan^{-1}\left(\frac{x}{4}\right) + c$ f $\frac{1}{2} \sin^{-1}\left(\frac{x}{2}\right) + c$
 g $10 \sin^{-1}\left(\frac{t}{\sqrt{10}}\right) + c$ h $\frac{1}{12} \tan^{-1}\left(\frac{4t}{3}\right) + c$
 i $\frac{\sqrt{2}}{2} \sin^{-1}\left(\frac{x\sqrt{10}}{5}\right) + c$
 j $\frac{7}{\sqrt{3}} \tan^{-1}\left(\frac{y}{\sqrt{3}}\right) + c$

2 a $\frac{\pi}{2}$ **b** $\frac{\pi}{2}$ **c** $\frac{5\pi}{6}$ **d** $\frac{3\pi}{10}$
e $\frac{\pi}{8}$ **f** $\frac{\pi}{16}$ **g** $\frac{\pi}{6}$ **h** $\frac{\pi}{8}$
i $\frac{\pi}{2}$ **j** $\frac{1}{\sqrt{3}} \tan^{-1}(2\sqrt{3})$

Exercise 11C

1 a $\frac{(x^2 + 1)^4}{4} + c$ **b** $-\frac{1}{2(x^2 + 1)} + c$
c $\frac{1}{4} \sin^4 x + c$ **d** $-\frac{1}{\sin x} + c$
e $\frac{1}{12}(2x + 1)^6 + c$ **f** $\frac{5}{3}(9 + x^2)^{\frac{3}{2}} + c$
g $\frac{1}{12}(x^2 - 3)^6 + c$ **h** $-\frac{1}{4(x^2 + 2x)^2} + c$
i $-\frac{1}{3(3x + 1)^2} + c$ **j** $2\sqrt{1 + x} + c$
k $\frac{1}{15}(x^3 - 3x^2 + 1)^5 + c$
l $\frac{3}{2} \ln(x^2 + 1) + c$ **m** $-\frac{3}{2} \ln|2 - x^2| + c$

2 a $\tan^{-1}(x + 1) + c$
b $\frac{2\sqrt{3}}{3} \tan^{-1}\left(\frac{\sqrt{3}(2x - 1)}{3}\right) + c$
c $\sin^{-1}\left(\frac{x + 2}{5}\right) + c$ **d** $\sin^{-1}(x - 5) + c$
e $\sin^{-1}\left(\frac{x + 3}{7}\right) + c$
f $\frac{\sqrt{3}}{6} \tan^{-1}\left(\frac{\sqrt{3}(x + 1)}{2}\right) + c$

3 a $-\frac{1}{2}(2x + 3)^{\frac{3}{2}} + \frac{1}{10}(2x + 3)^{\frac{5}{2}} + c$
b $\frac{2(1 - x)^{\frac{5}{2}}}{5} - \frac{2(1 - x)^{\frac{3}{2}}}{3} + c$
c $\frac{4}{9}(3x - 7)^{\frac{3}{2}} + \frac{28}{3}(3x - 7)^{\frac{1}{2}} + c$
d $\frac{4}{25}(3x - 1)^{\frac{5}{2}} + \frac{10}{27}(3x - 1)^{\frac{3}{2}} + c$
e $2 \ln|x - 1| - \frac{1}{x - 1} + c$
f $\frac{2}{45}(3x + 1)^{\frac{5}{2}} + \frac{16}{27}(3x + 1)^{\frac{3}{2}} + c$
g $\frac{3}{7}(x + 3)^{\frac{7}{3}} - \frac{3(x + 3)^{\frac{4}{3}}}{4} + c$
h $\frac{5}{4} \ln|2x + 1| + \frac{7}{4(2x + 1)} + c$
i $\frac{2}{105}(x - 1)^{\frac{3}{2}}(15x^2 + 12x + 8)$
j $\frac{2\sqrt{x - 1}}{15}(3x^2 + 4x + 8) + c$

Exercise 11D

1 a $\frac{61}{3}$ **b** $\frac{1}{16}$ **c** $\frac{1}{3}$ **d** $\frac{25}{114}$
e $\frac{4}{15}$ **f** $\ln 2$ **g** $\frac{4}{3}$ **h** 1
i $\frac{1}{2}$ **j** $\ln 2$ **k** $\ln\left(\frac{\sqrt{6}}{2}\right)$ **l** $\ln\left(\frac{15}{8}\right)$
m $\ln\left(\frac{e + 1}{e}\right) = \ln(e + 1) - 1$

Exercise 11E

1 a $\frac{1}{2}x - \frac{1}{4} \sin(2x) + c$
b $\frac{1}{32} \sin(4x) - \frac{1}{4} \sin(2x) + \frac{3}{8}x + c$
c $2 \tan x - 2x + c$ **d** $-\frac{1}{6} \cos(6x) + c$
e $\frac{1}{2}x - \frac{1}{8} \sin(4x) + c$ **f** $\frac{1}{2} \tan(2x) - x + c$
g $\frac{1}{8}x - \frac{1}{32} \sin(4x) + c$
h $\frac{1}{2} \sin(2x) + c$ **i** $-\cot x - x + c$
j $\frac{1}{2} \sin(2x) - \frac{1}{6} \sin^3(2x) + c$

2 a $\tan x$ ($c = 0$) **b** $\frac{1}{2} \tan(2x)$ ($c = 0$)
c $2 \tan\left(\frac{1}{2}x\right)$ ($c = 0$) **d** $\frac{1}{k} \tan(kx)$ ($c = 0$)
e $\frac{1}{3} \tan(3x) - x$ ($c = 0$)
f $2x - \tan x$ ($c = 0$) **g** $-x$ ($c = 0$)
h $\tan x$ ($c = 0$)

3 a $\frac{\pi}{4}$ **b** $\frac{1}{2} + \ln\left(\frac{\sqrt{2}}{2}\right) = \frac{1}{2} - \frac{1}{2} \ln 2$
c $\frac{1}{3}$ **d** $\frac{1}{4} + \frac{3\pi}{32}$ **e** $\frac{4}{3}$ **f** $\frac{\pi}{4}$
g $\frac{\pi}{24} + \frac{\sqrt{3}}{64}$ **h** 1

4 a $\sin x - \frac{\sin^3 x}{3} + c$
b $\frac{4}{3} \cos^3\left(\frac{x}{4}\right) - 4 \cos\left(\frac{x}{4}\right) + c$
c $\frac{1}{2}x + \frac{1}{16\pi} \sin(8\pi x) + c$
d $7 \sin t \left(\cos^2 t + \frac{3}{5} \sin^4 t - \frac{1}{7} \sin^6 t\right) + c$
e $\frac{1}{5} \sin(5x) - \frac{1}{15} \sin^3(5x) + c$
f $3x - 2 \sin(2x) + \frac{1}{4} \sin(4x) + c$
g $\frac{1}{48} \sin^3(2x) - \frac{1}{64} \sin(4x) + \frac{x}{16} + c$
h $\sin x - \frac{2 \sin^3 x}{3} + \frac{\sin^5 x}{5} + c$

Exercise 11F

- 1 a $\frac{2}{x-1} + \frac{3}{x+2}$ b $\frac{1}{x+1} - \frac{2}{2x+1}$
 c $\frac{2}{x+2} + \frac{1}{x-2}$ d $\frac{1}{x+3} + \frac{3}{x-2}$
 e $\frac{3}{5(x-4)} - \frac{8}{5(x+1)}$
 2 a $\frac{2}{x-3} + \frac{9}{(x-3)^2}$
 b $\frac{4}{1+2x} + \frac{2}{1-x} + \frac{3}{(1-x)^2}$
 c $\frac{-4}{9(x+1)} + \frac{4}{9(x-2)} + \frac{2}{3(x-2)^2}$
 3 a $\frac{-2}{x+1} + \frac{2x+3}{x^2+x+1}$ b $\frac{x+1}{x^2+2} + \frac{2}{x+1}$
 c $\frac{x-2}{x^2+1} - \frac{1}{2(x+3)}$
 4 $3 + \frac{3}{x-1} + \frac{2}{x-2}$
 5 $\frac{1}{x-10} - \frac{1}{x-1}; \ln\left|\frac{x-10}{x-1}\right| + c$
 6 $x^2 - 4x + 12 - \frac{32}{x+2} + \frac{17}{(x+2)^2};$
 $\frac{x^3}{3} - 2x^2 + 12x - \frac{17}{x+2} - 32 \ln|x+2| + c$
 7 $\frac{7}{x+2} - \frac{13}{(x+2)^2}; 7 \ln|x+2| + \frac{13}{x+2} + c$
 8 $\frac{5}{18(x-4)} - \frac{5x}{18(x^2+2)} - \frac{10}{9(x^2+2)};$
 $\frac{1}{36}\left(5 \ln\left(\frac{(x-4)^2}{x^2+2}\right) - 20\sqrt{2} \arctan\left(\frac{\sqrt{2}x}{2}\right)\right) + c$
 9 a $\ln\left|\frac{x-2}{x+5}\right| + c$ b $\ln\left|\frac{(x-2)^5}{(x-1)^4}\right| + c$
 c $\frac{1}{2} \ln|(x+1)(x-1)^3| + c$
 d $2x + \ln\left|\frac{x-1}{x+1}\right| + c$
 e $2 \ln|x+2| + \frac{3}{x+2} + c$
 f $\ln|(x-2)(x+4)^3| + c$
 10 a $\ln\left|\frac{(x-3)^3}{x-2}\right| + c$
 b $\ln|(x-1)^2(x+2)^3| + c$
 c $\frac{x^2}{2} - 2x + \ln|(x+2)^{\frac{1}{4}}(x-2)^{\frac{3}{4}}| + c$
 d $\ln((x+1)^2(x+4)^2) + c$
 e $\frac{x^3}{3} - \frac{x^2}{2} - x + 5 \ln|x+2| + c$
 f $\frac{x^2}{2} + x + \ln\left|\frac{(x-1)^4}{x^3}\right| + c$
 11 a $\frac{1}{2}\left(\ln\left(\frac{x^2+2}{(x+1)^2}\right) + 2\sqrt{2} \arctan\left(\frac{\sqrt{2}x}{2}\right)\right)$
 b $\frac{1}{2} \ln\left(\frac{(x+1)^2}{x^2+1}\right) - \frac{1}{x+1}$

- c $\frac{1}{5} \ln((x^2+4)|x-1|^{13}) + \frac{16}{5} \arctan\left(\frac{x}{5}\right) - \frac{1}{x-1}$
 d $\frac{1}{2} \ln\left(\frac{x^2+4}{(x-2)^2}\right) - 8 \arctan\left(\frac{x}{2}\right) - \frac{18}{x-2}$
 e $2 \ln\left(\frac{(x+2)^2}{x^2+2}\right) + 4\sqrt{2} \arctan\left(\frac{\sqrt{2}x}{2}\right)$
 f $\frac{1}{2} \ln\left|\frac{x-1}{x+1}\right| + \frac{3x^2+9x+10}{3(x+1)^3}$
 12 a $\ln\left(\frac{4}{3}\right)$ b $\ln\left(\frac{4}{3}\right)$ c $\frac{1}{3} \ln\left(\frac{625}{512}\right)$
 d $1 + \ln\left(\frac{32}{81}\right)$ e $\ln\left(\frac{10}{3}\right)$ f $\ln 4 + 4$
 g $\frac{1}{2} \ln\left(\frac{7}{4}\right)$ h $\ln\left(\frac{2}{3}\right)$ i $\frac{1}{4} \ln\left(\frac{1}{3}\right)$
 j $5 \ln\left(\frac{3}{4}\right) - \ln 2$
 13 a $-\frac{5}{4}(2 \ln 2) - \pi$ b $2 \ln 2 + \pi + \sqrt{3}$
 c $1 - \frac{\pi}{2}$ d $-\frac{1}{3}(3 \ln 3) + \pi\sqrt{3}$
 14 a $\frac{3}{x-2} - \frac{1+2x}{x^2+x+1}$ b $\ln\left(\frac{|x-2|^3}{x^2+x+1}\right) + c$
 c $2 \ln\left(\frac{9}{8}\right)$

Exercise 11G

- 1 a $(-x-1)e^{-x}$ b $x \ln x - x$
 c $\sin x - x \cos x$ d $x \arccos(x) - \sqrt{1-x^2}$
 e $\frac{1}{9} \cos(3x) + \frac{1}{3} x \sin(3x)$
 f $\ln|\cos x| + x \tan x$
 g $-\frac{1}{2}x^2 + x \tan x + \ln|\cos x|$
 h $x \arcsin(2x) + \frac{1}{2}\sqrt{1-4x^2}$
 i $x \arctan x - \frac{1}{2} \ln(1+x^2)$
 j $(-x-2)e^{-x}$
 k $\frac{1}{2}(-x + \arctan x + x^2 \arctan x)$
 l $\frac{1}{4}x^2(2 \ln x - 1)$ m $\frac{1}{9}x^3(3 \ln x - 1)$
 n $2\sqrt{x}(\ln x - 2)$ o $(x+2)e^x$
 p $\frac{1}{36}x^6(6 \ln x - 1)$ q $\frac{1}{4}(2x-1)e^{2x+1}$
 r $\frac{1}{4}x^2(2 \ln(2x) - 1)$
 2 a $-(x^2+2x+2)e^{-x}$
 b $(2-x^2) \cos x + 2x \sin x$
 3 a $\frac{1}{2}e^x(\sin x - \cos x)$
 b $\frac{1}{13}e^{2x}(3 \sin(3x) + 2 \cos(3x))$
 c $-\frac{1}{10}e^{3x}(\cos x - 3 \sin x)$
 d $-\frac{2}{5}e^x\left(\cos\left(\frac{x}{2}\right) - 2 \sin\left(\frac{x}{2}\right)\right)$

- 4 a $\frac{1}{4}(1 + 3e^4)$ b $-\frac{\pi}{2}$ c $-\frac{1}{8}$
 d $\frac{2}{9}(1 + 2e^3)$ e $-12 + 38\sqrt{2} - 8\sqrt{2}\pi$
 f $\frac{-2 + 5e^3}{27e}$ g $\ln(12) - 1$
 h $\frac{1}{4}(5e^4 - 1)$ i $3 \ln(27) - \frac{26}{9}$

Exercise 11H

- 1 $p = \frac{4}{3}$ 2 $\frac{1}{24}$
 3 $e - 1 - \ln\left(\frac{1+e}{2}\right)$ 4 $\frac{9}{64}$
 5 $\frac{1}{3} \ln 5$ 6 $c = \frac{3}{2}$
 7 $-\frac{1}{18} \cos^6(3x) + c$ 8 $p = \left(\frac{3}{2}\right)^{\frac{1}{2}}$
 9 $p = \frac{8}{5}$
 10 a $-\frac{1}{2 \sin^2 x} + c$ b $\frac{1}{20}(4x^2 + 1)^{\frac{5}{2}} + c$
 c $\frac{1}{3} \sin^3 x - \frac{1}{5} \sin^5 x + c$
 d $\frac{1}{1 - e^x} + c$
 11 1
 12 a $\frac{1}{2} \tan^{-1}\left(\frac{x+1}{2}\right) + c$ b $\frac{1}{3} \sin^{-1}(3x) + c$
 c $\frac{1}{2} \sin^{-1}(2x) + c$ d $\frac{1}{6} \tan^{-1}\left(\frac{2x+1}{3}\right) + c$
 13 a $-\frac{1}{2x\sqrt{x-1}}$ b $\frac{\pi}{6}$
 14 a $\frac{1}{3}(f(x))^3 + c$ b $-\frac{1}{f(x)} + c$
 c $\ln(f(x)) + c$ d $-\cos(f(x)) + c$
 15 $\frac{dy}{dx} = \frac{8-3x}{2\sqrt{4-x}}$; $4\sqrt{2}$
 16 $a = 2, b = -3, c = -1$; $x^2 - 3x + \frac{1}{x-2} + c$
 17 a $\frac{\pi}{8}$ b 42 c 0 d $\ln 2$
 e $1 - \frac{\pi}{4}$ f $\ln\left(\frac{3}{2}\right)$
 18 a $\frac{1}{2} \sin^2 x + c$ b $-\frac{1}{4} \cos(2x) + c$
 19 a $\frac{dy}{dx} = \frac{1}{\sqrt{x^2+1}}$;
 $\int \frac{1}{\sqrt{x^2+1}} dx = \ln|x + \sqrt{x^2+1}| + c$
 b $\frac{dy}{dx} = \frac{1}{\sqrt{x^2-1}}$
 20 a $\frac{1}{2} \tan^{-1}\left(\frac{x}{2}\right), c = 0$ b $\frac{1}{4} \ln\left|\frac{x+2}{2-x}\right|, c = 0$
 c $4 \ln|x| + \frac{1}{2}x^2, c = 0$ d $\frac{1}{2} \ln(4 + x^2), c = 0$
 e $x - 2 \tan^{-1}\left(\frac{x}{2}\right), c = 0$

- f $\frac{1}{2} \tan^{-1}(2x), c = 0$ g $\frac{1}{3}(4 + x^2)^{\frac{3}{2}}, c = 0$
 h $\frac{2}{5}(x+4)^{\frac{5}{2}} - \frac{8}{3}(x+4)^{\frac{3}{2}}, c = 0$
 i $-2\sqrt{4-x}, c = 0$ j $\sin^{-1}\left(\frac{x}{2}\right), c = 0$
 k $-8\sqrt{4-x} + \frac{2}{3}(4-x)^{\frac{3}{2}}, c = 0$
 l $-\sqrt{4-x^2}, c = 0$

- 21 a $\frac{1}{4}(3e^4 - e^2)$ b $\frac{1}{4}(e^2 + 1)$ c $-\pi$
 22 $c = \frac{5}{2}, d = \frac{3}{2}$
 23 a $f'(x) = -(n-1) \sin^2 x \cos^{n-2} x + \cos^n x$
 c i $\frac{3\pi}{16}$ ii $\frac{5\pi}{32}$ iii $\frac{\pi}{32}$ iv $\frac{4}{3}$
 24 a $\frac{1}{2-n}(x+1)^{2-n} - \frac{1}{1-n}(x+1)^{1-n} + c$
 b $\frac{1}{n+2} + \frac{1}{n+1}$
 25 a $\frac{1}{3}a^2 + a + 1$ b $-\frac{3}{2}$
 26 a $\frac{a^2 + b^2}{(a \cos x + b \sin x)^2}$ b $\frac{1}{ab}$
 27 a $U_n + U_{n-2} = \frac{1}{n-1}$
 28 a 1 c $\frac{\pi}{4}$

Chapter 11 review

Short-answer questions

- 1 a $\frac{1}{6} \sin(2x)(3 - \sin^2(2x))$
 b $\frac{1}{4}(\ln(4x^2 + 1) + 6 \tan^{-1}(2x))$
 c $\frac{1}{4} \ln\left|\frac{1+2x}{1-2x}\right|$
 d $-\frac{1}{4}\sqrt{1-4x^2}$
 e $-\frac{1}{4}x + \frac{1}{16} \ln\left|\frac{1+2x}{1-2x}\right|$
 f $-\frac{1}{6}(1 - 2x^2)^{\frac{3}{2}}$
 g $\frac{1}{2}x - \frac{1}{4} \sin\left(2x - \frac{2\pi}{3}\right)$ h $(x^2 - 2)^{\frac{1}{2}}$
 i $\frac{1}{2}x - \frac{1}{12} \sin(6x)$
 j $\frac{1}{6} \cos(2x)(\cos^2(2x) - 3)$
 k $2(x+1)^{\frac{3}{2}}\left(\frac{1}{5}(x+1) - \frac{1}{3}\right)$ l $\frac{1}{2} \tan x$
 m $\frac{x}{e} - \frac{1}{3e^{3x+1}}$ n $\frac{1}{2} \ln|x^2 - 1|$ o $\frac{x}{8} - \frac{\sin 4x}{32}$
 p $\frac{1}{2}x^2 - x + \ln|1 + x|$

- 2 a $\frac{1}{3} - \frac{\sqrt{3}}{8}$ b $\frac{1}{2} \ln 3$
 c $\frac{1}{3} \left(\frac{5\sqrt{5}}{8} - 1 \right)$ d $\frac{1}{6} \ln \left(\frac{7}{4} \right)$
 e $2 + \ln \left(\frac{32}{81} \right)$ f $\frac{2}{3}$ g $\frac{\pi}{6}$
 h $\frac{\pi}{4}$ i $\frac{\pi}{4}$ j $\frac{\pi}{16}$
 k $\ln \left(\frac{3\sqrt{2}}{2} \right)$ l 6

3 $\frac{1}{2} \ln |x^2 + 2x + 3| - \frac{\sqrt{2}}{2};$
 $-\frac{\sqrt{2}}{2} \tan^{-1} \left(\frac{\sqrt{2}(x+1)}{2} \right) + c$

4 a $\frac{1}{2\sqrt{x(1-x)}}; 2 \sin^{-1}(\sqrt{x}) + c$

b $\frac{2x}{\sqrt{1-x^4}}; \sin^{-1}(x^2) + c$

5 a $\sin^{-1} x + \frac{x}{\sqrt{1-x^2}}; x \sin^{-1} x + \sqrt{1-x^2} + c$

b $\ln |x| + 1; x \ln |x| - x + c$

c $\tan^{-1} x + \frac{x}{1+x^2}; x \tan^{-1} x - \frac{1}{2} \ln(1+x^2) + c$

6 a $-\frac{1}{8} \cos(4x)$ b $\frac{1}{9}(x^3 + 1)^3$

c $\frac{-1}{2(3 + 2 \sin \theta)}$ d $-\frac{1}{2} e^{1-x^2}$

e $\tan(x+3) - x$ f $\sqrt{6+2x^2}$

g $\frac{1}{3} \tan^3 x$ h $\frac{1}{3 \cos^3 x}$

i $\frac{1}{3} \tan(3x) - x$

7 a $\frac{8}{15}$ b $-\frac{39}{4}$ c $\frac{1}{2}$

d $\frac{2}{3}(2\sqrt{2}-1)$ e $\frac{\pi}{2}$ f $\frac{1}{3} \ln \left(\frac{1}{9} \right)$

8 $\frac{1}{2} \left(x^2 + \frac{1}{x} \right)^{-\frac{1}{2}} (2x - x^{-2}); 3\sqrt{2}$

9 a 1, 1 b 3, 2

10 a $\frac{1}{4} e^{-2x} (\sin(2x+3) - \cos(2x+3))$

b $x \tan x + \ln(\cos x)$

c $\frac{2}{37} e^{3x} \left(\sin \left(\frac{x}{2} \right) + 6 \cos \left(\frac{x}{2} \right) \right)$

11 a $\frac{1}{9}(8 \ln 8 - 7)$ b $\frac{1}{2} (\ln 2)^2$

c $\frac{1}{4}(1 - 3e^{-2})$

Multiple-choice questions

- 1 E 2 C 3 C 4 D 5 A
 6 D 7 C 8 A 9 D

Chapter 12

Exercise 12A

1 Area = $\sin^{-1} \left(\frac{2}{3} \right)$ square units

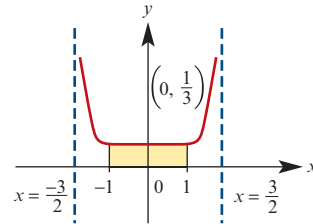

2 Area = $\frac{9\pi}{4}$ square units

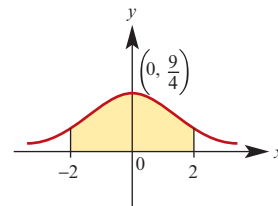

3 Area = $2\frac{2}{3}$ square units

4 Area = $\frac{3}{2} + 2 \ln 2$ square units

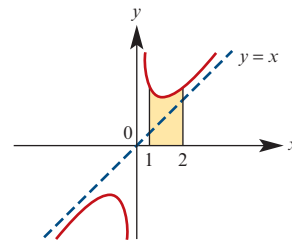

5 a Area = $\frac{\pi}{4} - \ln \sqrt{2}$ square units

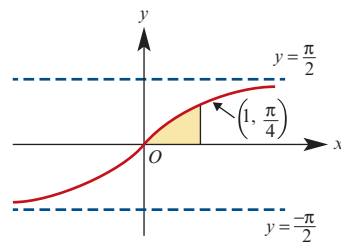

b Area = $\frac{1}{2}$ square units

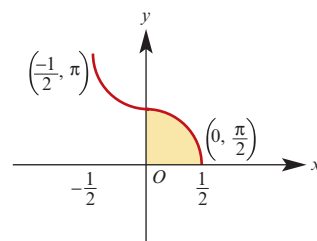

c Area = $\frac{\pi}{2}$ square units

d Area = $\pi - 2$ square units

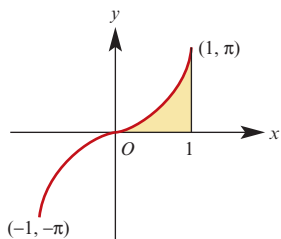

e Area = $\pi - 2$ square units

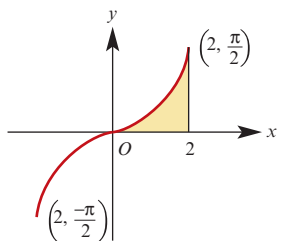

f Integral = $\frac{5\pi}{6} - \sqrt{3}$

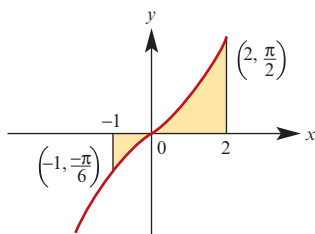

6 Area = $\frac{4}{3} \ln 5$ square units

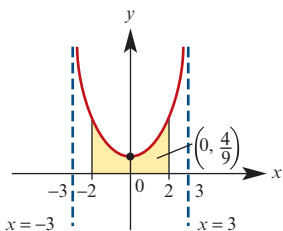

7 a (0, 1) **b** $y = -1$ **c** $\pi - 2$ square units

8 a $(0, -\frac{4}{3}), (-4, 0), (1, 0)$

b $y = x, x = -3$

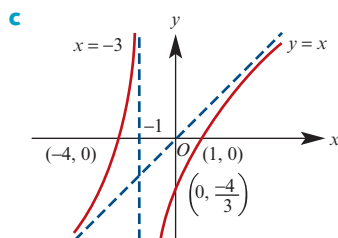

d Area = $31\frac{1}{2} + 4 \ln \frac{4}{11}$ square units

9 a $\mathbb{R} \setminus \{1, 2\}$

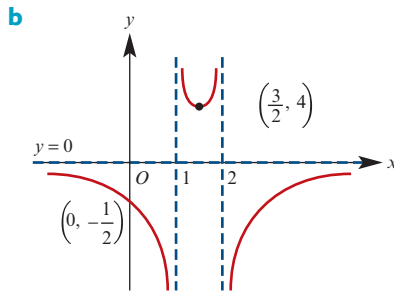

c $\mathbb{R}^- \cup [4, \infty)$

d Area = $-\ln(\frac{3}{4}) = \ln(\frac{4}{3})$ square units

10 $\int_0^{\frac{1}{2}} \frac{-3}{\sqrt{1-x^2}} dx = -\frac{\pi}{2}$

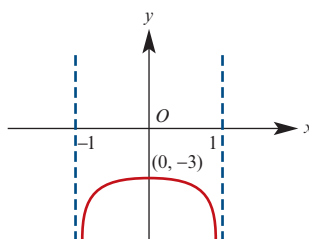

11 $\frac{\pi}{12}$ square units

12 Area = $\frac{\pi\sqrt{3}}{3} - \ln 2$ square units

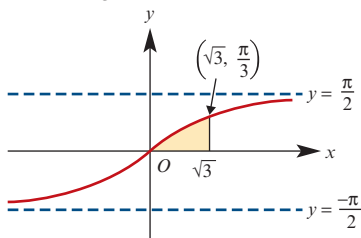

13 1 square unit

14 $\frac{2}{3}$ square units

15 $\frac{1}{3}$ square units

16 Area = $6 \ln 2$ square units

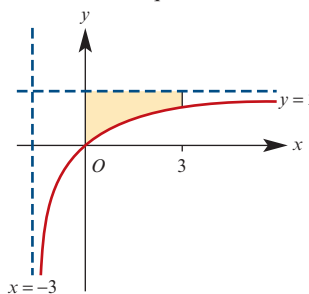

17 b $(\frac{1}{4}, 2\frac{2}{3})$ local minimum

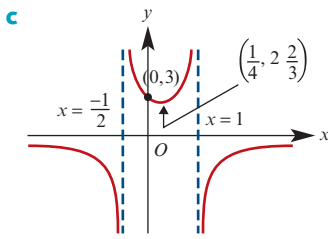

c $\frac{3}{2} - \ln 4$ square units

Exercise 12B

1 (3, 3), (2, 0); $\frac{1}{3}$ square units

2 $\frac{1}{3}$ square units

3 a $\frac{17}{24}$ square units b $\frac{5}{6}$ square units

4 Area = $8 \ln 3 - \frac{22}{3}$ square units

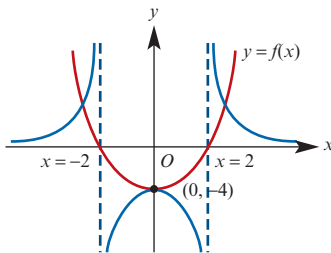

5 a e^2

6 a $4\frac{1}{2}$ square units b $\frac{11}{6}$ square units

c $\frac{11}{6}$ square units

7 a Area = 4 square units

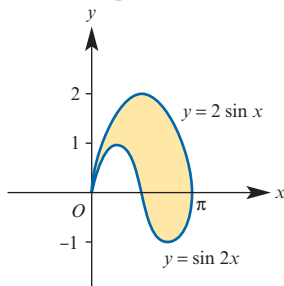

b Area = $2\frac{1}{2}$ square units

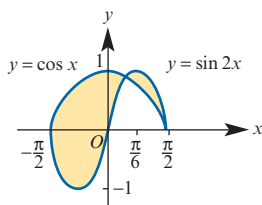

c Area = $2\frac{1}{6}$ square units

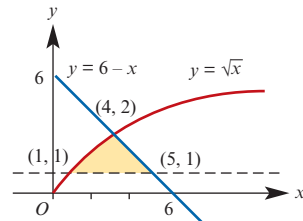

d Area = $\pi - 2$ square units

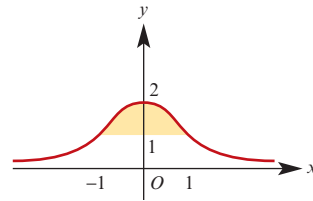

e Area = $\frac{\pi}{12} - 1 + \frac{\sqrt{3}}{2}$ square units

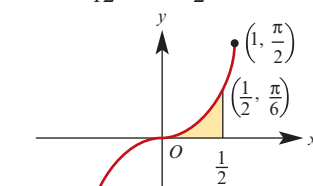

f Area = $2 + \frac{\pi}{3} - \sqrt{3}$ square units

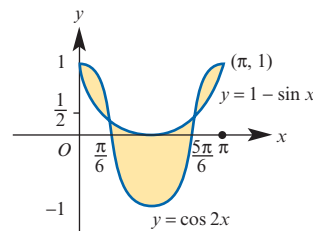

g Area ≈ 4.161 square units

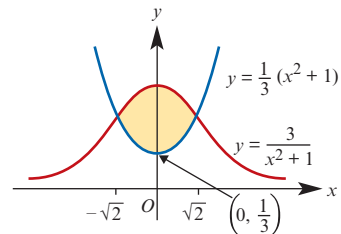

8 a Area = 1 square unit

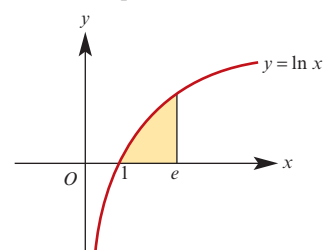

b Area = $\ln 2 - \frac{1}{2}$ square units

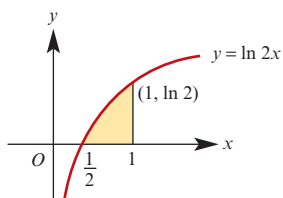

9 a $f'(x) = e^x + xe^x$ **b** $x = -1$
c

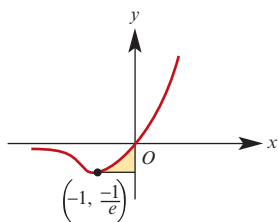

d $y = -\frac{1}{e}$ **e** Area = $\frac{3}{e} - 1$ square units
 Note: As $f'(x) = e^x + xe^x$,
 $\int xe^x dx = xe^x - e^x + c$

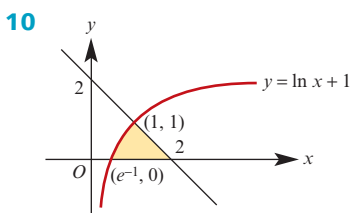

a $y = 2 - x$
b Area = $\frac{1}{2} + \frac{1}{e}$ square units

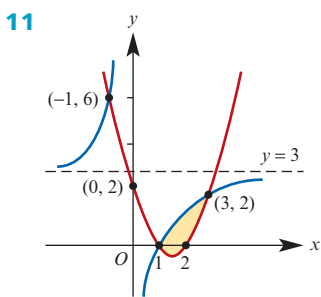

Area = $\frac{16}{3} - 3 \ln 3$ square units

13 a $(-2\sqrt{2}, 1), (2\sqrt{2}, 1)$ **b** 33.36

14 $\frac{9}{2}$

15 3.772

16 a $a = 4, b = 2\sqrt{5}$ **b** 5.06

17 4

Exercise 12C

- 1 a** $\frac{9\pi}{4}$ **b** $\frac{324 - 108\sqrt{6}}{5}$
c $3 \ln(10) - 2 \arctan\left(\frac{1}{3}\right) + \pi - 6$
- 2 a** $\frac{\pi}{4} - \frac{1}{2}$ **b** $2 \ln(2) - 1$ **c** $\frac{\pi}{8} - \frac{\ln(2)}{4}$
- 3 a** 4.24 **b** 3.14 **c** 1.03 **d** 0.67 **e** 1.95
f 0.66 **g** 0.64 **h** 0.88 **i** 1.09 **j** 0.83
- 4 a** $\ln x$ **b** $-\ln x$ **c** $e^x - 1$
d $1 - \cos x$ **e** $\tan^{-1}(x) + \frac{\pi}{4}$
f $\sin^{-1}(x)$

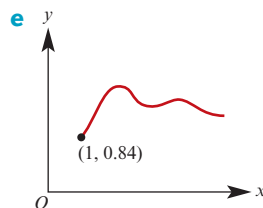
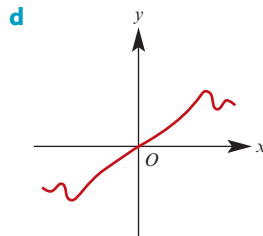
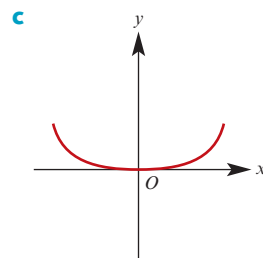
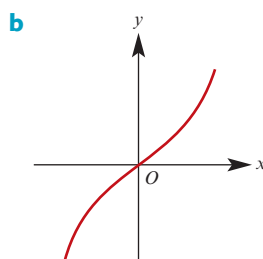
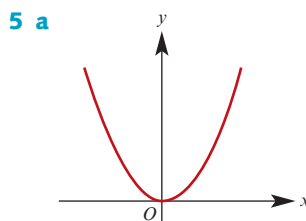

Exercise 12D

- 1 Area = $\frac{32}{3}$ square units;
Volume = 8π cubic units
- 2 a 8π cubic units b $\frac{364\pi}{3}$ cubic units
- c $\frac{343\pi}{6}$ cubic units d $\frac{\pi^2}{4}$ cubic units
- e $\frac{\pi}{2}(e^4 - 1)$ cubic units
- f 36π cubic units
- 3 $\frac{2\pi}{3}$ cubic units
- 4 a $\frac{3\pi}{4}$ cubic units b $\frac{28\pi}{15}$ cubic units
- c 2π cubic units d $\frac{4\pi a^3}{3}$ cubic units
- e 36π cubic units f 18π cubic units
- 5 $\frac{1088\pi}{15}$ cubic units 6 $\frac{\pi}{2}$ cubic units
- 7 $\frac{21\pi}{4}$ cubic units 8 $\frac{3\pi}{10}$ cubic units
- 9 $\frac{32\pi}{3}$ cubic units

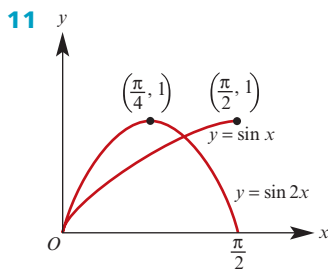

- 11
- 12 b = $\frac{4}{13}$ 13 $\frac{7\pi}{6}$ cubic units
- 14 a $\frac{16\pi}{3}$ b $\pi\left(\frac{e^4}{2} - 4e^2 + \frac{23}{2}\right)$
- 15 a $\frac{e}{2} - 1$ b $\frac{\pi}{6}(e^2 - 3)$
- 16 $\frac{16\pi}{15}$ cubic units 17 $\frac{\pi^2}{2}$ cubic units
- 18 $\frac{7\pi}{10}$ cubic units 19 $\frac{19\pi}{6}$ cubic units
- 20 $\pi\left(\ln 2 - \frac{1}{2}\right)$ cubic units
- 22 $2\pi(4 - \pi)$ cubic units
- 24 a $\frac{\pi}{3} \tan^{-1}\left(\frac{4}{3}\right)$ b 4π
- 25 $176\,779 \text{ cm}^3$
- 26 a $\frac{4\pi ab^2}{3}$ b $\frac{4\pi a^2 b}{3}$
- 27 a $x + y = 8$
- b i $\frac{64\pi}{3}$ ii $\frac{64\pi}{3}$

28 a

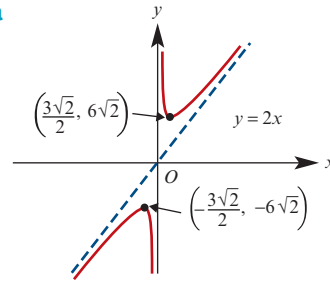

- b $\frac{482\pi}{3}$ cubic units
- 29 2.642 cubic units
- 30 $4\pi\left(\frac{4\pi}{3} - \sqrt{3}\right)$ cubic units

Exercise 12E

- 1 a 0.6065 b 0.6321
- 2 a 0.6514 b 0.2325
- 3 a $E(X) = 10, \text{sd}(X) = 10$ b 0.3679
- 4 a $f(t) = \frac{1}{6}e^{-t/6}$ for $t \geq 0$ b 0.3935
- c 0.4346
- 5 a 0.7769 b 0.3679 c 0.1447
- 6 0.5507
- 7 a 0.2636 b 0.5134
- 8 a 5 minutes b 5 minutes c 0.3935
- 9 a 0.0183 b $\text{Var}(X) = 0.25$
- c 0.0159
- 10 a $F(x) = 1 - e^{-x/4}$ for $x \geq 0$ b $m = 2.773$
- 11 0.4866
- 12 a 0.5488 b $E(X) = 500$ hours
- c $m = 346.57$ hours
- 13 $m = 2.77$ minutes
- 14 a 0.2231 b 0.6065

Chapter 12 review

Short-answer questions

- 1 $\frac{1}{3}$
- 2 a $\frac{\pi}{2} - 1$ b 1
- 3 a π b $\frac{\pi}{8}(\pi - 2)$ c $\frac{\pi}{8}(\pi + 2)$
- d $\frac{2048\pi}{15}$ e 40π
- 4 $\frac{119\pi}{6}$
- 5 a 12π b $\frac{20\sqrt{10}\pi}{3} - \frac{2\pi}{3}$

6 Volume = 2π

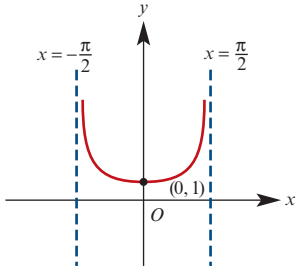

7 a $(0, 0), (2, 4)$

b $\frac{16\pi}{3}$

8 a

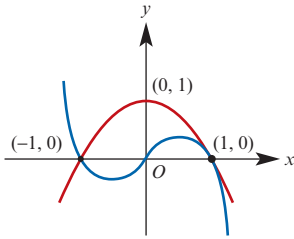

b $\frac{4}{3}$

9 a $A = (-1, 1), B = (1, 1), C = (0, \sqrt{2})$

b $\frac{44\pi}{15}$

10 a

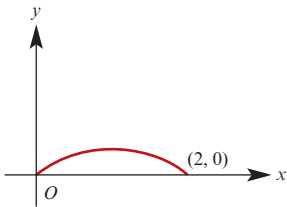

b $\frac{4}{3}$

c $\frac{16\pi}{15}$

11 a i $\frac{\pi b^5}{5}$ ii $\frac{\pi b^4}{2}$

b $b = 2.5$ or $b = 0$

12 a

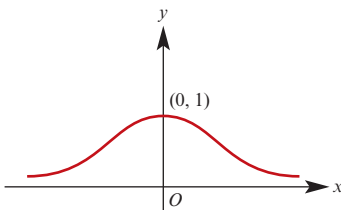

b $\frac{dy}{dx} = \frac{-8x}{(4x^2 + 1)^2}, x + y = 1$ c $\frac{\pi - 3}{8}$

13 a

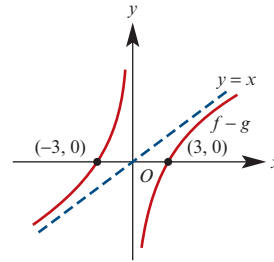
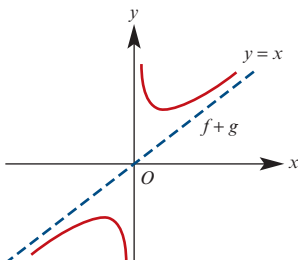

b $18 \ln 3$

14 Area = $7.5 - 4 \ln 4$

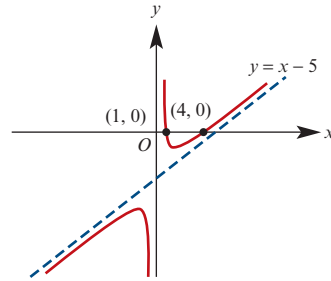

15 Area = $\frac{1}{2} - \frac{1}{3} \ln 4$

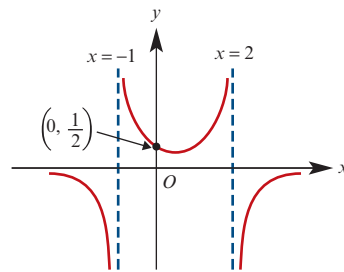

16 e^{-2}

17 a $F(x) = 1 - e^{-\frac{x}{8}}$ for $x \geq 0$

b $m = 8 \ln 2$

Multiple-choice questions

- 1 C 2 D 3 B 4 B 5 B
6 A 7 E 8 C 9 C 10 E
11 B 12 D 13 C 14 E

Extended-response questions

1 a

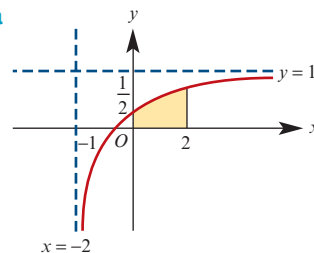

b $2 - \ln 2$ square units

c $2\pi \left(\frac{9}{8} - \ln 2 \right)$ cubic units

2 a $f'(x) = \frac{x}{1+x^2} + \tan^{-1} x$

b $\frac{\pi}{4} - \frac{1}{2} \ln 2$

c $\frac{1}{2} \ln 2$ square units

d i $g'(x) = \frac{2 \tan^{-1} x}{1+x^2}$

iii

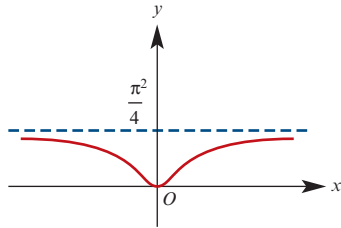

e $\pi \left(\frac{\pi}{2} - 1 \right)$ cubic units

3 a i $\ln x + 1; x \ln x - x + c$

ii $(\ln x)^2 + 2 \ln x; x(\ln x)^2 - 2x \ln x + 2x + c$

b

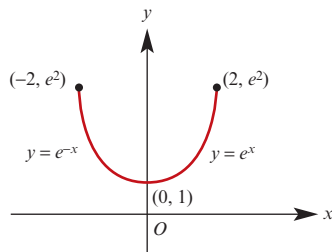

c $V = 2\pi(e^2 - 1) \text{ cm}^3 \approx 40 \text{ cm}^3$

4 a 0.1353 b 0.0900 c 0.9502

d $L = \ln\left(\frac{3}{4}\right) \approx 0.2231$ years e 0.6723

5 a $\frac{\pi}{2}$ cubic units

b $\frac{4R}{\pi}$ units per second

c i $\frac{\pi}{8}$ cubic units ii $\frac{\sqrt{2}}{2}$ units

6 b i $a = 1$ ii $\frac{2\sqrt{2}}{3}$

c $\frac{\pi a}{2(a^2 + 1)}$ cubic units

7 a

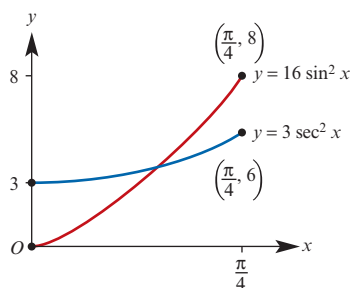

b $\left(\frac{\pi}{6}, 4 \right)$ c $3\sqrt{3} - \frac{4\pi}{3}$

8 a $a = 1; f(x) = \ln(x-1) + 1$

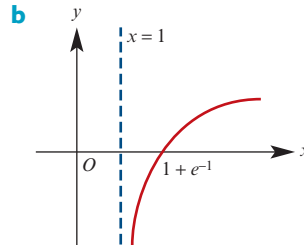

c $\text{dom } f^{-1} = \mathbb{R}; \text{ran } f^{-1} = (1, \infty)$

d $2 - e^{-1}$ e e^{-1}

10 a $a = 2\pi$

b i $\text{dom } f^{-1} = [-3, 3]; \text{ran } f^{-1} = [0, 2\pi]$

ii $f^{-1}(x) = 2 \cos^{-1}\left(\frac{x}{3}\right)$

iii

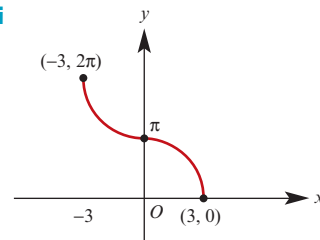

c $-\frac{2}{3}$

d $V_1 = V_2 = \frac{9\pi^2}{2}$ cubic units

11 a Area = $\pi(r^2 - y^2)$

12 a $\frac{4\pi ab^2}{3}$ b $4\sqrt{3}\pi a^2 b$

13 b $\frac{\pi}{6} - \frac{3}{16}$

c $\frac{\pi}{2} \left(\frac{-3}{16} + \ln 3 \right) = \pi \left(\frac{-3}{32} + \ln(\sqrt{3}) \right)$

14 a $\frac{\pi}{3}$ b $k = \frac{\sqrt{3}}{3}; \frac{2\pi\sqrt{3}}{27}$ cubic units

15 a i $d = 0$

$125a + 25b + 5c = 1$

$1000a + 100b + 10c = 2.5$

$27\,000a + 900b + 30c = 10$

ii $a = \frac{-7}{30\,000}, b = \frac{27}{2000}, c = \frac{83}{600}, d = 0$

b $\frac{273}{2}$

c i $V = \frac{\pi}{900\,000\,000}$

$\times \int_0^{30} (-7x^3 + 405x^2 + 4150x)^2 dx$

ii $\frac{362\,083\pi}{400}$

d i $w = 16.729\,335$

ii $\frac{197\,881\,099\pi}{250\,000} \approx 2487$

e $\left(\frac{135}{7}, \frac{1179}{196} \right)$

- 16 a** $\frac{\pi H}{3}(a^2 + ab + b^2) \text{ cm}^3$
b $\frac{\pi H}{24}(7a^2 + 4ab + b^2) \text{ cm}^3$
c $V = \frac{\pi H(r^3 - a^3)}{3(b-a)}$
d i $\frac{dV}{dr} = \frac{\pi H r^2}{b-a}$ **ii** $h = \frac{H(r-a)}{b-a}$
e i $\frac{dV}{dr} = 2\pi r^2$
ii $\frac{dr}{dt} = \frac{1}{96\pi}$; $\frac{dh}{dt} = \frac{1}{48\pi}$

Chapter 13

Exercise 13A

- 1 a** $y = 4e^{2t} - 2$ **b** $y = x \ln|x| - x + 4$
c $y = \sqrt{2x+79}$ **d** $y - \ln|y+1| = x - 3$
e $y = \frac{1}{2}x^4 - \frac{1}{2}x + 2$ **f** $y = \frac{11}{5}e^{2x} + \frac{4}{5}e^{-2x}$
g $x = 3 \sin(3t) + 2 \cos(3t) + 2$
3 $4\sqrt{2}$
4 $-2, 5$
5 $a = 0, b = -1, c = 1$
6 $a = 0, b = \frac{1}{2}$
7 $a = 1, b = -6, c = 18, d = -24$

Exercise 13B

- 1 a** $y = \frac{1}{3}x^3 - \frac{3}{2}x^2 + 2x + c$
b $y = \frac{1}{2}x^2 + 3x - \ln|x| + c$
c $y = 2x^4 + 4x^3 + 3x^2 + x + c$
d $y = 2\sqrt{x} + c$
e $y = \frac{1}{2} \ln|2t-1| + c$
f $y = -\frac{1}{3} \cos(3t-2) + c$
g $y = -\frac{1}{2} \ln|\cos(2t)| + c$
h $x = -\frac{1}{3}e^{-3y} + c$
i $x = \sin^{-1}\left(\frac{y}{2}\right) + c$
j $x = \frac{1}{y-1} + c$
2 a $y = \frac{1}{4}x^5 + cx + d$
b $y = \frac{4}{15}(1-x)^{\frac{5}{2}} + cx + d$
c $y = -\frac{1}{4} \sin\left(2x + \frac{\pi}{4}\right) + cx + d$

- d** $y = 4e^{\frac{x}{2}} + cx + d$
e $y = -\ln|\cos x| + cx + d$
f $y = -\ln|x+1| + cx + d$
3 a $y = \frac{x-1}{x}$ **b** $y = 1 - e^{-x}$
c $y = \frac{1}{2}x^2 - 4 \ln|x+1|$ **d** $y = \frac{1}{2} \ln|x^2-4|$
e $y = \frac{1}{3}(x^2-4)^{\frac{3}{2}} - \frac{95\sqrt{3}}{12}$
f $y = \sin^{-1}\left(\frac{x}{2}\right) + \frac{\pi}{6}$ **g** $y = \frac{1}{4} \ln\left|\frac{2+x}{2-x}\right| + 2$
h $y = \frac{1}{2} \tan^{-1}\left(\frac{x}{2}\right) + \frac{\pi}{4}$
i $y = \frac{2}{5}(4-x)^{\frac{5}{2}} - \frac{8}{3}(4-x)^{\frac{3}{2}} + 8$
j $y = \ln\left(\frac{e^x+1}{2}\right)$

- 4 a** $y = e^{-x} - e^x + 2x$ **b** $y = x^2 - 2x^3$
c $y = x^2 + \frac{1}{4} \sin(2x) - 1$
d $y = \frac{1}{2}x^2 - 2x + \ln|x| + 3$
e $y = x - \tan^{-1}x + \frac{\pi}{4}$ **f** $y = 8x^3 + 12x^2 + 6x$
g $y = \sin^{-1}\left(\frac{x}{2}\right)$

Exercise 13C

- 1 a** $y = \frac{1}{3}(Ae^{3x} + 5)$ **b** $y = \frac{1}{2}(Ae^{-2x} + 1)$
c $y = \frac{1}{2} - \frac{1}{2} \ln|2c-2x|$
d $y = \tan^{-1}(x-c)$ **e** $y = \cos^{-1}(e^{c-x})$
f $y = \frac{1-Ae^{2x}}{1+Ae^{2x}}$ **g** $y = \tan(x-c)$
h $x = \frac{5}{3}y^3 + y^2 + c$ **i** $y = \frac{1}{4}(x-c)^2$
2 a $y = e^{x+1}$ **b** $y = e^{x-4} - 1$
c $y = e^{2x-2}$ **d** $y = -\frac{1}{2}(e^{2x} + 1)$
e $x = y - e^{-y} + 1$
f $y = 3 \cos x, -\pi < x < 0$
g $y = \frac{3(e^{6x-7} - 1)}{e^{6x-7} + 1}$
h $y = \frac{1}{3} \tan(3x), -\frac{\pi}{6} < x < \frac{\pi}{6}$
i $y = \frac{4}{e^{-x} - 2}$
3 a $y = (3(x-c))^{\frac{1}{3}}$ **b** $y = \frac{1}{2}(Ae^{2x} + 1)$

Exercise 13D

- 1 a $\frac{dx}{dt} = 2t + 1, \quad x = t^2 + t + 3$
 b $\frac{dx}{dt} = 3t - 1, \quad x = \frac{3}{2}t^2 - t + \frac{1}{2}$
 c $\frac{dx}{dt} = -2t + 8, \quad x = -t^2 + 8t - 15$
- 2 a $\frac{dy}{dx} = \frac{1}{y}, \quad y \neq 0$ b $\frac{dy}{dx} = \frac{1}{y^2}, \quad y \neq 0$
 c $\frac{dN}{dt} = \frac{k}{N^2}, \quad N \neq 0, k > 0$
 d $\frac{dx}{dt} = \frac{k}{x}, \quad x \neq 0, k > 0$
 e $\frac{dm}{dt} = km, \quad k < 0$ f $\frac{dy}{dx} = \frac{-x}{3y}, \quad y \neq 0$
- 3 a i $\frac{dP}{dt} = kP$ ii $t = \frac{1}{k} \ln P + c, \quad P > 0$
 b i 1269 ii $P = 1000(1.1)^{\frac{t}{2}}, \quad t \geq 0$

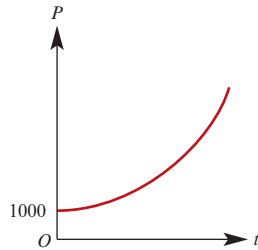

- 4 a i $\frac{dP}{dt} = k\sqrt{P}, \quad k < 0, P > 0$
 ii $t = \frac{2\sqrt{P}}{k} + c, \quad k < 0$
- b i 12 079
 ii

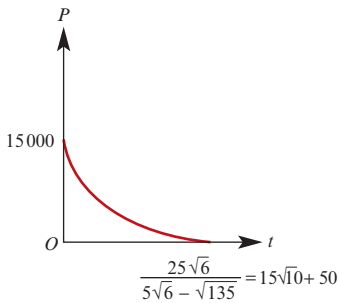

- 5 a i $\frac{dP}{dt} = \frac{k}{P}, \quad k > 0, P > 0$
 ii $t = \frac{1}{2k} P^2 + c$
- b i $P = 50\,000\sqrt{21t + 400}, \quad t \geq 0$
 ii

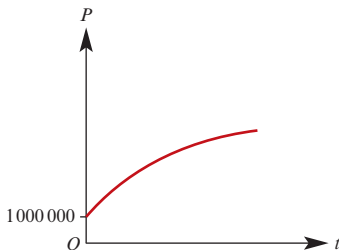

- 6 $y = 10e^{\frac{x}{10}}$
 7 $\frac{140^\circ}{3} \text{ C}$
 8 $\theta = 331.55 \text{ K}$
 9 23.22
- 11 a $x = \frac{1}{3}(20 - 14e^{-\frac{1}{10}t})$
 b 19 minutes
- 12 $y = 100 - 90e^{-\frac{x}{10}}$

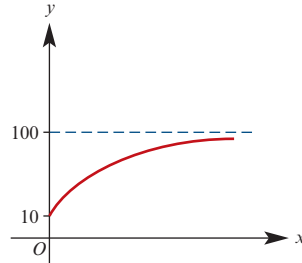

- 13 13 500
- 14 a 14 400 b 13 711 c 14 182
- 15 a $\frac{dV}{dt} = 0.3 - 0.2\sqrt{V}, \quad V > 0$
 b $\frac{dm}{dt} = 50 - \frac{6m}{100 - t}, \quad 0 \leq t < 100$
 c $\frac{dx}{dt} = \frac{-5x}{200 + t}, \quad t \geq 0$
- 16 a $\frac{dm}{dt} = \frac{1}{4}(1 - 4m)$
 b $\frac{1}{4}(1 - e^{-t})$

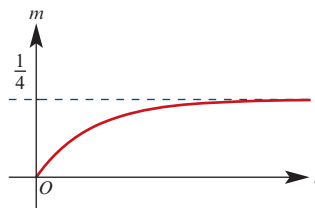

- c $\frac{1}{4}(1 - e^{-2}) \text{ kg}$
- 17 a $\frac{m}{100} \text{ kg/min}$
 b $\frac{dm}{dt} = \frac{-m}{100}$
 c $m = 20e^{-\frac{t}{100}}, \quad t \geq 0$
 d

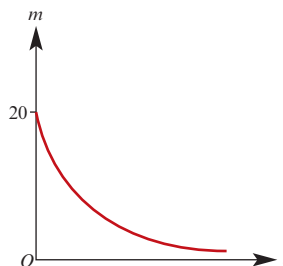

18 a 0.25 kg/min b $\frac{m}{100}$ kg/min

c $\frac{dm}{dt} = 0.25 - \frac{m}{100}$

d $m = 25(1 - e^{-\frac{t}{100}})$, $t \geq 0$

e 51 minutes

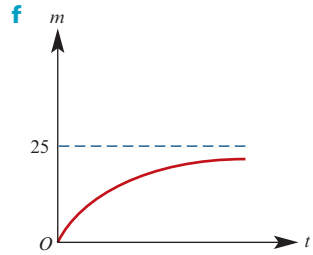

19 a $\frac{dx}{dt} = \frac{10-x}{50}$ b 11.16 minutes

20 a $\frac{dx}{dt} = \frac{80-x}{200}$, $x = 80 - 70e^{-\frac{t}{200}}$

b $\frac{dx}{dt} = 0.4 - \frac{x}{400+t}$

21 a $\frac{dx}{dt} = -\frac{x}{10}$ b $x = 10e^{-\frac{t}{10}}$

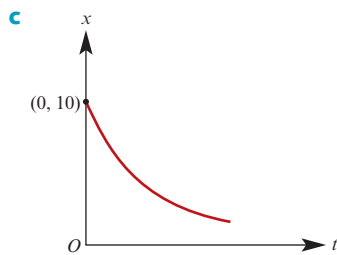

d $10 \ln 2 \approx 6.93$ mins

22 a $N = 50\,000(99e^{\frac{t}{10}} + 1)$, $t \geq 0$

b At the end of 2016

Exercise 13E

1 $P = \frac{2e^t}{2e^t - 1}$

2 a $P = \frac{500e^{0.02t}}{4 + e^{0.02t}}$

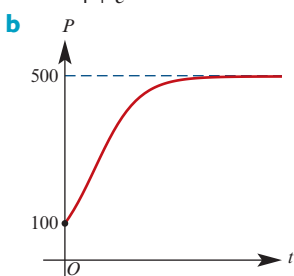

c 250

3 a $P'(t) = 0.3P\left(1 - \frac{P}{10\,000}\right)$

b $P(t) = \frac{10\,000e^{0.3t}}{3 + e^{0.3t}}$

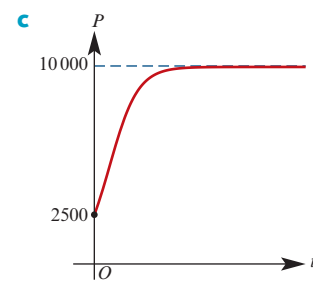

d 5990

e $\frac{10}{3} \ln 3 \approx 3.66$ years

4 12.5 wasps per month

5 $P = \frac{3000e^{0.05t}}{7 + 3e^{0.05t}}$

6 a 5 b 400 c $t = \frac{5}{4} \ln(79)$

d 80 cases per week e 60 cases per week

7 a $P = \frac{3000e^{0.1t}}{3e^{0.1t} - 1}$

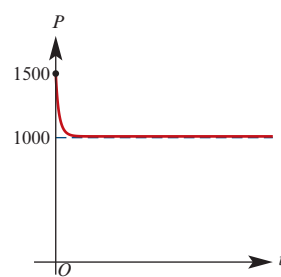

b $P = \frac{1000e^{0.1t}}{e^{0.1t} + 4}$

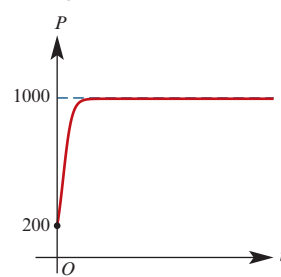

c $P = 1000$

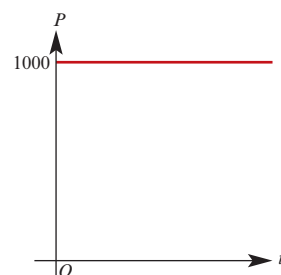

- 8 a $P = \frac{50\,000e^{0.1t}}{23 + 2e^{0.1t}}$
 b i 3419 ii 24 307
 c 24 months d 38 months
 e

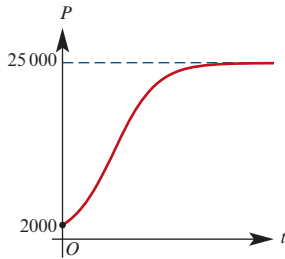

- 9 a $y = \frac{30 - 10e^{-0.1x}}{3 - 2e^{-0.1x}}, x \geq 0$
 b $y = \frac{30 + 10e^{-0.1x}}{3 + 2e^{-0.1x}}, x \geq 0$
 c $y = \frac{20 - 35e^{-0.1x}}{2 - 7e^{-0.1x}}, 0 \leq x \leq 10 \ln\left(\frac{7}{4}\right)$

Exercise 13F

- 1 a $y = Ae^{\frac{x^2}{2}}$ b $y^2 = x^2 + c$
 c $y = Ae^{\frac{x^3}{12}}$ d $y^2 = 2 \ln|x| + c$
 2 a $y^2 + x^2 = 2, y > 0$ or $y = \sqrt{2 - x^2}$
 b $y = x$
 c

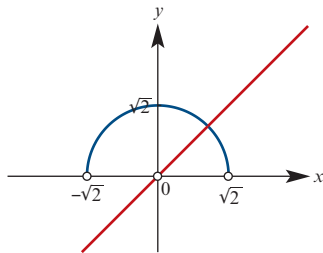

- 3 $y = \frac{1}{2}(x^2 + 1)^2$ 4 $y^2 - x^2 = 5$
 5 Circles centre (-1, 3) 6 $y^3 = c - \frac{3}{2x^2}$
 7 $y = \frac{-2x^2}{2Ax^2 - 2x + 3}$
 8 a $y = Ae^{e^x + x}$ b $y = Ae^{3x^3}$
 c $y^2 = -\frac{2}{\ln(x)} + c$
 9 a $y = \sqrt{\frac{2x^3}{3} + 2x + 1}$ b $\tan y = 2 - \frac{1}{x}$
 10 $\frac{y^3}{3} - \frac{y^2}{2} = \frac{x^3}{3} - \frac{x^2}{2} + c$
 11 b $x = A(t - 25)^2$ c $\frac{9}{25}$
 12 b $\frac{13}{25}e^{\frac{72}{5}}N_0$
 13 $y = 2xe^{\frac{x^2}{2}}$
 14 $y = \frac{-3}{\sin^3 x - 1} - 1$

Exercise 13G

- 1 a $\frac{dh}{dt} = \frac{-2000}{\pi h^2}, h > 0$
 b $\frac{dh}{dt} = \frac{1}{A}(Q - c\sqrt{h}), h > 0$
 c $\frac{dh}{dt} = \frac{3 - 2\sqrt{V}}{60\pi}, V > 0$
 d $\frac{dh}{dt} = \frac{-4\sqrt{h}}{9\pi}, h > 0$
 2 a $\frac{dy}{dt} = 5 \sin t$ b $y = -5 \cos t + c$
 3 a $t = -\frac{2\pi}{25}h^{\frac{5}{2}} + 250\pi$ b 13 hrs 5 mins
 4 a $\frac{dx}{dt} = -\frac{1}{480\sqrt{4-x}}$ b $t = 320(4-x)^{\frac{3}{2}}$
 c 42 hrs 40 mins
 5 a $\frac{dr}{dt} = -8\pi r^2$ b $r = \frac{2}{16\pi t + 1}$
 6 a $\frac{dh}{dt} = \frac{1000}{A}(Q - kh), h > 0$
 b $t = \frac{A}{1000k} \ln\left(\frac{Q - kh_0}{Q - kh}\right), Q > kh_0$
 c $\frac{A \ln 2}{1000k}$ minutes

Exercise 13H

- 1 a 1.7443 b 1.8309 c 4 d 3.2556

Exercise 13I

- 1 a $y_3 \approx 1.2975$ b $y_4 \approx 0.0388$
 c $y_3 \approx 1.3144$ d $y_3 \approx 0.0148$
 2 a i 1.8415 ii Euler 1.8438
 b i 0.5 ii Euler 0.5038
 c i 2.2190 ii Euler 2.2169
 d i 0.4055 ii Euler 0.4076
 3 a $\tan(1) + 2 \approx 3.5574$
 b i 3.444969502 ii 3.498989223
 iii 3.545369041
 4 2.205 5 30.69 6 1.547
 7 a b

z	Pr(Z ≤ z)	
	Euler	CAS
0	0.5	0.5
0.1	0.53989423	0.53983
0.2	0.57958948	0.57926
0.3	0.61869375	0.61791
0.4	0.65683253	0.65542
0.5	0.69365955	0.69146
0.6	0.72886608	0.72575
0.7	0.76218854	0.75804
0.8	0.79341393	0.78814
0.9	0.82238309	0.81594
1	0.84899161	0.84134

- c i 0.69169538 ii 0.84212759

Exercise 13J

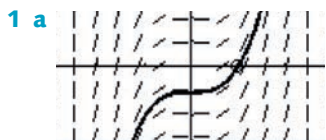

$y = x^3 - 1$



$y = 1 - \cos x$

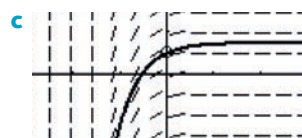

$y = \frac{1}{2}(3 - e^{-2x})$

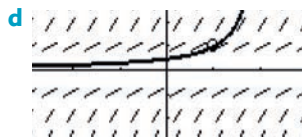

$y = \frac{1}{2-x}, x < 2$

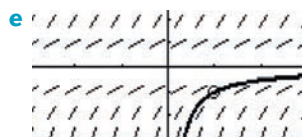

$y = -\frac{1}{x}, x > 0$

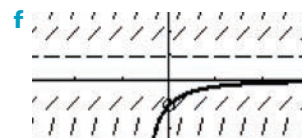

$y = \frac{1}{1 - 2e^x}, x > -\ln 2$

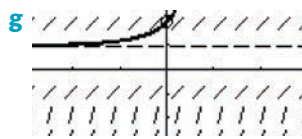

$y = \frac{2}{2 - e^x}, x < \ln 2$



$y = -\ln(\cos x), -\frac{\pi}{2} < x < \frac{\pi}{2}$

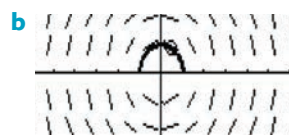
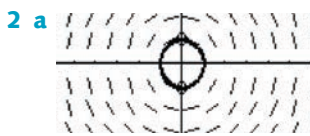

Chapter 13 review

Short-answer questions

1 a $y = x - \frac{1}{x} + c$ **b** $y = e^{10x+c}$

c $y = -\frac{1}{2}\left(\frac{\sin(3t)}{9} + \frac{\cos(2t)}{4}\right) + at + b$

d $y = \frac{e^{-3x}}{9} + e^{-x} + ax + b$

e $y = 3 - e^{-\frac{x}{2}+c}$ **f** $y = \frac{3x}{2} - \frac{1}{4}x^2 + c$

2 a $y = \frac{1}{2} \sin(2\pi x) - 1$ **b** $y = \frac{1}{2} \ln |\sin(2x)|$

c $y = \ln|x| + \frac{1}{2}x^2 - \frac{1}{2}$ **d** $y = \frac{1}{2} \ln(1 + x^2) + 1$

e $y = e^{-\frac{x}{2}}$ **f** $x = 64 + 4t - 5t^2$

3 a $k = 2, m = -2$

4 a $\frac{2}{\sqrt{3}} - 1$ **b** $\frac{8}{3}$

5 $n = -3, n = 5$

6 a $y = 3 \tan(3x + \arctan(\frac{4}{3})) - 4$ **b** 5

7 a 0.6826 **b** $y = \frac{3}{2} - \frac{1}{x}$ **c** $\frac{2}{3}$

8 b $y = 2 \tan(2x - \arctan(\frac{1}{2})) - 4$

9 a $k = \frac{1}{10} \ln(\frac{5}{4})$ **b** 78.67°C

10 $y = 43 - \frac{2(25 - x^2)^{\frac{3}{2}}}{3}$

11 $k = -1$ **12** $\frac{dx}{dt} = \frac{3}{\pi x(12 - x)}$

13 $\frac{dC}{dt} = \frac{8\pi}{C}$ **14** $100 \ln 2 \approx 69$ days

15 $\frac{dS}{dt} = -\frac{S}{25}, S = 3e^{-\frac{t}{25}}$

16 a $\theta = 30 - 20e^{-\frac{t}{20}}$ **b** 29°C **c** 14 mins

17 a $\frac{dA}{dt} = 0.02A$ **b** $0.5e^{0.2}$ ha **c** $89\frac{1}{2}$ h

18 $x = \frac{2L}{3}$; maximum deflection = $\frac{L^3}{216}$

19 $\frac{dh}{dt} = \frac{6 - 0.15\sqrt{h}}{\pi h^2}$

Multiple-choice questions

- 1** C **2** D **3** B **4** A **5** E **6** C
7 D **8** E **9** A **10** C **11** A **12** E
13 D **14** E **15** C **16** C

Extended-response questions

- 1 a i $\frac{dx}{dt} = -kx, k > 0$
 ii $x = 100e^{\frac{-t \ln 2}{5760}} = 100 \cdot 2^{\frac{-t}{5760}}, t \geq 0$
 b 6617 years

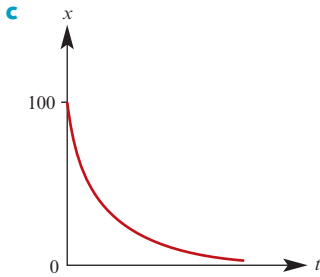

- 2 a $\frac{dx}{dt} = \frac{3k}{16}(8-x)(4-x)$
 b $t = \frac{1}{\ln(\frac{7}{6})} \ln\left(\frac{8-x}{8-2x}\right)$
 c 2 min 38 sec d $\frac{52}{31}$ kg

- 3 a $\frac{dT}{dt} = k(T - T_S), k < 0$
 b i 19.2 mins ii 42.2°C
 4 b $t = \frac{1}{k} \ln\left(\frac{kp - 1000}{5000k - 1000}\right), kp > 1000$
 c ii 0.22
 d $p = \frac{1}{k}(e^{kt}(5000k - 1000) + 1000)$

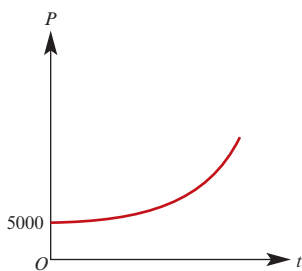

- 5 a $\frac{dN}{dt} = 100 - kN, k > 0$
 b $t = \frac{1}{k} \ln\left(\frac{100 - 1000k}{100 - kN}\right)$
 c 0.16
 d $N = \frac{1}{k}(100 - e^{-kt}(100 - 1000k))$

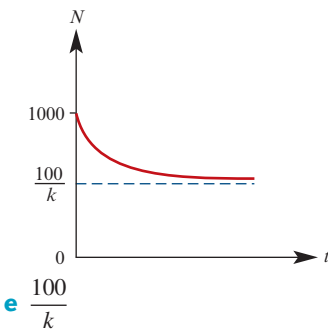

- 6 a $\frac{2L}{3}$ b $\frac{L}{60}$
 7 a $\frac{dT}{dt} = \frac{100 - T}{40}$ b $T = 100 - 80e^{\frac{-t}{40}}$
 c 62.2°C d

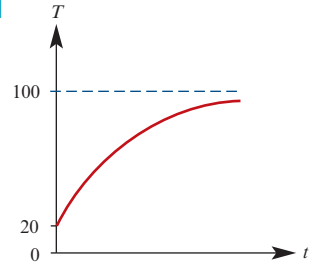

- 8 a i $t = 25 \ln\left(\frac{W}{350}\right), W > 0$
 ii $W = 350e^{\frac{t}{25}}$

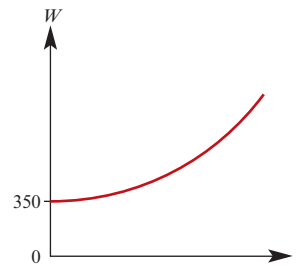

- iii 2586
 b 0
 c i $t = 25 \ln\left(\frac{9W}{7(800 - W)}\right), 0 < W < 800$

ii $W = \frac{5600e^{\frac{t}{25}}}{9 + 7e^{\frac{t}{25}}}$

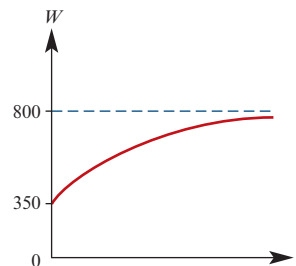

- iii 681
 9 a ii $x = \frac{R}{k}(1 - e^{-kt})$

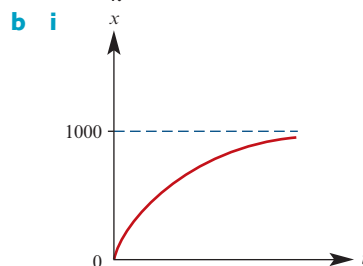

- ii 4.46 hours

- c i** 13.86 hours after drip is disconnected
ii $x = \begin{cases} 1000(1 - e^{-\frac{t}{20}}) & 0 \leq t \leq 20 \ln\left(\frac{5}{4}\right) \\ 250e^{-\frac{t}{20}} & t > 20 \ln\left(\frac{5}{4}\right) \end{cases}$

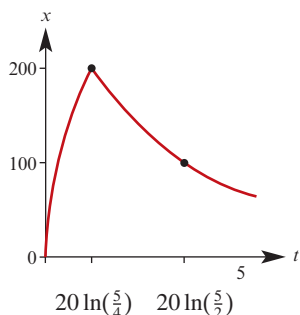

Chapter 14

Exercise 14A

- 1 a** $t = 0, x = 0; t = 1, x = 2; t = 2, x = 2;$
 $t = 3, x = 0; t = 4, x = -4$

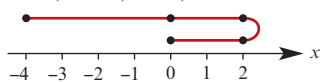

- b** -6 m **c** -1 m/s **d** $v = 3 - 2t$
e -2 m/s **f** $x = \frac{9}{4}, t = \frac{3}{2}$
g $\frac{17}{2}$ m **h** $\frac{17}{8}$ m/s

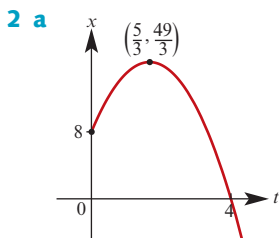

- b** $v = -6t + 10$

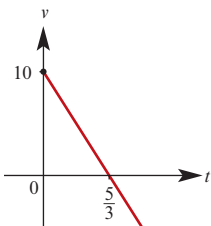

- c** $a = -6$

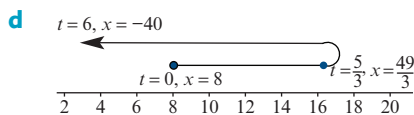
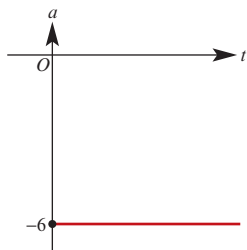

- e** -5 m

- f** $\frac{41}{3}$ m

- 3 a** 2, 4 **b** 12 m/s² **c** 10 m/s **d** 6 m/s

- 4 a** -3 m/s **b** 1, 3 **c** 12 m/s²

- 5** $0, \frac{4}{3}$

- 6 a** $\frac{25}{4}$ m/s **b** $\frac{56}{3}$ m

- 7 a** -30 m/s² **b** 4, 6 **c** 4 m **d** 120 m

- 8 a** 20 m/s **b** 32 m

- 9 a** 42 m/s **b** 6 s **c** 198 m

- 10 a i** $v = 9.8t$ **ii** $x = 4.9t^2$

- b** 19.6 m

- c** 19.6 m/s

- 11 a** $x = 2 \sin\left(\frac{t}{2}\right) + 0.5$

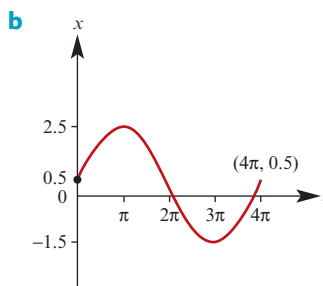

Object is stationary at $t = \pi, 3\pi$

- c** $a = -\frac{1}{2} \sin\left(\frac{t}{2}\right)$

- d i** $x = -4a + 0.5$

- ii** $(x - 0.5)^2 = 4 - 4v^2$

- iii** $v^2 = 1 - 4a^2$

- 12 a** 1 s and 15.5 m; 4 s and 2 m **b** -6.5 m/s

- c** -6 m/s **d** 9 m **e** 2 m

- 13 a** 9 m/s **b** 2π s

- 14 a** 585.6 m **b** 590.70 m

- 15** $x = \frac{1}{6}t - \frac{1}{4} \ln\left(\frac{2t+3}{3}\right)$

- 16** $\left(\frac{3\sqrt{3}}{2} - \frac{\pi}{3}\right)$ m

- 17 a** 0 m/s **b** $\frac{1}{2}$ m/s **c** $\frac{1}{2} \ln 2$ m

- d** $x = \frac{1}{2} \ln(1 + t^2)$ **e** $\ddot{x} = \frac{1 - t^2}{(1 + t^2)^2}$

- f** -0.1 m/s² **g** $-\frac{1}{8}$ m/s²

- 18** 5.25 s

- 19** 1.1 s

- 20** 18.14 m/s

Exercise 14B

- 1 3 m/s^2
 2 a $12\,960 \text{ km/h}^2$ b 1 m/s^2
 3 a 3 m/s^2 b $\frac{175}{2} \text{ m}$ c $\frac{10(\sqrt{7}-1)}{3}$ seconds
 4 -5 m/s^2
 5 a 12 m b 14 m/s c 2.5 s d 37 m
 6 a i 22.4 m ii 22.5 m
 b i 5 s ii -28 m/s
 7 a $\frac{10}{7} \text{ s}$ b 10 m c $\frac{20}{7} \text{ s}$
 8 a 200 s b 2 km
 9 a $\frac{10\sqrt{10}}{7} \text{ s}$ b $14\sqrt{10} \text{ m/s}$
 10 a 4.37 s b $-6\sqrt{30} \text{ m/s}$
 11 a 1.25 s b 62.5 cm
 12 a 0.23 b $5\frac{1}{3} \text{ s}$
 13 -0.64 m/s^2
 14 a 4 s b $\frac{1}{2} \text{ m/s}^2$

Exercise 14C

- 1 a 60 m b 20 m c 30 m d 55 m
 e 44 m f $\frac{70}{3} \text{ m}$ g $\frac{165}{2} \text{ m}$ h $\frac{49}{2} \text{ m}$
 2 a $v = -\frac{1}{2}t + 5$; $a = -\frac{1}{2}$; $x = -\frac{t^2}{4} + 5t$
 b $v = -\frac{2}{5}t^2 + 10$; $a = -\frac{4}{5}t$; $x = -\frac{2}{15}t^3 + 10t$
 c $v = 2t - 10$; $a = 2$; $x = t^2 - 10t$
 d $v = 6(t-1)(t-5)$; $a = 12(t-3)$;
 $x = 2(t^3 - 9t^2 + 15t)$
 e $v = 10 \sin\left(\frac{\pi}{10}t\right) + 10$; $a = \pi \cos\left(\frac{\pi}{10}t\right)$;
 $x = 10\left(t + \frac{10}{\pi} - \frac{10}{\pi} \cos\left(\frac{\pi}{10}t\right)\right)$
 f $v = 10e^{2t}$; $a = 20e^{2t}$; $x = 5e^{2t} - 5$
 3 3589.89 m

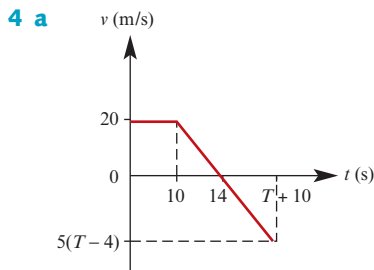

b 23.80 s

5 189 m

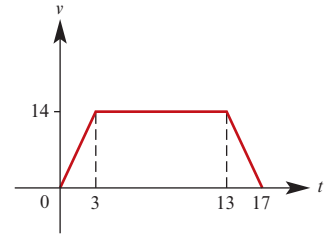

6 $a = \frac{25}{288}$, $\dot{x}_{\text{max}} = 8\frac{1}{3} \text{ m/s}$

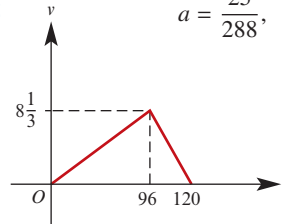

- 7 $68\frac{1}{3} \text{ s}$
 8 10 s , 150 m
 9 $10(3 + \sqrt{3}) \text{ s}$, $200(2 + \sqrt{3}) \text{ m}$
 10 a 2 s b $7\frac{1}{3} \text{ m}$
 11 36 s
 12 a 3600 m , 80 km/h
 b 90 s after A passed B, 200 m
 13 a $\dot{y} = k(1 - e^{-t})$

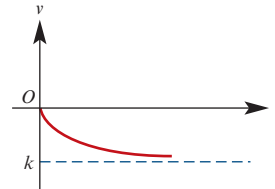

b Limiting velocity of $k \text{ m/s}$

Exercise 14D

- 1 a 7 m b 4 m
 2 a $x = \frac{1}{2} \ln(2e^{2t} - 1)$ b $-\frac{100}{2401} \text{ m/s}^2$
 3 a $v = 3(e^t - 1)$ b $a = 3e^t$
 c $x = 3(e^t - t - 1)$
 4 a $v = \frac{g}{k}(1 - e^{-kt})$ b $\frac{g}{k}$
 5 a $v = \tan\left(\frac{\pi}{3} - \frac{3t}{10}\right)$
 b $x = \frac{10}{3} \ln\left(2 \cos\left(\frac{\pi}{3} - \frac{3t}{10}\right)\right)$
 6 $v = 450\left(1 - e^{-\frac{t}{50}}\right)$
 7 $v = 15 \cos\left(\cos^{-1}\left(\frac{4}{5}\right) + \frac{2t}{5}\right)$
 8 a $x = 5e^{\frac{2t}{5}}$ b 273 m
 9 a $t = 50 \ln\left(\frac{500}{500 - v}\right)$ b $v = 500\left(1 - e^{-\frac{t}{50}}\right)$
 10 $\frac{1}{k} \ln 2$

11 $v = 8e^{-\frac{t}{5}}$; 3.59 m/s

12 **a** $v = \frac{90}{2t+3}$ **b** 91.66 m

Exercise 14E

1 -2 m/s^2

2 **a** $v = \pm 4$ **b** $t = -\ln 2$

c $x = 2(1 - \ln 2)$

3 **a** $v = \frac{1}{x+1}$

b **i** $x = e^t - 1$ **ii** $a = e^t$ **iii** $a = v$

4 $x = \frac{-5}{2} \ln\left(\frac{g+0.2v^2}{g+2000}\right)$; $x_{\max} = \frac{5}{2} \ln\left(\frac{g+2000}{g}\right)$

5 **a** $x = \cos(2t)$ **b** $a = -4x$

6 **a** $v = \ln(1+t)$ **b** $v^2 = 2 \ln(1+x)$

c $v = \sqrt{2t+1} - 1$

7 $v^2 = \frac{x}{2+x}$

8 **a** 4 **b** $2 \ln 2 - 1$

9 **a** 9.83 m **b** 1.01 s

Exercise 14F

1 **a** 0.5 m **b** 1 s **c** $\pi \text{ m/s}$

d $2\pi^2 \text{ m/s}^2$

2 **a** $T = \frac{2\pi}{5}$; $A = 4$

b $x = 4 \cos(5t)$, $\dot{x} = -20 \sin(5t)$,
 $\ddot{x} = -100 \cos(5t)$

3 **a** $\frac{2}{3\pi} \text{ m/s}$ **b** $\frac{1}{45\pi^2} \text{ m}$ **c** $\frac{4}{3\pi^2} \text{ m/s}$

4 0.347 m; 5.9186 m/s

5 16 m

6 $x = 2 \sin(2t + \epsilon)$, where the initial position is $x = 2 \sin \epsilon$

7 **a** 0.2 m **b** 0.5 s

8 $\frac{\pi}{20} \text{ m/s}^2$

9 96 cm/s

10 **a** 2 cm **b** 12 s **c** $\frac{\pi}{3} \text{ cm/s}$

d $\frac{\pi^2}{18} \text{ cm/s}^2$

11 Four times: $t = 4.18, 13.82, 40.18, 49.82$

12 **a** $\frac{2\pi}{3} \text{ s}$ **b** 15 m/s **c** $\dot{x} = -15 \sin(3t)$

d $x = 5 \cos(3t)$

13 **a** $\dot{x} = -\frac{5\pi}{6} \sin\left(\frac{\pi t}{12}\right)$ **b** $\ddot{x} = -\frac{5\pi^2}{72} \cos\left(\frac{\pi t}{12}\right)$

c 24 s **d** $\frac{5\pi}{6} \text{ cm/s}$ **e** $\frac{5\pi^2}{72} \text{ cm/s}^2$

14 **a** **i** $t = 2.5$ **ii** $t = 0, t = 5$

iii None **iv** $t = \frac{5}{6}, t = \frac{25}{6}$

b $t = 0, t = 5$

c **i** $t = \frac{5}{3}$ **ii** $t = \frac{10}{3}, t = \frac{20}{3}$

15 **a** $x = 5 \cos(3t)$ **b** $x = \frac{10}{3} \sin(3t)$

c $x = \frac{5\sqrt{10}}{3} \sin(3t + \epsilon)$, where $\tan \epsilon = 3$

16 **a** $v^2 = 2\left(\frac{81}{4} - \left(x + \frac{3}{2}\right)^2\right)$; $\ddot{x} = -2\left(x + \frac{3}{2}\right)$

b **i** $\pi\sqrt{2}$ **ii** $\frac{9}{2}$ **iii** $\frac{9\sqrt{2}}{2}$

17 **a** $\dot{x} = -\frac{5\pi}{4} \sin\left(\frac{\pi}{4}t + \frac{\pi}{3}\right)$;

$\ddot{x} = -\frac{5\pi^2}{16} \cos\left(\frac{\pi}{4}t + \frac{\pi}{3}\right)$

b $\dot{x}^2 = \frac{\pi^2}{16}(25 - x^2)$; $\dot{x} = -\frac{\pi^2 x}{16}$

c **i** 8 s **ii** 5 cm **iii** $\frac{5\pi}{8}\sqrt{3} \text{ cm/s}$

iv $-\frac{5\pi^2}{32} \text{ cm/s}^2$

18 **a** $x = 3 - 2 \cos(2t)$; $\ddot{x} = 8 \cos(2t) = -4(x - 3)$

b **i** 3 **ii** 2 **iii** π

19 **a** $x = 1 + \sqrt{2} \sin\left(3t - \frac{\pi}{4}\right)$

b $T = \frac{2\pi}{3}$; $A = \sqrt{2}$

20 **a** $\ddot{x} = -32(x - 1)$

b **i** $x = 1$ **ii** 2 **iii** $\frac{\pi\sqrt{2}}{4}$

Chapter 14 review

Short-answer questions

1 **a** After 3.5 seconds

b 2 m/s^2

c 14.5 m

d When $t = 2.5$ s and the particle is 1.25 m to the left of O

2 $x = 215\frac{1}{3}$, $v = 73$

3 **a** 57.6 km/h

b After 1 minute $6\frac{2}{3}$ seconds **c** 0.24

4 **a** $\frac{25\,000}{3} \text{ m/s}^2$

b 0.4125 m

c 10 000 m/s^2

d 0.5 m

e 37 500 m/s^2

f 0.075 m

5 **a** 44 m/s **b** $v = 55 - 11t \text{ m/s}$ **c** 44 m/s

d 5 s **e** 247.5 m

6 16 m

7 **a** 2 s **b** $v = \frac{-t}{\sqrt{9-t^2}}$, $a = \frac{-9}{(9-t^2)^{\frac{3}{2}}}$

c 3 m **d** $t = 0$

8 **a** 20 m/s **b** 32 m

9 **a** $x = 20$ **b** $\frac{109}{8} \text{ m/s}$

10 **a** **i** $v = 35 - 3g$ up **ii** $v = 5g - 35$ down

b $\frac{35^2}{g} \text{ m}$

c -35 m/s

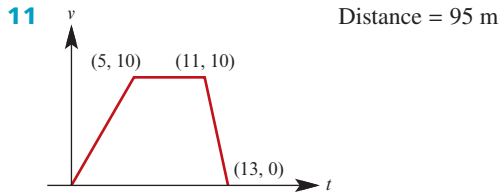

12 a $80 + 0.4g$ m/s **b** $\frac{80 + 0.4g}{g}$ s
c $\frac{(80 + 0.4g)^2}{2g}$ m **d** $\frac{2(80 - 0.4g)}{g}$ s

13 a $v^2 = 16(9 - (x + 1)^2)$; $\ddot{x} = -16(x + 1)$
b i $\pi\sqrt{2}$ **ii** $\frac{9}{2}$ **iii** $\frac{9\sqrt{2}}{2}$

Multiple-choice questions

- 1** A **2** C **3** A **4** D **5** B **6** E
7 C **8** C **9** C **10** A **11** E

Extended-response questions

1 a 10 m/s²
b $v = 50(1 - e^{-\frac{t}{5}})$
c i v (m/s) **ii** 14.98

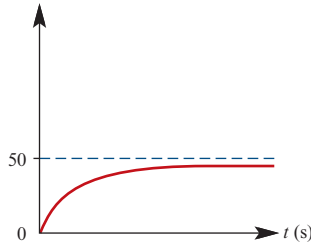

d i $x = 50(t + 5e^{-\frac{t}{5}} - 5)$ **ii** x (m) **iii** 1.32 s

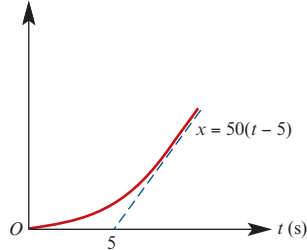

2 a i v (m/s) $1 + \ln 2$ $e^{-0.5}$ t (s)

ii 1.27 m **iii** 1.47 m
b $B = 10, A = 4.70$
3 a 30 minutes
b i $a = -k(\sin(\pi t) + \pi t \cos(\pi t) - 1)$
ii From 0 h to 0.18 h
c 845

4 a i $v = 4 - 10t - 3t^2$ **ii** $a = -10 - 6t$
iii 0.36 **iv** $t = 0$ or $t = 0.70$
v $t = 2.92$

b i $x = t^2 - t^3 + 2t$ **ii** $\frac{7}{3}$ s **iii** Yes

5 a i $v = -\frac{5\pi}{4} \sin\left(\frac{\pi}{4}t + \frac{\pi}{3}\right)$
ii $a = -\frac{5\pi^2}{16} \cos\left(\frac{\pi}{4}t + \frac{\pi}{3}\right)$

b i $v = \pm \frac{\pi}{4} \sqrt{25 - x^2}$ **ii** $a = -\frac{\pi^2 x}{16}$

c 3.4 cm/s
d -1.54 cm/s²

e i 5 cm **ii** $\frac{5\pi}{4}$ cm/s **iii** $\frac{5\pi^2}{16}$ cm/s²

6 0 m

7 a $v = \frac{300(1 - 4510t)}{12\,300t + 1}, 0 \leq t \leq \frac{1}{4510}$

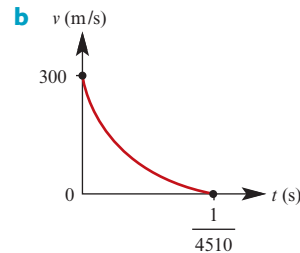

c i $x = -110t + \frac{1}{30} \ln(12\,300t + 1)$
ii $x = \frac{1}{30} \left(\ln\left(\frac{410}{v + 110}\right) - \frac{110}{v + 110} + \frac{11}{41} \right)$

iii 19 mm
d i $t = \frac{\sqrt{110}}{33\,000} \times \left(\tan^{-1}\left(\frac{3\sqrt{110}}{11}\right) - \tan^{-1}\left(\frac{v\sqrt{110}}{1100}\right) \right)$

ii $v = 10\sqrt{110} \times \tan\left(\tan^{-1}\left(\frac{3\sqrt{110}}{11}\right) - 300\sqrt{110}t\right)$,

for $0 \leq t \leq \frac{\sqrt{110} \tan^{-1}\left(\frac{3\sqrt{110}}{11}\right)}{33\,000}$

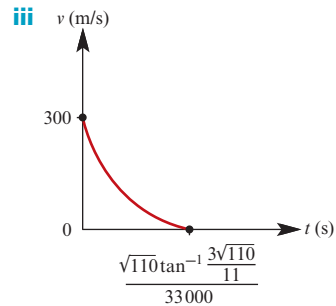

iv 20 mm

8 a 30.05 m/s

b i $\frac{dv}{dt} = \frac{-3}{10} \left(3t^2 - 42t + \frac{364}{3} \right), 4 \leq t \leq 10$

ii $t = 7$ (Chasing for 3 s)

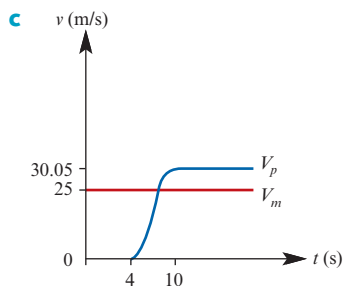

d i 90.3 m

ii $x_p = -\frac{3}{40}t^4 + \frac{21}{10}t^3 - \frac{91}{5}t^2 - \frac{1281}{20}t - \frac{401}{5}$,
for $t \in [4, 10]$

e 41.62 s

9 a V (km/h)

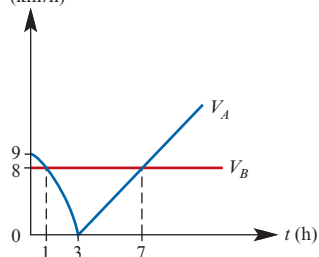

b $t = 1$ or $t = 7$

c i 11.7 h ii 1.7 h

10 a i $t = 1$ or $t = 5$

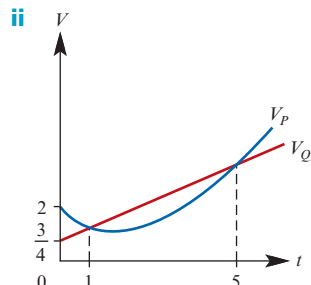

b i 2.2

ii $0 < t < 2.2, t > 6.8$

11 a i 4.85 m/s

ii 0.49 s

b i $v = 9.8t - \frac{1}{2}t^2$

ii $x = 4.9t^2 - \frac{1}{6}t^3$

iii 0.50 s

c i $x = 1.2 - 2.45t^2$

ii 6 cm

12 a 3 s

b $v = \begin{cases} 2t, & 0 \leq t \leq 3 \\ 6, & 3 < t \leq 13 \\ 8e^{13-t} - 2, & 13 < t \leq 13 + \ln 4 \end{cases}$

c 14.4 s

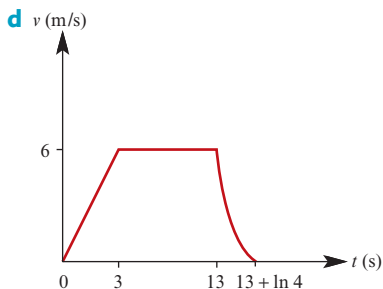

e 72.2 m

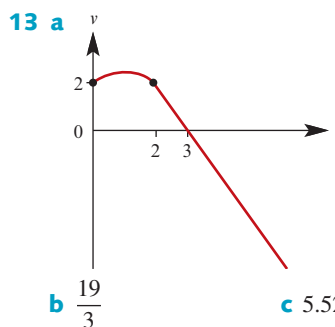

Chapter 15

Short-answer questions

1 a 6π b $6\pi^2$

2 a $\frac{1}{3}, -\frac{7}{3}$ b $3x - 7y = -11$

3 Asymptotes $y = -\frac{x}{3}, x = 0$;

Axis intercept $(\sqrt[3]{4}, 0)$; Stat point $(-2, 1)$

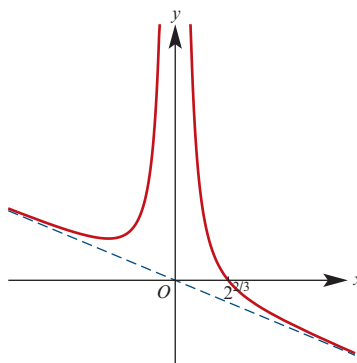

4 a $-1 + \frac{5}{4(x+2)} - \frac{5}{4(x-2)}$

b $\frac{5 \ln 3 - 4}{2}$

5 $y = -\frac{1}{2} \ln(\cos(2x))$

6 $y = 2(1 + x^2)$

7 $\left[-1, -\frac{\sqrt{2}}{2}\right] \cup \left[\frac{\sqrt{2}}{2}, 1\right]$

8 Asymptote $y = 4$; Stat point $(0, 5)$

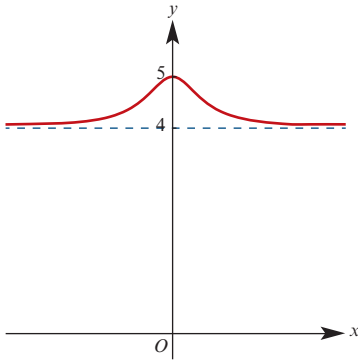

9 $\frac{dy}{dx} = -\tan t, -1$

10 a $\frac{1}{2}(\sin(e^2) - \sin(1))$ b $\frac{4}{15}$ c $\ln\left(\frac{27}{32}\right)$

11 1.27 12 $8\pi a^5$

13 $\frac{1}{2}\ln(1 + u^2)$ 14 $\frac{5g}{2}, \frac{2}{5}$

15 $10\,000\ln\left(\frac{5}{6}\right) + 2000$

16 b $(0, 0), \left(\sqrt{3}, \frac{\sqrt{3}}{2}\right), \left(-\sqrt{3}, -\frac{\sqrt{3}}{2}\right)$

17 a $-\frac{1}{2}(2x + 1)e^{-2x}$

b $\frac{1}{9}\sin(3x) - \frac{1}{3}x\cos(3x)$

c $x\arccos(2x) - \frac{1}{2}\sqrt{1 - 4x^2}$

d $\frac{1}{4}x^4(4\ln(3x) - 1)$

18 a $-4 + 2\sqrt{2} + \frac{\pi}{\sqrt{2}}$ b $\frac{1}{4}e^2(5e^4 - 1)$

c $\ln 2 - 1$

19 a $\ddot{x} = -a\omega^2\cos(\omega t) - b\omega^2\sin(\omega t) = -\omega^2x$

b i π s ii 5 m iii 10 m/s

Multiple-choice questions

- 1 C 2 D 3 D 4 B 5 B
- 6 A 7 C 8 C 9 D 10 A
- 11 E 12 C 13 B 14 C 15 E
- 16 B 17 A 18 A 19 B 20 E
- 21 A 22 D 23 A 24 A 25 D
- 26 B 27 B 28 C 29 C 30 D
- 31 B 32 E 33 D 34 B 35 B
- 36 E 37 B 38 E 39 E 40 E
- 41 A 42 C 43 C 44 B 45 A
- 46 D 47 C 48 C 49 E 50 A
- 51 B 52 A 53 A 54 E 55 D
- 56 E 57 A 58 C 59 A 60 C
- 61 C 62 C 63 B 64 C 65 D
- 66 A 67 B 68 C 69 A 70 A
- 71 A 72 D 73 C 74 D 75 C
- 76 A 77 B 78 A 79 D 80 C

Extended-response questions

1 a 1250 π

b ii $\frac{10\pi}{3}$ iii $h = -\frac{5t}{6} + 25$

iv $V = 2\pi\left(25 - \frac{5t}{6}\right)^2$

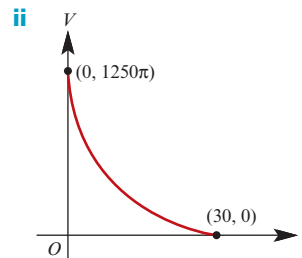
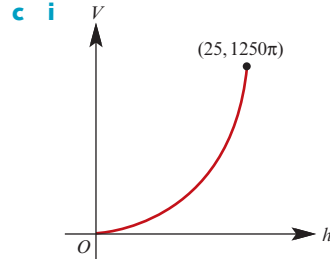

2 a

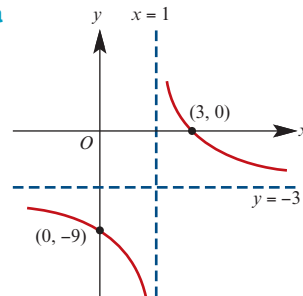

b $(2, 3), (3, 0)$ c $4.5 - \ln 64$

d $y = -3x + 6\sqrt{2}, y = -3x - 6\sqrt{2}$

3 a 1180 b 129 000

4 e i $\frac{dv}{dh} = \pi\left(\frac{25h}{3} + 100\right)$

ii $\frac{dh}{dt} = \frac{-9\sqrt{h}}{625\pi^2(h + 12)^2}$

f 65 days 19 hours

5 a ii 6.355 cm

d 15.7

e i $\frac{dV}{dt} = \frac{-3\pi a^2}{2T}h$

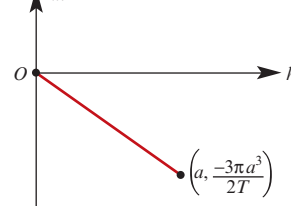

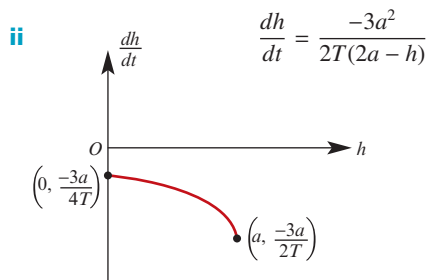

f i $-\frac{a}{T}$ **ii** $-\frac{6a}{7T}$

g -0.37

6 a $\frac{-2ax - b}{(ax^2 + bx + c)^2}$

b $(-\frac{b}{2a}, \frac{4a}{4ac - b^2})$

i Maximum

ii Minimum

c i

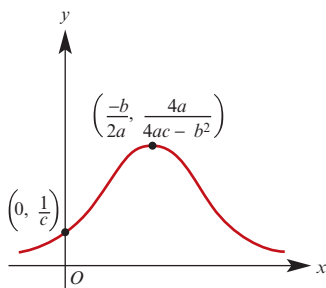

$y = 0$ is only asymptote

ii

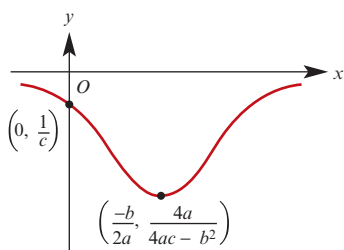

$y = 0$ is only asymptote

d i

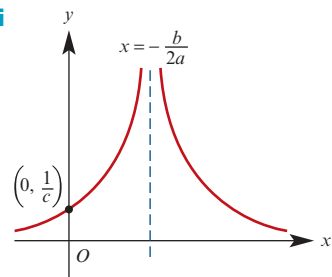

Asymptote at $y = 0$

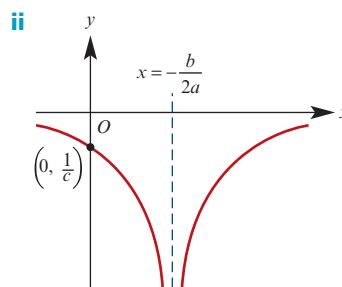

Asymptote at $y = 0$

e

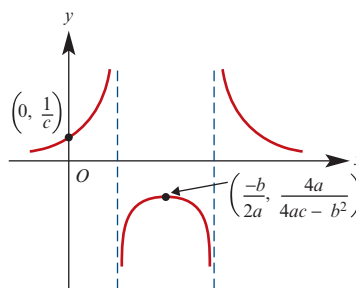

Asymptotes at $y = 0$, $x = \frac{-b \pm \sqrt{b^2 - 4ac}}{2a}$

7 a $\frac{dy}{dx} = 2ax - \frac{2b}{x^3}$

b $(\frac{\sqrt[4]{a^3b}}{a}, 2\sqrt{ab})$ and $(-\frac{\sqrt[4]{a^3b}}{a}, 2\sqrt{ab})$;

Both are minimum if $a > 0$, $b > 0$

8 a $e^{-\frac{5}{6}} \approx 0.435$ **b** $e^{-\frac{5}{6}} \approx 0.435$

9 a $\frac{1}{5}$

10 b $\frac{9}{25}$ **c** $\frac{1}{9(\frac{2}{3})^t + 1}$ **d** $t > 5.419$

e

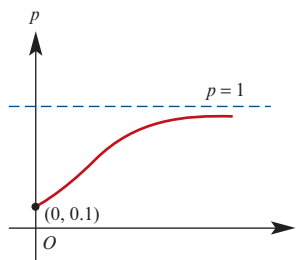

11 b $\frac{\sqrt[3]{k^2p}}{k}$

12 a $\theta = \tan^{-1}(\frac{8}{x}) - \tan^{-1}(\frac{2}{x})$, $x > 0$

b $\frac{d\theta}{dx} = \frac{-8}{x^2 + 64} + \frac{2}{x^2 + 4}$

c $0 < \theta \leq \tan^{-1}(\frac{3}{4})$

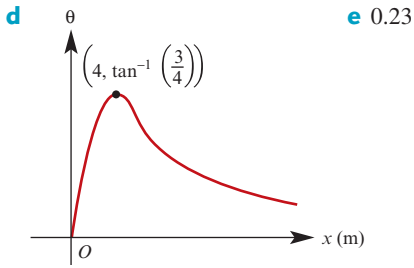

13 a 8 m **b** π s **c** $\frac{\pi}{6}$ s

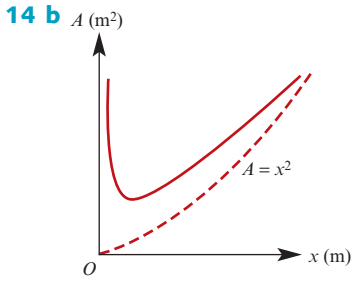

c $x = 6.51$ or $x = 46.43$ **d** 20

15 288 cm^2

16 a $y = \frac{2}{5}x^2$

b $V = 40\sqrt{10}y^{\frac{3}{2}}$

c 252 mm

d $\frac{dy}{dt} = \frac{\sqrt{10y}}{10y}$, $t = \frac{2\sqrt{10}}{3}y^{\frac{3}{2}}$

e i 3 min 9 s **ii** 5 min 45 s

17 a $v_A = \frac{20}{\sqrt{2t+1}}$, $v_B = \frac{100}{t+10}$

b $x_A = 20(\sqrt{2t+1} - 1)$, $x_B = 100 \ln\left(\frac{t+10}{10}\right)$

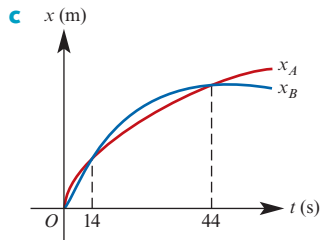

d 14 s and 44 s

18 a $v = 50 - 50e^{-\frac{t}{5}}$

b 49.9963

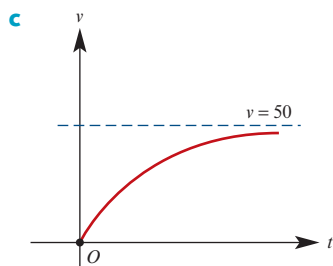

d i $x = 50(t + 5e^{-\frac{t}{5}} - 5)$ **ii** 125.2986 m

19 a $y = \frac{Ne^{2t}}{3 + e^{2t}}$, $\frac{dy}{dt} = \frac{6Ne^{2t}}{(3 + e^{2t})^2}$ **b** N

c $\frac{dy}{dt} > 0$ for all t **d** $\frac{N}{2}$

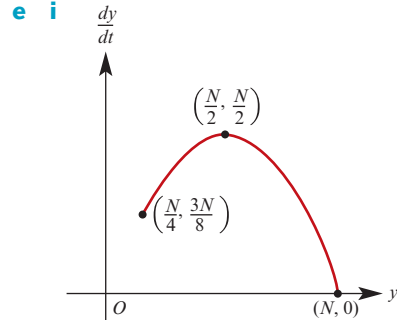

ii At $t = \frac{1}{2} \ln 3 \approx 0.549306$

20 a i $v^2 = \frac{2gR^2}{x} + u^2 - 2gR$

ii $x = \frac{2gR^2}{2gR - u^2}$ **iii** $u \geq \sqrt{2gR}$

b 40 320 km/h

21 a 0 **b** 1 **c** -1 **d** $\frac{4}{(e^x + e^{-x})^2}$

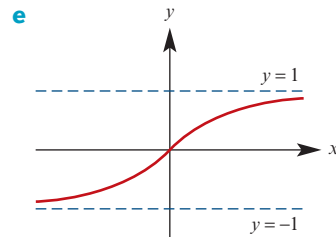

f $f^{-1}(x) = \frac{1}{2} \ln\left(\frac{1+x}{1-x}\right)$, $-1 < x < 1$

g $\frac{1}{1-x^2}$

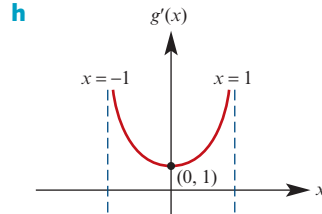

22 a i $y = 2r \sin\left(\frac{1}{2}\theta\right)$ **ii** $\cos \theta = \frac{r}{r+h}$

b i $\frac{dy}{d\theta} = r \cos\left(\frac{1}{2}\theta\right)$;

$\frac{dy}{dt} = \frac{r \cos\left(\frac{1}{2}\theta\right) \cos^2 \theta \sin t}{\sin \theta}$

ii 6000 km **iii** 1500 km/h

24 a $V = \frac{4}{3}\pi r^3$ **b** $4\pi r^2 \frac{dr}{dt} = -t^2$

c $r = \sqrt[3]{\frac{4000\pi - t^3}{4\pi}}$ **d** 23.2 mins

Chapter 16

Exercise 16A

- 1 a $y = 2x$; dom = \mathbb{R} ; ran = \mathbb{R}
 b $x = 2$; dom = $\{2\}$; ran = \mathbb{R}
 c $y = 7$; dom = \mathbb{R} ; ran = $\{7\}$
 d $y = 9 - x$; dom = \mathbb{R} ; ran = \mathbb{R}
 e $x = \frac{1}{9}(2 - y)^2$; dom = $[0, \infty)$; ran = \mathbb{R}
 f $y = (x + 3)^3 + 1$; dom = \mathbb{R} ; ran = \mathbb{R}
 g $y = 3^{\left(\frac{x-1}{2}\right)}$; dom = \mathbb{R} ; ran = $(0, \infty)$
 h $y = \cos(2x + \pi) = -\cos(2x)$;
 dom = \mathbb{R} ; ran = $[-1, 1]$
 i $y = \left(\frac{1}{x} - 4\right)^2 + 1$;
 dom = $\mathbb{R} \setminus \{0\}$; ran = $[1, \infty)$
 j $y = \frac{x}{1+x}$;
 dom = $\mathbb{R} \setminus \{-1, 0\}$; ran = $\mathbb{R} \setminus \{0, 1\}$
- 2 a $\frac{x^2}{4} + \frac{y^2}{9} = 1$; dom = $[-2, 2]$; ran = $[-3, 3]$

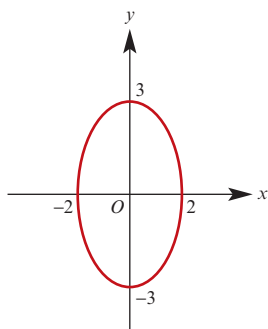

- b $3x + 2y = 6$; dom = $[0, 2]$; ran = $[0, 3]$

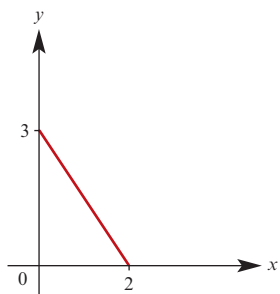

- c $y = 3x^2$; dom = $\mathbb{R}^+ \cup \{0\}$; ran = $\mathbb{R}^+ \cup \{0\}$

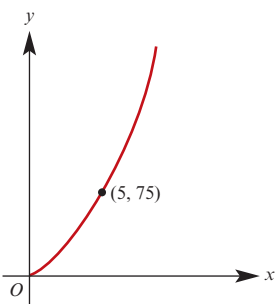

- d $y = 3x^{\frac{2}{3}}$; dom = $\mathbb{R}^+ \cup \{0\}$; ran = $\mathbb{R}^+ \cup \{0\}$

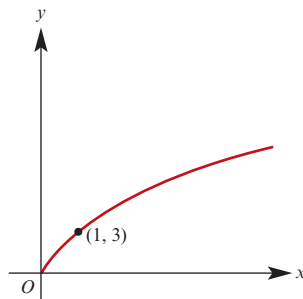

- e $x^2 + y^2 = 1$; dom = $[0, 1]$; ran = $[0, 1]$

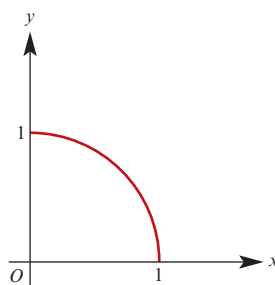

- f $\frac{x^2}{9} - \frac{y^2}{4} = 1$; dom = $(3, \infty)$; ran = $(0, \infty)$

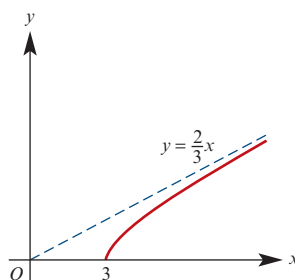

- g $x^2 + y^2 = 16$; dom = $[-4, 4]$; ran = $[0, 4]$

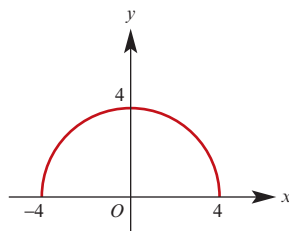

- h $3y = 2x - 6$; dom = $[3, \infty)$; ran = $[0, \infty)$

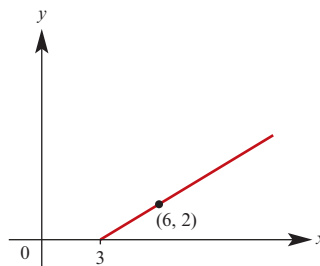

i $y = 5x^2 - 36x + 63$;
 $\text{dom} = \mathbb{R}$; $\text{ran} = [-\frac{9}{5}, \infty)$

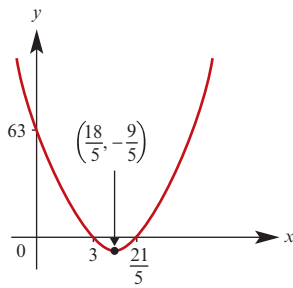

- 3 a** $r(t) = ti + (3 - 2t)j$, $t \in \mathbb{R}$
b $r(t) = 2 \cos t i + 2 \sin t j$, $t \in \mathbb{R}$
c $r(t) = (2 \cos t + 1)i + 2 \sin t j$, $t \in \mathbb{R}$
d $r(t) = 2 \sec t i + 2 \tan t j$, $t \in (-\frac{\pi}{2}, \frac{\pi}{2})$
e $r(t) = ti + ((t - 3)^2 + 2(t - 3))j$, $t \in \mathbb{R}$
f $r(t) = \sqrt{6} \cos t i + 2 \sin t j$, $t \in \mathbb{R}$
- 4 a** $r(\theta) = (2 + 5 \cos \theta)i + (6 + 5 \sin \theta)j$
b $(x - 2)^2 + (y - 6)^2 = 25$

Exercise 16B

1 a $x^2 + y^2 = 1$
b

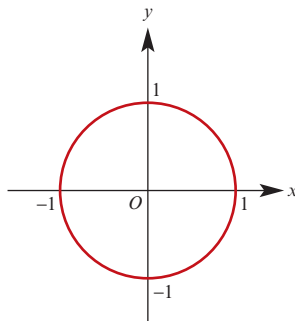

c $\frac{\pi}{2}, \frac{3\pi}{2}, \frac{5\pi}{2}, \dots$ i.e. $\frac{(2n-1)\pi}{2}$, $n \in \mathbb{N}$

2 a i $x = \frac{y^2}{64} - 9$

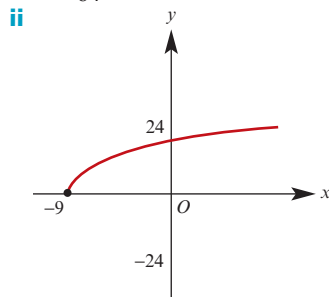

iii 3

b i $y = \frac{1}{1+x}$, $x > -1$

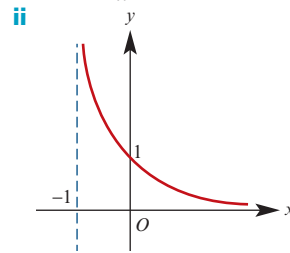

iii $t = -1$

c i $y = 1 - x$, $x < 1$

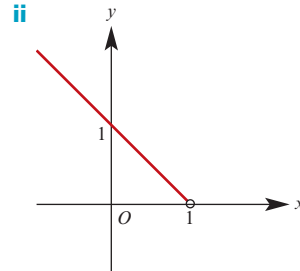

iii $t = 1$

3 a Position vector $i + 4j$; Coordinates (1, 4)

b (1, 4) and (7, -8) **c** $\sqrt{65}$

4 a $\frac{9}{2}i - \frac{3}{2}j$, $(\frac{9}{2}, -\frac{3}{2})$

b (6, -1) and $(\frac{9}{2}, \frac{-3}{2})$

c $5\sqrt{2}$

5 a $\sqrt{137}$ **b** $t = \frac{-2}{5}$ and $t = -1$

6 a $3i + 6j - 3k$

b $3\sqrt{6}$

c $4i + 8j - 3k$

d $i + 2j$

7 a $3i + j + 4k$

b $\sqrt{14}$

8 a $\frac{2}{3}$, $b = 7$

9 a $\frac{x^2}{9} + \frac{y^2}{4} = 1$

b $3i$

c i 303.69° **ii** 285.44°

10 a $y = \frac{1}{x}$, for $x \geq 1$ **b** $i + j$

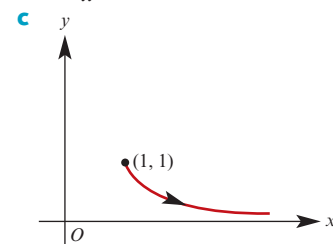

11 a $r(0) = 2i$

b $\frac{5}{2}i + \frac{3}{2}j$

c $x^2 - y^2 = 4$

12 a $r(0) = \mathbf{0}$, $r(20\sqrt{3}) = 2000\sqrt{3}\mathbf{i}$

b $y = \sqrt{3}x - \frac{x^2}{2000}$, $0 \leq x \leq 2000\sqrt{3}$

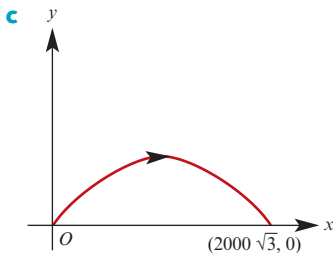

13 Collide when $t = \frac{3}{2}$; $r(\frac{3}{2}) = \frac{27}{2}\mathbf{i} - \frac{81}{4}\mathbf{j}$

14 Particle is moving along a circular path, with centre $(0, 0, 1)$ and radius 3, starting at $(3, 0, 1)$ and moving anticlockwise; always a distance of 1 above the x - y plane. It takes 2π units of time to complete one circle.

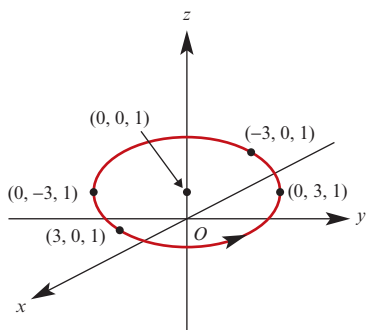

15 Particle is moving along a straight line, starting at $(0, 0, 0)$, and moving 'forward 1', 'across 3' and 'up 1' at each step.

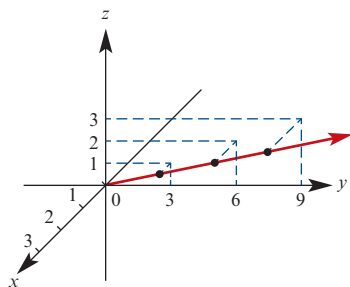

16 a $\frac{(x-1)^2}{4} + \frac{(y-3)^2}{25} = 1$

b i $(-1, 3)$ **ii** $(1, -2)$ **iii** $(3, 3)$

c π units of time

d Anticlockwise

17 a i $y = 2x$, $0 \leq x \leq 1$

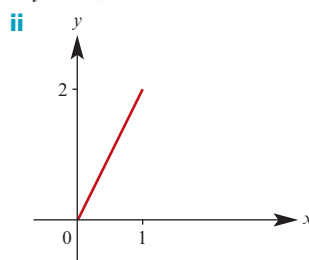

iii Particle starts at $(1, 2)$ and moves along a linear path towards the origin. When it reaches $(0, 0)$, it reverses direction and heads towards $(1, 2)$. It continues in this pattern, taking $\frac{1}{3}$ units of time to complete each cycle.

b i $y = 2x^2 - 1$, $-1 \leq x \leq 1$

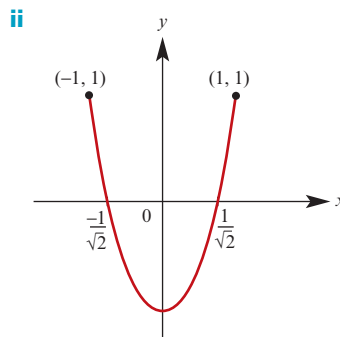

iii Particle is moving along a parabolic path, starting at $(1, 1)$ and reversing direction at $(-1, 1)$. It takes 1 unit of time for each cycle.

c i $y = \frac{1}{x^2}$, $x \geq 1$

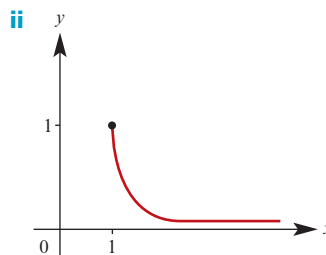

iii Particle is moving along a 'truncus' path, starting at $(1, 1)$ and moving to the 'right' indefinitely.

Exercise 16C

1 a $\dot{r}(t) = e^t\mathbf{i} - e^{-t}\mathbf{j}$, $\ddot{r}(t) = e^t\mathbf{i} + e^{-t}\mathbf{j}$

b $\dot{r}(t) = \mathbf{i} + 2t\mathbf{j}$, $\ddot{r}(t) = 2\mathbf{j}$

c $\dot{r}(t) = \frac{1}{2}\mathbf{i} + 2t\mathbf{j}$, $\ddot{r}(t) = 2\mathbf{j}$

d $\dot{r}(t) = 16\mathbf{i} - 32(4t - 1)\mathbf{j}$, $\ddot{r}(t) = -128\mathbf{j}$

e $\dot{r}(t) = \cos t\mathbf{i} - \sin t\mathbf{j}$,
 $\ddot{r}(t) = -\sin t\mathbf{i} - \cos t\mathbf{j}$

f $\dot{r}(t) = 2\mathbf{i} + 5\mathbf{j}$, $\ddot{r}(t) = \mathbf{0}$

g $\dot{r}(t) = 100\mathbf{i} + (100\sqrt{3} - 9.8t)\mathbf{j}$, $\ddot{r}(t) = -9.8\mathbf{j}$

h $\dot{r}(t) = \sec^2 t \mathbf{i} - \sin(2t) \mathbf{j}$,
 $\ddot{r}(t) = (2 \sec^2 t \tan t) \mathbf{i} - 2 \cos(2t) \mathbf{j}$

2 a $r(t) = e^t \mathbf{i} + e^{-t} \mathbf{j}$

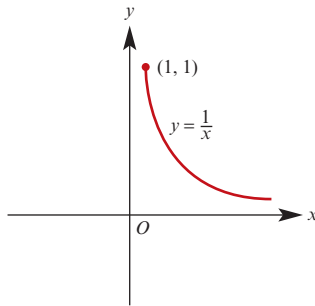

$r(0) = \mathbf{i} + \mathbf{j}$, $\dot{r}(0) = \mathbf{i} - \mathbf{j}$, $\ddot{r}(0) = \mathbf{i} + \mathbf{j}$

b $r(t) = t\mathbf{i} + t^2\mathbf{j}$

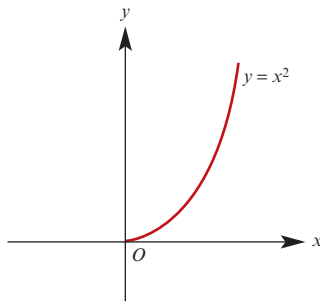

$r(1) = \mathbf{i} + \mathbf{j}$, $\dot{r}(1) = \mathbf{i} + 2\mathbf{j}$, $\ddot{r}(1) = 2\mathbf{j}$

c $r(t) = \sin t \mathbf{i} + \cos t \mathbf{j}$

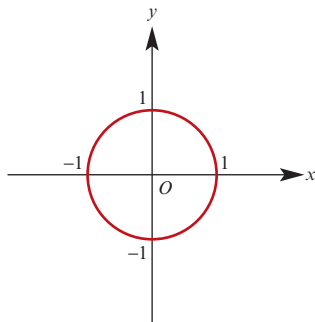

$r\left(\frac{\pi}{6}\right) = \frac{1}{2}\mathbf{i} + \frac{\sqrt{3}}{2}\mathbf{j}$, $\dot{r}\left(\frac{\pi}{6}\right) = \frac{\sqrt{3}}{2}\mathbf{i} - \frac{1}{2}\mathbf{j}$,

$\ddot{r}\left(\frac{\pi}{6}\right) = -\frac{1}{2}\mathbf{i} - \frac{\sqrt{3}}{2}\mathbf{j}$

d $r(t) = 16t\mathbf{i} - 4(4t - 1)^2\mathbf{j}$

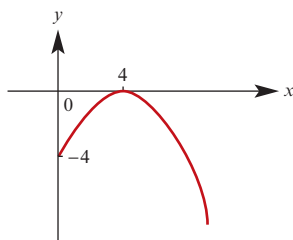

$r(1) = 16\mathbf{i} - 36\mathbf{j}$, $\dot{r}(1) = 16\mathbf{i} - 96\mathbf{j}$,
 $\ddot{r}(1) = -128\mathbf{j}$

e $r(t) = \frac{1}{t+1}\mathbf{i} + (t+1)^2\mathbf{j}$

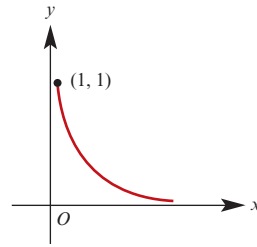

$r(1) = \frac{1}{2}\mathbf{i} + 4\mathbf{j}$, $\dot{r}(1) = -\frac{1}{4}\mathbf{i} + 4\mathbf{j}$,

$\ddot{r}(1) = \frac{1}{4}\mathbf{i} + 2\mathbf{j}$

3 a -1 **b** Undefined **c** $-2e^{-3}$

d $\frac{1}{2}$ **e** 4 **f** $2\sqrt{2}$

4 a $r(t) = (4t + 1)\mathbf{i} + (3t - 1)\mathbf{j}$

b $r(t) = (t^2 + 1)\mathbf{i} + (2t - 1)\mathbf{j} - t^3\mathbf{k}$

c $r(t) = \frac{1}{2}e^{2t}\mathbf{i} + 4(e^{0.5t} - 1)\mathbf{j}$

d $r(t) = \left(\frac{t^2 + 2t}{2}\right)\mathbf{i} + \frac{1}{3}t^3\mathbf{j}$

e $r(t) = -\frac{1}{4}\sin(2t)\mathbf{i} + 4\cos\left(\frac{1}{2}t\right)\mathbf{j}$

6 a $t = 0, 2$

b $\dot{r}(0) = 2\mathbf{i}$ and $\ddot{r}(0) = 96\mathbf{j}$;

$\dot{r}(2) = 2\mathbf{i}$ and $\ddot{r}(2) = -96\mathbf{j}$

7 a

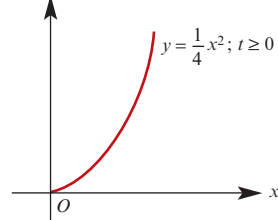

b $t = \frac{2}{a}$

8 a

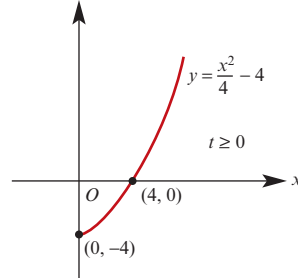

b 45° **c** $t = \sqrt{3}$

9 a $\dot{r} = 3\mathbf{i} + t^2\mathbf{j} + 3t^2\mathbf{k}$ **b** $|\dot{r}| = \sqrt{9 + 10t^4}$

c $\ddot{r} = 2t\mathbf{j} + 6t\mathbf{k}$ **d** $|\ddot{r}| = 2\sqrt{10}t$

e $t = \frac{4\sqrt{10}}{5}$

10 a $\dot{r} = V \cos \alpha \mathbf{i} + (V \sin \alpha - gt) \mathbf{j}$ b $\ddot{r} = -g\mathbf{j}$
 c $t = \frac{V \sin \alpha}{g}$
 d $r = \frac{V^2 \sin(2\alpha)}{2g} \mathbf{i} + \frac{V^2 \sin^2 \alpha}{2g} \mathbf{j}$

Exercise 16D

- 1 a $2t\mathbf{i} - 2\mathbf{j}$ b $2\mathbf{i}$ c $2\mathbf{i} - 2\mathbf{j}$
 2 a $2\mathbf{i} + (6 - 9.8t)\mathbf{j}$
 b $2t\mathbf{i} + (6t - 4.9t^2 + 6)\mathbf{j}$
 3 a $2\mathbf{j} - 4\mathbf{k}$
 b $3t\mathbf{i} + (t^2 + 1)\mathbf{j} + (t - 2t^2 + 1)\mathbf{k}$
 c $\sqrt{20t^2 - 8t + 10}$
 d i $\frac{1}{5}$ seconds ii $\frac{1}{5}\sqrt{230}$ m/s
 4 a $(10t + 20)\mathbf{i} - 20\mathbf{j} + (40 - 9.8t)\mathbf{k}$
 b $(5t^2 + 20t)\mathbf{i} - 20t\mathbf{j} + (40t - 4.9t^2)\mathbf{k}$
 5 Speed = $10t$
 6 45°
 7 Minimum speed = $3\sqrt{2}$ m/s;
 position = $24\mathbf{i} + 8\mathbf{j}$
 8 a $t = 61\frac{11}{49}$ s b 500 m/s c $\frac{225\,000}{49}$ m
 d 500 m/s e $\theta = 36.87^\circ$
 9 a $r(t) = (\frac{1}{3} \sin(3t) - 3)\mathbf{i} + (\frac{1}{3} \cos(3t) + \frac{8}{3})\mathbf{j}$
 b $(x + 3)^2 + (y - \frac{8}{3})^2 = \frac{1}{9}$; centre $(-3, \frac{8}{3})$
 10 Max speed = $2\sqrt{5}$ m/s; min speed = $2\sqrt{2}$ m/s
 11 a Magnitude $\frac{\sqrt{11667}}{9}$ m/s²;
 direction $\frac{1}{\sqrt{11667}}(108\mathbf{i} - \sqrt{3}\mathbf{j})$
 b $r(t) = (\frac{4}{3}t^3 + 2t^2 + t)\mathbf{i} + (\sqrt{2t + 1} - 1)\mathbf{j}$
 12 a $t = 6$ b $7\mathbf{i} + 12\mathbf{j}$
 13 a $-16\mathbf{i} + 12\mathbf{j}$ b $-80\mathbf{i} + 60\mathbf{j}$
 14 a $8 \cos(2t)\mathbf{i} - 8 \sin(2t)\mathbf{j}$, $t \geq 0$
 b 8 c $-4\mathbf{r}$
 15 a $(t^2 - 5t - 2)\mathbf{i} + 2\mathbf{j}$ b $-\frac{33}{4}\mathbf{i} + 2\mathbf{j}$
 c $y = 2$ with $x \geq -8.25$
 16 a $\frac{x^2}{36} - \frac{y^2}{16} = 1$
 b $6 \tan t \sec^2 t \mathbf{i} + 4 \sec^2 t \mathbf{j}$, $t \geq 0$
 17 a $\frac{x^2}{16} + \frac{y^2}{9} = 1$

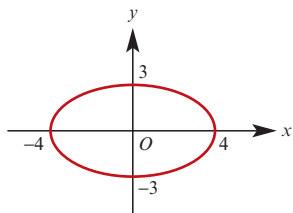

b i $t = 0, \frac{\pi}{2}, \pi, \frac{3\pi}{2}, 2\pi$
 ii $r(0) = 4\mathbf{i}$, $r(\frac{\pi}{2}) = 3\mathbf{j}$, $r(\pi) = -4\mathbf{i}$,
 $r(\frac{3\pi}{2}) = -3\mathbf{j}$, $r(2\pi) = 4\mathbf{i}$
 c i $\sqrt{9 + 7 \sin^2 t}$ ii $\sqrt{16 - 7 \cos^2 t}$
 iii Max speed 4 m/s; min speed 3 m/s

Exercise 16E

- 1 a $\dot{r}(0) = 49\sqrt{3}\mathbf{i} + 49\mathbf{j}$
 b $\dot{r}(t) = 49\sqrt{3}\mathbf{i} + (49 - 9.8t)\mathbf{j}$
 c $r(t) = 49\sqrt{3}t\mathbf{i} + (49t - 4.9t^2)\mathbf{j}$
 d $y = \frac{\sqrt{3}}{3}x - \frac{1}{1470}x^2$
 2 a $y = -\frac{1}{150g}x^2 + \frac{\sqrt{3}}{3}x + 50$
 b $25\sqrt{3}(\sqrt{g^2 + 2g} + g)$
 3 $\frac{25g}{8}$ m
 4 a $r(t) = 40 \cos(20^\circ)t\mathbf{i} - (40 \sin(20^\circ)t + \frac{gt^2}{2})\mathbf{j}$
 b 31.7 m c 25.4°
 5 16.3° or 87.8°
 6 a $\dot{r} = u \cos \alpha \mathbf{i} + (u \sin \alpha - gt)\mathbf{j}$
 b $T = \frac{u}{g \sin \alpha}$
 8 $13\sqrt{\frac{g}{5}}$ m/s
 9 a 4.9 m b 37.5 m/s
 10 a $r = 16t\mathbf{i} + (30t - \frac{gt^2}{2})\mathbf{j}$
 b $t = 2.5$; $r(2.5) = 40\mathbf{i} + (75 - \frac{25g}{8})\mathbf{j}$
 11 a $v = u + t\mathbf{g}$ b $r = tu + \frac{1}{2}t^2\mathbf{g}$

Exercise 16F

- 1 a 2 radians per second b $2.5\mathbf{i}$
 c $5\mathbf{j}$ d $-10\mathbf{i}$
 2 a 1 radian per second b $2\mathbf{j}$
 c $2\mathbf{i}$ d $-2\mathbf{j}$
 3 a $\frac{35\pi}{3}$ radians per second b $\frac{7\pi}{6}$ m/s
 4 a $r = 25(\cos(\frac{2t}{5})\mathbf{i} + \sin(\frac{2t}{5})\mathbf{j})$
 b $\dot{r} = 10(-\sin(\frac{2t}{5})\mathbf{i} + \cos(\frac{2t}{5})\mathbf{j})$
 c $\ddot{r} = 4(-\cos(\frac{2t}{5})\mathbf{i} - \sin(\frac{2t}{5})\mathbf{j})$
 5 $\frac{100}{3}$ radians per second
 6 a 3π radians per second b 6π m/s
 c $18\pi^2$ m/s² d $\frac{2}{3}$ s

- 7 a** 12π m/s **b** $48\pi^2$ m/s²
c $r(\frac{1}{2}) = -3j$; $\dot{r}(\frac{1}{2}) = 12\pi i$; $\ddot{r}(\frac{1}{2}) = 48\pi^2 j$
d 4π radians per second
- 8 a** $a = 2$, $n = \frac{8\pi}{3}$ **b** $\frac{16\pi}{3}$ m/s
c $\frac{128\pi^2}{9}$ m/s²
- 9 a** Circle with centre (0, 0) and radius 4
b $\dot{r} = -8t \sin(t^2)i + 8t \cos(t^2)j$
c $\ddot{r} = -4t^2 r + \frac{1}{t} \dot{r}$
- 10 a** 12π m/s
b $48\pi^2$ m/s²
c $r(1) = 7i + 2j$; $\dot{r}(1) = -12\pi j$;
 $\ddot{r}(1) = -48\pi^2 i$
d 4π radians per second
e $(x-4)^2 + (y-2)^2 = 9$

Chapter 16 review

Short-answer questions

- 1 a** $2i + 4j$, $2j$ **b** $4y = x^2 - 16$
- 2 a** $\dot{r}(t) = 4ti + 4j$, $\ddot{r}(t) = 4i$
b $\dot{r}(t) = 4 \cos t i - 4 \sin t j + 2tk$,
 $\ddot{r}(t) = -4 \sin t i - 4 \cos t j + 2k$
- 3** $0.6i + 0.8j$
- 4 a** $5\sqrt{3}i + \frac{5}{2}j$ **b** $\frac{2\sqrt{7}}{7}$
- 5** $\cos t i + \sin t j$
- 6 a** $5(-\sin t i + \cos t j)$ **b** 5
c $-5(\cos t i + \sin t j)$
d 0, acceleration perpendicular to velocity
- 7** $\frac{3\pi}{4}$
- 8 a** $|\dot{r}| = 1$, $|\ddot{r}| = 1$
b $(x-1)^2 + (y-1)^2 = 1$ **c** $\frac{3\pi}{4}$
- 9** $-2i + 20j$
- 10 a** $r = (\frac{t^2}{2} + 1)i + (t-2)j$ **b** (13.5, 3)
c 12.5 s
- 11 a** $\dot{r} = ti + (2t-5)j$
b $r = (\frac{t^2}{2} - 1)i + (t^2 - 5t + 6)j$
c $-i + 6j$, $-5j$
- 12 a i** $\dot{r}_2(t) = (2t-4)i + tj$
ii $\dot{r}_1(t) = ti + (k-t)j$
b i 4 **ii** 8 **iii** $4(i+j)$
- 13 b i** $\dot{r}(t) = e^t i + 8e^{2t} j$ **ii** $i + 8j$ **iii** $\ln 1.3$
- 14 b i** $x = 2$ for $y \geq -3.5$ **ii** (2, -3.5)
- 15 a** 6π m/s **b** $12\pi^2$ m/s²
c $r(1) = 3j$; $\dot{r}(1) = 6\pi i$; $\ddot{r}(1) = -12\pi^2 j$
d 2π radians per second

Multiple-choice questions

- 1** E **2** E **3** B **4** E **5** C **6** C
7 C **8** E **9** C **10** E **11** E **12** E

Extended-response questions

- 1 a** Speed of P is $3\sqrt{13}$ m/s;
 speed of Q is $\sqrt{41}$ m/s
b i Position of P is $60i + 20j$;
 position of Q is $80i + 80j$
ii $\vec{PQ} = (20-4t)i + (60-2t)j$
c 10 seconds, $20\sqrt{5}$ metres
- 2 a** $\vec{AB} = ((v+3)t-56)i + ((7v-29)t+8)j$
b 4
c i $\vec{AB} = (6t-56)i + (8-8t)j$
ii 4 seconds
- 3 a** $\vec{BF} = -3i + 6j - 6k$ **b** 9 m
c 3 m/s **d** $(-i + 2j - 2k)$ m/s
e 2 seconds, $2\sqrt{26}$ metres
- 4 a i** 200 s **ii** $\frac{1}{2}$ **iii** 5 m/s **iv** (1200, 0)
b 8 seconds, $\frac{72}{2}$ metres
- 5 a i** $\vec{OA} = (6t-1)i + (3t+2)j$
ii $\vec{BA} = (6t-3)i + (3t+1)j$
b 1 second
c i $c = \frac{1}{5}(3i+4j)$ **ii** $d = \frac{1}{5}(4i-3j)$
iii $6c + 3d$

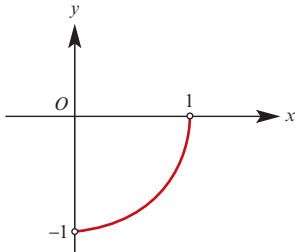
- 6 a**
- 
- b i** $a = 16$ **ii** $b = -16$ **iii** $n = 2$
iv $v(t) = -32 \sin(2t)i - 32 \cos(2t)j$
 $a(t) = -64 \cos(2t)i + 64 \sin(2t)j$
- c i** $\vec{PQ} = 8((\sin t - 2 \cos(2t))i + (\cos t + 2 \sin(2t))j)$
ii $|\vec{PQ}|^2 = 64(5 + 4 \sin t)$
d 8 cm
- 7 a** $2 \sin t i + (\cos(2t) + 2)j$, $t \geq 0$
b $2i + j$
c i $y = 3 - \frac{x^2}{2}$, $-2 \leq x \leq 2$
ii

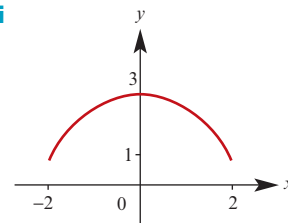

d $|v|^2 = -16 \cos^4 t + 20 \cos^2 t$,
max speed is $\frac{5}{2}$

e $\frac{3\pi}{2}$

f ii $t = \frac{(2k-1)\pi}{2}$, $k \in \mathbb{N}$

- 8 a** $a\mathbf{i} + (b+2t)\mathbf{j} + (20-10t)\mathbf{k}$
b $at\mathbf{i} + (bt+t^2)\mathbf{j} + (20t-5t^2)\mathbf{k}$ **c** 4 s
d $a = 25, b = -4$ **e** 38.3°

- 9 a i** Particle P is moving on a circular path, with centre $(0, 0, -1)$ and radius 1, starting at $(1, 0, -1)$ and moving 'anticlockwise' a distance of 1 'below' the x - y plane. The particle finishes at $(1, 0, -1)$ after one revolution.

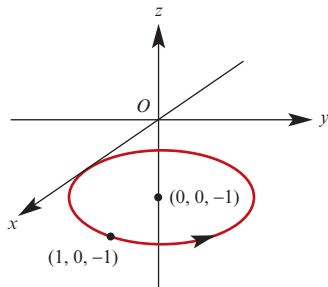

ii $\sqrt{2}$

iii $\dot{\mathbf{p}}(t) = -\sin t \mathbf{i} + \cos t \mathbf{j}$, $0 \leq t \leq 2\pi$

v $\ddot{\mathbf{p}}(t) = -\cos t \mathbf{i} - \sin t \mathbf{j}$, $0 \leq t \leq 2\pi$

b i $\vec{PQ} = (\cos(2t) - \cos t)\mathbf{i} + (-\sin t - \sin(2t))\mathbf{j} + \frac{3}{2}\mathbf{k}$

iii $\frac{5}{2}$ **iv** $\frac{\pi}{3}, \pi, \frac{5\pi}{3}$ **v** $\frac{3}{2}$

vi $0, \frac{2\pi}{3}, \frac{4\pi}{3}, 2\pi$

c ii $\frac{\sqrt{10}}{5}(\cos(3t) - \frac{1}{2})$ **iii** 162°

10 a $\mathbf{r}(t) = 35t\mathbf{i} + 5t\mathbf{j} + (24.5t - 4.9t^2)\mathbf{k}$

b 5 s **c** 35 m **d** 43.0 m/s

11 a 4α

b A: $y = \frac{x}{2}$, $x \geq 0$;

B: $(x-4)^2 + y^2 = 16$

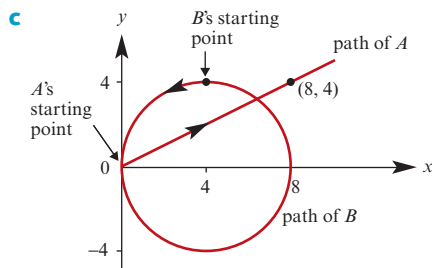

d $(0, 0), (\frac{32}{5}, \frac{16}{5})$

e 1.76

12 a i $-9.8\mathbf{j}$ **ii** $2\mathbf{i} - 9.8t\mathbf{j}$ **iii** $2t\mathbf{i} - 4.9t^2\mathbf{j}$

b i $\frac{2\sqrt{2}}{7}$ seconds **ii** $\frac{4\sqrt{2}}{7}$ metres

13 a i $6\mathbf{i} - 3\mathbf{j}$ **ii** $\frac{\sqrt{5}}{5}(2\mathbf{i} - \mathbf{j})$

b $4\mathbf{i} - 2\mathbf{j}$, $(4, -2)$

c i $\vec{LP} = (1 - \frac{7}{2}t)\mathbf{i} + (7 - 2t)\mathbf{j}$ **ii** 1:05 p.m.

iii $\frac{9\sqrt{65}}{13}$ km

Chapter 17

Exercise 17A

- 1 a i** $5\mathbf{i} + 5\mathbf{j}$ **ii** $5\sqrt{2} \approx 7.07$ N; 45°
b i $-4\mathbf{i} - 4\mathbf{j}$ **ii** $4\sqrt{2} \approx 5.66$ N; 225°
c i $-\mathbf{i} - 5\mathbf{j}$ **ii** $\sqrt{26} \approx 5.10$ N; 258.7°
d i $3\mathbf{i} + 10\mathbf{j}$ **ii** $\sqrt{109} \approx 10.44$ N; 73.3°
e i $-4\mathbf{j}$ **ii** 4 N; 270°
f i $10\mathbf{i}$ **ii** 10 N; 0°

2 $\mathbf{R} = (11\mathbf{i} - 3\mathbf{j})$ N

3 25.43 N

4 $\frac{\sqrt{781} - 9}{2} \approx 9.5$ N

5 $\mathbf{F}_3 = -2\mathbf{i} + \mathbf{k}$

6 386 N

7 a i $6.064\mathbf{i} + 2.57\mathbf{j}$ **ii** 6.59 N; 22.98°

b i $19.41\mathbf{i} + 7.44\mathbf{j}$ **ii** 20.79 N; 20.96°

c i $1.382\mathbf{i} + 5.394\mathbf{j}$ **ii** 5.57 N; 75.63°

d i $2.19\mathbf{i} - 2.19\mathbf{j}$ **ii** 3.09 N; 315°

e i 18.13i **ii** 18.13 N; 0°

f i $-2.15\mathbf{i} - 1.01\mathbf{j}$ **ii** 2.37 N; 205.28°

9 a $5\mathbf{j}$ **b** 5 N; 90°

10 a 11.28 N **b** 6.34 N **c** 0 N **d** -9.01 N

11 a 17.72 N **b** 14.88 N

12 a $\frac{11}{5}(2\mathbf{i} - \mathbf{j})$ **b** $\frac{-6}{25}(3\mathbf{i} + 4\mathbf{j})$

13 a -1.97 N **b** 5.35 N **c** -0.48 N

14 -3.20 N

15 a 32.15 N **b** 33.23 N

16 a 4.55 N; 19.7° **b** 12.42 N; 63.5°

17 15.46 N

18 a 6.93 N **b** 14 N

19 1.15 N

Exercise 17B

1 a 10 kg m/s **b** 0.009 kg m/s

c $8333\frac{1}{3}$ kg m/s **d** 60 kg m/s

e $41\ 666\frac{2}{3}$ kg m/s

2 a $10(\mathbf{i} + \mathbf{j})$ kg m/s

b i $10(5\mathbf{i} + 12\mathbf{j})$ kg m/s **ii** 130 kg m/s

- 3 a** -30 kg m/s **b** 40 kg m/s **c** 90 kg m/s
4 a $5g \approx 49 \text{ N}$ **b** $3000g \approx 29\,400 \text{ N}$
c $0.06g \approx 0.588 \text{ N}$
5 a 32 N **b** $\frac{1}{2} \text{ m/s}^2$
6 a 4 **b** 7
7 $\frac{96}{1.2 + g} \approx 8.73 \text{ kg}$ **8** 660 N
9 2.076 kg wt **10** $5.4 \times 10^{-14} \text{ N}$
11 a $= i + 5j \text{ m/s}^2$ **12 a** $= i - \frac{2}{5}j \text{ m/s}^2$
13 a 2.78 kg wt **b** 3.35 kg wt
14 $-34\,722\frac{2}{9} \text{ N}$ **15** $F_3 = 19.6i - j$
16 113 N **17** 5 N
18 a $= \frac{7}{2}i + 2j \text{ m/s}^2$ **19** $\frac{1}{2} \text{ m/s}$
20 663 N
21 a $\frac{g}{5} \approx 1.96 \text{ m/s}^2$ **b** 19.6 m/s
22 42.517 s
23 Pushing force = 62.5 N ; Resistance = 25 N
24 $60\,000 \text{ N}$; -0.1 m/s^2
25 $\frac{5}{49}$
26 a 0.0245 N **b** 5.1 m/s
27 0.612
28 a $200g \approx 1960 \text{ N}$ **b** 2060 N
29 a 2 m/s^2 **b** 1.06 m/s^2

Exercise 17C

- 1** 7.3 N ; 18.4°
2 a $\sqrt{3} \text{ m/s}^2$ **b** 1.124 m/s^2
3 $g \cos 45^\circ \approx 6.93 \text{ m/s}^2$
4 $\frac{\sqrt{2}(1 - \mu)g}{2} \text{ m/s}^2$
5 3.9 m/s^2 ; 84.9 N
6 29.223 N
7 $\sqrt{2}g \text{ N}$
8 181 N
9 $a = \frac{P}{m} - \mu g \cos \theta - g \sin \theta$
10 $a = -\frac{g}{2}i$
11 6.76 m/s
12 8.84 m ; 4.31 m/s
13 a $\frac{\sqrt{40gx}}{5} \text{ m/s}$ **b** $\frac{8x}{3} \text{ m}$
14 a $a = \frac{F}{M}(\cos \theta + \mu \sin \theta) - \mu g$
b $a = \frac{F}{M}(\cos \theta - \mu \sin \theta) - \mu g$
15 a 490 N **b** 1980 N
16 a $\frac{100}{9g} \approx 1.13 \text{ m}$ **b** $2\sqrt{3} \approx 3.46 \text{ m/s}$

- 17** $8 + 4\sqrt{3} \approx 14.93 \text{ N}$
18 a 40.49 N **b** 1.22 m/s^2

Exercise 17D

- 1 a** $\frac{80g}{9} \approx 87.1 \text{ N}$ **b** $\frac{g}{9} \approx 1.09 \text{ m/s}^2$
2 a $\frac{10}{11} \approx 0.91 \text{ m/s}^2$
b $S = T = \frac{50}{11} \approx 4.55 \text{ N}$
3 a 16.8 N **b** 1.4 m/s^2
4 a 2.92 **b** 25.71 N
5 a $\frac{98}{15} \text{ m/s}^2$ **b** $26\frac{2}{15} \text{ N}$
6 a 19.6 N **b** 4.9 m/s^2
7 a 0.96 m/s^2 **b** 39.4 N
8 2.67 kg
9 a $10\,750 \text{ N}$ **b** 9250 N
10 5.28 kg
11 a 0.025 m/s^2 **b** $10\,000 \text{ N}$
12 a $\frac{8g}{5} \approx 15.7 \text{ N}$ **b** $4g \approx 39.2 \text{ N}$
c $\frac{g}{5} \approx 1.96 \text{ m/s}^2$
13 0.305
14 a $\mu = 0.86$ **b** 52.8 N
15 a 16.296 N **b** $\mu = 0.35$

Exercise 17E

- 1** $33\frac{1}{3} \text{ m/s}$; 250 m
2 a $x = 6t - 2 \sin t$ **b** $\pm 4\sqrt{3} \text{ m/s}$
c $x = \frac{1}{4}(2t^2 - \cos(2t) + 1)$
3 $\frac{110}{9} \text{ m/s}$; $(\frac{400}{3} - \frac{50}{3} \ln 3) \text{ m}$
4 $x = \frac{t^2}{2} + 16 \sin(\frac{t}{4}) - 4t$
5 a $\dot{x} = t - 2 \sin(\frac{1}{2}t)$
b $x = \frac{t^2}{2} + 4 \cos(\frac{1}{2}t) - 4$
6 10 m/s
7 $10 - \ln 11 \approx 7.6 \text{ m/s}$
8 a $v = 4(1 - e^{-0.5t}) \text{ m/s}$

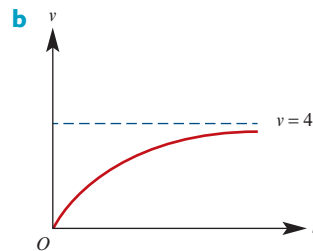

c Approx 112 m

9 a 5.5 **b** $\frac{275}{6} - 10 \ln 2$

10 $\frac{um}{k} (e^{\frac{kt}{m}} - 1)$ metres

11 $V - \frac{k}{m}x$

12 $\frac{b}{c} (1 - e^{-\frac{ct}{m}})$ m/s; $\frac{b}{c}$ m/s

13 Max height = $\frac{m}{2k} \ln \left(1 + \frac{ku^2}{mg} \right)$;

speed = $u \sqrt{\frac{mg}{ku^2 + mg}}$

15 b $\frac{4375}{3}$

c $1000 \ln 2 + \frac{4375}{3} \approx 2151.48$

Exercise 17F

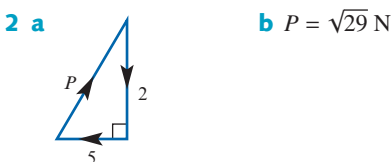
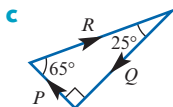
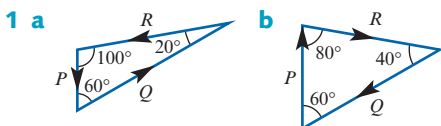

c $180^\circ - \tan^{-1} \left(\frac{2}{5} \right) \approx 158.20^\circ$

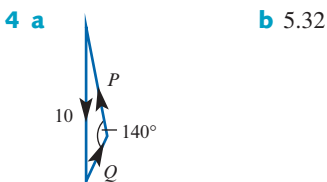
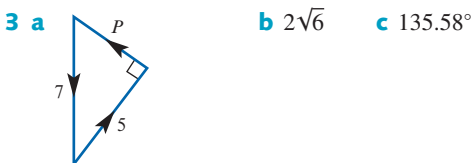

5 a $P = 4.60$ N, $Q = 1.31$ N

b $P = 6.13$ N, $Q = 2.23$ N

6 18.13 N

7 66.02 N

9 a Along the bisector of the angle between the forces (rhombus property)

b 18.13 N

c 18.13 N, making an angle of 155° with each of the 10 N forces

10 $P = 13.40$ N, $Q = 16.51$ N

11 $P = 16.16$ N, $Q = 7.99$ N

12 a **b** 149.25°

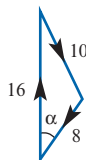

13 a **b** 5.37 N **c** 146.59

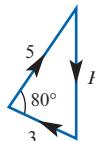

14 $P = 42.09$; tension = 50.82 N

15 45.23 N

16 a 169.67° **b** 2.81 N

Exercise 17G

1 a $2i - 3j$ **b** $\sqrt{13}$ **c** $v = 2ti - 3tj$

d $|v| = \sqrt{13}$ **e** 303.69°

2 a $2i + 3j$ **b** $2ti + 3tj$

c $t^2i + \frac{3t^2}{2}j$ **d** $y = \frac{3x}{2}, x \geq 0$

3 a $r(0) = 8j$ **b** $y = \frac{2x}{5} + 8, x \geq 0$

c $F = 20i + 8j$ N

4 a $r(0) = 25i + 10j$ **b** $y = 35 - x, x \leq 25$

c $-50i + 50j$ N

5 a $\left(\frac{3}{2}i - \frac{1}{2}j\right)$ m/s² **b** $\left(\frac{3}{2}ti - \frac{1}{2}tj\right)$ m/s

c $\left(\frac{3}{4}t^2 + 2\right)i - \left(\frac{1}{4}t^2 + 2\right)j$

6 a $\left(8i + \frac{8}{3}j\right)$ m/s²

b i $\left(80i + \frac{80}{3}j\right)$ N **ii** $\frac{80\sqrt{10}}{3}$ N

7 a $y = \frac{x}{2} + 6, x \geq 0$ **b** $r(t) = 4ti + 2tj$

c $t = 8$ **d** $8i + 4j$ N

8 a $0.15i + 0.25j$ m/s²

b $(3 + 0.15t)i + (5 + 0.25t)j$ m/s

c $20.7i + 34.5j$ **d** $y = \frac{5}{3}x, x \geq -30$

9 15 m/s; $5\sqrt{10}$ m/s

Chapter 17 review

Short-answer questions

1 a 885 N **b** 6785 N

2 a $\frac{g}{4}$ m/s² **b** $\frac{15g}{4}$ N

4 a $(10 - 0.4g)$ m/s² **b** $(5 - 0.4g)$ m/s²

5 a $\frac{4}{(t+1)^2}$ m/s² **b** $\frac{4t}{t+1}$ m/s

c $(4t - 4 \ln(t+1))$ m

- 6 2000 N
 7 $\tan \theta, \frac{g}{\cos \theta} \sin(\varphi - \theta)$
 8 a $\frac{g}{4} \text{ m/s}^2$ b Particle lowered with $a \geq \frac{g}{6}$
 9 4 m/s
 10 a $(i + 2j) \text{ m/s}^2$
 b i $(t + 1)(i + 2j) \text{ m/s}$ ii $\sqrt{5}(t + 1) \text{ m/s}$
 c $\left(\frac{t^2}{2} + t\right)(i + 2j) \text{ m}$
 d $y = 2x, x \geq 0$
 11 $204\frac{1}{6} \text{ m}$ 12 2250 N 13 $\frac{10\,000}{3g}$
 14 $m(g + f) \text{ N}$ 15 $100\sqrt{2} \text{ m/s}$
 16 a 9 kg wt b $\frac{g}{9} \text{ m/s}^2$
 17 a Down with acceleration $\frac{(m_1 - m_2)g}{m_1 + m_2} \text{ m/s}^2$
 b $\frac{2m_1m_2g}{m_1 + m_2} \text{ N}$
 18 a Acceleration $\frac{m_1g}{m_1 + m_2} \text{ m/s}^2$
 b $\frac{m_1m_2g}{m_1 + m_2} \text{ N}$
 19 a Moves up plane with acceleration $\frac{(m_1 - m_2 \sin \alpha)g}{m_1 + m_2} \text{ m/s}^2$
 b $\frac{m_1m_2g(1 + \sin \alpha)}{m_1 + m_2} \text{ N}$
 20 $(\sin \alpha - \mu \cos \alpha)g$
 21 a $\frac{3g}{8} \text{ m/s}^2$ b $\frac{15g}{4} \text{ N}$
 c $\frac{15g\sqrt{2}}{4} \text{ N}$ at 45° to the horizontal
 d $\frac{4}{\sqrt{3}g} \text{ s}$ e $\frac{6}{\sqrt{3}g} \text{ s}$
 22 a $\frac{g(5\sqrt{3} - 3)}{13} \text{ m/s}^2$ b $\frac{3g(10 + 5\sqrt{3})}{13} \text{ N}$
 23 a $\frac{g}{4} \text{ m/s}^2$ b $\frac{\sqrt{2}g}{2} \text{ m/s}$ c $\frac{5}{4} \text{ m}$
 25 $5g\sqrt{3} \text{ N}$
 26 $\frac{8g}{3} \text{ N}, \frac{10g}{3} \text{ N}$
 27 $\frac{60g}{13} \text{ N}, \frac{25g}{13} \text{ N}$

Multiple-choice questions

- 1 D 2 E 3 B 4 B 5 D
 6 B 7 B 8 B 9 B 10 C

Extended-response questions

- 1 a 2.8 N
 b 0.7 m/s^2
 c i $\sqrt{\frac{20}{21 - 2g}} \text{ s}$ ii $\sqrt{5(21 - 2g)} \text{ m/s}$
 d 0.357 metres

- 2 a i $0.3g = 2.94 \text{ m/s}^2$ ii $2.1g \text{ N}$
 b 8.26875 m
 3 a i $\frac{8g}{15} \text{ m/s}^2$ ii $\frac{14g}{75} \text{ N}$
 b 2 m
 4 a i 6888 N ii 948 N
 b i 14 088 N ii 2148 N
 5 b ii 8.96
 6 a $x = 25 \ln\left(\frac{50g}{50g - v^2}\right)$
 b $v = \sqrt{50g(1 - e^{-\frac{x}{25}})}$

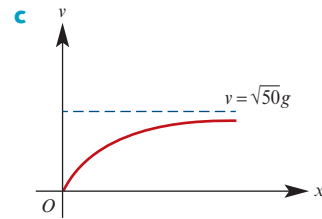

- 7 a $2 - \sqrt{3}$
 b $200 \leq M \leq 100(\sqrt{3} + 1)$
 c i $\frac{g}{7} \text{ m/s}^2$ ii $\frac{1200g}{7} \text{ N}$ iii 30.54 m/s
 8 a $\frac{25}{2}e^{-0.1t} \text{ m/s}^2$
 b i $625(4 + e^{-0.1t})$ ii $5(625 - v)$
 iii 3025 N iv $625(4 + e^{-3}) \approx 2531.12 \text{ N}$
 c $P(N)$

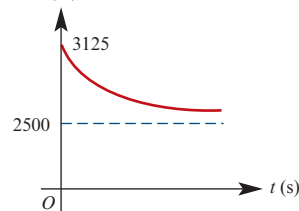

- 9 a $R = Mg \cos \alpha - T \sin \theta$
 b $T = \frac{Mg \sin \alpha + 0.1Mg \cos \alpha}{\cos \theta + 0.1 \sin \theta}$
 c i $T = \frac{8.6g}{\cos \theta + 0.1 \sin \theta}$ ii 5.7°
 iii $\frac{86\sqrt{101}}{101} g \text{ N}$
 d 5.7°
 10 a i $\frac{600g}{13} \text{ N}$ ii $\frac{60g}{13} \text{ N}$
 b $\frac{19g}{65} \text{ m/s}^2$
 c i $\frac{14\sqrt{1235}}{65} \text{ m/s}$ ii 2.64 seconds
 d i $(8.86 - 5t) \text{ m/s}^2$ ii 1.86 s

Chapter 18

Short-answer questions

- 1 **a** $v(t) = \cos t \mathbf{i} + \cos(2t) \mathbf{j}$
b $a(t) = -\sin t \mathbf{i} - 2 \sin(2t) \mathbf{j}$
c $d(t) = |\sin t| \sqrt{2 - \sin^2 t}$
d $s(t) = \sqrt{2 - 5 \sin^2 t} + 4 \sin^4 t$
e $y^2 = x^2(1 - x^2)$
- 2 **a** 440 N **b** 540 N
- 3 **a** $\frac{v-5}{10}$ **b** $v = 5 - 5e^{\frac{t}{10}}$
- 4 $T = \frac{5g}{2}$
- 5 **a** $\frac{x^2}{4} - 4y^2 = 1, x \geq 2, y \geq 0$
b $v(t) = 2 \tan t \sec t \mathbf{i} + 0.5 \sec^2 t \mathbf{j}$
c $2\sqrt{13} \text{ m/s}$
- 6 $v = -2\sqrt{t+1}$
- 7 $x(\ln 2) = \frac{5}{2} \mathbf{i} + \mathbf{j} - \frac{19}{8} \mathbf{k}$
- 8 **b** $y = \sqrt{3}x - \frac{g}{200}x^2$
- 9 $4\sqrt{5} \text{ newtons}$
- 10 **a** $\frac{100}{19} \text{ N}$ **b** $\frac{50 - 19g}{38} \text{ m/s}^2$
- 11 $\frac{64(4 - \sqrt{3})}{13g}$
- 12 **a** $\mu = \frac{u^2 - 2gx \sin \theta}{(2gx \cos \theta)}$
b x increased by 44%
- 13 **a** $r(t) = (\cos(2t) + 1) \mathbf{i} + (\sin(2t) - 1) \mathbf{j}$
b $(x-1)^2 + (y+1)^2 = 1$
c $t = \frac{\pi}{4}, \frac{5\pi}{4}$
- 14 **a** $\frac{28}{g} \text{ seconds}$ **b** $y = \frac{\sqrt{3}}{3}x - \frac{g}{1176}x^2$
c $\frac{98}{g} = 10 \text{ metres}$
- 15 $3\sqrt{5}$

Multiple-choice questions

- 1 C 2 E 3 C 4 A 5 C
6 B 7 B 8 C 9 A 10 D
11 E 12 E 13 B 14 B 15 B
16 B 17 E 18 A 19 D 20 A
21 E 22 B 23 D 24 D 25 E
26 C 27 E 28 C 29 D 30 D
31 A 32 C 33 D 34 C 35 E
36 E 37 D 38 D 39 C

Extended-response questions

- 1 **a** $2\mathbf{i} - 10\mathbf{j} \text{ m/s}$ **b** $\dot{r}_1(t) = 2\mathbf{i} - 2t\mathbf{j}$
c $\mathbf{i} - 3\mathbf{j}$ **d** $t = 0$ **e** 5 s
f Yes; $t = 2$

- 2 **a** $\frac{2 - \sin \alpha}{\cos \alpha}$
b **i** $\frac{g}{2}$ **ii** $\frac{2\sqrt{10}}{7} \text{ seconds}$
- 3 **a** $r = (\cos(4t) - 1) \mathbf{i} + (\sin(4t) + 1) \mathbf{j}$
b $-\mathbf{i} + \mathbf{j}$ **c** $\dot{r} \cdot \ddot{r} = 0$
- 4 **a** $6\pi \text{ s}$
b **i** $-(3\sqrt{3}\mathbf{i} + 2.25\mathbf{j})$ **ii** $\mathbf{i} - \frac{3\sqrt{3}}{4}\mathbf{j}$
c **i** $1.5\sqrt{9 + 7 \sin^2 \left(\frac{t}{3}\right)}$
ii $t = 3\left(\frac{\pi}{2} + n\pi\right), n \in \mathbb{N} \cup \{0\}$
d $\ddot{r} = -\frac{1}{9}r, t = 3n\pi, n \in \mathbb{N} \cup \{0\}$
- 5 **b** $0.1064 \text{ m/s}^2; 30.065 \text{ N}$
- 6 **a** **i** $\frac{3}{2} \sin(2t) \mathbf{i} - 2 \cos(2t) \mathbf{j}$
ii $-6 \sin(2t) \mathbf{i} + 8 \cos(2t) \mathbf{j}$
iii $t = \frac{n\pi}{4}, n \in \mathbb{N} \cup \{0\}$
iv $16x^2 + 9y^2 = 36$
b $a = \frac{(2n+1)\pi}{4}, n \in \mathbb{N} \cup \{0\}$
- 7 **a** $\frac{g}{4}$ **b** $\frac{3g}{4} \text{ N}$ **c** $\frac{\sqrt{2g}}{2}$ **d** 0.904 s
- 8 **b** **i** $r_2 = (0.2t - 1.2) \mathbf{i} + (-0.2t + 3.2) \mathbf{j} + \mathbf{k}$
ii $t = 16$ at $2\mathbf{i} + \mathbf{k}$
- 9 **a** **ii** $10 \text{ m/s}^2, 75t - 5t^2$
b 281.25 m
c **i** 180 m
- 10 **a** **i** $h\mathbf{j}$, for $0\mathbf{i} + 0\mathbf{j}$ at the base of the cliff
ii $V \cos \alpha \mathbf{i} + V \sin \alpha \mathbf{j}$
b **i** $V \cos \alpha \mathbf{i} + (V \sin \alpha - gt) \mathbf{j}$
ii $Vt \cos \alpha \mathbf{i} + \left(h + Vt \sin \alpha - \frac{gt^2}{2}\right) \mathbf{j}$
c $\frac{V \sin \alpha}{g}$

- 11 **c** **i** $-(\mathbf{i} + \mathbf{j}), \mathbf{0}$ **iii** $(-0.43, -0.68)$
- 12 **a** **i** 9504 N **ii** 704 N
b 0.6742 s
c About 10 people (852 kg)

- 13 **a** **i** T_1 **ii** t_0
b **ii** $\frac{2\sqrt{5}}{5} V t_0$

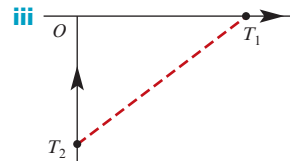

- 14 **a** $\frac{\sqrt{2dm(F - mg\mu)}}{m}$
b **i** μg **ii** $\frac{\sqrt{2dm(F - mg\mu)}}{3m}$
c $F = 10m\mu g$

- 15 a** $\sqrt{g(2h+d)}$ m/s **b** $\sqrt{\frac{d}{2(2h+d)}}$
- 16 a i** $0\mathbf{i} + 0\mathbf{j}$ **ii** $10\mathbf{i} + 10\sqrt{3}\mathbf{j}$, 20, 60°
iii $-9.8\mathbf{j}$
- b i** $\frac{x}{10}$ **ii** $x\mathbf{i} + (x\sqrt{3} - 0.049x^2)\mathbf{j}$
iii $10\mathbf{i} + (10\sqrt{3} - 0.98x)\mathbf{j}$
iv $-8\mathbf{i} + (10\sqrt{3} - 0.98x)\mathbf{j}$
- c i** $-8\mathbf{i} + (10\sqrt{3} - 0.98x - 9.8t_1)\mathbf{j}$
ii $\mathbf{r} = (x - 8t_1)\mathbf{i} + (x\sqrt{3} - 0.049x^2 + t_1(10\sqrt{3} - 0.98x - 4.9t_1))\mathbf{j}$
- d** $\frac{20\sqrt{3} - 0.98x}{9.8}$
- e** 15.71 m
- 17 a** $5\mathbf{i}$
- b i** $(5 - 3t_1)\mathbf{i} + 2t_1\mathbf{j} + t_1\mathbf{k}$,
 $(5 - 3t_2)\mathbf{i} + 2t_2\mathbf{j} + t_2\mathbf{k}$
ii $-3(t_2 - t_1)\mathbf{i} + 2(t_2 - t_1)\mathbf{j} + (t_2 - t_1)\mathbf{k}$
- c** $-3\mathbf{i} + 2\mathbf{j} + \mathbf{k}$
- d i** 36.70° **ii** 13.42
- 18 a** $y = 5 - 2x, x \leq 2$
- b i** $\mathbf{r}_1(t) = 2\mathbf{i} + \mathbf{j} + t(-\mathbf{i} + 2\mathbf{j})$
ii $\mathbf{a} = 2\mathbf{i} + \mathbf{j}$ is the starting position;
 $\mathbf{b} = -\mathbf{i} + 2\mathbf{j}$ is the velocity
- c i** $-13\mathbf{i} + 6\mathbf{j}$ **ii** $5\sqrt{10}$
- 19 a** $13\mathbf{i} + \mathbf{j} + 5\mathbf{k}$
- b** $\frac{\sqrt{14}}{14}(-3\mathbf{i} + \mathbf{j} + 2\mathbf{k}), \frac{\sqrt{6}}{6}(2\mathbf{i} + \mathbf{j} - \mathbf{k})$
- c** 40.20° **d** $7\mathbf{i} + 3\mathbf{j} + 9\mathbf{k}$
- e** $13\mathbf{i} - \mathbf{j} - 8\mathbf{k} + t(-5\mathbf{i} + 3\mathbf{k})$ **f** $\frac{\sqrt{1190}}{34}$
- 20 a** $\frac{6}{5}(4\mathbf{i} + 3\mathbf{j})$
- b i** $\frac{1}{5}(-11\mathbf{i} + 28\mathbf{j})$ **ii** $\frac{1}{5}(13\mathbf{i} + 46\mathbf{j})$
iii $-7\mathbf{i} + 2\mathbf{j} + \frac{6}{5}t(4\mathbf{i} + 3\mathbf{j})$
- c i** $\frac{1}{5}(29\mathbf{i} + 58\mathbf{j})$ **ii** $\frac{8}{3}$ hours
iii $\frac{1}{5}\sqrt{(15 + 11t)^2 + (27t - 15)^2}$
iv 3.91 km

Chapter 19

Exercise 19A

- 1 a** $C = 450 + 0.5X$
- b**
- | | | | |
|--------------|------|------|------|
| C | 950 | 1200 | 1450 |
| $\Pr(C = c)$ | 0.05 | 0.15 | 0.35 |
-
- | | | | |
|--------------|------|------|------|
| C | 1700 | 1950 | 2450 |
| $\Pr(C = c)$ | 0.25 | 0.15 | 0.05 |
- c** 0.05

- 2 a** $W = 2.5X - 5$
- b**
- | | | | | |
|--------------|---------------|---------------|---------------|---------------|
| W | -5 | -2.5 | 0 | 2.5 |
| $\Pr(W = w)$ | $\frac{1}{8}$ | $\frac{3}{8}$ | $\frac{3}{8}$ | $\frac{1}{8}$ |
- c** $\frac{1}{8}$
- 3 a** 0.027 **b** 0.125
- 4 a** 0.3827 **b** 0.2929
- 5 a** 0.5078 **b** 1
- 6 a** $E(Y) = 77, \text{Var}(Y) = 81$
b $E(U) = -45, \text{sd}(U) = 6$
c $E(V) = -8.5, \text{Var}(V) = 2.25$
- 7 a** $E(X) = 0.4$ **b** $\text{Var}(X) = 0.2733$
c $E(4X + 2) = 3.6, \text{sd}(4X + 2) = 2.0913$
- 8 a**
- | | | | | | |
|--------------|---------------|---------------|----------------|---------------|---------------|
| S | 3 | 4 | 5 | 6 | 7 |
| $\Pr(S = s)$ | $\frac{1}{6}$ | $\frac{1}{9}$ | $\frac{7}{18}$ | $\frac{2}{9}$ | $\frac{1}{9}$ |
- b** 5 **c** $\frac{2}{3}$
- 9 a** $\frac{1}{6}$ **b** $\frac{1}{36}$
- 10** 0.45
- 11 a** $E(X_1) = 3$ **b** $\text{Var}(X_1) = 2$
c $E(X_1 - X_2) = 0$ **d** $\text{Var}(X_1 - X_2) = 4$
- 12 a** 39 **b** 16 **c** 36 **d** 16 **e** 8
- 13** Mean 49 mins, sd 8.5446 mins
- 14** Mean 195 mL, sd 11.1803 mL
- 15** Mean 4250 g, sd 20.6155 g

Exercise 19B

- 1** 0.3446 **2** 0.0548
- 3** 0.3410 **4** 0.4466
- 5** 0.0771 **6** 7 people
- 7** 0.01267
- 8 a** 0.0019 **b** 0.0062
- 9** 0.6554

Exercise 19C

- 1** Answers will vary **2** Answers will vary

Exercise 19D

- 1 a** 0.0478
b 0.0092
c Much smaller probability for the mean than for an individual
- 2** Mean 74, sd 4.6188
- 3** Mean 25.025, sd 0.0013
- 4 a** 0.0912
b 0.0105
c Much smaller probability for the mean than for an individual
- 5 a** Answers will vary
b Mean = 1, sd = 0.002

- 6 0.0103 7 0.0089
 8 0.0478 9 0.0014
 10 0.0786 11 0.0127

Exercise 19E

- 1 a 0.5 b 0.0288
 2 0.0008
 3 0.0228
 4 a 0.7292 b 0.9998
 5 0.0092
 6 0.8426
 7 0.000005
 8 a 0.7745 b 0.7997

Exercise 19F

- 1 (6.84, 7.96) 2 (26.67, 38.67)
 3 (14.51, 14.69)
 4 a (24.75, 26.05) b (25.01, 25.79)
 c Larger sample size gives narrower interval
 5 (67.86, 74.34) 6 (127.23, 132.77)
 7 (2.82, 5.23) 8 (27.54, 31.46)
 9 (22.82, 25.55) 10 (35.32, 43.68)
 11 (3.14, 3.43) 12 97
 13 62 14 97
 15 217
 16 a 217 b 865 c Increased by a factor of 4
 17 90%: (30.77, 40.63); 95%: (29.82, 41.58);
 99%: (27.97, 43.43)
 18 d 9 e 0.3487
 19 d 8 e 0.1074
 20 (105.3, 134.7)
 21 (80.814, 84.386)
 22 (45 146, 48 302)

Chapter 19 review

Short-answer questions

- 1 a $E(Y) = 31$, $\text{Var}(Y) = 100$
 b $E(U) = -35$, $\text{sd}(U) = 15$
 c $E(V) = -39$, $\text{Var}(V) = 400$
 2 a 0.45 b $\frac{9}{14}$
 3 Mean 65, $\text{sd} \frac{7}{\sqrt{10}}$
 4 a 155 b 155 ± 19.6
 5 a 217
 b Decrease margin of error by a factor of $\sqrt{2}$
 6 a 57 b $(0.95)^{60}$

Multiple-choice questions

- 1 C 2 E 3 A 4 B 5 C
 6 A 7 B 8 D 9 A 10 E
 11 C 12 B 13 A 14 C

Extended-response questions

- 1 a 0.3807
 b $a = 20.8$, $b = 99.2$
 c i 0.2512 ii 0.2512 iii 0.2847
 d $c = 42.47$, $d = 77.53$
 2 $\mu = 7.37$, $\sigma = 1.72$
 3 a 0.0062 b 0.000088
 c 0.000032 d 0.0075
 4 a i 0.8243 ii 0.9296
 b i (11.45, 13.55) ii (12.84, 14.17)
 iii (12.65, 13.78) iv 89
 5 a i A: (14.51, 16.09)
 ii B: (11.07, 13.13)
 iii Yes, industry A seems more satisfied
 b i 3.2
 ii 0.6602
 iii (1.91, 4.49)
 iv On average, industry A workers score from 1.9 to 4.5 points higher than industry B workers

Chapter 20

Short-answer questions

- 1 $f^{-1}: \mathbb{R} \setminus \{3\} \rightarrow \mathbb{R}$, $f^{-1}(x) = \frac{x}{2(x-3)}$
 2 a $g^{-1}(x) = \frac{1}{2} \ln(3-x)$, $\text{dom } g^{-1} = (-\infty, 3)$

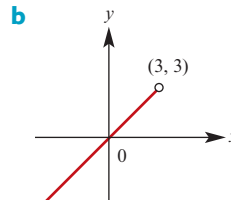

- 4 $\frac{4\sqrt{91}}{9}$
 5 $\mathbf{r} = -\frac{3}{10}(2t-115)\mathbf{i} + \frac{1}{10}(2t+35)\mathbf{j} + t\mathbf{k}$
 6 $\frac{3\sqrt{2}}{5}$
 7 $m \in \mathbb{R} \setminus \{\frac{2}{3}, 2\}$
 8 $\frac{1}{22}$
 9 a $[0, 1]$ b $[0, 4\pi]$
 c 2π d $\frac{1}{2}\left(1 - \frac{1}{\sqrt{2}}\right)$
 e $y = 4 + 2\pi - 8x$
 10 a 20 mins
 b $\frac{dm}{dt} = -\frac{3m}{20-t}$, $m(0) = 10$
 c $m = \frac{(20-t)^3}{800}$
 d $20 - 8\sqrt{5}$ mins

- 11 a** $y = 0$
b $\left(-3 - 2\sqrt{3}, \frac{1}{2} - \frac{1}{\sqrt{3}}\right), \left(-3 + 2\sqrt{3}, \frac{1}{2} + \frac{1}{\sqrt{3}}\right)$
c $\frac{\pi}{\sqrt{3}} + \ln 2$
- 12 a i** $19 + 9i$ **ii** $-7 - \sqrt{3}i$
iii $-\frac{11}{8} - \frac{1}{4}i$ **iv** $1.48 + 0.8i$
- b i** $(ab - 1) + (a + b)i$
ii $b = \frac{a + 1}{a - 1}$
iii

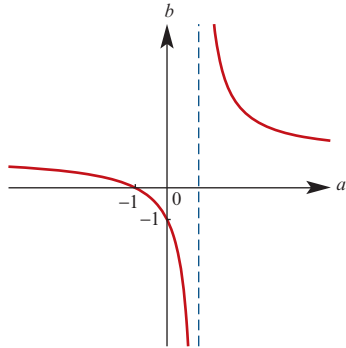

- 13 a** $P\left(e, \frac{1}{e}\right), Q(1, 0)$ **b** $\frac{1}{2}$
- 14 a** 41 **b** 16 **c** 36 **d** 16 **e** 8
- 15 a** $y = -\ln(e + e^{-1} - e^x)$
b $(-\infty, \ln(e + e^{-1}))$
c $y = \frac{x}{e + e^{-1} - 1} - \ln(e + e^{-1} - 1)$
- 16 a** $y = 2 \tan\left(x^2 + \frac{\pi}{4}\right)$ **b** $\left(-\frac{\sqrt{\pi}}{2}, \frac{\sqrt{\pi}}{2}\right)$
c $y = -\frac{x}{8}\sqrt{\frac{3}{\pi}} + 2\sqrt{3} + \frac{1}{16}$
- 17 a** $\frac{1}{(1-x)^2} - \frac{1}{1-x}$ **b** $\frac{2}{3} + \ln 3$
- 18 b** $\pi\left(\frac{a^2}{2} + a + \ln(a - 1) + 4\right)$
- 19** Axis intercepts $(-2, 0), (1, 0)$;
 Asymptotes $x = 0, y = x + 3$;
 Local maximum $(-2, 0)$

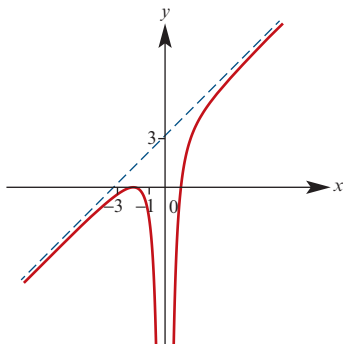

- 20 a** $\pm \frac{1}{\sqrt{2}}(i - j)$
b $m + n = 1; \vec{OP} = mi + (1 - m)j$
c $m = \frac{3 \pm \sqrt{3}}{6}$
- 21 a** $-\frac{2}{9}$ **b** -4
- 22 a** $a = 1, b = 1$ **b** $c = 3, d = 2$
- 23** $\frac{\sqrt{69}}{2}$
- 24** $\arccos\left(\frac{1}{11}\right)$
- 25 a** $\ddot{x} = -4(x - 2)$
b i π s **ii** 1 m **iii** 2 m/s
- 26 a** $2(x - 4)e^x$ **b** $\frac{1}{4}x^2(2 \ln(2x) - 1)$
c $\frac{1}{3}x \tan(3x) + \frac{1}{9} \ln(\cos(3x))$
d $-\frac{1}{2}x^2 + x \tan x + \ln(\cos x)$
- 27 a** $\frac{1}{9}(1 + 2e^3)$ **b** $-\frac{1}{9}$
c $-3(3 + \sqrt{3}) + 3\sqrt{3}\pi$
- 28 a** $\frac{1}{3}$ **b** $\frac{1}{6}$ **c** $\frac{7}{3}$ **d** 0
- 29** Normal distribution with mean 45 and sd 0.5

Multiple-choice questions

- 1** A **2** A **3** A **4** B **5** A
6 B **7** D **8** B **9** E **10** A
11 D **12** E **13** B **14** A **15** B
16 C **17** D **18** A **19** D **20** D
21 B **22** D **23** A **24** E **25** A
26 B **27** D **28** A **29** A **30** B
31 D **32** E **33** C **34** E **35** C
36 E **37** D **38** E **39** A **40** A
41 B **42** A **43** D

Extended-response questions

- 1 a** $r = 2i + j + 2k + t(j - k)$
b $r \cdot (i + 2j + 2k) = 9$ **d** 1.43
e $2i - 3j + 2k; 61.9^\circ$
- 2 b** $(-2, 4, 3)$ **c** $-x + 2y + z = 13$
d $\left(\frac{4}{3}, \frac{7}{3}, \frac{29}{3}\right)$
e $r = -2i + 4j + 3k + t(2i - j + 4k)$
- 3 a** $r = 2i + j + 4k + t(2i + 3j)$ **b** $(0, -2, 4)$
c 21.85° **d** $(0, -2, 7)$
- 4** $\mu = 1.001, \sigma = 0.012$
- 5 a** $k_1 = 40.8, k_2 = 119.2$
b $c_1 = 71.2, c_2 = 88.8$
c $(76.2, 93.8)$
- 6 a** 0.5 **b** 0.5
c Mean 200 cm; variance 0.508 cm²
- 7 a** $f'(x) = \ln(x) - 2$ **b** $A(e^3, 0)$
c $y = x - e^3$ **d** 2 : 1

8 a i $\frac{dy}{dx} = \frac{(b^2 - a^2) \cos x}{(b + a \sin x)^2}$ ii 1, -1

b i $(0, \frac{1}{2})$

ii $(-\frac{5\pi}{6}, 0), (-\frac{\pi}{6}, 0), (\frac{7\pi}{6}, 0), (\frac{11\pi}{6}, 0)$

iii $(-\frac{\pi}{2}, -1), (\frac{\pi}{2}, 1), (\frac{3\pi}{2}, -1)$

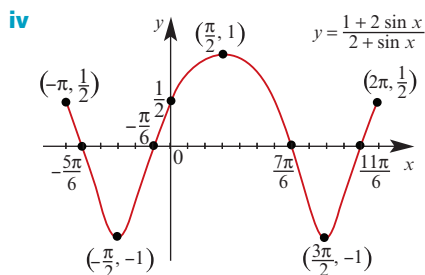

v $2\pi(3 - \sqrt{3})$

9 a $r = 2, a = \frac{\pi}{3}$ b $[-2, 2]$ c $(0, 1)$

d $(\frac{5\pi}{6}, 0), (\frac{11\pi}{6}, 0)$ e $\frac{\pi}{12}, \frac{7\pi}{12}$

f $\frac{\ln(21 + 12\sqrt{3})}{4}$ g $(10\pi + 3\sqrt{3})\frac{\pi}{6}$

10 a i $\int_{10}^5 \frac{-50}{v(1+v^2)} dv$ ii $25 \ln(\frac{104}{101})$ seconds

b ii $x = 50(\tan^{-1}(10) - \tan^{-1} v)$ iv 74 m

11 a i $\cos(\pi x) - \pi x \sin(\pi x)$

ii $\frac{1}{\pi^2} \sin(\pi x) - \frac{x}{\pi} \cos(\pi x)$

b i $p = \pi$

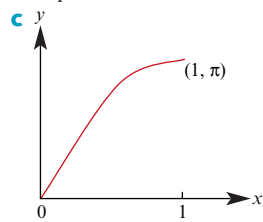

d $\frac{(2\pi^2 + 15)\pi}{6}$ e $k = 2$

f 1.066 g 0.572

12 a i $3g - T = 3b, T - 2g = 4b$

ii $b = \frac{g}{7}, T = \frac{18g}{7}$

b i $3 - 0.1t$ kg

ii $(3 - 0.1t)g - T_1 = (3 - 0.1t)a$

iii $T_1 - 2g = 4a$ iv $a = \frac{(1 - 0.1t)g}{7 - 0.1t}$

c $\frac{dv}{dt} = \frac{(1 - 0.1t)g}{7 - 0.1t}, v = gt + 60g \ln(\frac{7 - 0.1t}{7})$

d 18.999

e 93.188 m

13 a i $24\sqrt{3}$

ii $-2\sqrt{3}, \sqrt{3} + 3i$

b

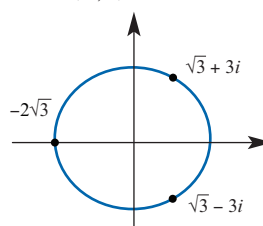

c ii $\sqrt{3} \pm 6i$

iii $\frac{(x - \sqrt{3})^2}{27} + \frac{y^2}{36} = 1$

14 a $m = \sqrt{3}$

b i $\vec{OC} = -\vec{OA}$

c ii $2i - j + 2k$ and $\frac{8}{3}i - \frac{1}{3}j + \frac{4}{3}k$

d $\frac{3}{\sqrt{18 - 2\sqrt{3}}}((2 + \sqrt{3})i + (-1 + \sqrt{3})j + (2 - \sqrt{3})k)$

e $t = \frac{3}{4}, k = \frac{1}{2}, \ell = \frac{13\sqrt{3}}{12}$

f Particle lies outside the circle

15 a i $\frac{x^2}{9} + \frac{(y+a)^2}{36} = 1$

ii $\pm \frac{\sqrt{36 - a^2}}{2}$

b $f(x) = 2\sqrt{9 - x^2} - a$

c $\sqrt{9 - x^2} - \frac{x^2}{\sqrt{9 - x^2}}$

d i $A = 9$

e $\frac{1}{2}(x\sqrt{9 - x^2} + 9 \arcsin(\frac{x}{3}))$

f $18 \arcsin(\frac{\sqrt{36 - a^2}}{6}) - \frac{a}{2}\sqrt{36 - a^2}$

g 18π

h 144π

16 a $y^2 = x(\frac{x}{3} - 1)^2$ b $(1, \frac{2}{3}), (1, -\frac{2}{3})$

c $\frac{8\sqrt{3}}{5}$

d $\frac{3\pi}{4}$

17 a $y^2 = 16x^2(1 - x^2)(1 - 2x^2)^2$

b $\frac{dx}{dt} = \cos t, \frac{dy}{dt} = 4 \cos(4t), \frac{dy}{dx} = \frac{4 \cos(4t)}{\cos t}$

c i $\frac{\pi}{8}, \frac{3\pi}{8}, \frac{5\pi}{8}, \frac{7\pi}{8}, \frac{9\pi}{8}, \frac{11\pi}{8}, \frac{13\pi}{8}, \frac{15\pi}{8}$

ii $-\frac{1}{2}\sqrt{2-\sqrt{2}}, -\frac{1}{2}\sqrt{2+\sqrt{2}}, \frac{1}{2}\sqrt{2-\sqrt{2}}, \frac{1}{2}\sqrt{2+\sqrt{2}}$

iii $(-\frac{1}{2}\sqrt{2-\sqrt{2}}, 1), (-\frac{1}{2}\sqrt{2-\sqrt{2}}, -1),$
 $(-\frac{1}{2}\sqrt{2+\sqrt{2}}, 1), (-\frac{1}{2}\sqrt{2+\sqrt{2}}, -1),$
 $(\frac{1}{2}\sqrt{2-\sqrt{2}}, 1), (\frac{1}{2}\sqrt{2-\sqrt{2}}, -1),$
 $(\frac{1}{2}\sqrt{2+\sqrt{2}}, 1), (\frac{1}{2}\sqrt{2+\sqrt{2}}, -1)$

iv $\frac{dy}{dx} = \pm 4$ when $x = 0$;

$\frac{dy}{dx} = \pm 4\sqrt{2}$ when $x = \pm \frac{1}{\sqrt{2}}$

d $\frac{16}{15}(\sqrt{2}+1)$ **e** $\frac{64\pi}{63}$

18 a $y^2 = \frac{64x^2(25-x^2)}{25}$

b i ± 8 **ii** $\pm \frac{14}{5}$

c i $\frac{\pi\sqrt{2}}{12}$ **ii** $\frac{\pi\sqrt{2}}{12}$

d $\frac{800}{3}$ **e** $\frac{325}{16}$ **f** $\frac{6400\pi}{3}$

19 a $f'(x) = \frac{x^4 + 3ax^2}{(x^2 + a)^2}, f''(x) = \frac{6a^2x - 2ax^3}{(x^2 + a)^3}$

b $(0, 0)$ stationary point of inflection

c $(-\sqrt{3a}, \frac{-3\sqrt{3a}}{4}), (\sqrt{3a}, \frac{3\sqrt{3a}}{4})$

d $y = x$

e

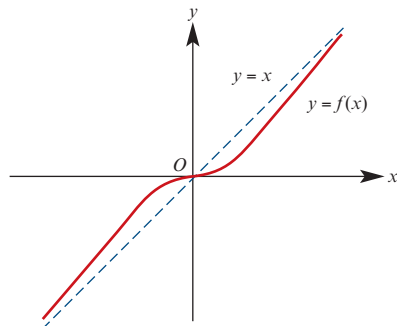

f $a = 1$

20 a $f'(x) = \frac{x^4 - 3ax^2}{(x^2 - a)^2}, f''(x) = \frac{6a^2x + 2ax^3}{(x^2 - a)^3}$

b $(-\sqrt{3a}, \frac{-3\sqrt{3a}}{2})$ local maximum,

$(\sqrt{3a}, \frac{3\sqrt{3a}}{2})$ local minimum,

$(0, 0)$ stationary point of inflection

c $(0, 0)$

d $y = x, x = \sqrt{a}, x = -\sqrt{a}$

e

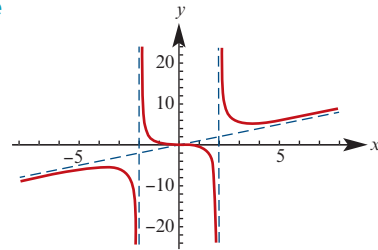

f $a = 16$

21 a $\frac{x}{\sqrt{1-x^2}} + \arcsin(x), (0, 0)$ local minimum

(Note: It is easy to see $f(x) \geq 0$ for all x , as x and $\arcsin(x)$ have the same sign for all x , and $f(x) = 0$ if and only if $x = 0$.)

b $\frac{x^2\sqrt{1-x^2} + 2(1-x^2)^{\frac{3}{2}}}{(x^2-1)^2} =$

$\frac{\sqrt{1-x^2}(2-x^2)}{(x^2-1)^2} \geq 0$ for all $x \in (-1, 1)$

c $f(x) \geq 0$ for all x , as x and $\arcsin(x)$ have the same sign for all x

d $x = 0$ and $x = 1$

e

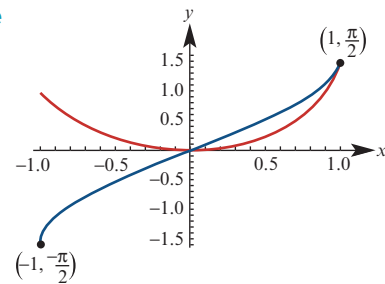

f $\frac{3\pi}{8} - 1$

22 a $x = \frac{3}{4} \sin(2t), y = -\frac{1}{2} \cos(2t)$

b $\frac{16x^2}{9} + 4y^2 = 1$ **c** $\frac{2}{3} \tan(2t)$

d $y = -\frac{1}{2} \sec(2t), x = \frac{3}{4} \operatorname{cosec}(2t)$

e $\frac{3}{8} |\operatorname{cosec}(4t)|$, minimum area = $\frac{3}{8}$ when

$t = \dots, -\frac{3\pi}{8}, -\frac{\pi}{8}, \frac{\pi}{8}, \frac{3\pi}{8}, \dots$

f $x = \frac{3}{4} \sin(2t), y = \frac{3}{4} \cos(2t)$

(infinitely many possible answers)

g $\frac{5\pi}{16}$